

A Technology Roadmap for Generation IV Nuclear Energy Systems

December 2002

Ten Nations Preparing Today for Tomorrow's Energy Needs

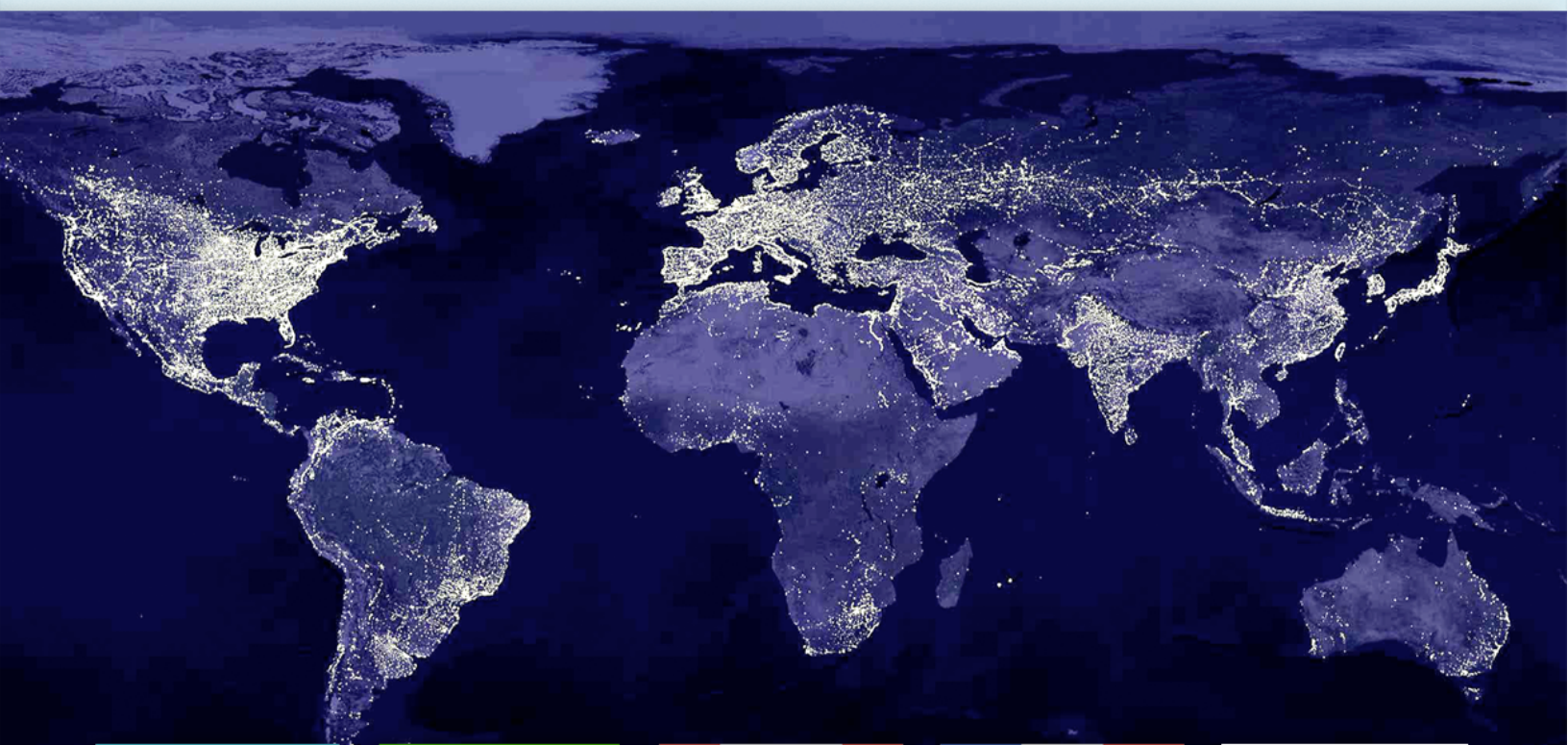

Issued by the
U.S. DOE Nuclear Energy Research Advisory Committee
and the Generation IV International Forum

DISCLAIMER

This information was prepared as an account of work by the U.S. Nuclear Energy Research Advisory Committee (NERAC) and the Generation IV International Forum (GIF). Neither the NERAC nor any of its members, nor the GIF, nor any of its members, nor any GIF member's national government agency or employee thereof, makes any warranty, express or implied, or assumes any legal liability or responsibility for the accuracy, completeness, or usefulness of any information, apparatus, product, or process disclosed, or represents that its use would not infringe privately owned rights. References herein to any specific commercial product, process, or service by trade name, trademark, manufacturer, or otherwise, does not necessarily constitute or imply its endorsement, recommendation, or favoring by the NERAC or its members, or the GIF or its members, or any agency of a GIF member's national government. The views and opinions of authors expressed herein do not necessarily state or reflect those of the NERAC or its members, or the GIF, its members, or any agency of a GIF member's national government.

A Technology Roadmap for Generation IV Nuclear Energy Systems

December 2002

*Issued by the
U.S. DOE Nuclear Energy Research Advisory Committee
and the Generation IV International Forum*

Contents

AN ESSENTIAL ROLE FOR NUCLEAR ENERGY	1
The Long-Term Benefits from Nuclear Energy’s Essential Role	1
Meeting the Challenges of Nuclear Energy’s Essential Role	2
THE GENERATION IV TECHNOLOGY ROADMAP IN BRIEF	5
An International Effort	5
Goals for Generation IV	6
The Generation IV Roadmap Project	8
Evaluation and Selection Methodology	9
Generation IV Nuclear Energy Systems	11
FINDINGS OF THE ROADMAP	13
Fuel Cycles and Sustainability	13
Descriptions of the Generation IV Systems	14
Missions and Economics for Generation IV	16
Safety, Safeguards, and Public Confidence in Generation IV	18
Near-Term Deployment Opportunities and Generation IV	18
RECOMMENDED R&D FOR THE MOST PROMISING SYSTEMS	21
Introduction	21
Gas-Cooled Fast Reactor System R&D	22
Lead-Cooled Fast Reactor System R&D	27
Molten Salt Reactor System R&D	33
Sodium-Cooled Fast Reactor System R&D	38
Supercritical-Water-Cooled Reactor System R&D	42
Very-High-Temperature Reactor System R&D	48
RECOMMENDED CROSSCUTTING R&D	53
Crosscutting Fuel Cycle R&D	53
Crosscutting Fuels and Materials R&D	60
Crosscutting Energy Products R&D	65
Crosscutting Risk and Safety R&D	69
Safety and Reliability Evaluation and Peer Review	71
Crosscutting Economics R&D	71
Crosscutting Proliferation Resistance and Physical Protection R&D	75
INTEGRATION OF R&D PROGRAMS AND PATH FORWARD	79
Introduction	79
Overall Advancement of Generation IV	79
R&D Programs for Individual Generation IV Systems	79
Comparison of R&D Timelines	82
Program Implementation	82
Integration Issues and Opportunities	82
MEMBERS OF THE GENERATION IV ROADMAP PROJECT	85
ACRONYMS	90

AN ESSENTIAL ROLE FOR NUCLEAR ENERGY

The world's population is expected to expand from about 6 billion people to 10 billion people by the year 2050, all striving for a better quality of life. As the Earth's population grows, so will the demand for energy and the benefits that it brings: improved standards of living, better health and longer life expectancy, improved literacy and opportunity, and many others. Simply expanding energy use using today's mix of production options, however, will continue to have adverse environmental impacts and potential long-term consequences from global climate change. For the Earth to support its population, we must increase the use of energy supplies that are clean, safe, and cost-effective. Prominent among these supplies is nuclear energy.

There are currently 438 nuclear power plants in operation around the world, producing 16% of the world's electricity—the largest share provided by any nongreenhouse-gas-emitting source. This yields a significant reduction in the environmental impact of today's electric generation. To continue this benefit, new systems will be needed to replace plants as they retire. In the latter part of this century, the environmental benefits of nuclear energy can expand and even extend to other energy products besides electricity. For example, nuclear energy can be used to generate hydrogen for use in petroleum refinement and as a transportation fuel to reduce the dependence upon oil, and to desalinate water in areas where fresh water is in short supply. To deliver this benefit, new systems will be needed, requiring near-term deployment of nuclear plants and significant research and development (R&D) on next-generation systems.

Many of the world's nations, both industrialized and developing, believe that a greater use of nuclear energy will be required if energy security is to be achieved. They are confident that nuclear energy can be used now and in the future to meet their growing demand for energy safely and economically, with certainty of long-term supply and without adverse environmental impacts.

To enhance the future role of nuclear energy systems, this technology roadmap defines and plans the necessary R&D to support a generation of innovative nuclear energy systems known as Generation IV. Generation IV nuclear energy systems comprise the nuclear reactor and its energy conversion systems, as well as the necessary facilities for the entire fuel cycle from ore extraction to final waste disposal.

The Long-Term Benefits from Nuclear Energy's Essential Role

Challenging technology goals for Generation IV nuclear energy systems are defined in this roadmap in four areas: sustainability, economics, safety and reliability, and proliferation resistance and physical protection. By striving to meet the technology goals, new nuclear systems can achieve a number of long-term benefits that will help nuclear energy play an essential role worldwide.

Sustainable Nuclear Energy

Sustainability is the ability to meet the needs of the present generation while enhancing the ability of future generations to meet society's needs indefinitely into the future. In this roadmap, sustainability goals are defined with focus on waste management and resource utilization. Other factors that are commonly associated with sustainability, such as economics and environment,^a are considered separately in the technology roadmap to stress their importance. Looking ahead to the findings of this roadmap, the benefits of meeting sustainability goals include:

- Extending the nuclear fuel supply into future centuries by recycling used fuel to recover its energy content, and by converting ²³⁸U to new fuel
- Having a positive impact on the environment through the displacement of polluting energy and transportation sources by nuclear electricity generation and nuclear-produced hydrogen

^a Internationally, and especially in the context of the recent World Summit on Sustainable Development held in Johannesburg in August 2002, sustainable development is usually examined from three points of view: economic, environmental, and social. Generation IV has adopted a narrower definition of sustainability in order to balance the emphasis on the various goal areas. For a more complete discussion of sustainability, see *NEA News*, No. 19.1, available at the <http://www.nea.fr/html/sd/welcome.html> website.

- Allowing geologic waste repositories to accept the waste of many more plant-years of nuclear plant operation through substantial reduction in the amount of wastes and their decay heat
- Greatly simplifying the scientific analysis and demonstration of safe repository performance for very long time periods (beyond 1000 years), by a large reduction in the lifetime and toxicity of the residual radioactive wastes sent to repositories for final geologic disposal.

Competitive Nuclear Energy

Economics goals broadly consider competitive costs and financial risks of nuclear energy systems. Looking ahead, the benefits of meeting economics goals include:

- Achieving economic life-cycle and energy production costs through a number of innovative advances in plant and fuel cycle efficiency, design simplifications, and plant sizes
- Reducing economic risk to nuclear projects through the development of plants built using innovative fabrication and construction techniques, and possibly modular designs
- Allowing the distributed production of hydrogen, fresh water, district heating, and other energy products to be produced where they are needed.

Safe and Reliable Systems

Maintaining and enhancing the safe and reliable operation is an essential priority in the development of next-generation systems. Safety and reliability goals broadly consider safe and reliable operation, improved accident management and minimization of consequences, investment protection, and reduced need for off-site emergency response. Looking ahead, the benefit of meeting these goals includes:

- Increasing the use of inherent safety features, robust designs, and transparent safety features that can be understood by nonexperts
- Enhancing public confidence in the safety of nuclear energy.

Proliferation Resistance and Physical Protection

Proliferation resistance and physical protection consider means for controlling and securing nuclear material and nuclear facilities. Looking ahead, the benefits of meeting these goals include:

- Providing continued effective proliferation resistance of nuclear energy systems through improved design features and other measures
- Increasing physical protection against terrorism by increasing the robustness of new facilities.

Meeting the Challenges of Nuclear Energy's Essential Role

To play an essential role, future nuclear energy systems will need to provide (1) manageable nuclear waste, effective fuel utilization, and increased environmental benefits, (2) competitive economics, (3) recognized safety performance, and (4) secure nuclear energy systems and nuclear materials. These challenges, described below, are the basis for setting the goals of next-generation nuclear energy systems in this roadmap.

Disposition of discharged fuel or other high-level radioactive residues in a geological repository is the preferred choice of most countries, and good technical progress is being made. Long-term retrievable surface or subsurface repositories are also being assessed. The progress toward realizing a geologic repository in the United States at Yucca Mountain and in other countries like Finland and Sweden demonstrates the viability of repositories as a solution. However, the extensive use of nuclear energy in the future requires the optimal use of repository space and the consideration of closing the fuel cycle.

Today, most countries use the once-through fuel cycle, whereas others close the fuel cycle by recycling. Recycling (using either single or multiple passes) recovers uranium and plutonium from the spent fuel and uses it to make new fuel, thereby producing more power and reducing the need for enrichment and uranium mining. Recycling in a manner that does not produce separated plutonium can further avoid proliferation risks. However, recycling has proven to be uneconomical today, given plentiful supplies of uranium at low and stable prices. This will eventually change, and closing the fuel cycle will be favored when the cost of maintaining an open cycle exceeds that of a closed cycle. With recycling, other benefits are realized: the high-level radioactive residues occupy a much-reduced volume, can be made less toxic, and can be processed into a more suitable form for disposal. In addition, reactors can be designed to transmute troublesome long-lived heavy elements. Achieving these benefits, however, will require significant R&D on fuel cycle technology.

The economic performance of nuclear power has been mixed: On the positive side, the cost of nuclear power generation in many countries is the same as or less than the cost of producing electricity from coal, oil, or natural gas. On the other hand, construction of advanced nuclear energy systems must address their economics in a variety of changing markets and overcome their traditionally high construction costs. While the current generation of plants generates electricity at competitive costs, construction costs are not competitive enough, and licensing needs to be more predictable to stimulate widespread interest in new nuclear construction. Significant R&D is needed to reduce capital costs and construction times for new plants.

Overall, the safety and environmental record of nuclear power is excellent. Despite this, public confidence in the safety of nuclear power needs to be increased. New systems should address this need with clear and transparent safety approaches that arise from R&D on advanced systems.

Fissile materials within civilian nuclear power programs are well-safeguarded by an effective international system. Current-generation plants have robust designs and added precautions against acts of terrorism. Never-

theless, it is desirable for future nuclear fuel cycles and nuclear materials safeguards to design from the start an even higher degree of resistance to nuclear material diversion or undeclared production. Further, questions have arisen about the vulnerability of nuclear plants to terrorist attack. In response, future nuclear energy systems will provide improved physical protection against the threats of terrorism.

This roadmap has been prepared by many experts from countries that have experience developing and operating nuclear reactors and facilities. These experts brought a broad international perspective on the needs and opportunities for nuclear energy in the 21st century. The opportunities for advancing Generation IV systems will also depend on gaining public confidence, which can be enhanced through the openness of the process of developing and deploying Generation IV systems. The findings of this roadmap and the R&D plans that are based on it will be communicated to the public on a regular basis, and opportunities for stakeholder groups to provide feedback on the plans will be offered.

THE GENERATION IV TECHNOLOGY ROADMAP IN BRIEF

An International Effort

To advance nuclear energy to meet future energy needs, ten countries—Argentina, Brazil, Canada, France, Japan, the Republic of Korea, the Republic of South Africa, Switzerland, the United Kingdom, and the United States—have agreed on a framework for international cooperation in research for a future generation of nuclear energy systems, known as Generation IV. The figure below gives an overview of the generations of nuclear energy systems. The first generation was advanced in the 1950s and 60s in the early prototype reactors. The second generation began in the 1970s in the large commercial power plants that are still operating today. Generation III was developed more recently in the 1990s with a number of evolutionary designs that offer significant advances in safety and economics, and a number have been built, primarily in East Asia. Advances to Generation III are underway, resulting in several (so-called Generation III+) near-term deployable plants that are actively under development and are being considered for deployment in several countries. New plants built between now and 2030 will likely be chosen from these plants. Beyond 2030, the prospect for innovative advances through renewed R&D has stimulated interest

worldwide in a fourth generation of nuclear energy systems.

The ten countries have joined together to form the Generation IV International Forum (GIF) to develop future-generation nuclear energy systems that can be licensed, constructed, and operated in a manner that will provide competitively priced and reliable energy products while satisfactorily addressing nuclear safety, waste, proliferation, and public perception concerns. The objective for Generation IV nuclear energy systems is to have them available for international deployment about the year 2030, when many of the world's currently operating nuclear power plants will be at or near the end of their operating licenses.

Nuclear energy research programs around the world have been developing concepts that could form the basis for Generation IV systems. Increased collaboration on R&D to be undertaken by the GIF countries will stimulate progress toward the realization of such systems. With international commitment and resolve, the world can begin to realize the benefits of Generation IV nuclear energy systems within the next few decades.

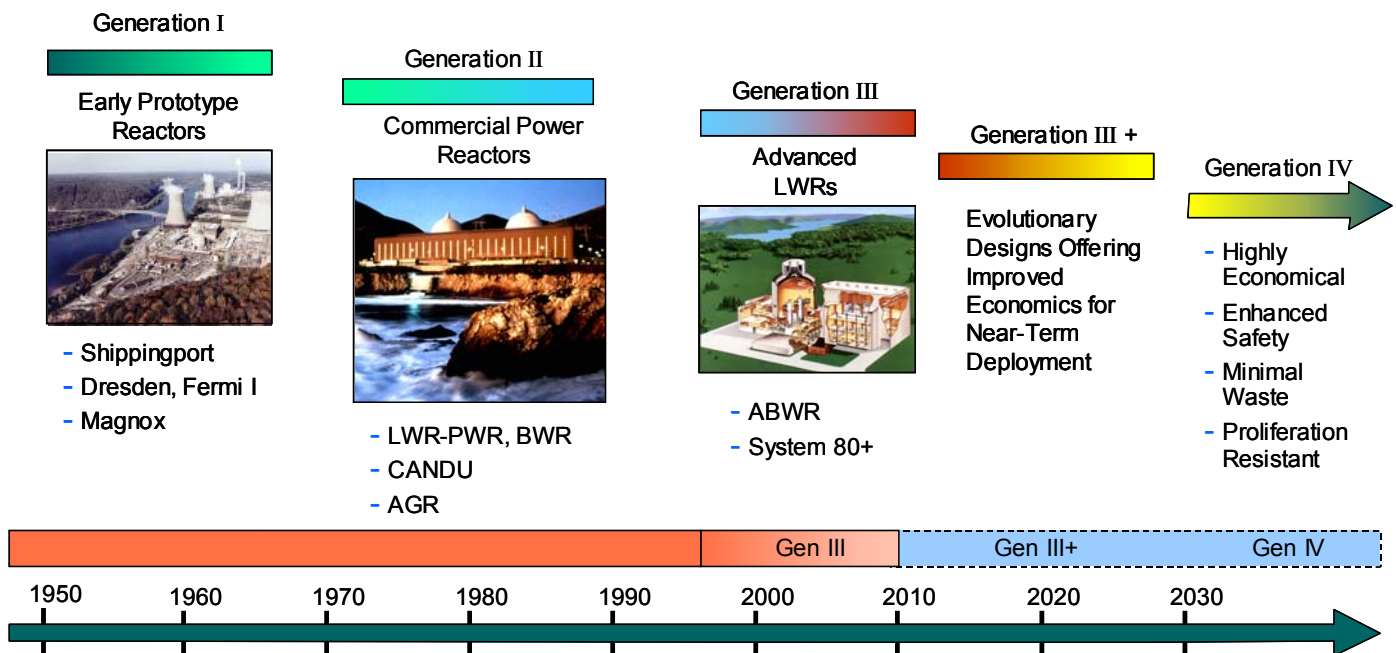

Beginning in 2000, the countries constituting the GIF began meeting to discuss the research necessary to support next-generation reactors. From those initial meetings a technology roadmap to guide the Generation IV effort was begun. The organization and execution of the roadmap became the responsibility of a Roadmap Integration Team that is advised by the Subcommittee on Generation IV Technology Planning of the U.S. Department of Energy's Nuclear Energy Research Advisory Committee (NERAC). Roadmapping is a methodology used to define and manage the planning and execution of large-scale R&D efforts. The GIF agreed to support the preparation of a roadmap, and the roadmap became the focal point of their efforts. More than one hundred technical experts from ten countries have contributed to its preparation.

The scope of the R&D described in this roadmap covers all of the Generation IV systems. However, each GIF country will focus on those systems and the subset of R&D activities that are of greatest interest to them. Thus, the roadmap provides a foundation for formulating national and international program plans on which the GIF countries will collaborate to advance Generation IV systems.

In the United States, the Generation IV Technology Roadmap is complemented by an earlier Near-Term Deployment Roadmap.^b These roadmaps and other planning documents will be the foundation for a set of R&D program plans encompassing the objectives of deploying more mature nuclear energy systems by 2010, developing separations and transmutation technology for reducing existing stores of spent nuclear fuel, and developing next generation nuclear energy systems in the long term.

Goals for Generation IV

As preparations for the Generation IV Technology Roadmap began, it was necessary to establish goals for these nuclear energy systems. The goals have three purposes: First, they serve as the basis for developing criteria to assess and compare the systems in the technology roadmap. Second, they are challenging and stimulate the search for innovative nuclear energy systems—both fuel cycles and reactor technologies. Third, they will serve to motivate and guide the R&D on Generation IV systems as collaborative efforts get underway.

Eight goals for Generation IV [see the box below] are defined in the four broad areas of sustainability, economics, safety and reliability, and proliferation resistance and physical protection. Sustainability goals focus on fuel utilization and waste management. Economics goals focus on competitive life cycle and energy produc-

Goals for Generation IV Nuclear Energy Systems

Sustainability–1 *Generation IV nuclear energy systems will provide sustainable energy generation that meets clean air objectives and promotes long-term availability of systems and effective fuel utilization for worldwide energy production.*

Sustainability–2 *Generation IV nuclear energy systems will minimize and manage their nuclear waste and notably reduce the long-term stewardship burden, thereby improving protection for the public health and the environment.*

Economics–1 *Generation IV nuclear energy systems will have a clear life-cycle cost advantage over other energy sources.*

Economics–2 *Generation IV nuclear energy systems will have a level of financial risk comparable to other energy projects.*

Safety and Reliability–1 *Generation IV nuclear energy systems operations will excel in safety and reliability.*

Safety and Reliability–2 *Generation IV nuclear energy systems will have a very low likelihood and degree of reactor core damage.*

Safety and Reliability–3 *Generation IV nuclear energy systems will eliminate the need for offsite emergency response.*

Proliferation Resistance and Physical Protection–1 *Generation IV nuclear energy systems will increase the assurance that they are a very unattractive and the least desirable route for diversion or theft of weapons-usable materials, and provide increased physical protection against acts of terrorism.*

tion costs and financial risk. Safety and reliability goals focus on safe and reliable operation, improved accident management and minimization of consequences, investment protection, and essentially eliminating the technical need for off-site emergency response. The proliferation resistance and physical protection goal focuses on controlling and securing nuclear material and nuclear facilities. Each broad goal area is briefly discussed below.

^b "A Roadmap to Deploy New Nuclear Power Plants in the United States by 2010, Volume I, Summary Report," U.S. Department of Energy Nuclear Energy Research Advisory Committee Subcommittee on Generation IV Technology Planning, available at the <http://nuclear.gov/nerac/ntdroadmapvolume1.pdf> website, accessed September 2002.

Sustainability is the ability to meet the needs of present generations while enhancing and not jeopardizing the ability of future generations to meet society's needs indefinitely into the future. There is a growing desire in society for the production of energy in accordance with sustainability principles. Sustainability requires the conservation of resources, protection of the environment, preservation of the ability of future generations to meet their own needs, and the avoidance of placing unjustified burdens upon them. Existing and future nuclear power plants meet current and increasingly stringent clean air objectives, since their energy is produced without combustion processes. The two sustainability goals encompass the interrelated needs of improved waste management, minimal environmental impacts, effective fuel utilization, and development of new energy products that can expand nuclear energy's benefits beyond electrical generation.

Economic competitiveness is a requirement of the marketplace and is essential for Generation IV nuclear energy systems. In today's environment, nuclear power plants are primarily baseload units that were purchased and operated by regulated public and private utilities. A transition is taking place worldwide from regulated to deregulated energy markets, which will increase the number of independent power producers and merchant power plant owner/operators. Future nuclear energy systems should accommodate a range of plant ownership options and anticipate a wider array of potential roles and options for deploying nuclear power plants, including load following and smaller units. While it is anticipated that Generation IV nuclear energy systems will primarily produce electricity, they will also help meet anticipated future needs for a broader range of energy products beyond electricity. For example, hydrogen, process heat, district heating, and potable water will likely be needed to keep up with increasing worldwide demands and long-term changes in energy use. Generation IV systems have goals to ensure that they are economically attractive while meeting changing energy needs.

Safety and reliability are essential priorities in the development and operation of nuclear energy systems. Nuclear energy systems must be designed so that during normal operation or anticipated transients safety margins

are adequate, accidents are prevented, and off-normal situations do not deteriorate into severe accidents. At the same time, competitiveness requires a very high level of reliability and performance. There has been a definite trend over the years to improve the safety and reliability of nuclear power plants, reduce the frequency and degree of off-site radioactive releases, and reduce the possibility of significant plant damage. Looking ahead, Generation IV systems will face new challenges to their reliability at higher temperatures and other anticipated conditions. Generation IV systems have goals to achieve high levels of safety and reliability through further improvements. The three safety and reliability goals continue the past trend and seek simplified designs that are safe and further reduce the potential for severe accidents and minimize their consequences. The achievement of these ambitious goals cannot rely only upon technical improvements, but will also require systematic consideration of human performance as a major contributor to the plant availability, reliability, inspectability, and maintainability.

Proliferation resistance and physical protection are also essential priorities in the expanding role of nuclear energy systems. The safeguards provided by the Nuclear Nonproliferation Treaty have been highly successful in preventing the use of civilian nuclear energy systems for nuclear weapons proliferation. This goal applies to all inventories of nuclear materials (both source materials and special fissionable materials) in the system involved in enrichment, conversion, fabrication, power production, recycling, and waste disposal. In addition, existing nuclear plants are highly secure and designed to withstand external events such as earthquakes, floods, tornadoes, plane crashes, and fires. Their many protective features considerably reduce the impact of external or internal threats through the redundancy, diversity, and independence of the safety systems. This goal points out the need to increase public confidence in the security of nuclear energy facilities against terrorist attacks. Advanced systems need to be designed from the start with improved physical protection against acts of terrorism, to a level commensurate with the protection of other critical systems and infrastructure.

The Generation IV Roadmap Project

As the Generation IV goals were being finalized, preparations were made to develop the Generation IV technology roadmap. The organization of the roadmap is shown in the figure at the right. The Roadmap Integration Team (RIT) is the executive group. Groups of international experts were organized to undertake identification and evaluation of candidate systems, and to define R&D to support them.

In a first step, an Evaluation Methodology Group was formed to develop a process to systematically evaluate the potential of proposed Generation IV nuclear

energy systems to meet the Generation IV goals. A discussion of the Evaluation Methodology Group's evaluation methodology is included in this report. At the same time, a solicitation was issued worldwide, requesting that concept proponents submit information on nuclear energy systems that they believe could meet some or all of the Generation IV goals. Nearly 100 concepts and ideas were received from researchers in a dozen countries.

Technical Working Groups (TWGs) were formed—covering nuclear energy systems employing water-cooled, gas-cooled, liquid-metal-cooled, and nonclassical reactor concepts—to review the proposed systems and evaluate their potential using the tools developed by the Evaluation Methodology Group. Because of the large number of system concepts submitted, the TWGs collected their concepts into sets of concepts with similar attributes. The TWGs conducted an initial screening, termed *screening for potential*, to eliminate those concepts or concept sets that did not have reasonable potential for advancing the goals, or were too distant or technically infeasible.

Following the screening for potential, the TWGs conducted a *final screening* to assess quantitatively the potential of each concept or concept set to meet the Generation IV goals. The efforts of the TWGs are

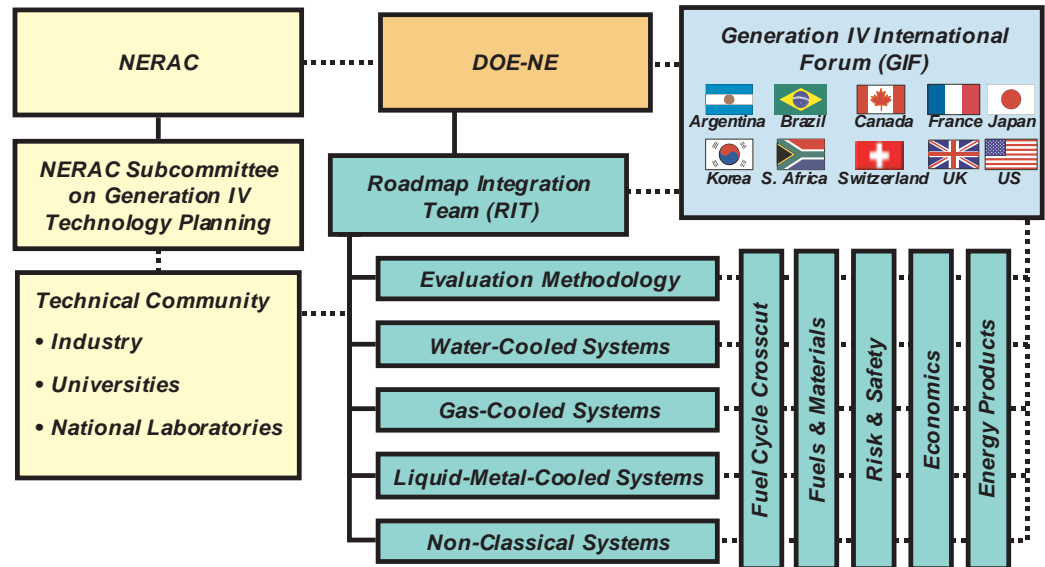

briefly presented in this technical roadmap report. The TWG Reports are included in their entirety on the Roadmap CD-ROM, along with the reports of the other groups.

A Fuel Cycle Crosscut Group (FCCG) was also formed at a very early stage to explore the impact of the choice of fuel cycle on major elements of sustainability—especially waste management and fuel utilization. Their members were equally drawn from the working groups, allowing them to compare their insights and findings directly. Later, other Crosscut Groups were formed covering economics, risk and safety, fuels and materials, and energy products. The Crosscut Groups reviewed the TWG reports for consistency in the technical evaluations and subject treatment, and continued to make recommendations regarding the scope and priority for cross-cutting R&D in their subject areas. Finally, the TWGs and Crosscut Groups worked together to report on the R&D needs and priorities of the most promising concepts.

The international experts that contributed to this roadmap represented all ten GIF countries, the Organisation for Economic Cooperation and Development Nuclear Energy Agency, the European Commission, and the International Atomic Energy Agency.

Evaluation and Selection Methodology

The selection of the systems to be developed as Generation IV was accomplished in the following steps:

1. Definition and evaluation of candidate systems
2. Review of evaluations and discussion of desired missions (national priorities) for the systems
3. Final review of evaluations and performance to missions
4. Final decision on selections to Generation IV and identification of near-term deployable designs.

The first step was the collective work of the roadmap participants and the NERAC Subcommittee on Generation IV Technology Planning over a one-year period. It was concluded with a broad consistency review across the candidate concepts, and reviewed by the Subcommittee in early April 2002. The latter three steps continued to be advised by the Subcommittee but were increasingly taken up by the GIF members in a series of meetings in the first half of 2002, culminating in the selection of six Generation IV systems by the GIF. The entire process is summarized below, beginning with a detailed explanation of the evaluation methodology in the first step.

The use of a common evaluation methodology is a central feature of the roadmap project, providing a consistent basis for evaluating the potential of many concepts to meet the Generation IV goals. The methodology was developed by the Evaluation Methodology Group at an early stage in the project. The basic approach is to formulate a number of factors that indicate performance relative to the goals, called criteria, and then to evaluate concept performance against these criteria using specific measures, called metrics.

Two evaluation stages were employed, screening for potential and final screening. The screening for potential evaluation was designed to eliminate concepts that lacked sufficient potential, based on the TWG's judgment of their performance against the evaluation criteria. The final screening evaluation was performed for concepts that passed the screening for potential and was designed to support selection of a small number of Generation IV concepts. This final screening employed a more detailed and quantitative set of evaluation criteria than the screening for potential. Numerical scales were employed for a number of the criteria, and weights were

assigned to the criteria associated with each goal. The scales were established relative to a representative advanced light water reactor baseline. To complete the selection process, the GIF members considered the evaluations and eventually selected six to become the basis for Generation IV. They also considered a number of plant designs that had good potential for deployment in the near term, and selected 16 such designs for recognition as International Near-Term Deployment (INTD). Both lists are presented in the next chapter.

The following figure presents the four goal areas, with the eight goals arranged under them, and the 15 criteria and their 24 metrics assigned to the various goals. The criteria and metrics are grouped to indicate which goals they were assigned to. For example, under the sustainability goal area there are two goals. The first goal, "SU1 Resource Utilization," is evaluated using a single focused criterion named, "SU1-1 Fuel Utilization." The second goal, "SU2 Waste Minimization and Management" is evaluated using two criteria. It is very important to note that the criteria are only a sampling of many factors that could have been evaluated—they were not selected to be exhaustive but for their ability to discriminate between concepts on important attributes.

For each criterion, the TWGs evaluated each concept and specified a probability distribution for its performance potential to reflect both the expected performance and performance uncertainty. The Crosscut Groups and the Roadmap Integration Team reviewed these evaluations and recommended changes to make them consistent. For a goal evaluated with several criteria, the goal evaluation was combined using criteria weights suggested by the Evaluation Methodology Group. Comparisons of Generation IV candidates were mostly done at the goal level.

A central feature of the roadmap is that the eight goals of Generation IV are all equally important. That is, a promising concept should ideally advance each, and not create a weakness in one goal to gain strength in another. On the other hand, promising concepts will usually advance one or more of the goals or goal areas more than others. This will be apparent in the six systems recommended below for Generation IV. It should be emphasized that while these numerical evaluation results were a primary input to system selection, additional factors and judgment were also considered in the selection process, as described below.

Roll Up of Metrics, Criteria, Goals and Goal Areas

4 Goal Areas	8 Goals	15 Criteria	24 Metrics	
Sustainability	SU1 Resource Utilization	SU1-1 Fuel Utilization	• Use of fuel resources	
	SU2 Waste Minimization and Management	SU2-1 Waste minimization	• Waste mass • Volume • Heat load • Radiotoxicity	
SU2-2 Environmental impact of waste management and disposal		• Environmental impact		
Economics	EC1 Life Cycle Cost	EC1-1 Overnight construction costs	• Overnight construction costs	
		EC1-2 Production costs	• Production costs	
	EC2 Risk to Capital	EC2-1 Construction duration	• Construction duration	
		EC2-1 Construction duration	• Construction duration	
Safety and Reliability	SR1 Operational Safety and Reliability	SR1-1 Reliability	• Forced outage rate	
		SR1-2 Worker/public - routine exposure	• Routine exposures	
		SR1-3 Worker/public - accident exposure	• Accident exposures	
	SR2 Core Damage	SR2-1 Robust safety features	• Reliable reactivity control • Reliable decay heat removal	
		SR2-2 Well-characterized models	• Dominant phenomena - uncertainty • Long fuel thermal response time • Integral experiments scalability	
	SR3 Offsite Emergency Response	SR3-1 Well-characterized source term/energy	• Source term • Mechanisms for energy release	
		SR3-2 Robust mitigation features	• Long system time constants • Long and effective holdup	
	Proliferation Resistance and Physical Protection	PR1 Proliferation Resistance and Physical Protection	PR1-1 Susceptibility to diversion or undeclared production	• Separated materials • Spent fuel characteristics
			PR1-2 Vulnerability of installations	• Passive safety features

Near the end of the first step, the GIF met to conduct the second step of the selection process in February 2002. Leaders from the NERAC Subcommittee participated in the meeting. The GIF reviewed the preliminary evaluation results and discussed additional considerations that would be important to their final decision. These

included a review of the important conclusions of the fuel cycle studies, which helped to suggest the various missions for Generation IV systems that were of interest: electricity and hydrogen production and actinide^c management. These missions are outlined in a section below.

^cThe term *actinide* refers to the heaviest elements found in used reactor fuel, many of which have long half-lives, including isotopes of uranium, plutonium, neptunium, americium and curium.

A final review of evaluations and performance to missions by the GIF Experts Group completed the third step in April 2002. The GIF met in May and July 2002 to conduct the fourth step. In brief, the candidate concepts that emerged from the final screening were discussed. Each was introduced with a presentation of the concept in terms of final evaluations, performance of missions, and estimated deployment dates and R&D costs. The Policy members discussed the concepts until a consensus was reached on six systems found to be the most promising and worthy of collaborative development.

Generation IV Nuclear Energy Systems

The Generation IV roadmap process described in the previous section culminated in the selection of six Generation IV systems. The motivation for the selection of six systems is to

- Identify systems that make significant advances toward the technology goals
- Ensure that the important missions of electricity generation, hydrogen and process heat production, and actinide management may be adequately addressed by Generation IV systems
- Provide some overlapping coverage of capabilities, because not all of the systems may ultimately be viable or attain their performance objectives and attract commercial deployment
- Accommodate the range of national priorities and interests of the GIF countries.

The following six systems, listed alphabetically, were selected to Generation IV by the GIF:

Generation IV System	Acronym
Gas-Cooled Fast Reactor System	GFR
Lead-Cooled Fast Reactor System	LFR
Molten Salt Reactor System	MSR
Sodium-Cooled Fast Reactor System	SFR
Supercritical-Water-Cooled Reactor System	SCWR
Very-High-Temperature Reactor System	VHTR

The six Generation IV systems are summarized in the next section after a short introduction of the FCCG findings. The INTD systems are described later in the report. In addition to overall summaries regarding fuel cycles and overall sustainability, the section describes missions and economic outlook, approach to safety and reliability, and path forward on proliferation resistance and physical protection.

FINDINGS OF THE ROADMAP

Fuel Cycles and Sustainability

The studies of the Fuel Cycle Crosscut Group are central to the development of systems that encompass complete fuel cycles. They defined four general classes of nuclear fuel cycle, ranging through (1) the once-through fuel cycle, (2) a fuel cycle with partial recycle of plutonium, (3) a fuel cycle with full plutonium recycle, and (4) a fuel cycle with full recycle of transuranic elements. These four general classes were modeled over the next century based on projections of the demand for nuclear energy developed by the World Energy Council and the International Institute for Applied Systems Analysis. The majority of the analyses were based on a projection that nuclear energy would only maintain its current market share of electricity, although a number of alternative projections that included the expansion or decline of nuclear energy's role were considered to explore the sensitivity of the conclusions.

nuclear energy with the once-through cycle is the availability of repository space worldwide [see left figure]. This becomes an important issue, requiring new repository development in only a few decades (e.g., a typical repository is of the order of 100 000 tonne capacity). In the longer term, beyond 50 years, uranium resource availability also becomes a limiting factor [see right figure] unless breakthroughs occur in mining or extraction technologies.

Systems that employ a fully closed fuel cycle hold the promise to reduce repository space and performance requirements, although their costs must be held to acceptable levels. Closed fuel cycles permit partitioning the nuclear waste and management of each fraction with the best strategy. Advanced waste management strategies include the transmutation of selected nuclides, cost-effective decay-heat management, flexible interim storage, and customized waste forms for specific geo-

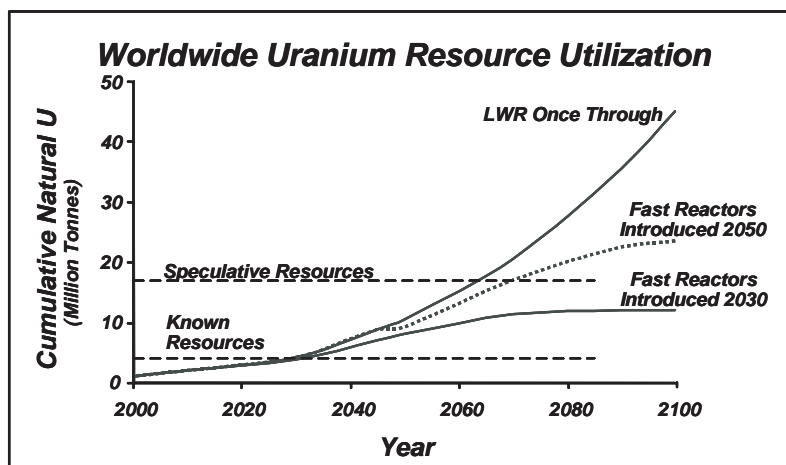
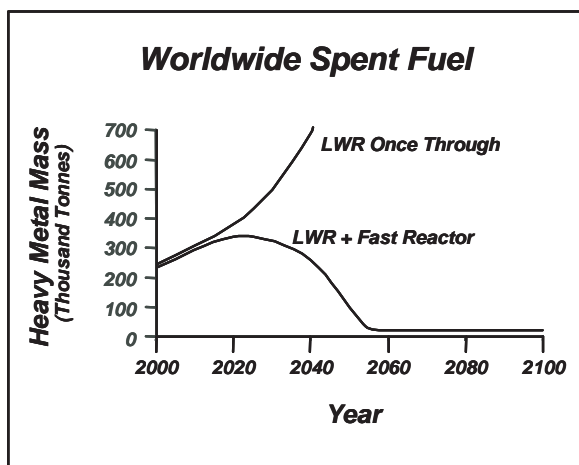

As a reference case, the FCCG determined waste generation and resource use for the once-through cycle. While this fuel cycle option is the most uranium resource-intensive and generates the most waste in the form of used nuclear fuel, the amounts of waste produced are small compared to other energy technologies. In addition, the existing known and speculative economic uranium resources are sufficient to support a once-through cycle at least until mid-century. They found that the limiting factor facing an essential role for

logic repository environments. These strategies hold the promise to reduce the long-lived radiotoxicity of waste destined for geological repositories by at least an order of magnitude. This is accomplished by recovering most of the heavy long-lived radioactive elements. These reductions and the ability to optimally condition the residual wastes and manage their heat loads permit far more efficient use of limited repository capacity and enhances the overall safety of the final disposal of radioactive wastes.

Because closed fuel cycles require the partitioning of spent fuel, they have been perceived as increasing the risk of nuclear proliferation. The advanced separations technologies for Generation IV systems are designed to avoid the separation of plutonium and incorporate other features to enhance proliferation resistance and incorporate effective safeguards. In particular, to help meet the Generation IV goal for increased proliferation resistance and physical protection, all Generation IV systems employing recycle avoid separation of plutonium from other actinides and incorporate additional features to reduce the accessibility and weapons attractiveness of materials at every stage of the fuel cycle.

In the most advanced fuel cycles using fast-spectrum reactors and extensive recycling, it may be possible to reduce the radiotoxicity of all wastes such that the isolation requirements can be reduced by several orders of magnitude (e.g., for a time as low as 1000 years) after

discharge from the reactor. This would have a beneficial impact on the design of future repositories and disposal facilities worldwide. However, this scenario can only be established through considerable R&D on recycling technology. This is a motivating factor in the roadmap for the emphasis on crosscutting fuel cycle R&D.

The studies also established an understanding of the ability of various reactors to be combined in so-called symbiotic fuel cycles. For example, combinations of thermal reactors and fast reactors are found to work well together. As shown in the figure to the left, they feature the recycle of actinides from the thermal systems into the fast systems, and exhibit the ability to reduce actinide inventories worldwide. Improvements in the burnup capability of gas- or water-cooled thermal reactors may also contribute to actinide management in a symbiotic system. Thermal systems also have the flexibility to develop features, such as hydrogen production in high-temperature gas reactors or highly economical light water reactors, which are part of an overall system offering a more sustainable future. This is a motivating factor in the roadmap for having a portfolio of Generation IV systems rather than a single system—realizing that various combinations of a few systems in the portfolio will be able to provide a desirable symbiotic system worldwide.

As a final note, the FCCG observed that nuclear energy is unique in the market since its fuel cycle contributes only about 20% of its production cost. This provides flexibility in separating the approach for meeting the economics and safety goals from the approach for meeting sustainability and safeguards goals. That is, adopting a fuel cycle that is advanced beyond the on- through cycle may be achievable at a reasonable cost.

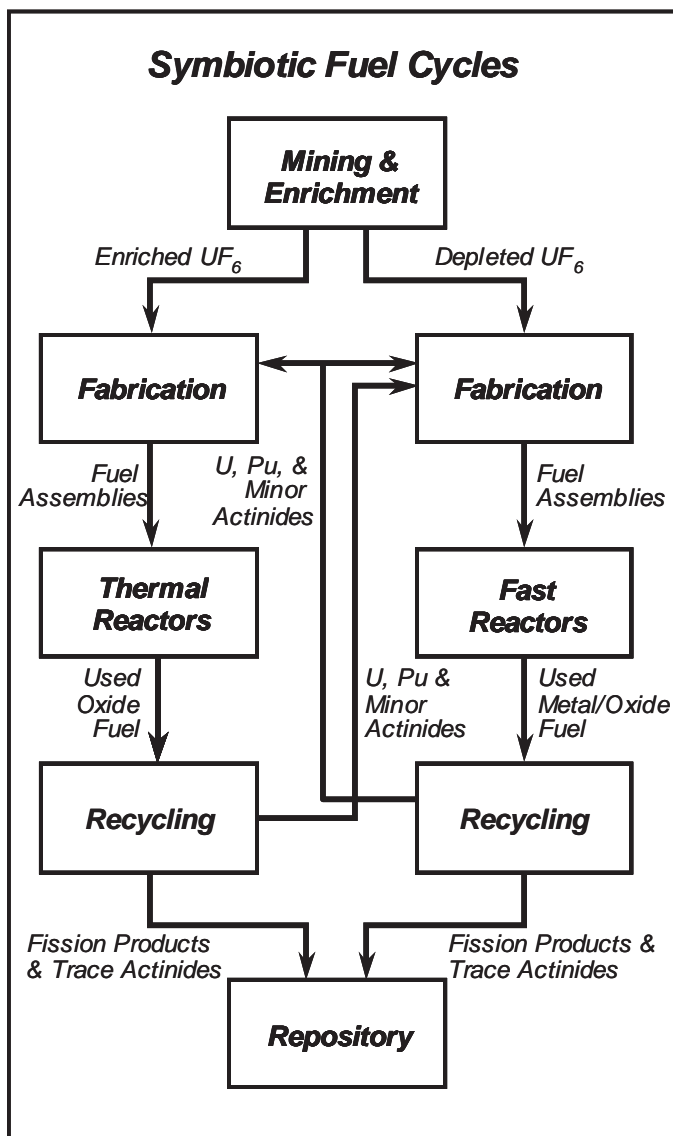

Descriptions of the Generation IV Systems

Each Generation IV system is described briefly, in alphabetical order, below.

GFR – Gas-Cooled Fast Reactor System

The Gas-Cooled Fast Reactor (GFR) system features a fast-neutron spectrum and closed fuel cycle for efficient conversion of fertile uranium and management of actinides. A full actinide recycle fuel cycle with on-site fuel cycle facilities is envisioned. The fuel cycle facilities can minimize transportation of nuclear materials and will be based on either advanced aqueous, pyrometallurgical, or other dry processing options. The reference reactor is a 600-MWth/288-MWe, helium-cooled system operating with an outlet temperature of 850°C using a direct Brayton cycle gas turbine for high thermal effi-

ciency. Several fuel forms are being considered for their potential to operate at very high temperatures and to ensure an excellent retention of fission products: composite ceramic fuel, advanced fuel particles, or ceramic clad elements of actinide compounds. Core configurations are being considered based on pin- or plate-based fuel assemblies or prismatic blocks.

The GFR system is top-ranked in sustainability because of its closed fuel cycle and excellent performance in actinide management. It is rated good in safety, economics, and in proliferation resistance and physical protection. It is primarily envisioned for missions in electricity production and actinide management, although it may be able to also support hydrogen production. Given its R&D needs for fuel and recycling technology development, the GFR is estimated to be deployable by 2025.

LFR – Lead-Cooled Fast Reactor System

The Lead-Cooled Fast Reactor (LFR) system features a fast-neutron spectrum and a closed fuel cycle for efficient conversion of fertile uranium and management of actinides. A full actinide recycle fuel cycle with central or regional fuel cycle facilities is envisioned. The system uses a lead or lead/bismuth eutectic liquid-metal-cooled reactor. Options include a range of plant ratings, including a *battery* of 50–150 MWe that features a very long refueling interval, a modular system rated at 300–400 MWe, and a large monolithic plant option at 1200 MWe. The term *battery* refers to the long-life, factory-fabricated core, not to any provision for electrochemical energy conversion. The fuel is metal or nitride-based, containing fertile uranium and transuranics. The most advanced of these is the Pb/Bi battery, which employs a small size core with a very long (10–30 year) core life. The reactor module is designed to be factory-fabricated and then transported to the plant site. The reactor is cooled by natural convection and sized between 120–400 MWth, with a reactor outlet coolant temperature of 550°C, possibly ranging up to 800°C, depending upon the success of the materials R&D. The system is specifically designed for distributed generation of electricity and other energy products, including hydrogen and potable water.

The LFR system is top-ranked in sustainability because a closed fuel cycle is used, and in proliferation resistance and physical protection because it employs a long-life core. It is rated good in safety and economics. The safety is enhanced by the choice of a relatively inert coolant. It is primarily envisioned for missions in electricity and hydrogen production and actinide man-

agement with good proliferation resistance. Given its R&D needs for fuel, materials, and corrosion control, the LFR system is estimated to be deployable by 2025.

MSR – Molten Salt Reactor System

The Molten Salt Reactor (MSR) system features an epithermal to thermal neutron spectrum and a closed fuel cycle tailored to the efficient utilization of plutonium and minor actinides. A full actinide recycle fuel cycle is envisioned. In the MSR system, the fuel is a circulating liquid mixture of sodium, zirconium, and uranium fluorides. The molten salt fuel flows through graphite core channels, producing a thermal spectrum. The heat generated in the molten salt is transferred to a secondary coolant system through an intermediate heat exchanger, and then through another heat exchanger to the power conversion system. Actinides and most fission products form fluorides in the liquid coolant. The homogenous liquid fuel allows addition of actinide feeds with variable composition by varying the rate of feed addition. There is no need for fuel fabrication. The reference plant has a power level of 1000 MWe. The system operates at low pressure (<0.5 MPa) and has a coolant outlet temperature above 700°C, affording improved thermal efficiency.

The MSR system is top-ranked in sustainability because of its closed fuel cycle and excellent performance in waste burndown. It is rated good in safety, and in proliferation resistance and physical protection, and it is rated neutral in economics because of its large number of subsystems. It is primarily envisioned for missions in electricity production and waste burndown. Given its R&D needs for system development, the MSR is estimated to be deployable by 2025.

SFR – Sodium-Cooled Fast Reactor System

The Sodium-Cooled Fast Reactor (SFR) system features a fast-neutron spectrum and a closed fuel cycle for efficient conversion of fertile uranium and management of actinides. A full actinide recycle fuel cycle is envisioned with two major options: One is an intermediate size (150 to 500 MWe) sodium-cooled reactor with a uranium-plutonium-minor-actinide-zirconium metal alloy fuel, supported by a fuel cycle based on pyrometallurgical processing in collocated facilities. The second is a medium to large (500 to 1500 MWe) sodium-cooled fast reactor with mixed uranium-plutonium oxide fuel, supported by a fuel cycle based upon advanced aqueous processing at a central location serving a number of reactors. The outlet temperature is approximately 550°C for both. The primary focus of the R&D is on the

recycle technology, economics of the overall system, assurance of passive safety, and accommodation of bounding events.

The SFR system is top-ranked in sustainability because of its closed fuel cycle and excellent potential for actinide management, including resource extension. It is rated good in safety, economics, and proliferation resistance and physical protection. It is primarily envisioned for missions in electricity production and actinide management. The SFR system is the nearest-term actinide management system. Based on the experience with oxide fuel, this option is estimated to be deployable by 2015.

SCWR – Supercritical-Water-Cooled Reactor System

The Supercritical-Water-Cooled Reactor (SCWR) system features two fuel cycle options: the first is an open cycle with a thermal neutron spectrum reactor; the second is a closed cycle with a fast-neutron spectrum reactor and full actinide recycle. Both options use a high-temperature, high-pressure, water-cooled reactor that operates above the thermodynamic critical point of water (22.1 MPa, 374°C) to achieve a thermal efficiency approaching 44%. The fuel cycle for the thermal option is a once-through uranium cycle. The fast-spectrum option uses central fuel cycle facilities based on advanced aqueous processing for actinide recycle. The fast-spectrum option depends upon the materials' R&D success to support a fast-spectrum reactor.

In either option, the reference plant has a 1700-MWe power level, an operating pressure of 25 MPa, and a reactor outlet temperature of 550°C. Passive safety features similar to those of the simplified boiling water reactor are incorporated. Owing to the low density of supercritical water, additional moderator is added to thermalize the core in the thermal option. Note that the balance-of-plant is considerably simplified because the coolant does not change phase in the reactor.

The SCWR system is highly ranked in economics because of the high thermal efficiency and plant simplification. If the fast-spectrum option can be developed, the SCWR system will also be highly ranked in sustainability. The SCWR is rated good in safety, and in proliferation resistance and physical protection. The SCWR system is primarily envisioned for missions in electricity production, with an option for actinide management. Given its R&D needs in materials compatibility, the SCWR system is estimated to be deployable by 2025.

VHTR – Very-High-Temperature Reactor System

The Very-High-Temperature Reactor (VHTR) system uses a thermal neutron spectrum and a once-through uranium cycle. The VHTR system is primarily aimed at relatively faster deployment of a system for high-temperature process heat applications, such as coal gasification and thermochemical hydrogen production, with superior efficiency.

The reference reactor concept has a 600-MWth helium-cooled core based on either the prismatic block fuel of the Gas Turbine–Modular Helium Reactor (GT-MHR) or the pebble fuel of the Pebble Bed Modular Reactor (PBMR). The primary circuit is connected to a steam reformer/steam generator to deliver process heat. The VHTR system has coolant outlet temperatures above 1000°C. It is intended to be a high-efficiency system that can supply process heat to a broad spectrum of high-temperature and energy-intensive, nonelectric processes. The system may incorporate electricity generation equipment to meet cogeneration needs. The system also has the flexibility to adopt U/Pu fuel cycles and offer enhanced waste minimization. The VHTR requires significant advances in fuel performance and high-temperature materials, but could benefit from many of the developments proposed for earlier prismatic or pebble bed gas-cooled reactors. Additional technology R&D for the VHTR includes high-temperature alloys, fiber-reinforced ceramics or composite materials, and zirconium-carbide fuel coatings.

The VHTR system is highly ranked in economics because of its high hydrogen production efficiency, and in safety and reliability because of the inherent safety features of the fuel and reactor. It is rated good in proliferation resistance and physical protection, and neutral in sustainability because of its open fuel cycle. It is primarily envisioned for missions in hydrogen production and other process-heat applications, although it could produce electricity as well. The VHTR system is the nearest-term hydrogen production system, estimated to be deployable by 2020.

Missions and Economics for Generation IV

While the evaluations of systems for their potential to meet all goals were a central focus of the roadmap participants, it was recognized that countries would have various perspectives on their priority uses, or missions, for Generation IV systems. The following summary of missions resulted from a number of discussions by the GIF and the roadmap participants. The summary defines

three major mission interests for Generation IV: electricity, hydrogen (or other nonelectricity products), and actinide management. The table below indicates the mission focus of each of the six Generation IV systems with regard to electricity and hydrogen.

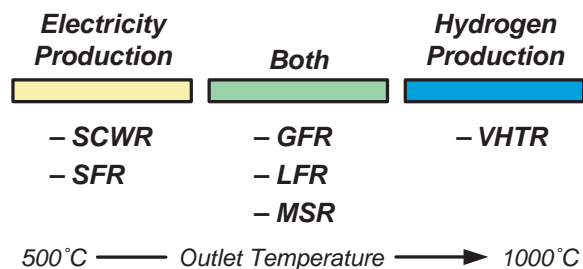

Electricity Generation

The traditional mission for civilian nuclear systems has been generation of electricity, and several evolutionary systems with improved economics and safety are likely in the near future to continue fulfilling this mission. It is expected that Generation IV systems designed for the electricity mission will yield innovative improvements in economics and be very cost-competitive in a number of market environments, while seeking further advances in safety, proliferation resistance, and physical protection. These Generation IV systems may operate with either an open or closed fuel cycle that reduces high-level waste volume and mass. Further, it may be beneficial to deploy these nearer- and longer-term systems symbiotically to optimize the economics and sustainability of the ensemble. Within the electricity mission, two specializations are needed:

Large Grids, Mature Infrastructure, Deregulated Market. These Generation IV systems are designed to compete effectively with other means of electricity production in market environments with larger, stable distribution grids; well-developed and experienced nuclear supply, service, and regulatory entities; and a variety of market conditions, including highly competitive deregulated or reformed markets.

Small Grids, Limited Nuclear Infrastructure. These Generation IV systems are designed to be attractive in electricity market environments characterized by small, sometimes isolated, grids and a limited nuclear regulatory and supply/service infrastructure. These environments might lack the capability to manufacture their own fuel or to provide more than temporary storage of used fuel.

Hydrogen Production, Cogeneration, and other Nonelectricity Missions

This emerging mission requires nuclear systems that are designed to deliver other energy products based on the fission heat source, or which may deliver a combination of process heat and electricity. Either may serve large grids, or small isolated grids, or stand alone. The process heat is delivered at sufficiently high temperatures (likely needed to be greater than 700°C) to support steam-reforming or thermochemical production of hydrogen, as well as other chemical production processes. These applications can use the high temperature heat or the lower temperature heat rejected from the system. Application to desalination for potable water production may be an important use for the rejected heat.

In the case of cogeneration systems, the reactor provides all thermal and electrical needs of the production park. The distinguishing characteristic for this mission is the high temperature at which the heat is delivered. Besides being economically competitive, the systems designed for this mission would need to satisfy stringent standards of safety, proliferation resistance, physical protection, and product quality.

For this mission, systems may again be designed to employ either an open or closed fuel cycle, and they may ultimately be symbiotically deployed to optimize economics and sustainability.

Actinide Management

Actinide management is a mission with significant societal benefits—nuclear waste consumption and long-term assurance of fuel availability. This mission overlaps an area that is typically a national responsibility, namely the disposition of spent nuclear fuel and high-level waste. Although Generation IV systems for actinide management aim to generate electricity economically, the market environment for these systems is not yet well defined, and their required economic performance in the near term will likely be determined by the governments that deploy them. The table below indicates that most Generation IV systems are aimed at actinide management, with the exception of the VHTR.

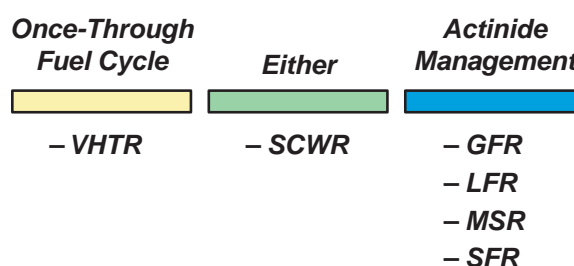

Note that the SCWR begins with a thermal neutron spectrum and once-through fuel cycle, but may ultimately be able to achieve a fast spectrum with recycle.

The mid-term (30–50 year) actinide management mission consists primarily of limiting or reversing the buildup of the inventory of spent nuclear fuel from current and near-term nuclear plants. By extracting actinides from spent fuel for irradiation and multiple recycle in a closed fuel cycle, heavy long-lived radiotoxic constituents in the spent fuel are transmuted into much shorter-lived or stable nuclides. Also, the intermediate-lived actinides that dominate repository heat management are transmuted.

In the longer term, the actinide management mission can beneficially produce excess fissionable material for use in systems optimized for other energy missions. Because of their ability to use recycled fuel and generate needed fissile materials, systems fulfilling this mission could be very naturally deployed in symbiosis with systems for other missions. With closed fuel cycles, a large expansion of global uranium enrichment is avoided.

Observations on Economics

The work of the Economics Crosscut Group is central to understanding the limitations and opportunities regarding economics in the roadmap. These are discussed in turn.

Many limitations to the evaluation of economics are apparent. Examples are the large uncertainty when projecting production and capital costs several decades into the future, the uncertainty stemming from the outcome of R&D on innovative advances for a system, and even the inability to validate the detailed analyses provided by advocates with a potential bias. As a result, the economics evaluations are very uncertain. They strive to indicate a general impression of the future potential, having weighed a large amount of information. Of course, all Generation IV systems will need to meet the economic requirements of the investors. Because of this, researchers and designers will need to continually address system economics as the R&D proceeds. The economic evaluations in the roadmap should be taken as a relative indicator of how much emphasis needs to be placed on the improvement of economics through continued R&D.

A major opportunity debated among the systems was between the long-established industry trend of larger, monolithic plants that exploit economy of scale, versus the possibility that smaller, modular plants may be able

to use factory fabrication to exploit economy of volume. The six Generation IV systems feature a range of sizes, as shown in the table below. While the Economics Crosscut Group evaluations could not resolve the debate, it underscored the need for crosscutting R&D into the issue of modular plant versus monolithic plant economics and the market/financial conditions under which these different types of plants would be preferred.

Large Monolithic	Mid-size	Small Modular
– LFR*	– GFR	– LFR*
– MSR	– VHTR	
– SFR*	– SFR*	
– SCWR		

* Range of options

Safety, Safeguards, and Public Confidence in Generation IV

Of all the goal areas, those regarding safety of nuclear energy systems, protection of nuclear materials and facilities within the system against acts of terrorism, and nuclear proliferation are most closely linked to public confidence in nuclear energy. The roadmap evaluations of the safety and reliability goals indicated that the selected systems offer significant potential for advances. Most employ passive and active design features to help avoid accidents in the first place, reduce reliance on operator action, and mitigate the consequences of potential accidents.

While various means to enhance proliferation resistance and physical protection are implemented in the systems, a standard methodology for their evaluation is not yet developed. A major recommendation of the roadmap is that R&D in this goal area should be focused on developing a more comprehensive evaluation methodology. This will allow Generation IV systems to optimize their use of intrinsic barriers and extrinsic safeguards in the course of their development. Public confidence will increase with enhanced proliferation resistance and physical protection.

Near-Term Deployment Opportunities and Generation IV

While the Generation IV roadmap defined the long-term objectives and needed R&D on innovative systems, efforts have been underway to define actions for nearer-

term deployment of evolutionary nuclear plants. To better appreciate the relationship, the technology roadmap identified a number of nearer-term systems that could have a benefit to the development of Generation IV systems. These activities are described in turn.

United States Near-Term Deployment

In the United States, the DOE's independent Nuclear Energy Research Advisory Committee conducted a study to identify the actions needed by government and industry to overcome the technical and regulatory barriers to new plant construction by 2010. The results of this study were documented in the October 2001 report titled, *A Roadmap to Deploy New Nuclear Power Plants in the United States by 2010*. Eight candidate reactor designs were evaluated with respect to six commercialization and regulatory readiness criteria, including advanced boiling water reactors, pressurized water reactors, and gas-cooled reactors. Six designs were found to be at least possibly deployable by 2010, provided that generating companies commit to placing new plant orders by 2003. The list of U.S. Near-Term Deployment (NTD) options are shown in the table with acronyms or trade names below:

- ABWR (Advanced Boiling Water Reactor)
- AP1000 (Advanced Pressurized Water Reactor 1000)
- ESBWR (European Simplified Boiling Water Reactor)
- GT-MHR (Gas Turbine–Modular High Temperature Reactor)
- PBMR (Pebble Bed Modular Reactor)
- SWR-1000 (Siedewasser Reactor-1000).

The recommendations for action involved industry/government collaboration and cost-sharing on generic and plant-specific initiatives in the areas of (1) exercising the new plant regulatory approval process in the United States, and (2) completing detailed engineering and design work for at least one advanced reactor design in each of the water and gas reactor tracks. To accomplish these tasks, DOE announced in February 2002 its Nuclear Power 2010 initiative, which focuses on deployment of new plants in the United States over the next ten years.

U.S. Near-Term Deployment (by 2010)
ABWR AP1000 ESBWR GT-MHR PBMR SWR-1000

International Near-Term Deployment

The Generation IV roadmap effort also identified other designs that could be deployed in the nearer term. The GIF expressed a strong interest in recognizing these reactor designs as having this potential. Accordingly, the GIF created a distinct group known as International Near-Term Deployment (INTD), and adopted two criteria for systems to be included. First, recognizing the difficulty of deployment by 2010, the GIF decided to use a somewhat later international deployment date of 2015 for designs having significant industrial sponsorship. Second, the GIF decided to include only those systems whose performance is equal to or better than a light water reactor performance baseline representative of Generation III. The baseline included performance measures in the four goal areas. While not described in detail here, they generally represent the Advanced Light Water Reactors (ALWRs) that have been built recently. Beginning with the May 2002 meeting, and working up to the July 2002 meeting, the GIF finalized a list of systems to be recognized as INTD designs.

Sixteen designs were found to be probably deployable by 2015 or earlier, and to be equal to or better than the ALWR performance baseline. These are shown in the table below with acronyms or trade names:

Advanced Boiling Water Reactors

- ABWR II (Advanced Boiling Water Reactor II)
- ESBWR (European Simplified Boiling Water Reactor)
- HC-BWR (High Conversion Boiling Water Reactor)
- SWR-1000 (Siedewasser Reactor-1000)

Advanced Pressure Tube Reactor

- ACR-700 (Advanced CANDU Reactor 700)

Advanced Pressurized Water Reactors

- AP600 (Advanced Pressurized Water Reactor 600)
- AP1000 (Advanced Pressurized Water Reactor 1000)
- APR1400 (Advanced Power Reactor 1400)

International Near-Term Deployment (by 2015)
ABWR II ACR-700 AP600 AP1000 APR1400 APWR+ CAREM EPR ESBWR GT-MHR HC-BWR IMR IRIS PBMR SMART SWR-1000

- APWR+ (Advanced Pressurized Water Reactor Plus)
- EPR (European Pressurized Water Reactor)

Integral Primary System Reactors

- CAREM (Central Argentina de Elementos Modulares)
- IMR (International Modular Reactor)
- IRIS (International Reactor Innovative and Secure)
- SMART (System-Integrated Modular Advanced Reactor)

Modular High Temperature Gas-Cooled Reactors

- GT-MHR (Gas Turbine-Modular High Temperature Reactor)
- PBMR (Pebble Bed Modular Reactor)

Most INTD candidates have R&D needs to address on the way toward possible deployment. Where the Generation IV roadmap identifies the R&D needs for the selected Generation IV systems, some of the near-term candidates have similar R&D needs in these areas.

Therefore, it is important to recognize that the advancement of some candidates could make a beneficial contribution to the technology development

Generation IV Deployment

The objective for Generation IV nuclear energy systems is to have them available for wide-scale deployment before the year 2030. The best-case deployment dates anticipated for the six Generation IV systems are shown in the table to the right, and the dates extend further out than those for near-term deployment. These dates assume that considerable resources are applied to their R&D. The specific R&D activities are defined in recom-

mended R&D sections of this roadmap. The integration and support of those activities is developed in more detail in the Integration and Path Forward section at the end of this roadmap.

The Generation IV R&D activities are based on the assumption that not all near-term deployable systems will be pursued by the private sector, but recognizes that relevant R&D on the near-term systems may have a direct benefit to the Generation IV program. That is, each one of the six systems has an R&D plan that is complete, but the R&D to be undertaken in Generation IV may be reduced by technology development of a relevant INTD system that is deployed.

The Generation IV program will continually monitor industry- and industry/government-sponsored R&D plans and progress in order to benefit from them and not create duplicate efforts. Cases where industrial developments are halted or merged may signal needed changes in the Generation IV R&D plans. Likewise, early Generation IV R&D may hold significant advances for near-term systems.

<i>Generation IV System</i>	<i>Best Case Deployment Date</i>
SFR	2015
VHTR	2020
GFR	2025
MSR	2025
SCWR	2025
LFR	2025

RECOMMENDED R&D FOR THE MOST PROMISING SYSTEMS

Introduction

This section presents a survey of the recommended *system-specific* R&D for the six Generation IV systems. If the research potentially applies to more than one system, it is presented in the next major section as *crosscutting*.

The progression of R&D activities is divided into phases. The first is the *viability* phase, where the principal objective is to resolve key feasibility and proof-of-principle issues. The emphasis on the viability of the system is intended to yield answers before undertaking large-scale technology development. Early interactions with regulators identifies high-level safety requirements. Decisions to proceed with the R&D focus on the feasibility of key technologies. The second phase is the *performance* phase, where the key subsystems (such as the reactor, recycling facilities or energy conversion technology) need to be developed and optimized. Continuing interactions with regulators advances the level of understanding of the safety approach. Decisions to proceed with the R&D now focus on the ability to make progress toward the desired performance levels. This phase ends when the system is sufficiently mature and performs well enough to attract industrial interest in large-scale demonstration of the technology.

The third phase is the *demonstration* phase, which has a number of options as to the nature of the scope, size, and length of time such a demonstration will have, as well as the nature of the participation of industry, government, and even other countries in the project. Owing to the new and innovative technology, it is felt that any Generation IV system will need a demonstration phase. This is generally expected to require at least six years, possibly more, and funding of several billion U.S. dollars. With successful demonstration, a system may enter a *commercialization* phase, which is an industry action.

The R&D presented in this section is limited to the viability and performance phases. Some recommendations are also included regarding the type of project that is envisioned to be appropriate for demonstration, although those activities are outside the scope of the technology roadmap.

As Generation IV systems advance, the evaluation methodology will need to develop into broader and more comprehensive tools for the assessment of the systems. Crosscutting R&D for evaluation methods is found in the Crosscutting R&D sections on fuel cycles, risk and safety, economics, and proliferation resistance and physical protection. Of particular importance to all areas is developing the capability to quantify the uncertainty in the evaluations.

Schedules for the recommended R&D and associated cost estimates are provided at the end of each system-specific R&D and crosscutting R&D sections. The scope, schedule, and cost of R&D activities described in the roadmap are conceptual and intended to address the most important of known viability and performance issues that have been identified by the international working groups. The costs have been estimated through expert judgment and comparison, and not through rigorous program planning. The estimates assume relatively successful and continuing R&D, and do not project the effect of major program redirection from setbacks and failures. Very importantly, they do not include demonstration phase activities. In addition, costs for R&D facilities and infrastructure upgrades, such as the cost of a new materials test reactor, are not included.

Crosscutting R&D must be performed in addition to the system-specific R&D to support development of a system. Thus, the complete cost for a system must include an appropriate share of the crosscutting R&D costs.

The cost estimates provided in the roadmap are primarily for the purpose of comparing the recommended systems. They do not reflect the ongoing programs or future commitments of the GIF member countries.

The schedules are based on scenarios of successful deployment, with ample funding to achieve progress and with a capable nuclear R&D infrastructure. The estimated costs and anticipated schedules for the viability and performance R&D are based on the collective judgment of the working groups. Large uncertainties exist in these costs and schedules. More detailed planning will be required from the organizations performing the R&D.

Gas-Cooled Fast Reactor System R&D

GFR Description

The GFR system features a fast-spectrum helium-cooled reactor [shown below] and closed fuel cycle. Like thermal-spectrum helium-cooled reactors such as the GT-MHR and the PBMR, the high outlet temperature of the helium coolant makes it possible to deliver electricity, hydrogen, or process heat with high conversion efficiency. The GFR uses a direct-cycle helium turbine for electricity and can use process heat for thermochemi-

cal production of hydrogen. Through the combination of a fast-neutron spectrum and full recycle of actinides, GFRs minimize the production of long-lived radioactive waste isotopes. The GFR's fast spectrum also makes it possible to utilize available fissile and fertile materials (including depleted uranium from enrichment plants) two orders of magnitude more efficiently than thermal spectrum gas reactors with once-through fuel cycles. The GFR reference assumes an integrated, on-site spent fuel treatment and refabrication plant.

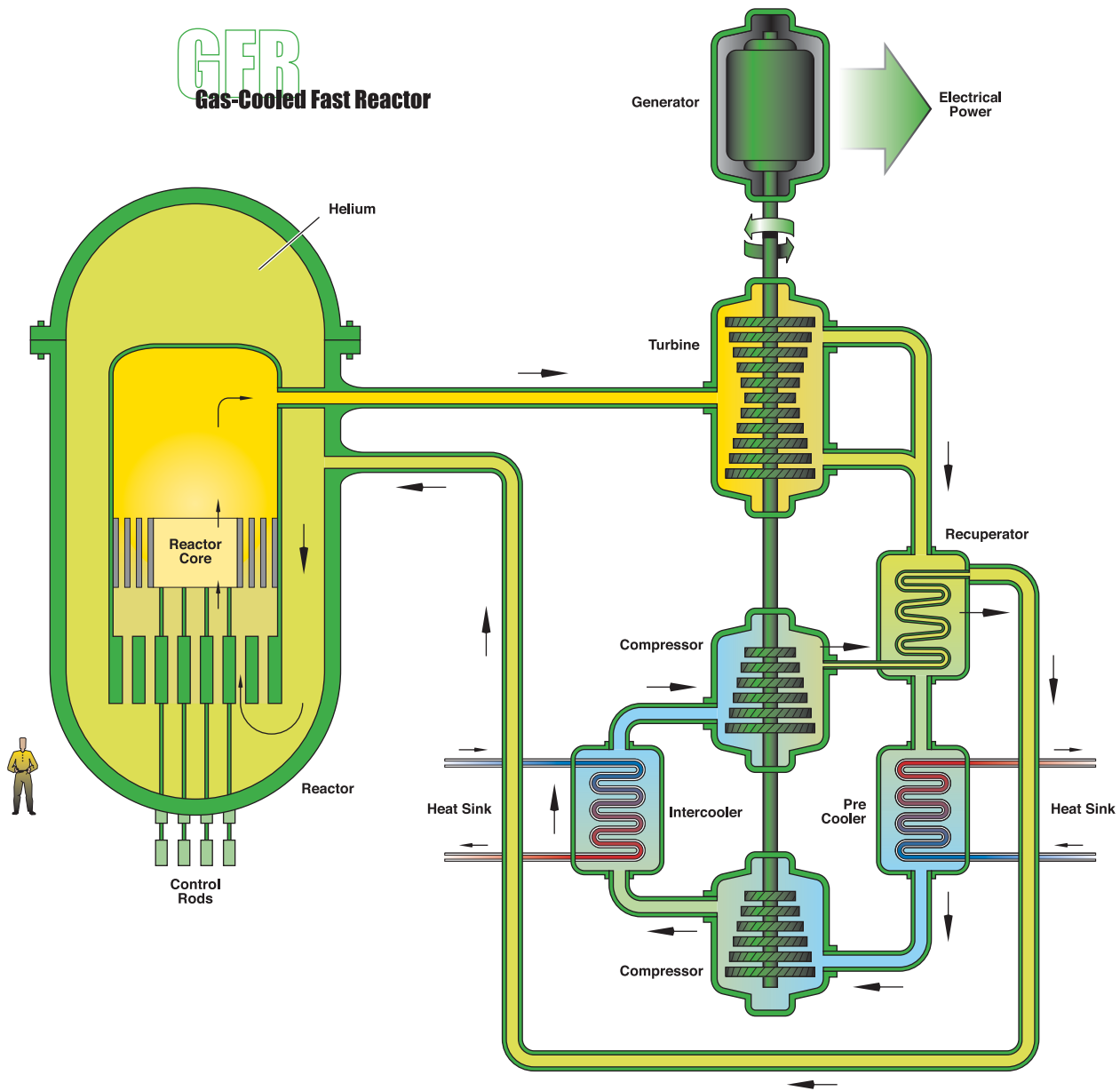

02-GA50807-05

A summary of design parameters for the GFR system is given in the following table.

Reactor Parameters	Reference Value
Reactor power	600 MWth
Net plant efficiency (direct cycle helium)	48%
Coolant inlet/outlet temperature and pressure	490°C/850°C at 90 bar
Average power density	100 MWth/m ³
Reference fuel compound	UPuC/SiC (70/30%) with about 20% Pu content
Volume fraction, Fuel/Gas/SiC	50/40/10%
Conversion ratio	Self-sufficient
Burnup, Damage	5% FIMA; 60 dpa

Technology Base for the GFR

The technology base for the GFR includes a number of thermal spectrum gas reactor plants, as well as a few fast-spectrum gas-cooled reactor designs. Past pilot and demonstration projects include decommissioned reactors such as the Dragon Project, built and operated in the United Kingdom, the AVR and the THTR, built and operated in Germany, and Peach Bottom and Fort St Vrain, built and operated in the United States. Ongoing demonstrations include the HTTR in Japan, which reached full power (30 MWth) using fuel compacts in 1999, and the HTR-10 in China, which may reach 10 MWth in 2002 using pebble fuel. A 300-MWth pebble bed modular demonstration plant is being designed by PBMR Pty for deployment in South Africa, and a consortium of Russian institutes is designing a 300-MWth GT-MHR in cooperation with General Atomics. The design of the PBMR and GT-MHR reactor systems, fuel, and materials are evolutionary advances of the demonstrated technology, except for the direct Brayton-cycle helium turbine and implementation of modularity in the plant design. The GFR may benefit from development of these technologies, as well as development of innovative fuel and very-high-temperature materials for the VHTR. A phased development path may be drawn from the thermal to the fast-spectrum gas-cooled systems.

Technology Gaps for the GFR

Demonstrating the viability of the GFR requires meeting a number of significant technical challenges. Fuel, fuel cycle processes, and safety systems pose the major technology gaps:

- GFR fuel forms for the fast-neutron spectrum
- GFR core design, achieving a fast-neutron spectrum for effective conversion with no fertile blankets
- GFR safety, including decay heat removal systems that address the significantly higher power density (in the range of 100 MWth/m³) and the reduction of the thermal inertia provided by graphite in the modular thermal reactor designs
- GFR fuel cycle technology, including simple and compact spent-fuel treatment and refabrication for recycling.

Performance issues for GFR include:

- Development of materials with superior resistance to fast-neutron fluence under very-high-temperature conditions
- Development of a high-performance helium turbine for efficient generation of electricity
- Development of efficient coupling technologies for process heat applications and the GFR's high temperature nuclear heat.

The GFR has several technology gaps in its primary systems and balance of plant that are in common with the GT-MHR. Also, the development of very-high-temperature materials with superior resistance to fast-neutron fluence and innovative refractory fuel concepts with enhanced fission product retention capability are of generic interest to other types of reactors, including the VHTR and water-cooled reactors.

Target values of some key parameters such as power density and fuel burnup are sufficient for reasonable performance of a first-generation new fuel technology. Because these parameters have a direct impact on technical and economical performance, there is strong incentive for additional performance phase R&D, with the goal of further upgrading the power density to beyond 100 MWth/m³ and the fuel burnup to the range of 15% FIMA.

GFR R&D Scope

An R&D program is recommended to assess the viability of the GFR and conduct the performance R&D required for successful demonstration of the GFR. This development includes R&D on fuel, fuel cycle processes (treatment and refabrication), reactor systems, balance of plant, and computer codes needed for design studies and safety demonstration. A conceptual design of an entire GFR prototype system can be developed by 2019. The prototype system is envisioned as an international project that could be placed in operation by 2025.

GFR Fuels and Materials R&D

Candidate Fuels. A composite ceramic-ceramic fuel (cercer) with closely packed, coated (U, Pu)C kernels or fibers is the best option for fuel development. Alternative fuel options for development include fuel particles with large (U, Pu)C kernels and thin coatings, or ceramic-clad, solid-solution metal (cermet) fuels. The need for a high density of heavy nuclei in the fuel leads to actinide-carbides as the reference fuel and actinide-nitrides with 99.9% enriched nitrogen as the backup.

Initially, the research should focus on studying potential candidate fuels and evaluating their technical feasibility based on existing information on the structural integrity and radiation resiliency of the coating system and the chemical compatibility among the different materials for the GFR service conditions (e.g., temperatures up to 1400°C, burnup up to 250 GWD/MTHM, and radiation resiliency up to 100 to 150 dpa). This will lead to the establishment of reference and backup options. These options will undergo a series of irradiation and high-temperature safety tests in concert with fuel modeling activities to establish the performance of the fuel type. Irradiations range from small-scale experiments in existing reactors to large-scale prototype fuel assemblies under representative GFR conditions. The research is expected to take nearly 20 years to complete.

Key dates are:

- 2002–2004 Acquisition of basic data on inert materials and actinide compounds and definition of reference and backup fuel concepts
- 2005–2011 Irradiation testing in existing reactors
- 2012–2019 Irradiation of prototype fuel subassemblies in GFR representative conditions.

Fuel fabrication techniques must be developed to be compatible with on-site processing for actinide recovery and remote fuel fabrication. Innovative methods such as vapor deposition or impregnation are among the candidate techniques for on-site manufacturing of composite ceramic fuel (cercer, with cermet as backup). For pin-type fuels, ceramic cladding capable of confining fission products will be considered. Samples of irradiated fuels will be used to test current and innovative fuel treatment processes likely to be compatible with remote simple and compact technologies for actinide spent fuel treatment and refabrication before recycling.

Candidate Materials. The main challenges are in-vessel structural materials, both in-core and out-of-core, that will have to withstand fast-neutron damage and high

temperatures, up to 1600°C in accident situations. Ceramic materials are therefore the reference option for in-core materials, and composite cermet structures or inter-metallic compounds will be considered as a backup. For out-of-core structures, metal alloys will be the reference option.

The most promising ceramic materials for core structures are carbides (preferred options are SiC, ZrC, TiC, NbC), nitrides (Zr N, TiN), and oxides (MgO, Zr(Y)O₂). Inter-metallic compounds like Zr₃Si₂ are promising candidates as fast-neutron reflector materials. Limited work on Zr, V or Cr as the metallic part of the backup cermet option should also be undertaken.

For other internal core structures, mainly the upper and lower structures, shielding, the core barrel and grid plate, the gas duct shell, and the hot gas duct, the candidate materials are coated or uncoated ferritic-martensitic steels (or austenitic as alternative solution), other Fe-Ni-Cr-base alloys (Inco 800), and Ni-base alloys. The main candidate materials for pressure vessels (reactor, energy conversion system) and cross vessel are 21/4 Cr and 9-12 Cr martensitic steels.

The recommended R&D activities include a screening phase with material irradiation and characterization, a selection of a reference set of materials for core structural materials, and then optimization and qualification under irradiation.

The program goal is to select the materials that offer the best compromise regarding:

- Fabricability and welding capability
- Physical, neutronic, thermal, tensile, creep, fatigue, and toughness properties and their degradation under low-to-moderate neutron flux and dose
- Microstructure and phase stability under irradiation
- Irradiation creep, in-pile creep, and swelling properties
- Initial and in-pile compatibility with He (and impurities).

Recommended R&D activities on out-of-core structures consists of screening, manufacturing, and characterizing materials for use in the pressure vessel, primary system, and components (pipes, blowers, valves, heat exchangers).

With respect to materials used for the balance of plant, the development program includes screening, manufacturing, and characterizing heat-resisting alloys or composite materials for the Brayton turbomachinery

(turbine disk and fins), as well as for heat exchangers, including the recuperator of the Brayton cycle. Likewise, in the case of nonelectricity energy products, materials development is required for the intermediate heat exchanger that serves to transfer high-temperature heat in the helium coolant to the process heat applications. R&D recommended for these systems is discussed in the Crosscutting Energy Products R&D section.

GFR Reactor Systems R&D

The innovative GFR design features to be developed must overcome shortcomings of past fast-spectrum gas-cooled designs, which were primarily low thermal inertia and poor heat removal capability at low helium pressure. Various passive approaches will be evaluated for the ultimate removal of decay heat in depressurization events. The conditions to ensure a sufficient back pressure and to enhance the reliability of flow initiation are some of the key issues for natural convection, the efficiency of which will have to be evaluated for different fuel types, power densities, and power conversion unit. Dedicated systems, such as semipassive heavy gas injectors, need to be evaluated and developed. There is also a need to study the creation of conduction paths and various methods to increase fuel thermal inertia and, more generally, core capability to store heat while maintaining fuel temperature at an acceptable level.

GFR Balance-of-Plant R&D

Performance R&D is required for the high-temperature helium systems, specifically:

- Purification, control of inventory, and in-service monitoring of interactions between helium and the materials it contacts
- Heat transfer and flow pattern through the core, the circuits, and the heat exchangers
- Dynamics of the circuits and the structures, acoustics of the cavities.

GFR Safety R&D

Because of the high GFR core power density, a safety approach is required that relies on intrinsic core properties supplemented with additional safety devices and systems as needed, but minimizes the need for active systems. After in-depth studies have defined the safety case, safety systems will be demonstrated experimentally. Transient fuel testing, of both the developmental and confirmatory kind, will be conducted. Concurrently, model and code development are required to provide the basis for the final safety case. An integrated safety

experiment, simulating the safety case of the GFR, will be prepared. It is expected that the safety experiments will require an integral helium loop on the order of 20 MWth.

GFR Design and Evaluation R&D

The most important issues regarding economic viability of the GFR are associated with the simplified and integrated fuel cycle, and the modularity of the reactor—this includes volume production, in-factory prefabrication, and sharing of on-site resources.

The GFR design and safety analysis will require development of novel analysis tools capable of modeling the core with its novel fuel and subassembly forms, unusual fuel composition, and novel safety devices. The analysis tools must be validated to demonstrate with sufficient accuracy the safe behavior of the entire system under all operational conditions. This requires new neutronics, thermal-gas dynamics, operation, and safety models, or significant adaptations of existing codes. Validation of the models requires that critical experiments and subassembly mockup testing and possibly other qualification experiments be conducted.

GFR Fuel Cycle R&D

The range of fuel options for the GFR underscores the need for early examination of their impacts on the system, especially its fuel cycle. Existing fuel cycle technologies need to be further developed or adapted to allow for the recycling of actinides while preserving the economic competitiveness of the nuclear option in the medium and long term. Laboratory-scale processes for treatment of carbide, nitride, or oxide dispersion fuels in ceramic or metal matrices have been evaluated and appear technically feasible. However, extensive experimental work is required in order that the process concepts can be proven feasible for fuel treatment at production scale.

Compatibility of Fuel and Fuel Recycling Technology Options. The capabilities of both advanced aqueous and pyrochemical processes for recycling the fuel options under consideration will be assessed, while taking into account the facility requirements associated with on-site fuel conditioning and refabrication. R&D on the two options is discussed in the Crosscutting Fuel Cycle R&D section.

The objective for the GFR fuel cycle R&D is to seek solutions for the separation of its unique materials of the matrices and coatings from actinide compounds that (1) develop the capability to treat cerer fuels, as well as

coated particle fuel or cermet as a backup, (2) minimize the release of gaseous and liquid effluents to the environment, (3) take into account, starting at the design stage, the management of induced secondary waste from treatment and conditioning, (4) simplify the integration of treatment and fuel manufacturing operations, and (5) allow for integrated in situ treatment.

Both aqueous and pyrochemical processing methods, and combinations of the two processes, will be tested on the inert-matrix fuels. Hybrid processes may prove to be superior in the long run. Candidate processes with reasonable expectations of technical feasibility need to be compared in detail at the conceptual stage. The evaluations will be based on mass-balance flow-sheets and estimates of equipment and facility requirements necessary to meet established criteria for product quality and throughput capacity.

Scale Up and Demonstration. An important phase of the R&D program will be to demonstrate, at the level of several kilograms of the selected fuel, the treatment and refabrication of irradiated fuel. The objective is to select and demonstrate the scientific viability of a process by the end of 2012. After process screening, mostly with surrogate materials, more in-depth studies of the selected treatment process will be performed in hot laboratories using irradiated fuel samples provided by the irradiation program for fuel development. The final phase of the development program will consist of demonstrating the technologies associated with the fuel cycle plant of the GFR prototype system.

GFR R&D Schedule and Costs

A schedule for the GFR R&D is shown below, along with the R&D costs and decision points (starred).

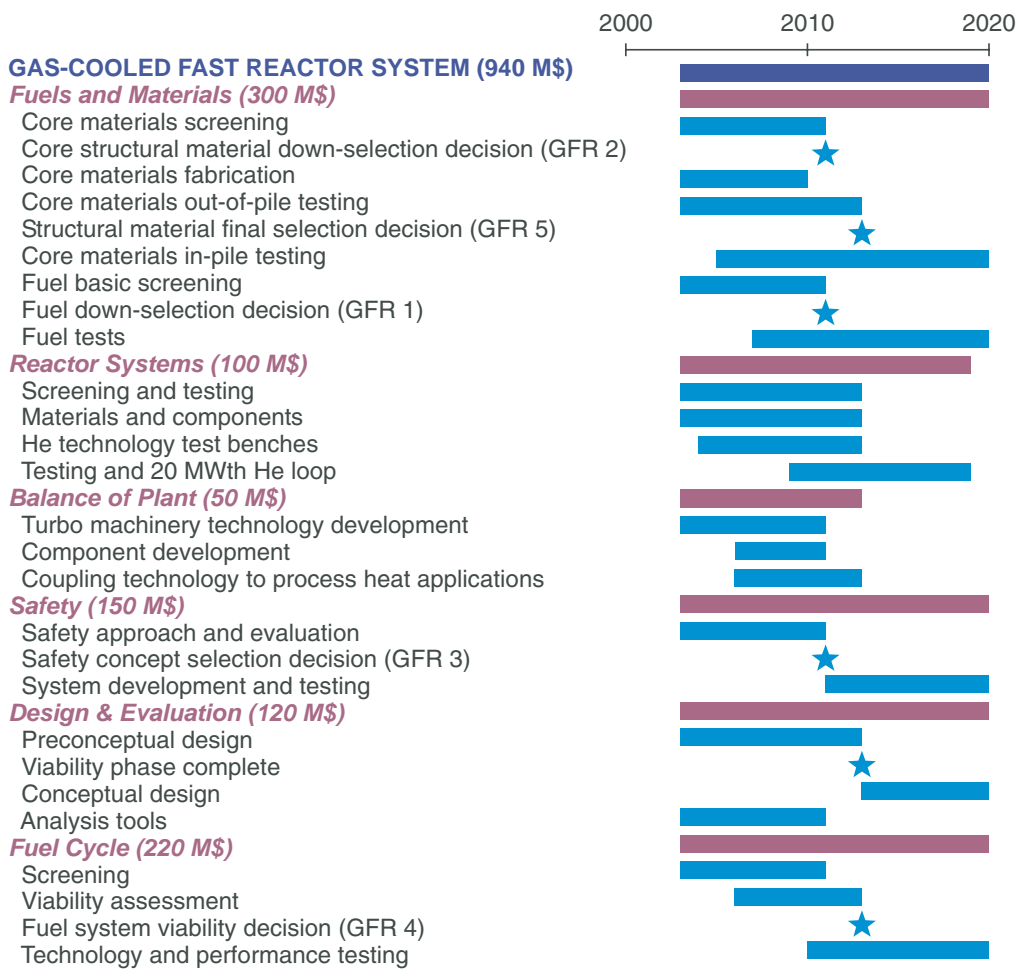

Lead-Cooled Fast Reactor System R&D

LFR Description

LFR systems are Pb or Pb-Bi alloy-cooled reactors with a fast-neutron spectrum and closed fuel cycle. One LFR system is shown below. Options include a range of plant ratings, including a long refueling interval battery ranging from 50–150 MWe, a modular system from 300–400 MWe, and a large monolithic plant at 1200 MWe. These options also provide a range of energy products.

The LFR battery option is a small factory-built turnkey plant operating on a closed fuel cycle with very long refueling interval (15 to 20 years) cassette core or replaceable reactor module. Its features are designed to meet market opportunities for electricity production on small grids, and for developing countries that may not wish to deploy an indigenous fuel cycle infrastructure to support their nuclear energy systems. Its small size,

reduced cost, and full support fuel cycle services can be attractive for these markets. It had the highest evaluations to the Generation IV goals among the LFR options, but also the largest R&D needs and longest development time.

The options in the LFR class may provide a time-phased development path: The nearer-term options focus on electricity production and rely on more easily developed fuel, clad, and coolant combinations and their associated fuel recycle and refabrication technologies. The longer-term option seeks to further exploit the inherently safe properties of Pb and raise the coolant outlet temperature sufficiently high to enter markets for hydrogen and process heat, possibly as merchant plants. LFR holds the potential for advances compared to state-of-the-art liquid metal fast reactors in the following:

- Innovations in heat transport and energy conversion are a central feature of the LFR options. Innovations in heat transport are afforded by natural circulation,

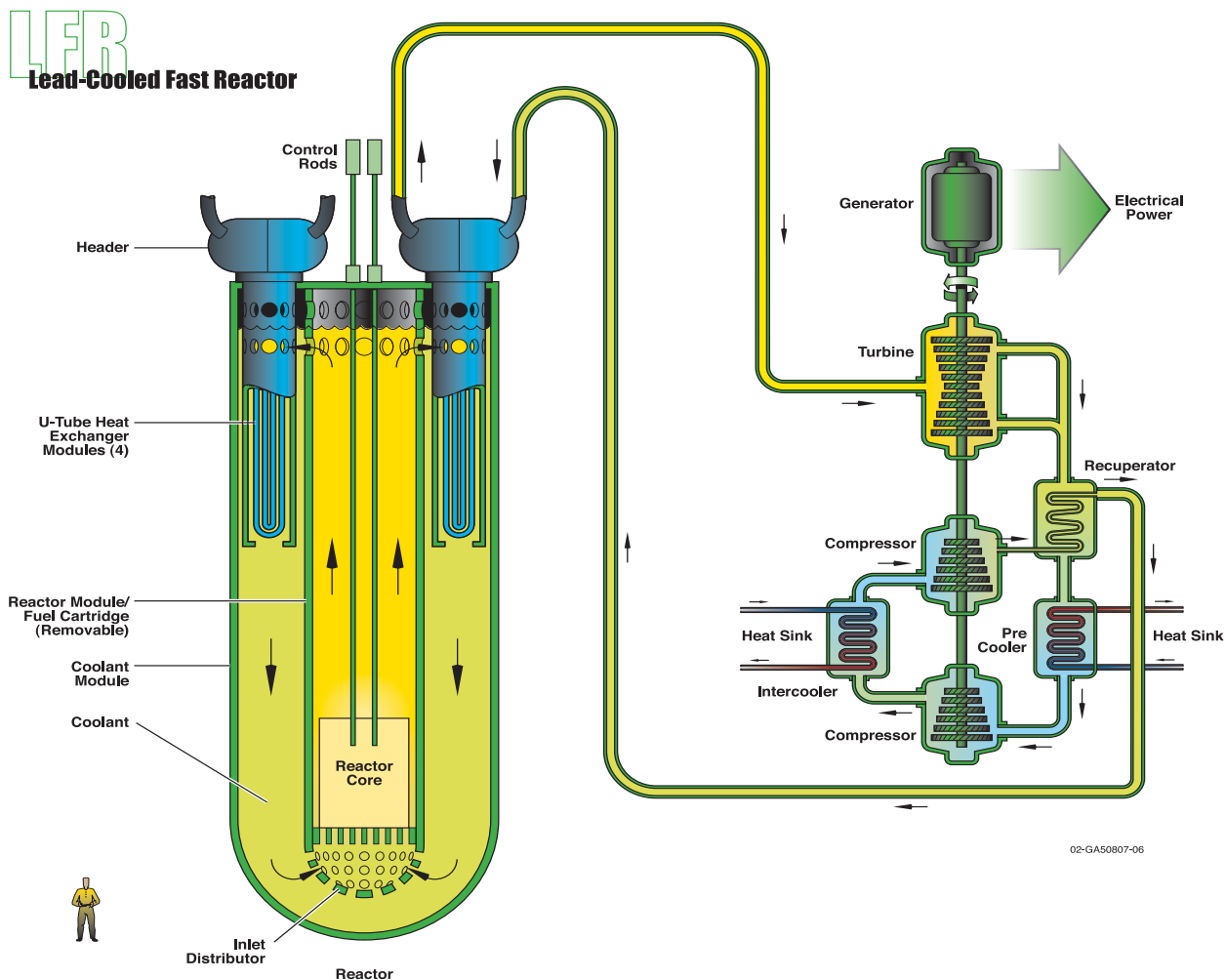

lift pumps, in-vessel steam generators, and other features. Innovations in energy conversion are afforded by rising to higher temperatures than liquid sodium allows, and by reaching beyond the traditional superheated Rankine steam cycle to supercritical Brayton or Rankine cycles or process heat applications such as hydrogen production and desalination.

- The favorable neutronics of Pb and Pb-Bi coolants in the battery option enable low power density, natural circulation-cooled reactors with fissile self-sufficient core designs that hold their reactivity over their very long 15- to 20-year refueling interval. For modular and large units more conventional higher power density, forced circulation, and shorter refueling intervals are used, but these units benefit from the improved heat transport and energy conversion technology.
- Plants with increased inherent safety and a closed fuel cycle can be achieved in the near- to mid-term. The longer-term option is intended for hydrogen production while still retaining the inherent safety features and controllability advantages of a heat transport circuit with large thermal inertia and a coolant that remains at ambient pressure. The favorable sustainability features of fast spectrum reactors with closed fuel cycles are also retained in all options.

- The favorable properties of Pb coolant and nitride fuel, combined with high temperature structural materials, can extend the reactor coolant outlet temperature into the 750–800°C range in the long term, which is potentially suitable for hydrogen manufacture and other process heat applications. In this option, the Bi alloying agent is eliminated, and the less corrosive properties of Pb help to enable the use of new high-temperature materials. The required R&D is more extensive than that required for the 550°C options because the higher reactor outlet temperature requires new structural materials and nitride fuel development.

A summary of the design parameters for the LFR systems is given in the following table.

Technology Base for the LFR

The technologies employed are extensions of those currently available from the Russian Alpha class submarine Pb-Bi alloy-cooled reactors, from the Integral Fast Reactor metal alloy fuel recycle and refabrication development, and from the ALMR passive safety and modular design approach. Existing ferritic stainless steel and metal alloy fuel, which are already significantly developed for sodium fast reactors, are adaptable to Pb-Bi cooled reactors at reactor outlet temperatures of 550°C.

Reactor Parameters	Reference Value			
	Pb-Bi Battery (nearer-term)	Pb-Bi Module (nearer-term)	Pb Large (nearer-term)	Pb Battery (far-term)
Coolant	Pb-Bi	Pb-Bi	Pb	Pb
Outlet Temperature (°C)	~550	~550	~550	750–800
Pressure (Atmospheres)	1	1	1	1
Rating (MWth)	125–400	~1000	3600	400
Fuel	Metal Alloy or Nitride	Metal Alloy	Nitride	Nitride
Cladding	Ferritic	Ferritic	Ferritic	Ceramic coatings or refractory alloys
Average Burnup (GWD/MTHM)	~100	~100–150	100–150	100
Conversion Ratio	1.0	$d \geq 1.0$	1.0–1.02	1.0
Lattice	Open	Open	Mixed	Open
Primary Flow	Natural	Forced	Forced	Natural
Pin Linear Heat Rate	Derated	Nominal	Nominal	Drated

Technology Gaps for the LFR

The important LFR technology gaps are in the areas of:

- LFR system fuels and materials, with some gaps remaining for the 550°C options, and large gaps for the 750–800°C option, including:
 - Nitride fuels development, including fuel/clad compatibility and performance
 - High-temperature structural materials
 - Environmental issues with lead.
- LFR system design, including:
 - Open lattice heat removal, both forced, and natural convective
 - Neutronic data and analysis tools
 - Coolant chemistry control, especially oxygen and ²¹⁰Po control
 - Innovative heat transport methods (such as design for natural circulation, lift pumps, in-vessel steam generators)

- Core internals support and refueling machinery
- Seismic isolation.

- LFR balance of plant, adapting supercritical steam Rankine or developing supercritical CO₂ electricity production technology, and crosscutting R&D on hydrogen production technology and heat exchangers for process heat applications
- LFR economics, focusing on modularization and factory fabrication
- LFR fuel cycle technology, including remote fabrication of metal alloy and TRU-N fuels.

Important viability and performance issues are found in all areas. Important R&D areas for each option are indicated in the table below.

International economic and regulatory developments are also needed for the cases where new regional fuel cycle centers owned by a consortium of clients operating under international safeguards close the fuel cycle and manage the waste.

Major R&D Areas	Pb-Bi Battery (nearer-term)	Pb-Bi Module (nearer-term)	Pb Large (nearer-term)	Pb Batter (far-term)
Metal Alloy or Nitride Fuel (esp. for higher temperature range)	x	x	x	x
High-Temperature Structural Materials				x
Natural Circulation Heat Transport in Open Lattice	x	x	x	x
Forced Circulation Heat Transport in Open Lattice	x	x	x	x
Coolant Chemistry Control	x	x	x	x
Innovative Heat Transport	x	x	x	x
Internals Support and Refueling	x	x	x	x
Energy Conversion:				
Supercritical CO ₂ Brayton	x	x		x
Supercritical Water Rankine		x	x	
Ca-Br Water Cracking				x
Desalinization Bottoming	x	x		x
Economics:				
Modularization	x	x	x	x
Modularization & Site Assembly	x	x	x	x
Metal Fuel Recycle/Refabrication	x	x		
Nitride Fuel Recycle/Refabrication	x	x	x	x

LFR Fuels and Materials R&D

The nearer-term options use metal alloy fuel, or nitride fuel if available. Metal alloy fuel pin performance at 550°C and U/TRU/Zr metal alloy recycle and remote refabrication technologies are substantially developed already in Na-cooled systems. Metal alloy fuel and recycle R&D is discussed in detail in the SFR and Crosscutting Fuel Cycle R&D sections, respectively.

Nitride Fuel. Mixed nitride fuel is also possible for the 550°C options; however, it is clearly required for the higher-temperature option. New fuel development will require a long R&D period, which should begin immediately. It is estimated that 10–15 years will be necessary to qualify any new fuel for the long-life service conditions in Pb or Pb-Bi. During the viability phase, R&D will be limited to finding a suitable cladding, developing a property-base for the nitride fuel, and preliminary in-pile testing.

Materials Screening. The top priority viability R&D areas for higher-temperature starts with materials screening for cladding, reactor internals, and heat exchangers. The primary approach will be to adapt modern materials developments such as composites, coatings, ceramics, and high-temperature alloys from other fields such as aerospace, and gas turbines. The goal is not only long service life but also cost effective fabrication using modern forming and joining technologies.

For the cladding, compatibility with Pb or Pb-Bi on the coolant side and mixed nitride fuel on the fuel side is required, and radiation damage resistance in a fast-neutron environment is required for a 15–20 year irradiation period. SiC or ZrN composites or coatings and refractory alloys are potential options for 800°C service, while standard ferritic steel is adequate at 550°C.

For process heat applications, an intermediate heat transport loop is needed to isolate the reactor from the energy converter for both safety assurance and product purity. Heat exchanger materials screening is needed for

potential intermediate loop fluids, including molten salts, He, CO₂, and steam. For interfacing with thermochemical water cracking, the chemical plant fluid is HBr plus steam at 750°C and low pressure. For interfacing with turbomachinery, the working fluid options are supercritical CO₂ or superheated or supercritical steam.

The material screening R&D will take the majority of the viability R&D time period and will require corrosion loops, posttest examination equipment, properties testing apparatus, phase diagram development, coolant chemistry control R&D, fabricability evaluations, and static and flowing in situ irradiation testing.

LFR Reactor Systems R&D

Chemistry Control. Viability R&D is also needed for chemistry and activation control of the coolant and corrosion products. Means for oxygen control are needed for both Pb and Pb-Bi options. Strategies and means for control of ²¹⁰Po, an activation product of Bi, is needed for the Pb-Bi option.

Thermal hydraulics. The heat removal from the fuel pin lattice (and also across intermediate heat exchanger tube bundles) uses natural or low-speed forced circulation through an open lattice of ductless assemblies. Heat transfer correlations, pressure drop correlations, pressure drop form factors for plenum flows and transitions, and flow redistribution patterns need to be developed as a function of geometry and pin linear heat rate both in the lattice and in the overall reactor flow circuit. The effects of grid spacers, deposits, and clad aging will have to be understood to support the long-term viability of natural circulation. This requires the availability of loops with a height useful for natural circulation, and also large-scale plenum flow facilities.

Neutronics. Neutronic data and computer codes also need to be validated through comparison of calculated neutronic parameters with measurements from critical experiment facilities. The need for improved evaluations of lead and bismuth cross sections should be assessed.

Reactor Components. Reactor internals support techniques and refueling, core positioning, and clamping strategies are issues because the internals and the fuel will float (unless restrained) in the dense coolant. In-service inspection technologies have to be developed.

LFR Balance-of-Plant R&D

R&D activity is recommended to support the LFR balance of plant in the areas of Ca-Br water cracking for hydrogen production, and a supercritical CO₂ Brayton cycle for energy conversion. These activities are found in the Crosscutting Energy Products R&D section.

LFR Safety R&D

The assurance of reliable and effective thermostructural reactivity feedback is key to the passive safety/passive load following design strategy and will require coordinated neutronics/thermal-hydraulics/structural design of the core. Preliminary testing of mixed nitride fuel under severe upset incore temperature conditions should also be conducted.

LFR Design and Evaluation R&D

Economics. Viability R&D activities are needed to determine whether economics can be achieved by plant simplification and reduced footprint, which is afforded by (1) the coolants being inert in air and water, (2) the high conversion efficiency using Brayton cycles or supercritical steam cycles, (3) the economies of mass production, modular assembly, and short onsite construction startup time, and (4) the production of energy products, possibly including the use of waste heat in a bottoming cycle.

Modular Construction. Achieving successful economics in the battery and modular options will depend on adaptation of factory-based mass production techniques from industries such as airplane, truck, and auto manu-

facture, and adaptation of modular/rapid site assembly used for ocean oil rig emplacement and shipbuilding. Life-cycle integrated economics analysis will also be needed that can address modern techniques in design, fabrication, transport, installation and startup, and monitoring and maintenance.

Plant Structures. The structural support of the reactor vessel, containing dense Pb or Pb-Bi coolant, will require design development in seismic isolation approaches and sloshing suppression. Also, concrete supports, if used, will have to either be cooled or be designed for high temperature service.

LFR Fuel Cycle R&D

The preferred option for the LFR fuel cycle is pyroprocessing, with advanced aqueous as an alternative. R&D recommended to generally develop the pyroprocess is found in the Crosscutting Fuel Cycle R&D section, although specialization is required to support the nitride fuel.

Nitride Fuel Recycle. Specialization anticipated for mixed nitride fuel recycle will need to address separations technology, remote refabrication technology, ¹⁵N enrichment technologies, and irradiation testing. Recycle and remote refabrication R&D activity in the viability phase should involve an iterative screening of conceptual recycle and refabrication approaches, bench scale testing, and flow sheet refinements. This work will build on existing programs in Japan and Europe, which are directed to partitioning and transmutation missions. Since ¹⁵N enrichment is essential to meeting sustainability goals for waste management (arising from the need to control ¹⁴C production), fuel cycle R&D activity should screen options for ¹⁵N enrichment and recovery and associated bench-scale investigations.

LFR R&D Schedule and Costs

A schedule for the LFR R&D is shown below, along with the R&D costs and decision points.

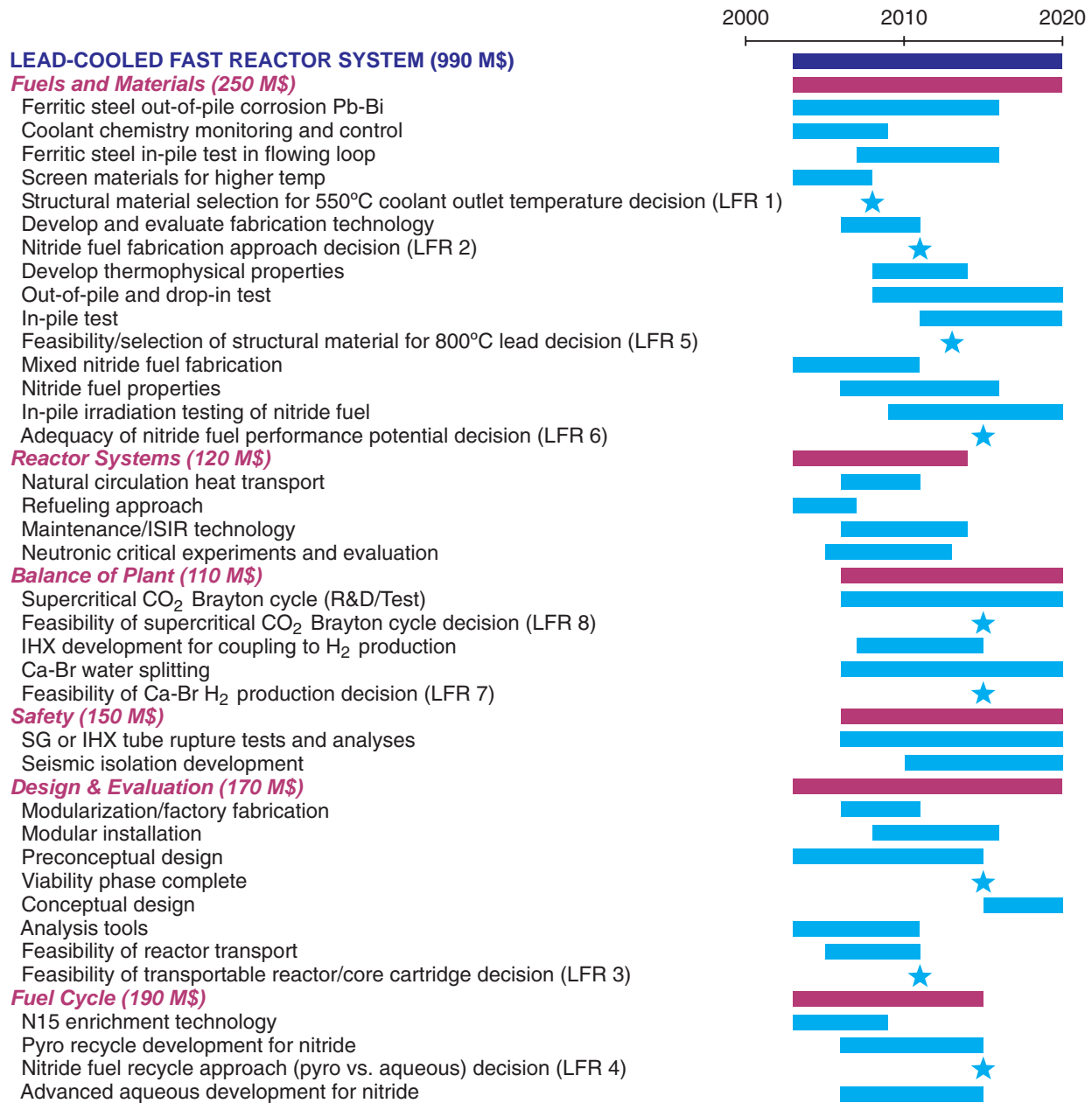

Molten Salt Reactor System R&D

MSR Description

The MSR produces fission power in a circulating molten salt fuel mixture [an MSR is shown below]. MSRs are fueled with uranium or plutonium fluorides dissolved in a mixture of molten fluorides, with Na and Zr fluorides as the primary option. MSRs have the following unique characteristics, which may afford advances:

- MSRs have good neutron economy, opening alternatives for actinide burning and/or high conversion
- High-temperature operation holds the potential for thermochemical hydrogen production

- Molten fluoride salts have a very low vapor pressure, reducing stresses on the vessel and piping
- Inherent safety is afforded by fail-safe drainage, passive cooling, and a low inventory of volatile fission products in the fuel
- Refueling, processing, and fission product removal can be performed online, potentially yielding high availability
- MSRs allow the addition of actinide feeds of widely varying composition to the homogenous salt solution without the blending and fabrication needed by solid fuel reactors.

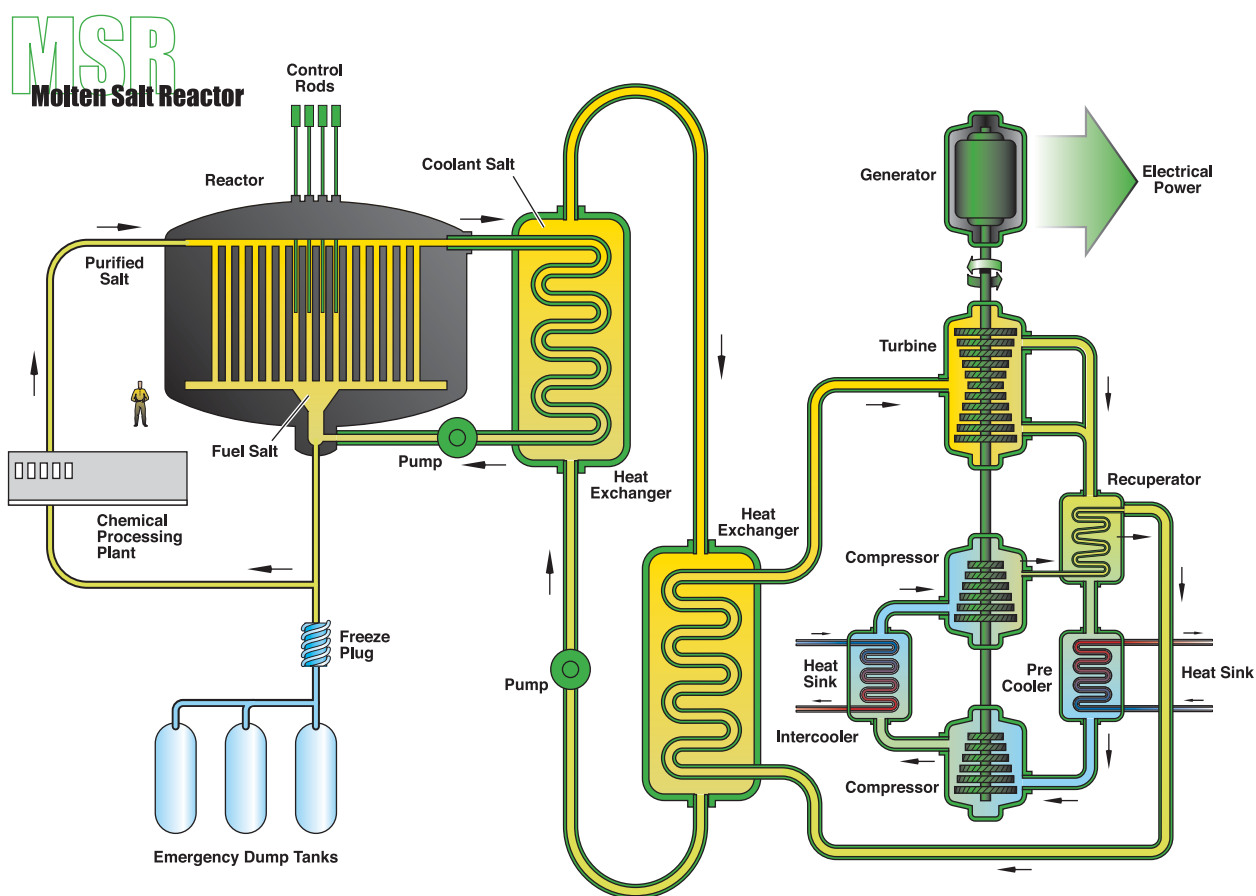

There are four fuel cycle options: (1) Maximum conversion ratio (up to 1.07) using a Th-²³³U fuel cycle, (2) denatured Th-²³³U converter with minimum inventory of nuclear material suitable for weapons use, (3) denatured once-through actinide burning (Pu and minor actinides) fuel cycle with minimum chemical processing, and (4) actinide burning with continuous recycling. The fourth option with electricity production is favored for the Generation IV MSR. Fluoride salts with higher solubility for actinides such as NaF/ZrF₄ are preferred for this option. Salts with lower potential for tritium production would be preferred if hydrogen production were the objective. Lithium and beryllium fluorides would be preferred if high conversion were the objective. Online processing of the liquid fuel is only required for high conversion to avoid parasitic neutron losses of ²³³Pa that decays to ²³³U fuel. Offline fuel salt processing is acceptable for actinide management and hydrogen or electricity generation missions. To achieve conversion ratios similar to LWRs, the fuel salt needs only to be replaced every few years.

The reactor can use ²³⁸U or ²³²Th as a fertile fuel dissolved as fluorides in the molten salt. Due to the thermal or epithermal spectrum of the fluoride MSR, ²³²Th achieves the highest conversion factors. All of the MSRs may be started using low-enriched uranium or other fissile materials. The range of operating temperatures of MSRs ranges from the melting point of eutectic fluorine salts (about 450°C) to below the chemical compatibility temperature of nickel-based alloys (about 800°C).

A summary of the reference design parameters for the MSR is given in the following table.

Reactor Parameters	Reference Value
Net power	1000 MWe
Power density	22 MWth/m ³
Net thermal efficiency	44 to 50%
Fuel-salt – inlet temperature	565°C
– outlet temperature	700°C (850°C for hydrogen production)
– vapor pressure	<0.1 psi
Moderator	Graphite
Power Cycle	Multi-reheat recuperative helium Brayton cycle
Neutron spectrum burner	Thermal–actinide

Technology Base for the MSR

MSRs were first developed in the late 1940s and 1950s for aircraft propulsion. The Aircraft Reactor Experiment (ARE) in 1954 demonstrated high temperatures (815°C) and established benchmarks in performance for a circulating fluoride molten salt (NaF/ZrF₄) system. The 8 MWth Molten Salt Reactor Experiment (MSRE) demonstrated many features, including (1) a lithium/beryllium fluoride salt, (2) graphite moderator, (3) stable performance, (4) off-gas systems, and (5) use of different fuels, including ²³⁵U, ²³³U, and plutonium. A detailed 1000 MWe engineering conceptual design of a molten salt reactor was developed. Under these programs, many issues relating to the operation of MSRs as well as the stability of molten salt fuel and its compatibility with graphite and Hastelloy N were resolved.

Technology Gaps for the MSR

The MSR has a number of technical viability issues that need to be resolved. The highest priority issues include molten salt chemistry, solubility of actinides and lanthanides in the fuel, compatibility of irradiated molten salt fuel with structural materials and graphite, and metal clustering in heat exchangers. Specific areas of this viability research phase include:

- Solubility of minor actinides and lanthanides in molten fluoride salt fuel for actinide management with high actinide concentrations
- Lifetime behavior of the molten salt fuel chemistry, and fuel processing during operation and eventual disposal in a final waste form
- Materials compatibility with both fresh and irradiated molten salt fuel for higher temperature applications
- Metal clustering (noble metals plate-out on of the heat exchanger primary wall)
- Salt processing, separation, and reprocessing technology development, including a simplification of the flowsheet.

The initial viability R&D phase is complemented by studies to establish conceptual design and preliminary technical specifications for the reactor and power generation cycle.

The issues in the performance R&D phase include:

- Fuel development, new cross section data, and qualifications to enable selection of the molten salt composition

- Corrosion and embrittlement studies to determine lifetimes of materials and reliability
- Development of tritium control technology
- Molten salt chemistry control, REDOX control, liquid-liquid extraction, and salt purification
- Graphite sealing technology and graphite stability improvement and testing
- Detailed conceptual design studies to develop design specifications.

MSR Fuels and Materials R&D

The main objective of the fuel characterization research is to develop a simple and reliable chemistry flowsheet that is complete from initial fuel loading to the final waste form. Fundamental research needs to be conducted to determine kinetic and thermodynamic data, fully characterize fission product behavior, and determine the optimum process for separating fission products, including lanthanides without removal of minor actinides. Research on solubility of minor actinides and lanthanides will generate critical data needed to design reactors capable of burning minor actinides with minimum inventories in the reactor.

Fuel Salt Selection. The fuel salt has to meet requirements that include neutronic properties (low neutron cross section for the solvent components, radiation stability, negative temperature coefficient), thermal and transport properties (low melting point, thermal stability, low vapor pressure, adequate heat transfer and viscosity), chemical properties (high solubility of fuel components, compatibility with container and moderator materials, ease of fuel reprocessing), compatibility with waste forms, and low fuel and processing costs. To operate the reactor as an actinide burner increases the concentration of fission and transuranic elements in the core, which in turn requires a higher solubility than prior art. Thus, new salt compositions such as sodium and zirconium fluorides should be investigated. Sodium has a higher neutron absorption cross section and is thus somewhat less favorable neutronicly. However, this drawback can be partially compensated for by increasing the fuel enrichment. Furthermore, selection of NaF-ZrF₄ instead of BeF₂ increases the solubility of the salt and decreases the tritium production. Furthermore, NaF-ZrF₄ and related salts, with a high percentage of thorium dissolved in it, are thought to have a better temperature reactivity coefficient.

Cross Sections and New Fuel Data. Despite the successes of the prototypes, recent neutronics calculations raise questions about the value of the temperature reactivity coefficient of the fuel salt. To gain confidence, new data measurements and qualification are needed.

Metallic Components. Materials compatibility testing requires design and operation of a test loop where accelerated irradiation testing could be conducted using fissile and fertile fuel. The primary outcome of this research is to identify and address fission product reactions (if any) and to measure mechanical properties and demonstrate lifetime performance of structural materials in the MSR. Test materials should include nickel based alloys with demonstrated performance in MSR test programs of the 1950s and 1960s such as INOR-8, Hastelloy B and N, and Inconel, as well as other promising materials such as niobium-titanium alloys, for which lifetime performances have not yet been demonstrated.

The nickel based alloys have been proven as suitable MSR structural materials. INOR-8 is strong, stable, corrosion-resistant, and has good welding and forming characteristics. It is fully compatible with graphite, with nonsodium salts up to 815°C and with sodium salts up to 700°C. Modified Hastelloy N, developed for use with fluoride salt at high temperature (up to 800°C), has proven to be corrosion resistant but requires longer-term testing. For nongraphite core concepts, it must be noted that nickel based alloys are sensitive to He-induced embrittlement under irradiation, resulting in a reduction of the creep ductility of the alloy. Tests show that titanium addition (up to 2%) solves the embrittlement problem and increases resistance to tellurium attack, which can also be strongly mitigated by making the salt more reducing. Additional testing of corrosion effects due to molten salt in a thermal gradient, tellurium embrittlement, and irradiation effects on mechanical properties are all required to have full confidence in the lifetime performance of these alloys.

Graphite. Graphite's primary function is to provide neutron moderation. Radiation damage will require graphite replacement every 4 to 10 years, similar to the requirements for the VHTR moderator blocks. Longer-lived graphite directly improves plant availability because the MSR does not need refueling outages. This is a driver for research into graphite with improved performance.

Secondary Coolant Salt Selection. The secondary salt operates in significantly less damaging conditions than the primary system. The temperature is lower, there are no fission products or actinides in the salt, and the neutron fluence is much lower in the secondary system. The secondary circuit metal must resist corrosion by the coolant salt, which could be the same as the primary coolant or a fluoroborate (mixture of NaBF_4 and NaF). However, additional research is needed to ensure that this salt will be satisfactory. The salt selected will partly depend on the choice of power conversion cycle. This salt is more corrosive toward Hastelloy N than the fuel salt, and additional knowledge of corrosion reactions is required.

MSR Balance-of-Plant R&D

Power Cycle. Historically, it has been assumed that a steam power cycle would be used to produce electricity. Recent studies indicate that use of an advanced helium gas turbine for electricity production would increase efficiency, reduce costs, provide an efficient mechanism to trap tritium, and avoid potential chemical reactions between the secondary coolant salt and the power cycle fluid. Additional research is recommended to confirm these benefits and develop such systems.

Component Technology. Prior programs demonstrated molten salt pump operation up to 17 000 hours. Research into longer life pumps is required to achieve economic performance goals. In addition, shields need to be developed for the motor, seal, and bearings.

Noble metals that plate-out on heat exchanger walls (metal clustering) are an operational issue that scales with the power level of the MSR. In the case of loss of heat sink, the radiation thermal load of the metal clusters could cause significant damage leading to loss of integrity of the MSR intermediate heat exchanger. Bismuth wash, filters, and inclusion of additives to the molten salt are approaches for preventing the metal clustering issue in MSRs. This research should begin with an out-of-pile test loop using salt with noble metals.

The main challenge concerning valves, joints, and fittings is to ensure correct mating of surfaces ranging from room temperature to 700°C . Avoiding fusion bonding with the molten salt is also a technical challenge for efficient valve operation, and tests will have to be carried out to improve reliability.

MSR Safety R&D

Reactor Safety. Prior programs have provided information to help demonstrate MSR safety. Nevertheless, a comprehensive safety analysis equivalent to those for current reactors remains to be done. Additional technology demonstration is needed in this area.

MSR Design and Evaluation R&D

Detailed design of a MSR has not been done since 1970. An updated design (including design tradeoff studies) is required to better understand strengths and weaknesses and allow defensible economic evaluations. The current regulatory structure is designed for solid fuel reactors, and the MSR design needs to carefully address the intent of current regulations. Work is required with regulators to define equivalence in safety for MSRs. Because the MSR shares many features with reprocessing plants, the development of MSR regulatory and licensing approaches should be coordinated with R&D in pyroprocessing. Under the high radiation and temperature environment, remote and robotic maintenance, inspection, and repair are key technologies that require R&D.

Fuel Salt In-Line Composition Measurement. Operation of a MSR requires that adequate surveillance be maintained on the composition of various reactor streams, such as the redox potential of the salt (which is indicated by the $\text{U}^{3+}/\text{U}^{4+}$ ratio). Electroanalytical measurement techniques will need to be developed.

MSR Fuel Cycle R&D

Significant R&D activity is required in salt processing and quality. Earlier work on salt processing developed and demonstrated flowsheets on a laboratory scale to remove radionuclides from the salt and maximize the conversion ratio. The process was divided into multiple tiers, which induced large volumes of salt and wastes in the salt processing. A key need is to develop a simple process with a conversion ratio near one and which is optimized for transmutation of actinides from other reactors. This may allow flowsheet simplification and lesser constraints on the recovery rate of fission products. In addition, considerable R&D is required to develop waste forms for the MSR fuel cycle.

R&D activity is also recommended to understand proliferation resistance and physical protection issues and their impact on the MSR design.

MSR R&D Schedule and Costs

A schedule for the MSR R&D is shown below, along with the R&D costs and decision points.

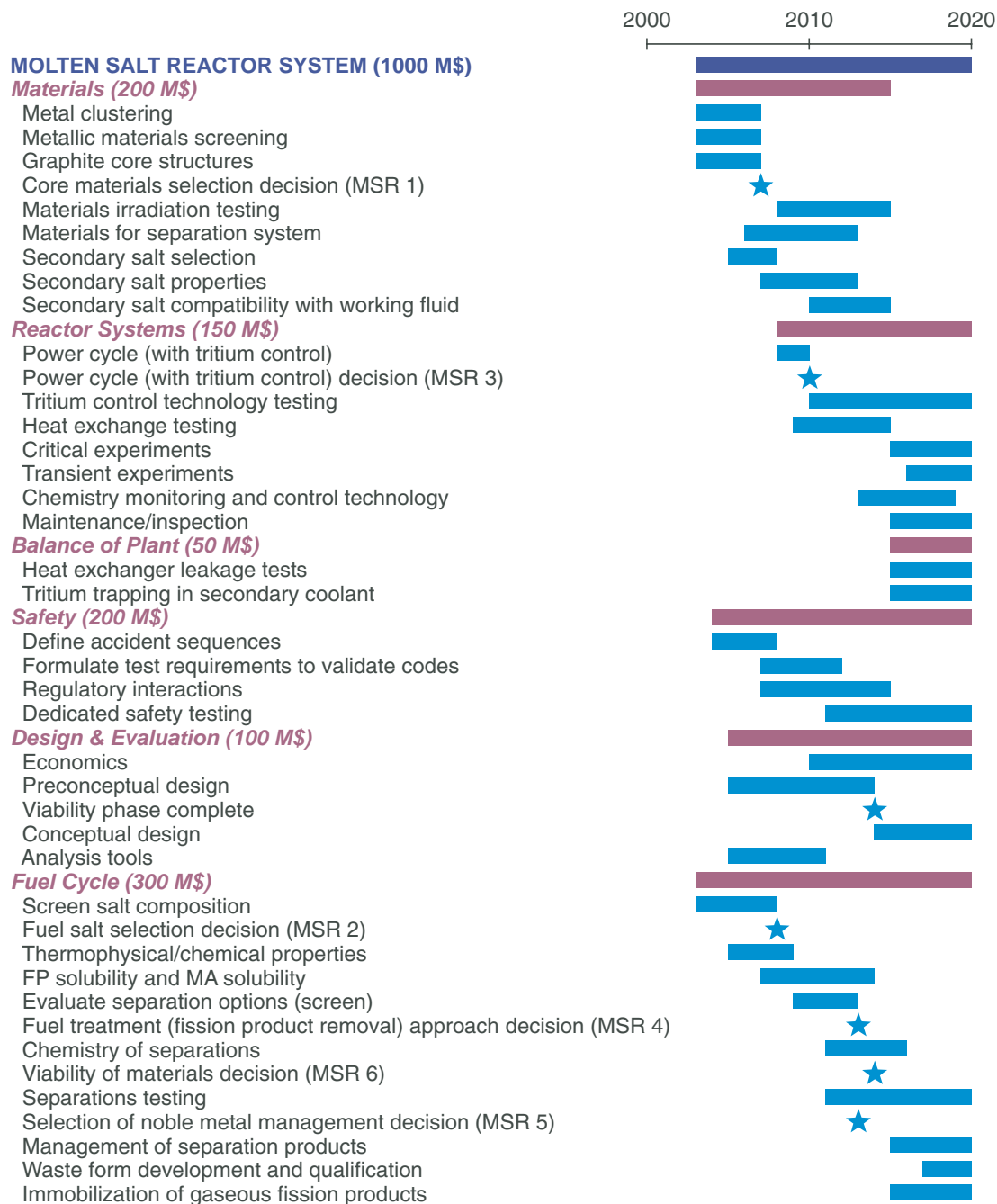

Sodium-Cooled Fast Reactor System R&D

SFR Description

The Sodium-Cooled Fast Reactor (SFR) system features a fast-spectrum reactor [shown below] and closed fuel recycle system. The primary mission for the SFR is management of high-level wastes and, in particular, management of plutonium and other actinides. With innovations to reduce capital cost, the mission can extend to electricity production, given the proven capability of sodium reactors to utilize almost all of the energy in the natural uranium versus the 1% utilized in thermal spectrum systems.

A range of plant size options are available for the SFR, ranging from modular systems of a few hundred MWe to large monolithic reactors of 1500–1700 MWe. Sodium-core outlet temperatures are typically 530–550°C. The primary coolant system can either be arranged in a pool layout (a common approach, where all primary system components are housed in a single vessel), or in a compact loop layout, favored in Japan. For both options, there is a relatively large thermal inertia of the primary coolant. A large margin to coolant boiling is achieved by design, and is an important safety feature of these systems. Another major safety feature is that the pri-

mary system operates at essentially atmospheric pressure, pressurized only to the extent needed to move fluid. Sodium reacts chemically with air, and with water, and thus the design must limit the potential for such reactions and their consequences. To improve safety, a secondary sodium system acts as a buffer between the radioactive sodium in the primary system and the steam or water that is contained in the conventional Rankine-cycle power plant. If a sodium-water reaction occurs, it does not involve a radioactive release.

Two fuel options exist for the SFR: (1) MOX and (2) mixed uranium-plutonium-zirconium metal alloy (metal). The experience with MOX fuel is considerably more extensive than with metal.

SFRs require a closed fuel cycle to enable their advantageous actinide management and fuel utilization features. There are two primary fuel cycle technology options: (1) an advanced aqueous process, and (2) the *pyroprocess*, which derives from the term, pyrometallurgical process. Both processes have similar objectives: (1) recovery and recycle of 99.9% of the actinides, (2) inherently low decontamination factor of the product, making it highly radioactive, and (3) never separating plutonium at any stage. These fuel cycle technologies must be adaptable

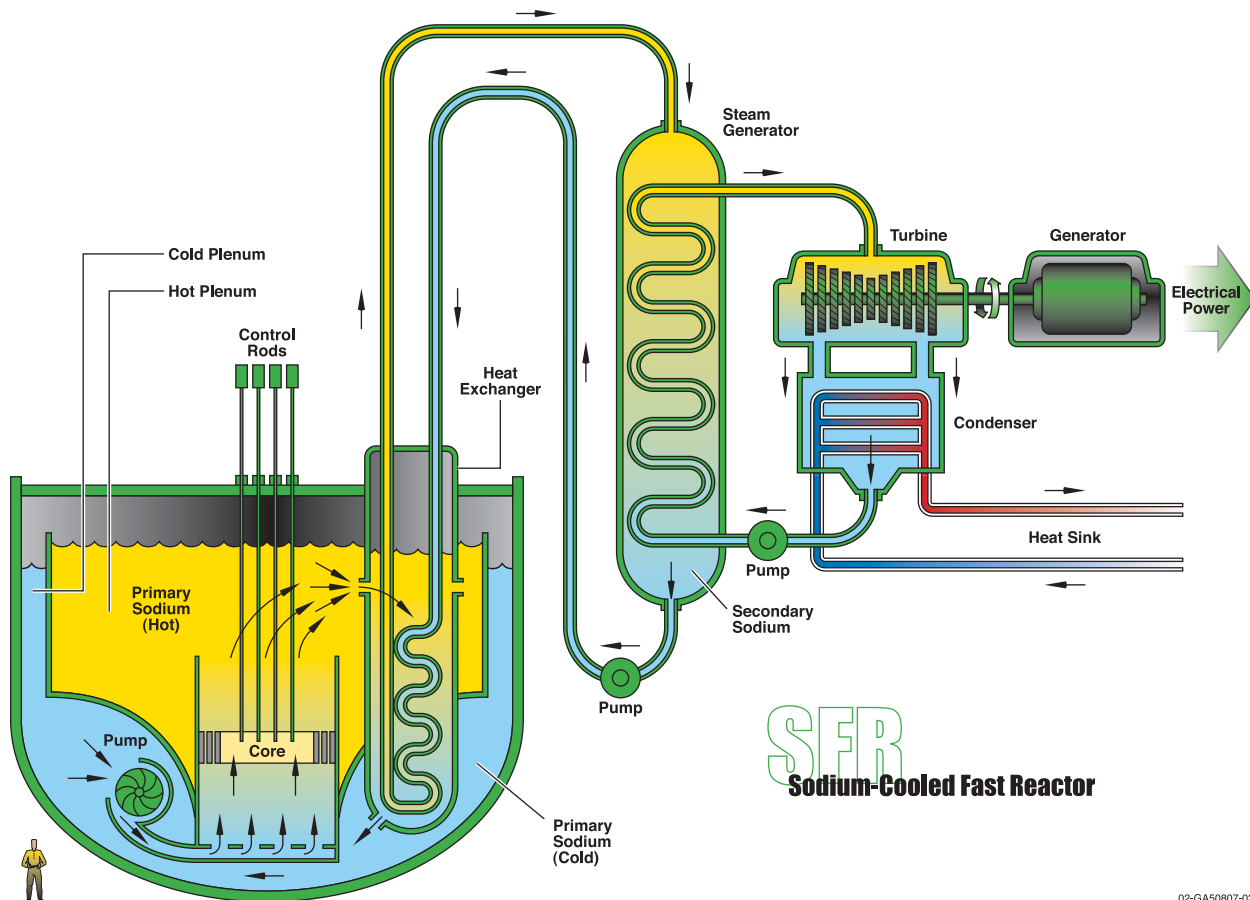

to thermal spectrum fuels in addition to serving the needs of the SFR. This is needed for two reasons: First, the startup fuel for the fast reactors must come ultimately from spent thermal reactor fuel. Second, for the waste management advantages of the advanced fuel cycles to be realized (namely, a reduction in the number of future repositories required and a reduction in their technical performance requirements), fuel from thermal spectrum plants will need to be processed with the same recovery factors. Thus, the reactor technology and the fuel cycle technology are strongly linked. Consequently, much of the research recommended for the SFR is relevant to crosscutting fuel cycle issues.

A summary of the design parameters for the SFR system is given in the following table.

Reactor Parameters	Reference Value
Outlet Temperature	530-550 °C
Pressure	~1 Atmospheres
Rating	1000-5000 MWth
Fuel	Oxide or metal alloy
Cladding	Ferritic or ODS ferritic
Average Burnup	~150-200 GWD/MTHM
Conversion Ratio	0.5-1.30
Average Power Density	350 MWth/m ³

Technology Base for the SFR

Sodium-cooled liquid metal reactors are the most technologically developed of the six Generation IV systems. SFRs have been built and operated in France, Japan, Germany, the United Kingdom, Russia, and the United States. Demonstration plants ranged from 1.1 MWth (at EBR-I in 1951) to 1200 MWe (at SuperPhenix in 1985), and sodium-cooled reactors are operating today in Japan, France, and Russia. As a benefit of these previous investments in technology, the majority of the R&D needs presented for the SFR in this roadmap are performance-related. With the exception of passive safety assurance, there are few viability issues with regard to the reactor systems.

The fuel options for the SFR are MOX and metal. Both are highly developed as a result of many years of work in several national reactor development programs. Burnups in the range of 150–200 GWD/MTHM have been experimentally demonstrated for both. Nevertheless, the databases for oxide fuels are considerably more extensive than those for metal fuels.

There is an extensive technology base in nuclear safety that establishes the passive safety characteristics of the SFR and their ability to accommodate all of the classical anticipated transients without scram events without fuel damage. Landmark tests of two of these events were done in RAPSODIE (France) in 1983 and in EBR-II (United States) in 1986. Still, there is important viability work to be done in safety. Key needs are to confirm reliability of passive feedback from heatup of reactor structures and to establish the long-term coolability of oxide or metal fuel debris after a bounding case accident.

The options for fuel recycle are the advanced aqueous process and the pyroprocess. The technology base for the advanced aqueous process comes from the long and successful experience in several countries with PUREX process technology. The advanced process proposed by Japan, for example, is simplified relative to PUREX and does not result in highly purified products. The technology base for fabrication of oxide fuel assemblies is substantial, yet further extension is needed to make the process remotely operable and maintainable. The high-level waste form from advanced aqueous processing is vitrified glass, for which the technology is well established.

The pyroprocess has been under development since the inception of the Integral Fast Reactor program in the United States in 1984. When the program was cancelled in 1994, pyroprocess development continued in order to treat EBR-II spent fuel for disposal. In this latter application, plutonium and minor actinides were not recovered, and pyroprocess experience with these materials remains at laboratory scale. Batch size for uranium recovery, however, is at the tens-of-kilogram scale, about that needed for deployment. Remote fabrication of metal fuel was demonstrated in the 1960s. Significant work has gone into repository certification of the two high-level waste forms from the pyroprocess, a glass-bonded mineral (ceramic) and a zirconium-stainless steel alloy.

Technology Gaps for the SFR

The important technology gaps for the SFR are in the areas of:

- Ensuring of passive safe response to all design basis initiators, including anticipated transients without scram (a major advantage for these systems)
- Capital cost reduction
- Proof by test of the ability of the reactor to accommodate bounding events

- Scale-up of the pyroprocess with demonstration of high minor actinide recovery
- Development of oxide fuel fabrication technology with remote operation and maintenance.

The main viability issues for the reactor in the SFR system relate to accommodating bounding events. Assurance or verification of passive safety is an important performance issue. Some consider the acquisition of irradiation performance data for fuels fabricated with the new fuel cycle technologies to also be a viability issue, rather than a performance issue. Other important SFR reactor technology gaps are in-service inspection and repair (in sodium), and completion of the fuels database.

A key performance issue for the SFR is cost reduction to competitive levels. The extent of the technology base for SFRs is noted above, yet none of the SFRs constructed to date have been economical to build or operate. However, design studies have been done, some of them very extensively, in which proponents conclude that both overnight cost and busbar cost can be comparable to or lower than those of the advanced LWRs. Ultimately, cost reductions are best if supported by specific innovations, providing a better measure of confidence. In S-PRISM, the key cost reduction is its modular construction. In Japanese design studies at the Japan Nuclear Cycle Development Institute, for example, innovations such as (1) a reduced number of primary loops, (2) an integral pump and intermediate heat exchanger, and (3) the use of improved materials of construction are the basis for cost reductions.

With the advanced aqueous fuel cycle, the key viability issue is the minimal experience with production of ceramic pellets (using remotely operated and maintained equipment) that contain minor actinides and trace amounts of fission products. Further, it is important to demonstrate scale-up of the uranium crystallization step. Filling both of these gaps is key to achieving cost goals.

For the pyroprocess, viability issues include lack of experience with larger-scale plutonium and minor actinide recoveries, minimal experience with drawdown equipment for actinide removal from electrorefiner salts before processing, and minimal experience with ion exchange systems for reducing ceramic waste volume.

SFR Fuels and Materials R&D

The fuel options for the SFR are MOX and metal alloy. Either will contain a relatively small fraction of minor actinides and, with the low-decontamination fuel cycle processes contemplated, also a small amount of fission

products. The presence of the minor actinides and fission products dictates that fuel fabrication be performed remotely. This creates the need to verify that this remotely fabricated fuel will perform adequately in the reactor.

These minor actinide-bearing fuels also require further property assessment work for both fuel MOX and metal fuels, but more importantly for metal fuels. Also for metal fuels, it is important to confirm fuel/cladding constituent interdiffusion behavior when minor actinides and additional rare earth elements are present.

SFR Reactor Systems R&D

Economics. As noted, key performance R&D remains for sodium-cooled reactors because of the existing knowledge and experience accumulated in this field. The reactor technology R&D that remains is aimed at enhancing the economic competitiveness and plant availability. For example, development and/or selection of structural materials for components and piping is important to development of an economically competitive plant. 12% Cr ferritic steels, instead of austenitic steels, are viewed as promising structural materials for future plant components because of their superior elevated temperature strength and thermal properties, including high thermal conductivity and low thermal expansion coefficient.

In-Service Inspection, Maintenance, and Monitoring. Improvement of in-service inspection and repair technologies is important to confirm the integrity of safety-related structures and boundaries that are submerged in sodium, and to repair them in place. Motivated by the need to address sodium-water reactions, it is also important to enhance the reliability of early detection systems for water leaks. New early detection systems, especially those that protect against small leaks, would be adopted to prevent the propagation of tube ruptures and to allow a rapid return to plant operation.

SFR Balance-of-Plant R&D

Noting the temperatures at which the SFRs operate, there may be interest in investigating the use of a supercritical CO₂ Brayton cycle. This cycle is discussed in the Crosscutting Energy Products R&D section.

SFR Safety R&D

A focused program of safety R&D is necessary to support the SFR. Worldwide experience with design and operation of such systems has shown that they can be operated reliably and safely. The safety R&D challenges for these systems in the Generation IV context are (1) to

verify the predictability and effectiveness of the mechanisms that contribute to passively safe response to design basis transients and anticipated transients without scram, and (2) to ensure that bounding events considered in licensing can be sustained without loss of coolability of fuel or loss of containment function.

In-Pile Experiments. Since many of the mechanisms that are relied upon for passively safe response can be predicted on a first-principles basis (for example, thermal expansion of the fuel and core grid plate structure), enough is now known to perform a conceptual design of a prototype reactor. R&D is recommended to evaluate physical phenomena and design features that can be important contributors to passive safety, and to establish coolability of fuel assemblies if damage should occur. This R&D would involve in-pile experiments, primarily on metal fuels, using a transient test facility.

Accommodation of Bounding Events. The second challenge requires analytical and experimental investigations of mechanisms that will ensure passively safe response to bounding events that lead to fuel damage. The principal needs are to show that debris resulting from fuel failures is coolable within the reactor vessel,

and to show that passive mechanisms exist to preclude recriticality in a damaged reactor. A program of out-of-pile experiments involving reactor materials is recommended for metal fuels, while in-pile investigations of design features for use with oxide fuel are now underway.

SFR Design and Evaluation R&D

While there are design studies in progress in Japan on SFRs, there is little design work in the United States, even at the preconceptual level. Design work is an important performance issue, and it should accelerate given the importance of economics for the SFR. R&D activity is needed with a focus on the base technology for component development.

SFR Fuel Cycle R&D

R&D activity is recommended to support the SFR fuel cycle found in the Crosscutting Fuel Cycle R&D section.

SFR R&D Schedule and Costs

A schedule for the SFR R&D is shown below, along with the R&D costs and decision points. The schedule reflects the advancement of both oxide and metal fuel options for the SFR.

SODIUM-COOLED FAST REACTOR SYSTEM (610 M\$)

Fuels and Materials (160 M\$)

Oxide

- Advanced pelletizing technology
- Oxide fuel remote fabrication technology selection decision (SFR 1)
- ODS cladding (welding)
- Remote maintenance development
- Vibrocompaction alternative
- ODS MOX fuel pin irradiation

Metal

- Characterize MA bearing fuels
- Reduce actinide losses in fabric
- Advanced cladding out-of-pile tests
- Irradiation tests for MA bearing fuels

New materials development (12% Cr ferritic steels)

Reactor Systems (140 M\$)

- In-service inspection and repair technology

Balance of Plant (50 M\$)

- Increased reliability steam generators

Safety (160 M\$)

- Passive safety confirmation
- SASS development
- Transient fuel testing and analysis

Severe accident behavior testing

- Debris co-stability
- Molten fuel discharge/dispersal

Design & Evaluation (100 M\$)

- Evaluate supercritical CO₂ turbine
- Preconceptual design
- Viability phase complete
- Conceptual design
- Analysis tools

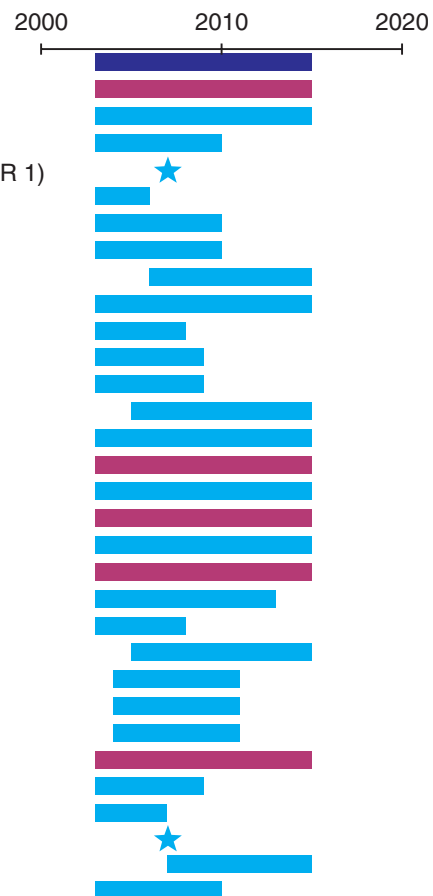

Supercritical-Water-Cooled Reactor System R&D

SCWR Description

SCWRs are high-temperature, high-pressure water-cooled reactors that operate above the thermodynamic critical point of water (374°C, 22.1 MPa or 705°F, 3208 psia). One SCWR system is shown below. These systems may have a thermal or fast-neutron spectrum, depending on the core design. SCWRs have unique features that may offer advantages compared to state-of-the-art LWRs in the following:

- SCWRs offer increases in thermal efficiency relative to current-generation LWRs. The efficiency of a SCWR can approach 44%, compared to 33–35% for LWRs.
- A lower-coolant mass flow rate per unit core thermal power results from the higher enthalpy content of

the coolant. This offers a reduction in the size of the reactor coolant pumps, piping, and associated equipment, and a reduction in the pumping power.

- A lower-coolant mass inventory results from the once-through coolant path in the reactor vessel and the lower-coolant density. This opens the possibility of smaller containment buildings.
- No boiling crisis (i.e., departure from nucleate boiling or dry out) exists due to the lack of a second phase in the reactor, thereby avoiding discontinuous heat transfer regimes within the core during normal operation.
- Steam dryers, steam separators, recirculation pumps, and steam generators are eliminated. Therefore, the SCWR can be a simpler plant with fewer major components.

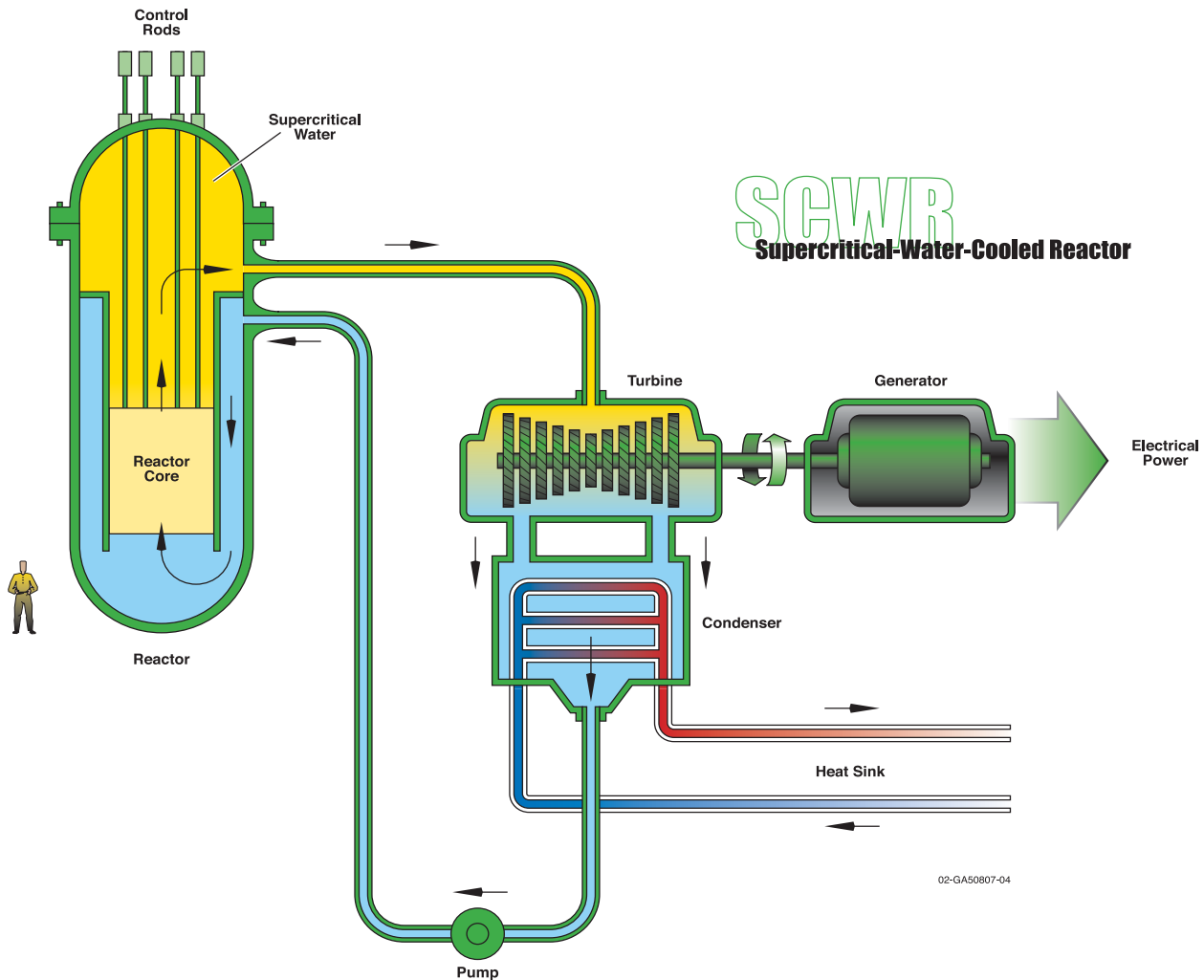

The Japanese supercritical light water reactor (SCLWR) with a thermal spectrum has been the subject of the most development work in the last 10 to 15 years and is the basis for much of the reference design. The SCLWR reactor vessel is similar in design to a PWR vessel (although the primary coolant system is a direct-cycle, BWR-type system). High-pressure (25.0 MPa) coolant enters the vessel at 280°C. The inlet flow splits, partly to a downcomer and partly to a plenum at the top of the core to flow down through the core in special water rods. This strategy provides moderation in the core. The coolant is heated to about 510°C and delivered to a power conversion cycle, which blends LWR and supercritical fossil plant technology; high-, intermediate- and low-pressure turbines are employed with two reheat cycles. The overnight capital cost for a 1700-MWe SCLWR plant may be as low as \$900/kWe (about half that of current ALWR capital costs), considering the effects of simplification, compactness, and economy of scale. The operating costs may be 35% less than current LWRs.

The SCWR can also be designed to operate as a fast reactor. The difference between thermal and fast versions is primarily the amount of moderator material in the SCWR core. The fast spectrum reactors use no additional moderator material, while the thermal spectrum reactors need additional moderator material in the core.

A summary of designs parameters for the SCWR system is given in the following table.

Reactor Parameters	Reference Value
Plant capital cost	\$900/KW
Unit power and neutron spectrum	1700 MWe, thermal spectrum
Net efficiency	44%
Coolant inlet and outlet temperatures and pressure	280°C/510°C/25 MPa
Average power density	~100 MWth/m ³
Reference fuel	UO ₂ with austenitic or ferritic-martensitic stainless steel, or Ni-alloy cladding
Fuel structural materials cladding structural materials	Advanced high-strength metal alloys are needed
Burnup / Damage	~45 GWD/MTHM; 10–30 dpa
Safety approach	Similar to ALWRs

Technology Base for the SCWR

Much of the technology base for the SCWR can be found in the existing LWRs and in commercial supercritical-water-cooled fossil-fired power plants. However, there are some relatively immature areas. There have been no prototype SCWRs built and tested. For the reactor primary system, there has been very little in-pile research done on potential SCWR materials or designs, although some SCWR in-pile research has been done for defense programs in Russia and the United States. Limited design analysis has been underway over the last 10 to 15 years in Japan, Canada, and Russia. For the balance of plant, there has been development of turbine generators, piping, and other equipment extensively used in supercritical-water-cooled fossil-fired power plants. The SCWR may have some success at adopting portions of this technology base.

Technology Gaps for the SCWR

The important SCW technology gaps are in the areas of:

- SCWR materials and structures, including
 - Corrosion and stress corrosion cracking (SCC)
 - Radiolysis and water chemistry
 - Dimensional and microstructural stability
 - Strength, embrittlement, and creep resistance
- SCWR safety, including power-flow stability during operation
- SCWR plant design.

Important viability issues are found within the first two areas, and performance issues are found primarily within the first and third areas.

SCWR Fuels and Materials R&D

The supercritical water (SCW) environment is unique and few data exist on the behavior of materials in SCW under irradiation and in the temperature and pressure ranges of interest. At present, no candidate alloy has been confirmed for use as either the cladding or structural material in thermal or fast spectrum SCWRs. Potential candidates include austenitic stainless steels, solid solution and precipitation-hardened alloys, ferritic-martensitic alloys, and oxide dispersion-strengthened alloys.

The fast SCWR design would result in greater doses to cladding and structural materials than in the thermal design by a factor of 5 or more. The maximum doses for

the core internals are in the 10–30 dpa range in the thermal design, and could reach 100–150 dpa in the fast design. These doses will result in greater demands on the structural materials in terms of the need for irradiation stability and effects of irradiation on embrittlement, creep, corrosion, and SCC. The generation of helium by transmutation of nickel is also an important consideration in both the thermal and fast designs because it can lead to swelling and embrittlement at high temperatures. The data obtained during prior fast reactor development will play an important role in this area.

To meet these challenges, the R&D plan for the cladding and structural materials in the SCWRs focuses on acquiring data and a mechanistic understanding relating to the following key property needs: corrosion and SCC, radiolysis and water chemistry, dimensional and microstructural stability, and strength and creep resistance.

Corrosion and SCC. The SCWR corrosion and SCC research activities should focus on obtaining the following information:

- Corrosion rates in SCW at temperatures between 280 and 620°C (the corrosion should be measured under a wide range of oxygen and hydrogen contents to reflect the extremes in dissolved gasses)
- Composition and structure of the corrosion films as a function of temperature and dissolved gasses
- The effects of irradiation on corrosion as a function of dose, temperature, and water chemistry
- SCC as a function of temperature, dissolved gasses, and water chemistry
- The effects of irradiation on SCC as a function of dose, temperature, and water chemistry.

The corrosion and SCC R&D activities will be organized into three parts: an extensive series of out-of-pile corrosion and SCC experiments on unirradiated alloys, companion out-of-pile corrosion and SCC experiments on irradiated alloys, and in-pile loop corrosion and SCC tests. It is envisioned that at least two and maybe as many as four out-of-pile test loops would be used, some addressing the corrosion issues and others addressing the SCC issues. At least two such loops should be built inside a hot cell in order to study preirradiated material. Facilities to preirradiate samples prior to corrosion and SCC testing will be required. This work should be carried out over a 6–10 year time span for unirradiated materials and the same for irradiated materials. Accelerators capable of producing high currents of light ions may also be utilized to study irradiation effects on

corrosion and SCC in a postirradiation mode at substantially lower cost than reactor irradiations.

About mid-way through the out-of-pile work, one or two in-pile test loops, should start operating under both fast and thermal spectrum irradiation conditions (for a total of 3 to 4 loops). The in-pile loops will be used to study corrosion, SCC, and water chemistry control issues described below. About 10 years of in-pile testing in these loops will be needed to obtain all the required data to support both the viability and performance phases of the development of the thermal spectrum version of the SCWR, and about 15 years to obtain the needed information for the fast spectrum SCWR. A postirradiation characterization and analysis program will accompany the reactor- and accelerator-based irradiations beginning in year 5 and extending for a 10-year period.

Radiolysis and Water Chemistry. The SCWR water chemistry research program should focus on obtaining the following information:

- The complete radiolysis mechanism in SCW as a function of temperature and fluid density
- The chemical potential of H₂, O₂, and various radicals in SCW over a range of temperatures (280–620°C)
- Recombination rates of various radicals, H₂, and O₂ in SCW over a range of temperatures (280–620°C)
- Effect of radiation type: neutrons, gammas, as well as flux on radiolysis yields
- Formation and reaction of other species by radiolytic processes
- Impurities introduced into the primary system.

Two research avenues are envisioned to obtain this information. First, beam ports and accelerators can be used to irradiate SCW chemistries and study the characteristics of the recombination processes in some detail. This information will be integrated into a model of the water radiolysis mechanism. Second, water chemistry control studies can be performed using the in-pile test loops needed for the corrosion and SCC research discussed above.

Dimensional and Microstructural Stability. The SCWR dimensional and microstructural research activities should focus on obtaining the following information:

- Void nucleation and growth, and the effect of He production, on void stability and growth, and He

bubble nucleation and growth as a function of dose and temperature

- Development of the dislocation and precipitate microstructure and radiation-induced segregation as a function of dose and temperature
- Knowledge of irradiation growth or irradiation-induced distortion as a function of dose and temperature
- Knowledge of irradiation-induced stress relaxation as a function of tension, stress, material, and dose.

While many of the test specimens for this work will be irradiated in the corrosion and SCC in-pile loops discussed above, accelerator-based irradiation offers a rapid and low-cost alternative to the handling and analysis of neutron-irradiated material. Much of the needed information will be obtained during postirradiation examinations over the 15-year period of the corrosion and SCC tests. In addition, some stand-alone capsule irradiation tests in test reactors should be performed in order to timely obtain data on a range of candidate materials. It may be possible to utilize some existing SFR data in this research.

Strength, Embrittlement, and Creep Resistance. The SCWR strength, embrittlement, and creep resistance research activities should focus on obtaining the following information:

- Tensile properties as a function of dose and temperature
- Creep rates and creep rupture mechanisms as a function of stress, dose, and temperature
- Creep-fatigue as a function of loading frequency, dose, and temperature
- Time dependence of plasticity and high-temperature plasticity
- Fracture toughness as a function of irradiation temperature and dose
- Ductile-to-brittle transition temperature (DBTT) and helium embrittlement as a function of dose and irradiation temperature
- Changes in microstructure and mechanical properties following design basis accidents.

The research should aim at high-temperature performance of both irradiated and unirradiated alloys and also at low-temperature performance of irradiated alloys. High-temperature testing will include yield property determination, time dependent (creep) experiments, and

also the effect of fatigue loading with a high mean stress. This R&D should be conducted first on unirradiated alloys over a period of 8 years. Midway through the work, testing should begin on irradiated materials for a period of 10 years. The low-temperature fracture toughness/DBTT program will require 10 years.

SCWR Reactor Systems R&D

A number of reactor system alternatives have been developed for both vessel and pressure tube versions of the SCWR. Significant additional work in this area is not needed. The component development and proof testing is covered in the SCWR Design and Evaluation section.

SCWR Balance-of-Plant R&D

The SCWRs can utilize the existing technology from the secondary side of the supercritical water-cooled fossil-fired plants. Significant research in this area is not needed.

SCWR Safety R&D

An SCWR safety research activity is recommended, organized around the following topics:

- Reduced uncertainty in SCW transport properties
- Further development of appropriate fuel cladding to coolant heat transfer correlations for SCWRs under a range of fuel rod geometries
- SCW critical flow measurements, as well as models and correlations
- Measurement of integral loss-of-coolant accident (LOCA) thermal-hydraulic phenomena in SCWRs and related computer code validation
- Fuel rod cladding ballooning during LOCAs
- SCWR design optimization studies, including investigations to establish the reliability and system cost impacts of passive safety systems
- Power-flow stability assessments.

Transport Properties and Correlations

The purpose of making additional basic thermal-hydraulic property measurements at and near the pseudo-critical temperatures would be to improve the accuracy of the international steam-water property tables. This work could be done over a 3–5 year time frame.

The fuel cladding-to-SCW heat transfer research should consist of a variety of out-of-pile experiments starting with tubes and progressing to small and then relative

large bundles of fuel rods. The bundle tests should include some variations in geometry (such as fuel rod diameter and pitch, bundle length, channel boxes), axial power profiles, coolant velocity, pressure, and grid spacer design. The larger bundle tests will require several megawatts of power and the ability to design electrically heated test rods with appropriate power shapes. This program might take 5–6 years.

The SCW critical flow experiments would be out-of-pile experiments with variations in hole geometry and water inventory. This research would take 4–5 years.

LOCA Phenomena and Accident Analysis

The integral SCWR LOCA thermal-hydraulic experiments would be similar to the Semiscale experiments previously conducted for the U.S. Nuclear Regulatory Commission to investigate LOCA phenomena for the current LWRs. A test series and the related computer code development would take about 10 years. It may be possible to design this facility to accommodate the heat transfer research discussed above as well as the needed LOCA testing, and even some thermal-hydraulic instability testing.

Fuel rod cladding ballooning is an important phenomenon that may occur during a rapid depressurization. Although considerable work has been done to measure and model the ballooning of Zircaloy clad fuel rods during LOCAs, little is known about the ballooning behavior of austenitic or ferritic-martensitic stainless steel or nickel-based alloy clad fuel rods during a LOCA. It is expected that this information could be obtained from out-of-pile experiments using fuel rod simulators. The research would take 4–6 years.

All of the known accident scenarios must be carefully evaluated. These include large- and small-break LOCAs, reactivity insertion accidents (RIAs), loss of flow, main steam isolation valve closure, over cooling events, anticipated transients without scram, and high- and low-pressure boil off. There may be safety features (e.g., very-high-pressure accumulators) that require special designs. It is estimated that tests can be conducted within a period of 3–5 years.

Flow Stability

The objective of the power-flow stability R&D is better understanding of instability phenomena in SCWRs, identification of the important variables affecting these phenomena, and, ultimately, the generation of maps identifying the stable operating conditions of the different SCWRs designs. Consistent with the U.S. Nuclear

Regulatory Commission approach to BWRs licensing, the licensing of SCWRs will probably require, at a minimum, demonstration of the ability to predict the onset of instabilities. This can be done by means of a frequency-domain linear analysis.

Both analytical and experimental stability studies need to be carried out for the conditions expected during the different operational modes and accidents. The analytical studies can obviously be more extensive and cover both works in the frequency domain, as well as direct simulations. These studies can consider the effect of important variables such as axial and radial power profile, moderator density and fuel temperature reactivity feedback, fuel rod thermal characteristics, coolant channel hydraulic characteristics, heat transfer phenomena, and core boundary conditions. Mitigating effects such as orificing, insertion of control rods, and fuel modifications to obtain appropriate thermal and/or neutronic response time constants can also be assessed using analytical simulations. Instability experiments could be conducted at the multipurpose SCW thermal-hydraulic facility recommended for the safety experimentation discussed above. The test section should be designed to accommodate a single bundle, as well as multiple bundles. This will enable studying in-phase and out-of-phase density wave oscillations. Moreover, the facility will provide a natural circulation flow path for the coolant to study buoyancy loop instabilities. The instability experiments and related analytical work will require about 3 to 4 years. Further work would depend on the issues identified during the experimental program.

SCWR Design and Evaluation R&D

Many of the major systems that can potentially be used in a SCWR were developed for the current BWRs, PWRs, and SCW fossil plants. Therefore, the major plant design and development needs that are unique for SCWRs are primarily found in their design optimization, as well as their performance and reliability assurance under SCWR neutronic and thermo-hydraulic conditions. Two major differences in conditions are the stresses due to the high SCWR operating pressure (25 MPa) and the large coolant temperature and density change (approximately 280 to 500°C or more, 800 to 80 kg/m³, respectively) along the core under the radiation field.

Examples of design features that need to be optimized to achieve competitiveness in economics without sacrificing safety or reliability include the fuel assemblies, control rod drive system, internals, reactor vessel,

pressure relief values, coolant cleanup system, reactor control logic, turbine configuration, re-heaters, deaerator, start-up system and procedures, in-core sensors, and containment building. This work is expected to take about 8 to 10 years.

SCWR Fuel Cycle R&D

The thermal spectrum SCWR option will use conventional LEU fuel. The fuel itself is developed; however, new cladding materials and fuel bundle designs will be needed, as discussed in the Crosscutting Fuels and Materials R&D section. The designs for the thermal

spectrum SCWR will need significant additional moderator, i.e., water rods or solid moderation. The designs for the fast spectrum SCWRs will require a tight pitch, but high neutron leakage to create a negative density coefficient. The fast spectrum SCWR option uses mixed plutonium-uranium oxide fuel with advanced aqueous reprocessing. These fuel cycle technologies are discussed in the Crosscutting Fuel Cycle R&D section.

SCWR R&D Schedule and Costs

A schedule for the SCWR R&D is shown below, along with the R&D costs and decision points.

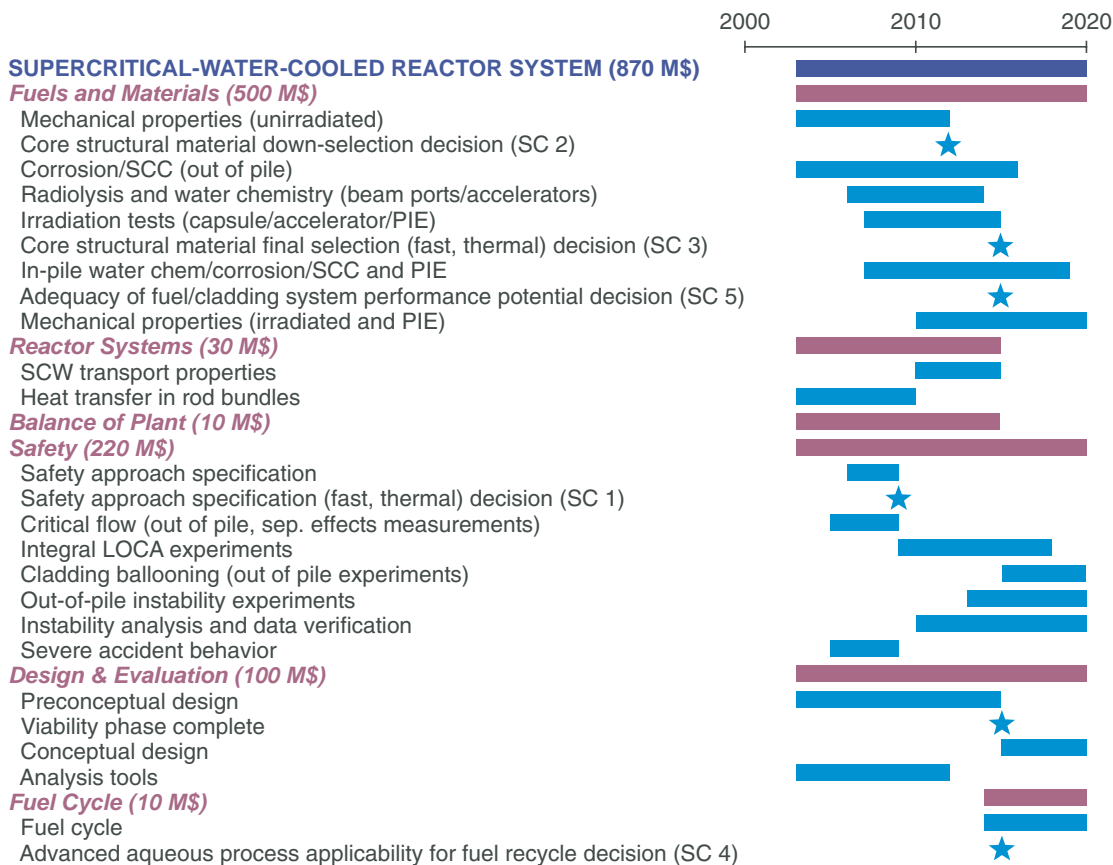

Very-High-Temperature Reactor System R&D

VHTR Description

The VHTR is a next step in the evolutionary development of high-temperature gas-cooled reactors. The VHTR can produce hydrogen from only heat and water by using thermochemical iodine-sulfur (I-S) process or from heat, water, and natural gas by applying the steam reformer technology to core outlet temperatures greater than about 1000°C. A reference VHTR system that produces hydrogen is shown below. A 600 MWth VHTR dedicated to hydrogen production can yield over 2 million normal cubic meters per day. The VHTR can also generate electricity with high efficiency, over 50% at 1000°C, compared with 47% at 850°C in the GT-MHR or PBMR. Co-generation of heat and power makes the VHTR an attractive heat source for large industrial complexes. The VHTR can be deployed in refineries and petrochemical industries to substitute large amounts

of process heat at different temperatures, including hydrogen generation for upgrading heavy and sour crude oil. Core outlet temperatures higher than 1000°C would enable nuclear heat application to such processes as steel, aluminum oxide, and aluminum production.

The VHTR is a graphite-moderated, helium-cooled reactor with thermal neutron spectrum. It can supply nuclear heat with core-outlet temperatures of 1000°C. The reactor core type of the VHTR can be a prismatic block core such as the operating Japanese HTTR, or a pebble-bed core such as the Chinese HTR-10. For electricity generation, the helium gas turbine system can be directly set in the primary coolant loop, which is called a *direct cycle*. For nuclear heat applications such as process heat for refineries, petrochemistry, metallurgy, and hydrogen production, the heat application process is generally coupled with the reactor through an intermediate heat exchanger (IHX), which is called an *indirect cycle*.

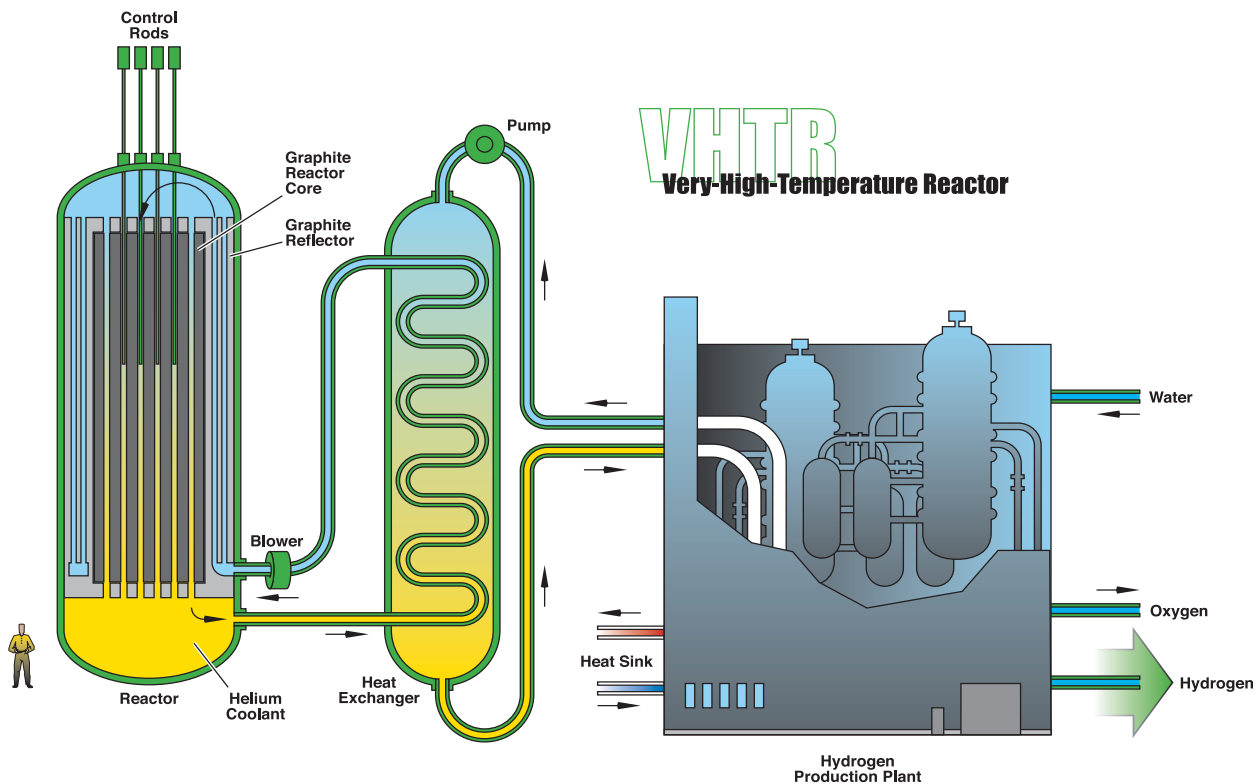

02-GA50807-01

Technology Base for the VHTR

The VHTR evolves from HTGR experience and extensive international databases that can support its development. The basic technology for the VHTR has been well established in former HTGR plants, such as Dragon, Peach Bottom, AVR, THTR, and Fort St Vrain and is being advanced in concepts such as the GT-MHR and PBMR. The ongoing 30-MWth HTTR project in Japan is intended to demonstrate the feasibility of reaching outlet temperatures up to 950°C coupled to a heat utilization process, and the HTR-10 in China will demonstrate electricity and co-generation at a power level of 10 MWth. The former projects in Germany and Japan provide data relevant to VHTR development.

Steam reforming is the current hydrogen production technology. The coupling of this technology will be demonstrated in large scale in the HTTR program but still needs complementary R&D for market introduction. R&D on thermochemical I-S process is presently proceeding in the laboratory-scale stage.

Technology Gaps for the VHTR

The design parameters considered for the VHTR are shown in the table.

Reactor Parameters	Reference Value
Reactor power	600 MWth
Coolant inlet/outlet temperature	640/1000°C
Core inlet/outlet pressure	Dependent on process
Helium mass flow rate	320 kg/s
Average power density	6–10 MWth/m ³
Reference fuel compound	ZrC-coated particles in blocks, pins or pebbles
Net plant efficiency	>50%

Demonstrating the viability of the VHTR core requires meeting a number of significant technical challenges. Novel fuels and materials must be developed that:

- Permit increasing the core-outlet temperatures from 850°C to 1000°C and preferably even higher
- Permit the maximum fuel temperature reached following accidents to reach 1800°C
- Permit maximum fuel burnup of 150–200 GWD/MTHM
- Avoid power peaking and temperature gradients in the core, as well as hot streaks in the coolant gas.

Process-specific R&D gaps exist to adapt the chemical process and the nuclear heat source to each other with regard to temperatures, power levels, and operational pressures. Heating of chemical reactors by helium is different from current industrial practice and needs specific R&D and demonstration. Qualification of high-temperature alloys and coatings for resistance to corrosive gases like hydrogen, carbon monoxide, and methane will be needed.

The viability of producing hydrogen using the iodine-sulfur (I-S) process still requires pilot- and large-scale demonstration of the three basic chemical reactions and development of corrosion-resistant materials. Any contamination of the product will have to be avoided. Development of heat exchangers, coolant gas ducts, and valves will be necessary for isolation of the nuclear island from the production facilities. This is especially the case for isotopes like tritium, which can easily permeate metallic barriers at high temperatures.

Performance issues for the VHTR include development of a high-performance helium turbine for efficient generation of electricity. Modularization of the reactor and heat utilization systems is another challenge for commercial deployment of the VHTR.

VHTR Fuels and Materials R&D

Qualification of TRISO Fuel. The increase of the helium core-outlet temperature of the VHTR results in an increase of the fuel temperature and reduced margins in case of core heatup accidents. Fuel particles coated with silicon-carbide are used in HTGRs at fuel temperatures of about 1200°C. Irradiation testing is required to demonstrate that TRISO-coated particles can perform acceptably at the high burnup and temperature associated with the VHTR. Following irradiation, high-temperature heating (safety) tests are needed to determine that there is no degradation in fuel performance under accident heatup conditions up to 1600°C as a result of the more demanding irradiation service conditions. These fuel demonstration activities would require about 5 to 7 years to complete following fabrication of samples. Complete fuel qualification would require an additional 5 to 7 years in which statistically significant production scale fuel is irradiated to confirm the performance of the fuel from the production facility. Irradiation facilities and safety test facility exist worldwide, and an integrated coordinated fuel development program could shorten development times by one-third.

ZrC Coatings for TRISO Fuel. Above a fuel temperature of 1200°C, new coating materials such as zirconium-carbide and/or improved coating techniques should

be considered. Use of ZrC in HTGRs enables an increase in power density and an increase in power size under the same coolant outlet temperature and allows for greater resistance against chemical attack by the fission product palladium. The limited fabrication and performance data on ZrC indicates that although it is more difficult to fabricate, it could allow for substantially increased operating and safety envelopes (possibly approaching 1800°C). Only laboratory-scale fabrication of ZrC-coated particle fuel has been performed to date. Research into more economical commercial-scale fabrication routes for ZrC-coated particle fuels, including process development at production scale, is required. Advanced coating techniques or advanced processing techniques (automation) should be considered. Process development on production-scale coating is required. Irradiation testing and high-temperature heating (safety) tests are needed to define operation and safety envelopes/limits for this fuel, with the goal of high burnup (>10% FIMA and high-temperature (1300–1400°C) operation. The facilities used for TRISO-coated particle testing can also be used for ZrC-coated fuel development. These activities would require 10 to 15 years to complete and could be performed at facilities adapted from those available around the world currently used for SiC-based coated particle fuel.

Burnable Absorbers. Increasing the allowable fuel burnup requires development of burnable absorbers for reactivity control. The behavior of burnable absorbers needs to be established (e.g., irradiation dimensional stability, swelling, lifetime) under the design service conditions of the VHTR.

Carbon-Carbon Composite Components. Development of carbon-carbon composites is needed for control rod sheaths, especially for the VHTR based on a prismatic block core, so that the control rods can be inserted to the high-temperature areas entirely down to the core. Promising ceramics such as fiber-reinforced ceramics, sintered alpha silicon-carbide, oxide-composite ceramics, and other compound materials are also being developed for other industrial applications needing high-strength, high-temperature materials. Planned R&D includes testing of mechanical and thermal properties, fracture behavior, and oxidation; post irradiation heat-up tests; and development of models of material behavior and stress analysis code cases considering anisotropy. The feasibility of using superplastic ceramics in VHTR components will be investigated by studying the effects of neutron irradiation on superplastic deformation mechanisms. Testing of core internals is envisioned to take 5 to 10 years at any of the test reactors worldwide.

Pressure Vessel Materials. To realize the goal of core outlet temperatures higher than 1000°C, new metallic alloys for reactor pressure vessels have to be developed. At these core-outlet temperatures, the reactor pressure vessel temperature will exceed 450°C. LWR pressure vessels were developed for 300°C service, and the HTTR vessel for 400°C. Hasteloy-XR metallic materials are used for intermediate heat exchanger and high-temperature gas ducts in the HTTR at core-outlet temperatures up to about 950°C, but further development of Ni-Cr-W super-alloys and other promising metallic alloys will be required for the VHTR. The irradiation behavior of these superalloys at the service conditions expected in the VHTR will need to be characterized. Such work is expected to take 8 to 12 years and can be performed at facilities available worldwide.

An alternate pressure vessel allowing for larger diameters and ease of transportation, construction, and dismantling would be the prestressed cast-iron vessel, which can also prevent a sudden burst due to separation of mechanical strength and leak tightness. The vessel could also include a passive decay heat removal system with enhanced efficiency.

Heat Utilization Systems Materials. Internal core structures and cooling systems, such as intermediate heat exchanger, hot gas duct, process components, and isolation valve that are in contact with the hot helium can use the current metallic materials up to about 1000°C core-outlet temperature. For core-outlet temperatures exceeding 1000°C, ceramic materials must be developed. Piping and component insulation also requires design and materials development.

VHTR Reactor Systems R&D

Core Internals. Core internal structures containing the fuel elements such as pebbles or blocks are made of high-quality graphite. The performance of high-quality graphite for core internals has been demonstrated in gas-cooled pilot and demonstration plants, but recent improvements in the manufacturing process of industrial graphite have shown improved oxidation resistance and better structural strength. Irradiation tests are needed to qualify components using advanced graphite or composites to the fast fluence limits of the VHTR.

VHTR Balance-of-Plant R&D

The VHTR balance-of-plant is determined by the specific application, which can be thermochemical processes, dedicated electricity production or cogeneration. All components have to be developed for temperatures well above the present state of the art and depend

on a comprehensive material qualification activity. Failure mechanisms such as creep, fretting, and ratcheting have to be studied in detail, precluded with design, and demonstrated in component tests. Specific components such as IHX, isolation valves, hot gas ducts with low heat loss, steam reformers, and process-related heat exchangers have to be developed for use in the modular VHTR, which mainly uses only one loop. This leads to much larger components than formerly developed and a new design approach by modularization of the component itself.

Low pressures are necessary or preferable for many processes. Alternate coolants for the intermediate loop such as molten salt should be adapted where needed.

Process-specific components will need to be tested. Other applications will require different components such as helium-heated steam crackers, distiller columns, and superheaters.

I-S Process Subsystem. The development and qualification of an I-S process subsystem is needed. This is discussed in the Crosscutting Energy Products R&D section.

Analysis Methods. Extension and validation of existing engineering and safety analysis methods is required to include new materials, operating regimes, and component configurations in the models. New models need to be developed for the VHTR with balance of plant consisting of thermochemical process and other energy applications.

VHTR Safety R&D

Passive heat removal systems should be developed to facilitate operation of the VHTR, with a final goal of simple operation and transparent safety concepts. Demonstration tests should be performed on the VHTR to verify the system's passive characteristics, which have a lower margin between operational temperatures and the limits for fuel and materials.

Analysis and demonstration of the inherent safety features of the VHTR are needed, and could potentially draw on development and demonstration of earlier INTD gas reactors. Additional safety analysis is necessary with regard to nuclear process heat applications in an industrial environment. The safe isolation of the reactor

system after failures in the heat delivery system is an essential issue for demonstration of IHX and hot gas valve tightness after depressurization of the secondary circuit. Full-scale tests of valves and IHX modules will be necessary.

Design basis and severe accident analyses for the VHTR will need to include phenomena such as chemical attack of graphitic core materials, typically either by air or water ingress. Adequacy of existing models will need to be assessed, and new models, may need to be developed and validated.

VHTR Fuel Cycle R&D

Disposal of Once-Through Fuel and Graphite. The VHTR assumes a once-through, LEU (<20% ²³⁵U) fuel cycle. Like LWR spent fuel, VHTR spent fuel could be disposed of in a geologic repository or conditioned for optimum waste disposal. The current HTGR particle fuel coatings form an encapsulation for the spent fuel fission products that is extremely resistant to leaching in a final repository. However, as removed from the reactor, the fuel includes large quantities of graphite, and research is required to define the optimum packaging form of spent VHTR fuels for long-term disposal. Radiation damage will require graphite replacement every 4 to 10 years. An optimized approach for dealing with the graphite (i.e., recycle, low-level waste, remain integral with spent fuel) remains to be defined.

Fuel Recycling. Recycling of LWR and VHTR spent fuel in a symbiotic fuel cycle can achieve significant reductions in waste quantities and radiotoxicity because of the VHTR's ability to accommodate a wide variety of mixtures of fissile and fertile materials without significant modification of the core design. This flexibility was demonstrated in the AVR test reactor in Germany and is a result of the ability of gas reactors to decouple the optimization of the core cooling geometry from the neutronics.

For an actinide burning alternative, specific Pu-based driver fuel and transmutation fuel containing minor actinides would have to be developed. This fuel can benefit from the above mentioned R&D on SiC and ZrC coating but will need more R&D than LEU fuel.

VHTR R&D Schedule and Costs

A schedule for the VHTR R&D is shown below, along with the R&D costs and decision points.

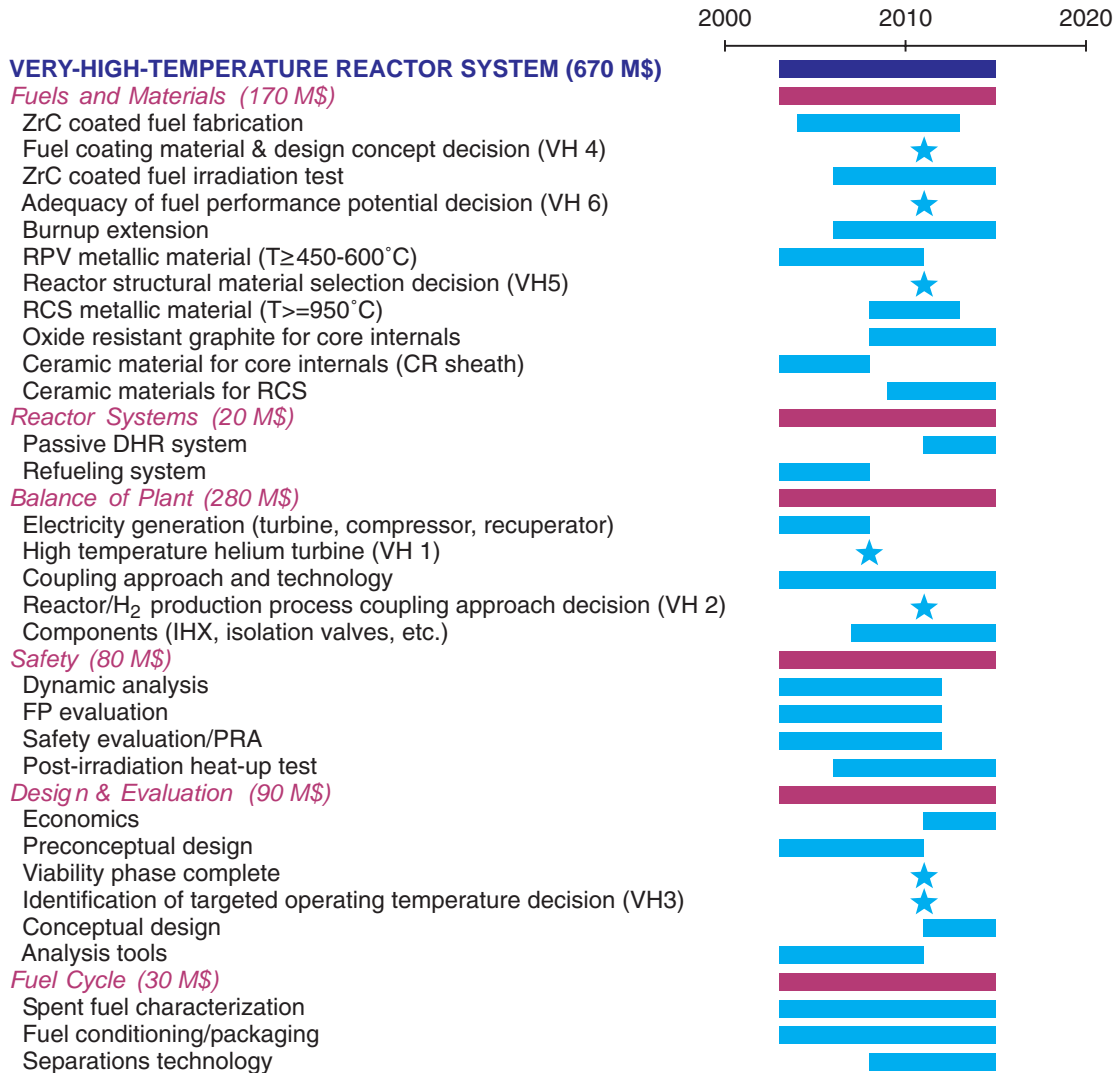

RECOMMENDED CROSSCUTTING R&D

The crosscutting R&D is organized into the following areas:

- Fuel cycle
- Fuels and materials
- Energy products
- Risk and safety
- Economics
- Proliferation Resistance and Physical Protection.

Crosscutting Fuel Cycle R&D

Introduction and Approach

A number of options for fuel and recycle technology development are shared among the six Generation IV systems. The table below provides an overview of these systems, indicating primary and secondary technology options. While this table is organized into four major fuel categories and two recycle technologies, it is important to note that a tight coupling exists in any given system between its reactor, fuel, and recycling technology. These technologies are specialized to a particular system through studies and experiments aimed at optimizing a given system.

The crosscutting fuel cycle R&D is structured recognizing the close coupling of fuel and recycle technologies for a given system, but also the value of common technology development for Generation IV systems. In particular:

- Fuel choice and in-service performance are closely coupled to, and require specialization for, each system. Therefore, fuel development R&D is defined for each Generation IV system individually. Relevant developments for different Generation IV systems will be shared, and effective ways to adapt technologies will be sought.
- Fuel recycle technology R&D requires substantial investment in specialized facilities, so shared development of recycle technologies and common test facilities are desirable. Recycle technology R&D is outlined primarily in terms of the SFR system, which is at a comparatively advanced state of development for both of its selected options (i.e., oxide fuel with advanced aqueous recycle, and metal-alloy fuel with pyroprocess recycle). Adaptation of the SFR advanced aqueous and pyroprocessing technologies to other Generation IV systems (e.g., to nitride fuel for the LFR system, or

Generation IV System	Fuel				Recycle	
	Oxide	Metal	Nitride	Carbide	Advanced Aqueous	Pyroprocess
GFR ¹			S	P	P	P
MSR ²						
SFR ³	P	P			P	P
LFR		S	P		P	P
SCWR	P				P	
VHTR ⁴	P				S	S

P: Primary option; S: Secondary option

¹ The GFR proposes (U,Pu)C in ceramic-ceramic (cercer), coated particles or ceramic-metallic (cermet).

² The MSR employs a molten fluoride salt fuel and coolant, and fluoride-based processes for recycle.

³ The SFR has two options: oxide fuel with advanced aqueous, and metal fuel with pyroprocess.

⁴ The VHTR uses a once-through fuel cycle with coated (UCO) fuel kernels, and no need for fuel treatment, as the primary option.

to composite fuels for the GFR) will explore key viability questions at an early stage. These specializations are presented as system-specific R&D in their respective sections.

In addition to fuel recycle technology development, crosscutting fuel cycle R&D recommendations are made to (1) improve the technical and cost performance achieved in Generation IV fuel cycles, and (2) better inform the selection of integrated Generation IV fuel cycles by clarifying the advantages and drawbacks of technology alternatives and defining the best directions along which to proceed. These recommendations are described in the Additional Crosscutting R&D section below.

The recycle technology R&D addressing advanced aqueous and pyroprocess technology for the SFR is presented next.

Recycle Technology R&D

The objective of this R&D is to complete the process development required to initiate the design of commercial fuel cycle facilities for both oxide and metal fuels of the SFR. The scales of commercial oxide and metal facilities are different. An oxide treatment facility would likely be centralized with throughput on the order of about 1000 MTHM per year for LWR fuel, or about 100 MTHM per year for fast reactor fuel. Collocation of the fuel cycle facility and the reactor plant is not excluded however. A metal fuel cycle facility would likely be located with a fast reactor and have a throughput on the order of 5 MTHM per year.

Advanced Aqueous Process and Remote Ceramic Fuel Fabrication. Advanced aqueous reprocessing and advanced pelletizing are the preferred recycle technologies for the MOX-fueled SFR option. Advanced aqueous technology is also a viable option for processing LWR spent fuel, enabling the production of initial core loads for fast reactors.

The advanced aqueous reprocessing option consists of a simplified PUREX process with the addition of a uranium crystallization step and a minor actinide recovery process. A schematic of a closed fuel cycle with advanced aqueous technology is shown in the figure on the following page. The purification process of U and Pu in the conventional PUREX is eliminated, and U/Pu is co-extracted with Np with reasonable decontamination factors (DFs) for recycle use. The uranium crystallization removes most of the bulk heavy metal at the head end and eliminates it from downstream processing. The main process stream is salt-free, which

reduces the low-level waste. The advanced pelletizing process is simplified by eliminating the powder blending and granulation steps from the conventional MOX pellet process.

In the oxide fuel cycle, greater than 99% of U/TRU is expected to be recycled, and the decontamination factor of the reprocessing product is higher than 100. Few viability R&D activities are needed, because the main process technology builds heavily on prior light water and fast reactor fuel cycle technology. Therefore, this fuel cycle can be rapidly advanced to the demonstration stage.

To achieve both economic competitiveness and reduced environmental impact, the following R&D is recommended:

- Determine the crystallization performance of actinides, the crystallization performance of uranium, and the separation efficiency of solids at engineering scale
- Develop the salt-free minor actinide recovery process with high extraction capability for Am and Cm, and separation from lanthanides
- Develop compact centrifugal-type contactors to enable a reduction of the facility size
- Establish the fabricability of low- decontamination factor minor actinide-bearing pellet fuel (with an emphasis on sinterability), and develop the apparatus for remote system operability and maintainability in a hot cell facility
- Extend current studies of the proliferation resistance of this technology.

Pyroprocess and Remote Metal Fuel Fabrication.

Pyroprocessing and refabrication are the preferred recycle technologies for the metal-fueled SFR option. A schematic of a closed fuel cycle with pyroprocessing technology is shown in the figure on page 56.

Pyroprocessing employs molten salts and liquid metals for treatment, management, and recycle of spent fuel. It can recycle metallic fuel from fast reactors, and with appropriate head end steps to reduce actinide oxides to metals, it can process existing LWR fuel to recover transuranics for feed to fast reactors. These two uses have many common characteristics and process steps.

Work on the pyroprocessing fuel cycle has been performed in the United States, Japan, and Europe. A significant portion of the viability R&D and some performance R&D have already been performed as part of the ongoing EBR-II fuel treatment program in the

United States. However, two process steps and high-level waste volume reduction options have not been pursued beyond laboratory-scale testing. Further, the recovery fraction of the pyroprocess needs to be increased. These are the focus of R&D for the pyroprocess option.

The first needed process step is reduction of actinide oxides to metal. Laboratory-scale tests have been performed to demonstrate process chemistry, but additional work is needed to progress to the engineering scale. The second needed step is to develop recovery processes for transuranics, including plutonium. With regard to volume reduction, additional process R&D

could potentially increase fission product loadings in the high-level waste and reduce total waste volumes.

With regard to achieving the high recovery of transuranics, pyroprocessing has been developed to an engineering scale only for the recovery of uranium. Recovery of all transuranics, including neptunium, americium, and curium, has so far been demonstrated at laboratory scale. Viability phase R&D is recommended to verify that all actinides can be recycled with low losses.

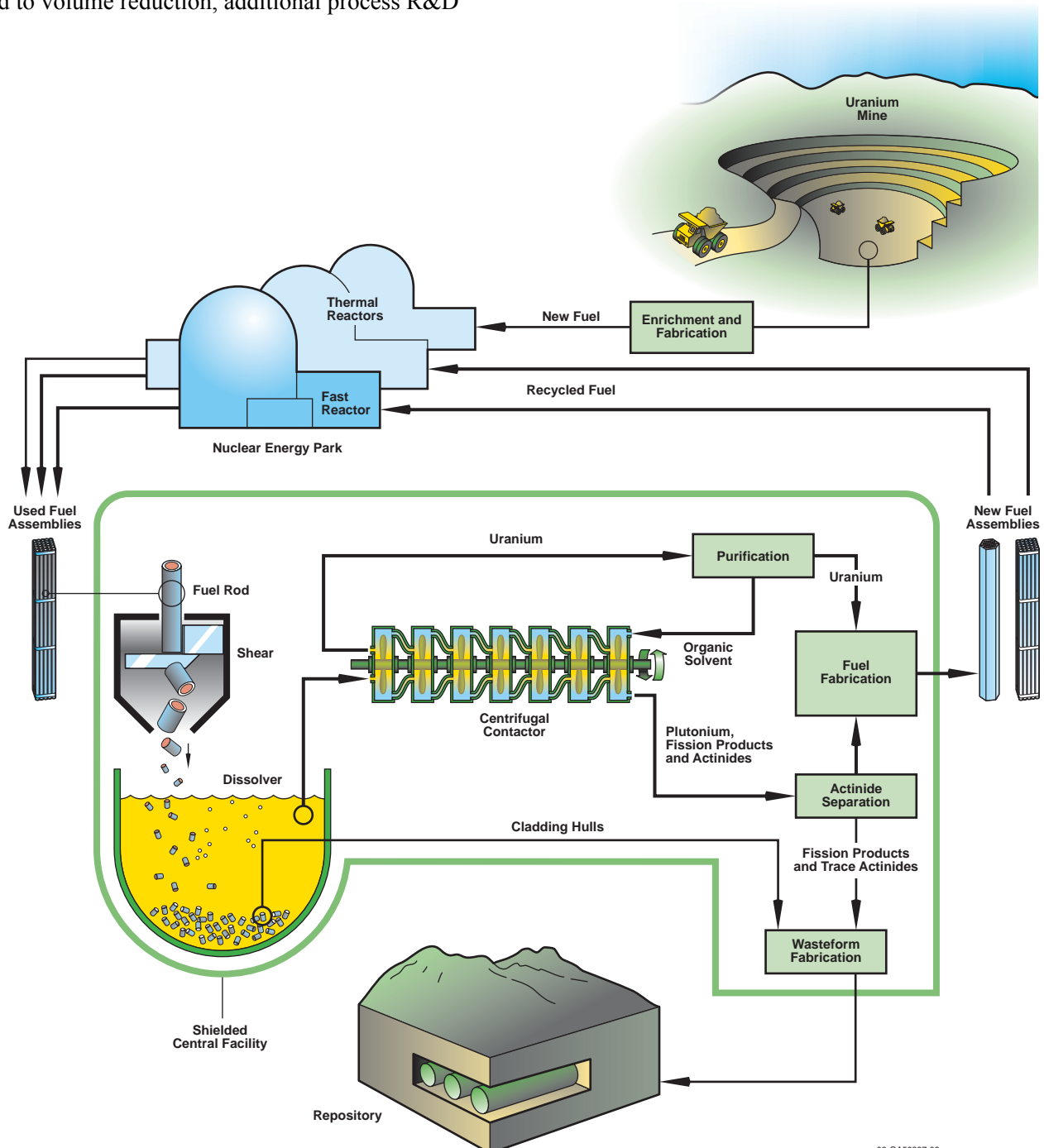

02-GA50807-08

Adaptations for Other Systems and Fuels

The above processes, aimed primarily at the oxide and metal fuels of the SFR, will be evaluated and adapted for application to other Generation IV systems. This is primarily an issue at the head end of the process (where, e.g., fuels from the GFR or LFR systems would be converted to oxide or metal and introduced into the processes described above), and at the tail end (where

they would be reconverted to fuel feedstock). Feasibility evaluations and bench-scale testing would enable comparisons to be made between the advanced aqueous and pyroprocess options. Specific issues are presented with the individual systems.

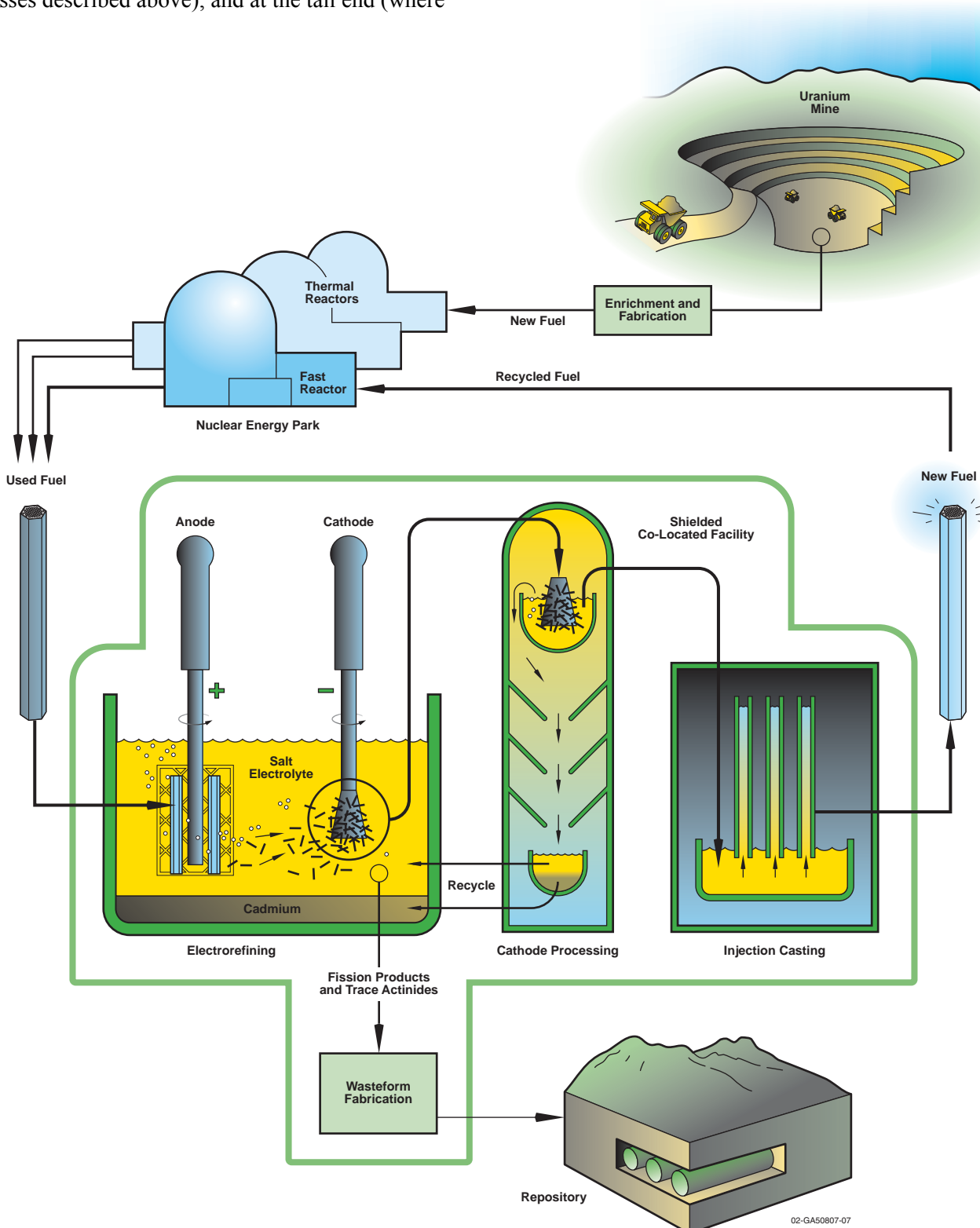

Alternative Process Development

Uranium Extraction in Aqueous Processing. The principal aim of the uranium crystallization process step in advanced aqueous reprocessing is the inexpensive separation of bulk quantities of low-enriched uranium from spent fuel from LWRs. The motivation for this approach is clear: separating the bulk uranium yields an LWR spent fuel process stream that is reduced in heavy metal content by two orders of magnitude, which offers significant potential for volume and cost reduction. The uranium crystallization technique is the favored technology in Japan, and it shows considerable promise. Other means of removing the uranium component of spent LWR fuel are being explored internationally. Principal among these is the uranium extraction (UREX) process, which is under development in the United States. In UREX, uranium is extracted in a first step of advanced aqueous processing technology, and the plutonium, minor actinides and nonvolatile fission products are sent to the next process step. The relative advantages and disadvantages of uranium crystallization and UREX should be established through R&D activities for international comparison and development.

Other Dry Processes and Vibropac Fabrication.

Alternative nonaqueous, i.e., *dry* fuel cycle processes have been investigated in Russia and more recently in Japan. Examples are fluoride volatility and AIROX. These methods also aim to establish remote fuel refabrication methods that eliminate the need for remotely operable and maintainable ceramic pellet fabrication production lines through vibratory compaction or *vibropac*. An R&D activity is recommended to better develop these alternatives.

Additional Crosscutting R&D

The fuel cycle preferred for most of the Generation IV systems is a full actinide recycle fuel cycle, where plutonium and all minor actinides are recycled. This includes recycling in symbiotic cycles for management of spent fuel from current and near-term systems. Recycle of all actinides promises to:

- Reduce long-term waste toxicity source term sent to a geologic repository
- Minimize emplacement of nuclear materials suitable for weapons use in the repository
- Increase repository capacity by reducing long-term decay-heat generation and emplacement
- Improve repository performance by reducing radiation damage on the final waste forms.

Two alternatives for recycling the minor actinides from spent fuel may be considered: (1) *heterogeneous* recycle, in which most of the minor actinides are separated from plutonium and incorporated into new fuel for reactor irradiation, or (2) *homogeneous* recycle, in which the minor actinides and plutonium extracted from spent fuel are incorporated together into new fuel. In either case, a fast spectrum reactor (or a liquid fueled reactor such as the MSR) is required to consume the minor actinides, during subsequent irradiation. Thermal reactors can be used to consume plutonium in the case of heterogeneous recycle. Achieving viability of full actinide recycle requires an integrated approach for managing minor actinides, which is optimized with respect to the choice of recycle, refabrication method, and reactor system.

Two specific viability phase R&D activities are recommended to help decide the best path for developing full actinide recycle in the performance phase:

Extractant Development. One of the technology gaps for full actinide recycle is the initial segregation of uranium contained in the LWR spent fuel from the transuranics and fission products that are to be further processed and recycled. Crystallization and lithium reduction are the reference options for accomplishing this, and UREX is an alternate technology under development in the United States.

R&D is recommended to search for a new extraction agent that could extract the uranium from spent nuclear fuel (SNF), leaving the transuranics and fission products for further processing and recycle. If such an extractant could be found, it may offer considerable simplification and cost advantages.

After the uranium is segregated from the transuranics and fission products of the LWR spent fuel, then the transuranics must be separated from fission products and refabricated for recycle. Current aqueous processing approaches use a sequence of different processes to extract each transuranic element one at a time. R&D is recommended to search for new aqueous extraction agents that could remove the Np, Pu, Am, and Cm transuranics from an aqueous stream in a single step. If this could be achieved, full actinide recycle cost, accident risk, proliferation vulnerability, and development requirements may be dramatically reduced for aqueous processes.

Homogeneous versus Heterogeneous Recycle of Minor Actinides. Homogeneous and heterogeneous recycle are introduced in an earlier section.

Heterogeneous recycle offers additional flexibility of the treatment of the streams, yet segregated minor actinide refabrication and recycle would entail handling of the highly radioactive minor actinides undiluted by plutonium. R&D during the viability phase is recommended to evaluate the technological and cost implications of heterogeneous minor actinide recycle using curium as the example. Curium is a difficult actinide to recycle because it produces the highest decay heat and neutron source per unit mass, and it has a very small critical mass, which restricts the process batch size. This recommended crosscutting R&D activity seeks to quantify important aspects of the tradeoffs between heterogeneous and homogeneous minor actinide management for the case of full-actinide recycle.

Cesium and Strontium Heat Management. For the first 50 to 100 years after SNF is discharged from a reactor, the cesium and strontium are the primary sources of decay heat, the strontium is the primary ingestion hazard, and the cesium is the primary gamma source. These two fission products decay away with about a 30-year half life. If these radionuclides, which are destined ultimately for geologic disposal, were processed and managed separately, several benefits could accrue:

- A given repository capacity might be increased, because capacity is primarily determined by heat load, and delay in emplacing the main short-term heat source would increase capacity
- Radiation shielding of some process operations, waste transport, and waste disposal would decrease
- A significant short-term hazard from strontium would not enter the repository waste stream.

Because of the limited lifetime of cesium and strontium (except ^{135}Cs) and given their high importance to heat loading, inexpensive methods may be developed to handle these wastes at the fuel cycle back end.

Many alternatives exist for heat management in once-through and recycle fuel cycles. For once-through, interim storage and interim active repository cooling are options. For recycle, the waste forms that contain Cs/Sr could be held in interim storage before repository emplacement or dual repository designs; one for low heat and one for high heat waste forms could be considered. R&D activities are recommended to address scientific, engineering, and geological disposal issues

and institutional requirements for the management of separated Cs and Sr, to analyze the costs and benefits, and to determine the preferred decay heat management options.

Integrated Once-Through Fuel Cycles. In the early years of the nuclear power industry, it was thought that uranium was a scarce resource. The reactors and fuel cycle were developed with the assumption that SNF would be rapidly processed for recovery of plutonium and uranium, and the operations at the back end of the fuel cycle, including repository designs, considered that only high-level waste would be disposed of. This assumption later reversed as many countries changed to a once-through fuel cycle, but some of the back end operations remained unchanged. If one were to redesign the once-through fuel cycle, it might be significantly different than the current practice. Further, some of the Generation IV systems are once-through, which could benefit from R&D into new approaches.

For a redesigned once-through fuel cycle, the desired characteristics are as follows:

- Reduced handling of SNF to reduce cost and risks, and improve security and safeguards
- Reduced storage of SNF in reactor pools with enhanced physical security and reduced capital costs for spent fuel storage in reactors
- Earlier placement of SNF in geological repositories
- Repositories that would allow easy recovery of SNF if conditions were to change. This is termed an *open future* repository; safe disposal is assured and commitments by future generations to ensure safe SNF disposal are minimized, while at the same time society retains an option to retrieve and recycle the SNF if conditions change.

Recent technical developments suggest that once-through systems with such characteristics are possible and may be more economical than the current system. An element of such a system is a multipurpose self-shielded cask loaded at the reactor with SNF and never reopened. The cask is used for storage, transport, and disposal but uses different overpacks during storage versus during disposal—to meet the differing requirements of storage of SNF after short cooling times versus long-term disposal. The repository is modified to allow early placement of SNF.

Some, but not all, of the technology is in existence for such a system. R&D is recommended to establish the viability of key technologies: (1) controlling spent fuel

temperatures in large casks with short-cooled spent fuel, (2) components meeting requirements for storage, transport, and disposal, including restrictions on choice of materials allowed in a repository, (3) behavior of spent fuel over long periods of time inside a cask, and (4) repository designs that allow placement of shorter-cooled spent fuel without adversely impacting repository capacity. The repository becomes a managed facility for a period of time during which it has the characteristics of a combined storage and disposal facility.

Sustainability Evaluation Methodology. Quantitative metrics were developed during the roadmap for fuel utilization and waste minimization, but not for environmental impacts of the fuel cycle. For fuel utilization and waste minimization, objective formulas were derived

and can remain the basis for evaluation. In the case of environmental impacts, the methodology that exists for the preparation of preliminary environmental impact statements can be adapted for evaluations. Therefore, in principle no further development of evaluation methods is identified in sustainability. However, noting that a number of countries define sustainability in broader terms, additional R&D to develop methodology for these broader frameworks may be desirable for individual countries.

Crosscutting Fuel Cycle R&D Schedule and Costs

A schedule for the crosscutting fuel cycle R&D is shown below, along with the R&D costs and decision points.

FUEL CYCLE CROSSCUT (230 M\$)

Advanced Aqueous (70 M\$)

- Head end process
- UNH crystallization technology
- Minor actinide recovery technology
- Adequacy of actinide recovery fraction (Adv. Aqueous) decision (FC 1)
- Main equipment design
- High level and TRU waste reduction

Pyroprocess (100 M\$)

- Process materials selection
- Oxide SNF reduction (including head end)
- Applicability of pyro-recycle to LWR spent fuel decision (FC 2)
- Electro-refiner development
- Refabrication process
- Process waste reduction
- Adequacy of actinide recovery (pyroprocessing) decision (FC 3)
- Waste form development and qualification
- Material control and accountability

Alternative Process Development (10 M\$)

Aqueous Group Extractant Development (10 M\$)

- Extractant molecule design campaign
- Surrogate bench testing
- Hot cell testing
- Feasibility of group extraction of actinides in aqueous process decision (FC 6)

Systems Evaluation of Homogeneous vs. Heterogeneous Recycle (10 M\$)

- Full-scope life cycle evaluation of Cm management strategies
- Cm target fabrication option study screening and option selection
- Hot cell testing

Cs/Sr Management Strategy (10 M\$)

- Systems study near-term heat management options and effects
- Recommendation on separate management of Cs, Sr decision (FC 4)

Integrated Once-Through Fuel Cycles (10 M\$)

- System study once-through open-future integrated fuel cycles
- Approach for integrated management of once-through cycle decision (FC 5)
- Design option trade study for variable heat removal cask design
- Design option trade study of ventilated repository concepts

Sustainability Evaluation Methodology (10 M\$)

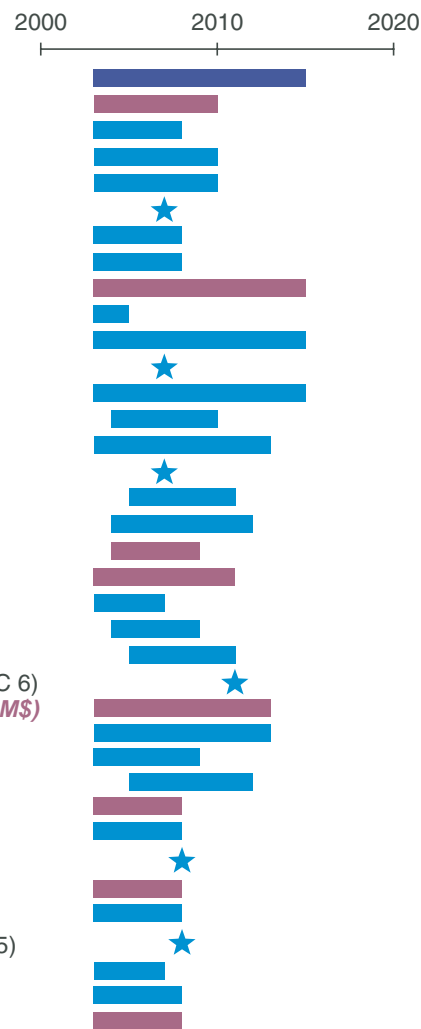

Crosscutting Fuels and Materials R&D

Introduction and Approach

This section addresses crosscutting R&D on fuels and materials. To introduce this area, a few observations are first established:

- All Generation IV systems project in-service and off-normal temperatures that are beyond current nuclear industry experience, as well as most previous experience with developmental systems. All require relatively long service lifetimes for materials and relatively high burnup capability for fuels.
- Most systems call for use of fast and epithermal neutron spectra, which will challenge materials performance with increased radiation damage.
- Even for systems with different coolants, many applications have important similarities, such as temperature, stress, and neutron spectra. This suggests the opportunity to survey similar materials, or classes of materials, for use in Generation IV systems. The following table indicates classes of materials proposed for the systems.

Candidate Materials

Fuels and materials that meet the requirements of Generation IV systems must be identified, and databases sufficient to support design and licensing must be established. Some applications are similar to nonnuclear applications, which can provide a basis for identifying candidate materials. A summary of the fuels and materials options considered for each of the systems is provided in the table on the next page. The table reflects initial suggestions based on experience, but for many applications few data are available to support the recommendation of a specific alloy or material.

The lack of data for the proposed materials suggests that a broad-based materials R&D program will serve the initial development of the systems. The proposed R&D activities will provide information and property data that pertain to multiple Generation IV systems. These activities should be crosscutting early in the research, but are expected to become more system specific as the systems are developed. A broad selection of data needs should be considered, such as measurements of nuclear data to support the systems design and safety analysis.

System	Fuel Materials					Structural Materials						
	Oxide	Metal	Nitride	Carbide	Fluoride (liquid)	Ferritic-martensitic Stainless Steel Alloys	Austenitic Stainless Steel Alloys	Oxide Dispersion Strengthened	Ni-based Alloys	Graphite	Refractory Alloys	Ceramics
GFR			S	P		P	P	P	P		P	P
MSR					P				P	P	S	S
SFR	P	P				P	P	P				
LFR		S	P			P	P	S			S	S
SCWR-Thermal	P					P	P	S	S			
SCWR-Fast	P	S				P	P	S	S			
VHTR	P					S			P	P	S	P

P: Primary Option
S: Secondary Option

				Structural Materials	
System	Spectrum, T _{outlet}	Fuel	Cladding	In-core	Out-of-core
GFR	Fast, 850°C	MC/SiC	Ceramic	Refractory metals and alloys, Ceramics, ODS Vessel: F-M	Primary Circuit: Ni-based superalloys 32Ni-25Cr-20Fe-12.5W-0.05C Ni-23Cr-18W-0.2CF-M w/ thermal barriers Turbine: Ni-based alloys or ODS
LFR	Fast, 550°C and Fast, 800°C	MN	High-Si F-M, Ceramics, or refractory alloys		High-Si austenitics, ceramics, or refractory alloys
MSR	Thermal, 700–800°C	Salt	Not Applicable	Ceramics, refractory metals, High-Mo Ni-base alloys (e.g., INOR-8), Graphite, Hastelloy N	High-Mo Ni-base alloys (e.g., INOR-8)
SFR (Metal)	Fast, 520°C	U-Pu-Zr	F-M (HT9 or ODS)	F-M ducts 316SS grid plate	Ferritics, austenitics
SFR (MOX)	Fast, 550°C	MOX	ODS	F-M ducts 316SS grid plate	Ferritics, austenitics
SCWR-Thermal	Thermal, 550°C	UO ₂	F-M(12Cr, 9Cr, etc.) (Fe-35Ni-25Cr-0.3Ti) Incoloy 800, ODS Inconel 690, 625, & 718	Same as cladding options	F-M
SCWR-Fast	Fast, 550°C	MOX, Dispersion	F-M (12Cr, 9Cr, etc.) (Fe-35Ni-25Cr-0.3Ti) Incoloy 800, ODS Inconel 690 & 625	Same as cladding options	F-M
VHTR	Thermal, 1000°C	TRISO UOC in Graphite Compacts; ZrC coating	ZrC coating and surrounding graphite	Graphites PyC, SiC, ZrC Vessel: F-M	Primary Circuit: Ni-based superalloys 32Ni-25Cr-20Fe-12.5W-0.05C Ni-23Cr-18W-0.2CF-M w/ thermal barriers Turbine: Ni-based alloys or ODS
<p>Abbreviations:</p> <p>F-M: Ferritic-martensitic stainless steels (typically 9 to 12 wt% Cr)</p> <p>ODS: Oxide dispersion-strengthened steels (typically ferritic-martensitic)</p> <p>MN: (U,Pu)</p> <p>MC: (U,Pu)C</p> <p>MOX: (U,Pu)O₂</p>					

Irradiation Testing of Fuels and Materials

Based on previous experience with development of fast reactor fuels and based on the range of maturity of the proposed fuel forms, varying needs for fuel development exist. In general, a long-term program to develop fuels entails the following activities: (1) fabrication process development, (2) property measurement and assessment, (3) irradiation testing and safety demonstration, and (4) modeling and predictive code development.

Four phases of development for the fuel are recommended as follows, which include the activities above to varying degrees:

- Fuel candidate selection
- Fuel concept definition and feasibility
- Design improvement and evaluation
- Fuel qualification and demonstration

The development for structural materials follows a similar path.

Irradiation Tests. All systems will need irradiation testing of fuels and materials for in-core components. The similar service conditions for systems and the limited availability of irradiation test facilities worldwide are two strong reasons to recommend a crosscutting irradiation testing program. The availability of fast-spectrum test facilities is a particular concern. The program should comprise tests and experiments at reactors in several countries with needed postirradiation examination and testing. The recommended R&D activities are summarized below:

- Inert environment tests of unirradiated and preirradiated structural material samples at relevant temperatures to assess radiation effects on mechanical behavior (strength, creep, fracture toughness) over the temperature range of interest and independent of coolant-induced phenomena.
- Special-effects irradiation tests in laboratories simulating the effect of neutrons and fission products on material microstructures using ion beams. Such tests would be used as a low-cost means for assessing microstructural evolution in structural materials or in matrix materials proposed for dispersion fuel concepts. These tests might include swift ion irradiation or fission product and helium implantation.
- Irradiation tests of material samples in prototypic neutron spectra and in flowing coolant loops (or

flowing fuel loops, in the case of the MSR) are fundamental to assess the effects of environmental degradation (e.g., due to radiolysis-enhanced corrosion and in situ radiation damage) on materials properties and performance. System-specific corrosion and environment testing of preirradiated samples would provide a low-cost means of assessing the impact of radiation damage on environmental degradation of performance.

- Preliminary tests of new fuel designs (either new fuel forms or new compositions) in a specially configured vehicle in a test reactor to identify irradiation performance issues.
- Irradiation tests of prototypically designed test fuels to determine fuel lifetime and life-limiting phenomena in proposed fuel designs.
- Irradiation tests of reference fuel designs at conditions of power and temperature that determine limits for safe and reliable operation of fuels. This information will be essential for supporting a licensing case for a first-of-a-kind reactor.

Many of the above activities are more fully described in the R&D recommended for each system. Other crosscutting R&D is discussed next.

Transient Testing of Reactor Fuels

All Generation IV systems will require transient testing. Fuels that are in initial development stages will require transient testing, independent of design-basis accident issues, to understand transient response and to aid design changes that ensure required safety-related behavior. Fuels that have matured to the point of reference designs will require transient testing under a range of accident conditions, including those beyond the design basis, to determine mechanisms that lead to fuel failure, threshold conditions at which failure occurs, and the relocation/dispersal behavior of failed fuel under bounding accident conditions. Fuels with established performance databases will require testing at specific design basis accident conditions to verify that behavior in the system is as expected, which will be an important step in qualifying the fuel for licensing. Crosscutting R&D is recommended to establish a transient testing capability to serve common needs.

Fuels and Materials Selection and Performance

Because many classes of materials are candidates, an activity to determine the intrinsic properties of materials and their irradiation-performance is recommended. Major activities are described below.

Mechanical Performance and Dimensional Stability.

R&D is recommended to study and quantify mechanical performance and dimensional stability properties. For the range of service conditions expected in Generation IV systems, including possible accident scenarios, the proposed materials must meet design objectives in the following areas:

- Dimensional stability, including void swelling, thermal creep, irradiation creep, stress relaxation, and growth
- Strength, ductility, and toughness
- Resistance to creep rupture, fatigue cracking, and helium embrittlement
- Neutronic properties for core internals
- Physical and chemical compatibility with the coolant
- Thermal properties during anticipated and off-normal operations
- Interactions with other materials in the systems.

For each design objective, the fundamental microstructural features that establish performance (such as dislocation microstructure, void microstructure, precipitate microstructure, and radiation-induced segregation) must be understood to allow for further performance improvements. The formation and behavior of these features depend on materials temperature and neutron flux and spectrum. For example, higher-energy neutron spectra induce more radiation damage into the microstructures of materials, which impacts the formation of and phenomena associated with microstructural features that degrade properties. At elevated temperatures, radiation damage is more quickly annealed. An additional objective is to limit impacts of neutron activation of components, which can complicate maintenance, handling, and disposal of irradiated components, through careful selection of material constituents.

Candidate alloys for the 300–600°C temperature range include austenitic iron- and nickel-base alloys, ferritic-martensitic alloys and oxide-dispersion strengthened ferritic and austenitic alloys. The primary materials candidates for 600–900°C range are those with good strength and creep resistance at high temperatures, such as oxide-dispersion strengthened ferritic-martensitic steels, precipitate-strengthened iron- or nickel-base superalloys, coated materials, or refractory alloys of molybdenum, niobium, and tantalum. Materials issues for applications at temperatures exceeding 900°C become increasingly severe. Of the potential metallic

materials, only tungsten- and molybdenum-based systems are believed to have the potential to operate in this temperature range. However, the potential limitations of metallic alloys at higher temperature motivate consideration of ceramic materials. The extreme temperatures also present challenges for conducting experiments in existing irradiation facilities.

Materials for Balance-of-Plant. The materials to be selected for balance-of-plant components will be challenged by high operating temperatures and compatibility issues that are introduced with alternative energy products. For example, generation of hydrogen will entail environments that are potentially corrosive or embrittling to some materials.

Materials for Fuel Recycle Equipment. Although much of the emphasis of this section is on fuels and materials for reactor systems, the success of the fuel recycle technologies will depend upon selection of materials that allow fuel processing and fabrication under harsh environmental conditions, such as high temperature, radiation fields, and aggressive chemical environments. In addition, the selected materials must resist interaction with the recycled fuel media, which is essential to achieving low loss of actinides to secondary waste streams. Therefore, a crosscutting materials R&D activity associated with recycle technology is recommended.

Dispersion Fuels. Traditional fuel forms appear in most Generation IV systems as preferred options. However, it is recommended that less mature fuels forms, dispersion fuels in particular, may be explored as part of the crosscutting R&D. Specific systems that this fuel form might benefit include the SCWR, GFR, VHTR, SFR and LFR systems.

Fuels and Materials Modeling

The design of new alloys for Generation IV systems is an extensive undertaking requiring considerable resources. Experimental programs will be limited by the amount of available resources, thus limiting the data or perhaps the degree to which prototypic conditions and geometries can be studied. The capability to model material properties and performance will be valuable for guiding experimentation, interpreting experiments, and increasing the understanding of proposed alloy system properties and performance. Modeling of microstructure evolution under irradiation is recommended to improve the understanding of the response of various alloy systems to the higher-temperature and dose conditions.

Fabrication Processes and Techniques

Joining Techniques. Little experience with fabrication and joining exists for many of the metallic and ceramic components proposed for Generation IV systems. Therefore, R&D is recommended to assess and develop applicable joining techniques.

Fabrication of Ceramic Fuel. Four of the fuel options are ceramic fuels. The R&D plans for the mixed oxide-fueled sodium-cooled reactor include development of the simplified pelletizing method, which is intended to provide a fabrication scheme that is simpler and less contamination intensive than the currently used techniques. A modest R&D activity to consider whether the simplified pelletizing method can be extended to multiple ceramic fuels is recommended. Similarly, the vibrational compaction technique of fabricating ceramic fuels is an alternative for fabricating MOX fuel for sodium-cooled reactors. R&D to consider application of the vibrational compaction technique to other Genera-

tion IV ceramic fuels is also recommended. R&D into ceramic fabrication process for composite ceramic fuels should also be considered to yield new alternatives for the systems.

Establishment of Standards and Codes. Because Generation IV systems will require deployment of materials and components operating under new conditions, codes and standards must be established for their use. Materials composition and property data that are collected during the development of Generation IV technologies should be obtained in accordance with quality assurance standards so that they may provide the necessary basis for codes and standards, and for licensing.

Crosscutting Fuels and Materials R&D Schedule and Costs

A schedule for the crosscutting fuels and materials R&D is shown below, along with the R&D costs and a decision point.

FUELS & MATERIALS CROSSCUT (220 M\$)

Irradiation Testing Preparation (50 M\$)

- Define requirements for irradiation and transient testing
- Requirements for irradiation and transient test facilities decision (FM 1)
- Design and construct test vehicles for fast-spectrum testing of fuel and/or materials samples
- Design and construct test loops for use in thermal-spectrum test reactors
- Irradiate materials samples in a fast neutron test vehicle

Structural Material Properties & Behavior (50 M\$)

- Conduct measurements of mechanical & corrosion properties of unirradiated alloys
- Conduct irradiations & measurements to establish microstructural/chemical stability of alloys
- Conduct mechanical testing & corrosion and stress corrosion cracking experiments on irradiated samples
- Conduct in-pile tests to assess mechanical & corrosion aspects

Fuel Materials Properties (30 M\$)

- Measure fuel properties required for viability R&D
- Measure fuel properties required for performance R&D

Reactor Fuel Transient Testing (20 M\$)

Fuel Fabrication Technique Development (10 M\$)

- Develop simplified pelletizing method
- Develop parameters for vi-pac fabrication of ceramic fuels

Materials Phenomena Modeling (10 M\$)

Joining Techniques & Non-destructive Evaluation (30 M\$)

- Adapt or develop, as necessary, joining techniques
- Establish non-destructive inspection techniques

Codes and Standards (20 M\$)

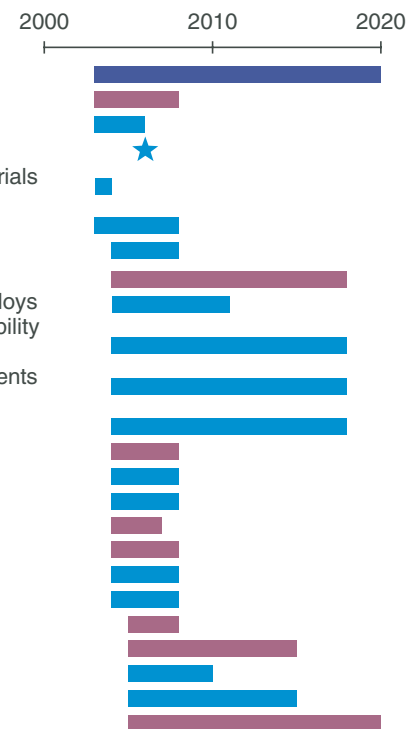

Crosscutting Energy Products R&D

Introduction and Approach

Most Generation IV systems are aimed at technology advances that enable high operating temperatures. The high temperatures will allow the production of new products such as hydrogen and process heat, as well as electricity production with higher efficiency cycles. This section addresses the crosscutting R&D needed for these new products and cycles for Generation IV systems.

The table below summarizes the energy production technology options for each Generation IV system. The choice among hydrogen production technologies is most closely linked with the effective temperature that heat can be delivered from the reactor, which is a function of the outlet temperature and the heat transfer properties of the primary coolant, or secondary coolant in the cases where an IHX is required.

the Ca-Br process as an alternative if it can be developed as a cost-effective method. Nearer-term technology for hydrogen production may be possible through steam reforming of methane or hot electrolysis of water. Nearer-term opportunities for hydrogen use include petroleum refining. This may require plants with sizes ranging from 50 to 500 MWth. However, the most recently ordered hydrogen production plants (using steam reforming of natural gas) are systems up to 2000 MWth.

Generation IV systems may potentially be used for a variety of process heat applications: urea synthesis, wood pulp manufacture, recovery and de-sulfurization of heavy oils, petroleum refining, manufacture of naphtha, ethane and related products, gasification of coal, and manufacture of iron, cement, or glass. The minimum required temperature for some of these applications is about 600°C. So, the GFR, MSR, LFR, and VHTR systems could potentially serve them.

Generation IV System (T _{outlet})	Hydrogen Production		Heat Delivery		Advanced Cycles for Electricity Production		
	I-S Process	Ca-Br Process	Process Heat	Desalination	Supercritical CO ₂ Brayton	Water Rankine Supercritical	Helium Brayton
GFR (850°C)	P	S	S	O			P
MSR (700-850°C)	P	S	S	O			P
SFR (550°C)				O	S		
LFR (550°C)				O	P	S	
(800°C)		P	S	O	S ¹	S ¹	
SCWR (550°C)				O		P	
VHTR (1000°C)	P		S	O			P

P: Primary option
 S: Secondary option
 O: Option for all systems

¹ Bottoming cycle using heat at lower temperatures available after higher temperature heat has been used for hydrogen production.

The entries in the table are primarily determined by the outlet temperature and the choice of coolant. For example, the I-S process for hydrogen needs heat delivered above 800°C, and the process efficiency improves above this temperature. The GFR anticipates outlet temperatures of 850°C, and the VHTR anticipates 1000°C and the MSR has the potential to reach 850°C. The SCWR, LFR, and SFR deliver heat below 800°C, and therefore do not consider using the I-S process. The LFR system proposes development of a lower temperature Ca-Br process as an alternative for hydrogen production, which may potentially produce hydrogen at temperatures above 700°C. Others may consider using

The need to provide potable water to the expanding population in arid regions is potentially an emerging application for nuclear power. Removal of salt and other impurities from seawater or brackish waters generally uses one of two basic approaches: distillation or processing through membranes. These methods typically require heat input at 80–120°C and electricity to operate the pumps. Nuclear sources may also potentially serve as heat sources for district heating. The temperatures required are typically low, of the order of 80°C. Thus, all six Generation IV systems may consider bottoming cycles that would include desalination and district heating.

For the generation of electricity, the supercritical water Rankine cycle is a central feature of the SCWR system at 550°C. The LFR system could also use the supercritical water Rankine cycle, but this system has the potential to improve its efficiency with a supercritical CO₂ Brayton cycle. The GFR, MSR, and VHTR could use advanced helium Brayton cycles.

Two generic issues arise for energy products, underscoring a need for R&D. These are discussed next, followed by a survey of energy production technology R&D recommendations.

Product Purity. Three of the potential Generation IV energy products—hydrogen, fresh water, and district heat—go directly to consumers. For these, product quality and potential contamination are issues, with the most probable concern being tritium. Two sources of tritium must be considered: it is a ternary fission product and potentially an activation product in the primary coolant. For desalination and district heating, this is less of an issue because the low temperatures inhibit tritium diffusion through intermediate heat exchangers. Hydrogen production is in a temperature range of concern, where the diffusion of tritium through high-temperature heat exchangers and other components is difficult to limit.

The best approach is to avoid tritium generation, which is primarily accomplished through choice of materials. In addition, R&D is needed to determine how to limit tritium diffusion through coatings or barriers or how to separate tritium at various stages. Tritium can be separated from hydrogen by using purification systems. However, this may have a significant impact on hydrogen cost and should be avoided if possible.

Integrated System Safety. R&D is recommended to address the integrated safety requirements of a nuclear source with a hydrogen production or process heat plant. This will require close interaction with the chemical and refining industries. One R&D approach is to examine how risk is evaluated in the chemical industry, and integrate and reconcile it with the risk and safety requirements for nuclear installations. In addition, mechanical systems such as fast acting isolation valves must be developed to be placed in the line leading to chemical plants. Other new requirements may emerge concerning reliability of heat exchangers as well to meet these integrated plant safety needs. For the chemical plants, it will be necessary to thoroughly understand energetic accidents utilizing deterministic and probabilistic risk assessment (PRA) approaches. For the reactor events beyond the design basis, accidents must be assessed using PRA methods.

As the requirements for other energy products and applications are more specifically defined, further crosscut issues will emerge. Additional R&D may be needed to address these emerging needs.

Iodine-Sulfur (I-S) Process Technology R&D

The I-S process involves three component chemical reactions in a thermochemical water-splitting cycle for the production of hydrogen. The system creates H₂SO₄ and HI, separates the acids, and carries out reactive decomposition of HI and concentration and decomposition of H₂SO₄. The sulfuric acid can be decomposed at about 825°C, which defines the temperature of heat addition.

Materials and Database. Currently, the I-S process technology requires temperatures in the range of 800–900°C. R&D needs include thermochemical property measurements and databases, rate constant measurements for the chemical processes, measurement of thermodynamic equilibrium data, thermodynamic optimization, and development of flowsheets. R&D needs also include materials compatibility, corrosion, and lifetime. Appropriate materials must be selected and tested. Additional work would involve studies on ensuring product quality, investigation of membrane and substrate technologies, effects on mechanical properties, and determination of any surface modifications.

Bench Scale and Pilot Scale Testing. Additional activities are recommended to design, build, and operate a laboratory-scale, completely integrated, closed-loop experiment driven by a nonnuclear heat source. This scale would produce hydrogen and oxygen at about 1-10 liters per hour, and provide proof of principle and verification of the chemical reactions in the closed cycle.

Following bench-scale testing, a pilot plant will need to be operated using prototypical materials and technologies. The pilot plant would also operate on nonnuclear heat to demonstrate the technologies and materials of a full-size plant.

Calcium-Bromine (Ca-Br) Process Technology R&D

The calcium-bromine process has the advantage of operating at a lower temperature than the I-S process, in the range of 725–800°C. However, the Ca-Br process uses four gas-solid reactions that take place in stationary beds, and is less efficient than the I-S process due to the lower temperatures. The heat necessary to drive hydrogen generation is supplied to a gas stream that contains a large excess of high-pressure steam. Hydrogen and oxygen are removed from the gas stream through

semipermeable membranes. The stationary beds are arranged with four sets of cross-over valves to alternate the gas flow through the CaO/CaBr and FeBr₂/Fe₃O₄ beds.

Materials and Database. There are two sets of issues in the development of the Ca-Br process for further research. First, the process reactants (steam, hydrogen, and hydrogen bromide) at 600–750°C will require materials research to determine corrosion/erosion mechanisms and kinetics. Materials will have to be selected and tested for piping and vessels.

The second set of issues pertain to the reactions and their kinetics. Support structures for the beds must be developed, and the reaction kinetics as a function of conditions and structures must be determined. For the process, the use of stationary beds with cross-over valves will require development and pilot-plant operation to determine whether the alternating flow through the beds will have an effect on reactor operation. A fluidized bed alternative, which avoids alternating flow, should be investigated.

Repeated chemical and thermal cycling of the solid materials may also lead to cracking and the formation of dust in the process stream. Pilot-plant operations are recommended to develop techniques for avoiding dust formation or needed dust removal. Dust is also an issue in the operation of the semipermeable membranes for H₂ and O₂ separation. Pilot-plant operation is recommended to test the membranes in realistic chemical, temperature, and dust operating environments.

Supercritical CO₂ Brayton Cycle Technology R&D

The supercritical CO₂ Brayton cycle offers the potential for surpassing 40% energy conversion, even at the more conventional 550°C coolant temperature. The R&D required to show viability of this innovation includes (1) confirmation of materials selections from other industries already using sub- and supercritical CO₂, (2) thermodynamic optimization of the cycle, (3) design of the recuperator and of the heat exchangers, and (4) design and pilot testing of a small-scale turbine or turbine stage and transient testing of a small integrated power plant. A limitation of the use of supercritical CO₂ exists due to dissociation at temperatures above 700°C.

Supercritical Steam Rankine Cycle Technology R&D

For the generation of electricity, the supercritical water Rankine cycle is already found in industrial use, notably

in coal plants. The application of the supercritical steam Rankine cycle to Generation IV systems requires examination of several key interfaces, such as the development of in-vessel steam generators for the LFR system.

Process Heat Interface R&D

A minimum temperature of 600°C was chosen for process heat applications or production of high-quality steam for industrial use. Research is underway on a number of processes other than thermochemical, such as direct-contact pyrolysis and conversion of agricultural feedstock, which may further reduce the temperature requirements.

R&D is needed for high-temperature heat exchangers involving gas-to-salt, liquid-metal-to-salt, or supercritical-steam-to-salt. These are an alternative for many of the Generation IV systems, but numerous performance requirements differentiate them. For example, some have large pressure differences across the IHX, high pressures, and challenges in corrosion.

Desalination and District Heating Interface R&D

This area of R&D considers desalination to produce fresh water. With regard to desalination, multiple approaches are possible either through direct use of low temperature heat (120°C) or through optimized reverse osmosis processes. With regard to district heating, a nuclear-supplied district heating network has operated for almost two decades in Switzerland. This provides a valuable benchmark for evaluating district heating applications. Many cities in Eastern Europe, Russia, and the Former Soviet Union are already equipped with a district heating infrastructure.

In the Brayton cycle, coolant temperatures in the heat exchanger range from 150°C down to 30°C and discharge heat to the low-temperature heat sink. In thermochemical processes such as the I-S process, heat in the range of 100–150°C is available. Thus, the Brayton cycle and thermochemical processes for hydrogen production may potentially be combined with desalination, district heating, or numerous other process-heat applications as a co-generation system without reducing the thermal efficiency of electricity generation or hydrogen production. R&D is recommended to explore the impact on the overall plant design and optimization.

Crosscutting Energy Products R&D Schedule and Costs

A schedule for the crosscutting energy products R&D is shown below, along with the R&D costs and decision points

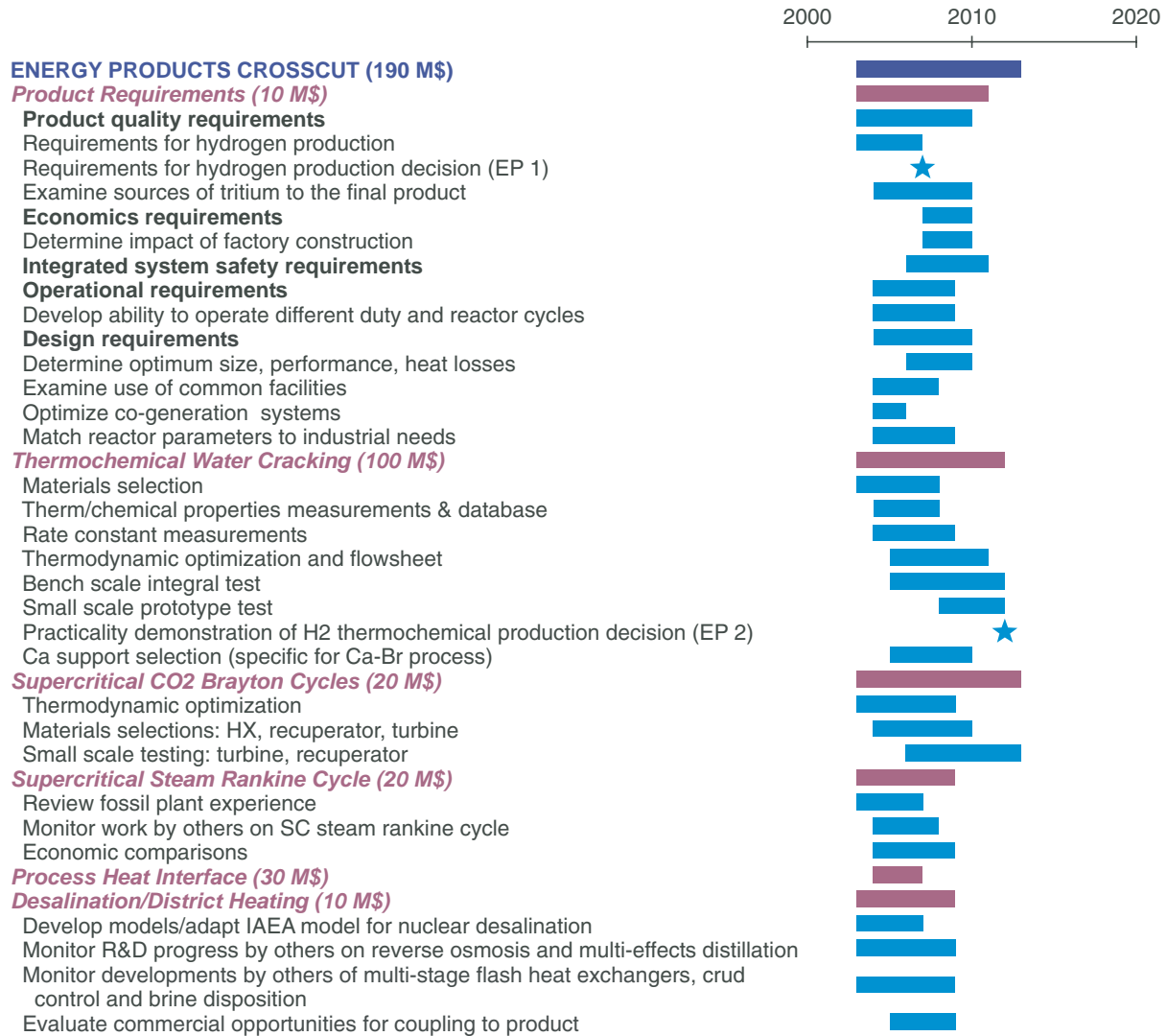

Crosscutting Risk and Safety R&D

Introduction and Approach

Crosscutting R&D for risk and safety is considered in this section. Recommendations are made for research activities that are relevant to the viability and performance assessments of future nuclear energy systems in meeting the three Generation IV safety and reliability (SR) goals.

Under SR Goal 1, research focuses on those events of relatively high to moderate frequency that affect worker safety, facility reliability and availability, and the frequency of accident initiating events. Under SR Goal 2, research focuses on those low-probability event sequences that can lead to core degradation, or in other facilities to the release of radionuclides from their most immediate confinement, or to nuclear criticality with risk for undue exposures. Under SR Goal 3, research focuses on those very low probability accident sequences where significant core degradation or other release could occur, and the performance of additional mitigation measures that reduce and control releases outside the facility and doses to the public.

Generally, few viability phase R&D issues exist that crosscut multiple systems, primarily because viability issues tend to involve unique and less understood characteristics of specific systems. The crosscutting issues that do emerge arise primarily from SR Goal 3, and from the need to have a consistent methodology for SR viability assessment of systems where detailed design information is not available. The opportunity to use common test facilities to conduct crosscutting investigations of fuel transient behavior, including fuel failure and dispersal mechanisms in accidents beyond the design basis, is described in the roadmap section on Crosscutting Fuels and Materials R&D. That research bears directly on SR goals 2 and 3.

Different nuclear energy systems employ different strategies to meet the specific SR goals. However, by the end of the viability phase R&D, each system must have a safety case that identifies initiators and strategies for response. A standard methodology is needed to provide a consistent evaluation with respect to the Generation IV SR goals for these different strategies. The capability to accurately calculate safety margins and their uncertainties from all sources will play an important role in the viability and performance evaluations of Generation IV systems, because it will provide a quantitative basis for optimization of their designs.

At the time of SR viability evaluation for a given Generation IV system, the design of the reactor and fuel cycle facilities must have sufficient detail to allow comprehensive description of the implementation of the lines of defense that provide defense in depth, including measures available to mitigate the consequences of core and plant degradation during design extension conditions (formerly beyond design basis). The design detail must also allow use of simplified PRA to identify design basis accidents and transients as well as the highly hypothetical sequences. The detail should be sufficient to identify and rank phenomena of importance to transient response and to specify experimental information required to validate transient models. The table on the next page summarizes the level of design detail required for this evaluation.

Crosscutting SR Viability Phase R&D

System Optimization and Safety Assessment

Methodology. Generation IV viability evaluations will be performed with incomplete design information. For these evaluations, the deterministic concept of defence in depth needs to be integrated with simplified probabilistic considerations (e.g., systems reliability and probabilistic targets) to provide metrics for acceptability and a basis for additional requirements, and to ensure a well-balanced design. This methodology must explicitly identify the assumptions and approximations used in the simplified process, to ensure that these assumptions and approximations are addressed during performance R&D. Several Generation IV systems have unique, new assessment issues. For example, many employ passive safety characteristics and systems to a much greater extent than current nuclear facilities. The failure of passive components requires a complex combination of physical and human factor ingredients. This poses an issue for PRA methodology because there is less experience in modeling passive systems compared to active systems. Moreover, system-specific operating data are sparse and may not provide statistically useful information.

The Code Scaling, Applicability, and Uncertainty (CSAU) method can in principle treat such problems, but has thus far been applied primarily to LWRs and requires more extensive design and modeling information than is available during the viability phase. Modeling Generation IV systems requires improved approaches to predict events of extremely low probability or events that arise from incomplete knowledge of potential system interactions and human factors. Research focused on the factors that affect the reliability, and

ability to predict reliability, of passive safety components and interactions between components has the potential to improve the quality of the viability evaluations. In addition, such a methodology should take into account coupling of Generation IV nuclear systems to alternative energy product plant systems.

Emergency Planning Methods. By virtue of their relatively small accident source terms, very slow transient response, low uncertainty in accident phenomenology, and extremely low probability for the scenarios resulting significant radionuclide release off site, several Generation IV systems could potentially benefit from emergency planning tailored to their characteristics. Specifically, it has been proposed that emergency planning zone radii or other planning actions different than that used for existing reactors, as well as alternative severe accident mitigation methods such as filtered confinements, could be appropriate for some of the Generation IV systems.

R&D is recommended to define the technical basis underlying existing emergency planning. The technical basis should be used to establish methods for the design and analysis of Generation IV systems to demonstrate that all design basis transients, accidents, and design extension conditions have been identified, that transient analysis has sufficiently low uncertainty, and that defense-in-depth has been implemented robustly, so that protective action guidelines for modified emergency planning requirements can be met. The approach should be developed in coordination with national regulators and other responsible authorities.

Crosscutting SR Performance Phase R&D

There are additional SR technology R&D areas where advances have the potential to improve the SR goal performance of most or all Generation IV facilities. Many of these domains will likely be studied under near-term deployment research for application to near-term systems. Generation IV facilities should build on such developments.

Licensing and Regulatory Framework. Many Generation IV systems involve substantial changes in safety-system design and implementation that require licensing implementation significantly different from current experience. Best-estimate and risk-informed bases for

Design Detail for SR Viability Evaluations

For SR viability evaluation, the level of design detail for reactor and fuel cycle facilities should be sufficient to allow:

- Description of the facility design features that implement the five individual levels of defense as defined by INSAG-10,
- Performance of a simplified PRA to accurately quantify the contribution to the risk of all the design-basis transients and accidents resulting from internal and external events, for all facilities and all operating modes and assess their approximate probabilities,
- Identification and ranking of the phenomena that govern the system transient response under design basis and design extension conditions,
- Demonstration that separate effects experimental data are available, or are planned for, that closely replicates the scaled boundary and initial conditions for the dominant phenomena with minimal distortion,
- Performance of selected best-estimate design-basis transient and accident analyses demonstrating the quantitative evaluation of uncertainty, and explicitly identifying approximations and assumptions that will be removed by subsequent performance R&D, and
- Description of the integral test facilities and their instrumentation planned to validate system transient response models, preferably at prototypical scale.

licensing will play a stronger role, due to the greater simplicity and improved uncertainty characterization for the new safety systems. R&D is recommended to develop more flexible risk-informed regulatory tools for licensing of these advanced systems, and for increasing international consistency in design for licensing.

Radionuclide Transport and Dose Assessment. R&D is recommended to develop improved phenomenological and real-time transport and dose modeling methods to support improved real-time emergency response, as well as optimize emergency planning methods and requirements.

Human Factors. One of the main objectives of crosscut R&D into human factors should be to identify and characterize the plant and systems design features that influence human performance in operation and maintenance, and to create quantitative criteria to enable effective comparison of Generation IV systems and make design decisions. For example, the decision to

maintain humans in an active role in the management of future plants and decisions that set their actual level of responsibility should be based on objective evidence for positive contributions to plant safety and reliability. R&D is recommended for these objectives.

Additional R&D Areas. Crosscutting R&D during the performance phase is recommended in the following areas:

- Operation and maintenance
- Instrumentation, control, and the human machine interface
- Reactor physics and thermal-hydraulics, including possible application of coolants with dispersed nano-phase particles for improved performance
- Risk management.

Safety and Reliability Evaluation and Peer Review

Due to the limited information on the detailed design of Generation IV systems, reviews in the roadmap have focused on intrinsic characteristics. These characteristics affect the potential performance to the safety and reliability goals, such as the thermal inertia associated with reactor cores. Intrinsic characteristics provide a strong foundation but still play only a partial role in the safety and reliability of nuclear energy systems. The details of the facility designs and the fundamental safety architecture also have a high importance to the evaluation.

Considering the importance of the safety and reliability of Generation IV systems, research on systems should include an effective safety and reliability peer-review mechanism. This process should be structured to ensure that the best design practice is employed in all Generation IV facilities, with a particular focus on the correct implementation of defense in depth principles.

Crosscutting Risk and Safety R&D Schedule and Costs

A schedule for the crosscutting risk and safety R&D is shown below, along with the R&D costs.

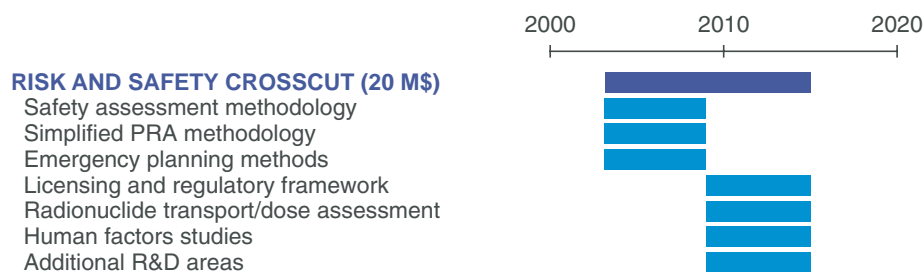

Crosscutting Economics R&D

Introduction and Approach

This section addresses crosscutting economic research relating to Generation IV nuclear energy systems. As discussed in the Observations on Economics section earlier in the roadmap, there is a need for crosscutting R&D to (1) base cost estimates on a robust and comprehensive methodology addressing uncertainties, and (2) resolve the issue of modular versus monolithic plant economics. In addition, research is needed into the basis and allocation of costs for nonelectrical products. Researchers and designers will need to continually address system economics as the R&D proceeds, and tools are needed to guide them. The objective of these tools is to improve the consistency of economic assessments and uncertainties associated with them. With new tools, Generation IV designers can gain a better understanding of how their designs compare with alternative nuclear systems or other technologies. They can identify areas deserving specific attention and focus their efforts on improving the economic performance.

The innovative nuclear systems within Generation IV will require unique tools for their economic assessment, because their characteristics are very different from those of earlier nuclear power plants. Specifically, there are five main economic tools that should be refined from existing tools or developed as new tools (see figure).

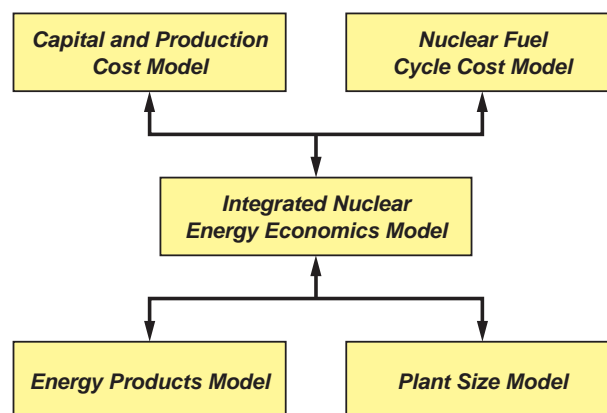

These consist of four standalone cost models, as well as an overall model that integrates them for the purpose of exploring uncertainty ranges in the input. These models are needed during the viability phase of system R&D to give a preliminary answer to the question of economic viability that is central to all of the Generation IV systems.

A number of methods and computer models exist that can estimate the cost of a reactor under development, i.e., before there is experience constructing and operating it. Most of these models were implemented in the early stages of nuclear energy deployment (during Generation II) and updated on a regular basis during the period. However, most nuclear power plants built recently are evolutionary, based upon designs and technologies that are mature and proven. Therefore, these cost assessment tools have not been updated since the early 1990s. Such models can form the basis for two models in the figure: the Nuclear Fuel Cycle Cost Model (or Fuel Model), and the Capital and Production Cost Model (or Cost Model).

The fuel and cost models are central to the economic evaluation of nuclear systems. An example of an existing fuel model is the OECD/NEA model used for preparing *The Economics of the Nuclear Fuel Cycle*.^d The fuel model calculates costs associated with both the front end and back end of the nuclear fuel cycle, and provides information needed by the cost model. An example of an existing cost model is ORNL's *Cost Estimate Guidelines for Advanced Nuclear Power Technologies*.^e The cost model inputs the cost of nuclear fuel to a calculation of capital costs, as well as the costs of production. Existing fuel and cost models, however, are not adapted to innovative fuel cycles. For example, minor actinide partitioning and transmutation cannot be analyzed.

A new model, the Plant Size Model (or *Size Model*) is needed to analyze costs and implications of a range of options for innovative systems. The size model needs to treat modular plants and the associated economies of serial production-construction as well as monolithic plants and the associated economies of scale for large units. By itself, the size model may help to determine the optimal size of the nuclear energy production plant within a Generation IV system.

Another new model, the Energy Products Model (or *Products Model*) would address the economics of multiple energy products. The products model would analyze system tradeoffs between, for example, low cost electricity generation and actinide management and/or hydrogen production.

An Integrated Nuclear Energy Model (or *Integrated Model*), combines all of the nuclear-economic models described above and provides a robust framework for economic optimization. The integrated model would be able to propagate the effects of uncertainties in the model inputs.

Capital and Production Cost Model (Cost Model)

An existing cost model, such as the cited model, should be updated. This, as well as most other production cost models, uses the lifetime-levelized cost methodology. This methodology calculates costs on the basis of net bus-bar power supplied to the station. Applied to generation costs, the lifetime-levelized cost methodology provides costs per unit of electricity generated equal to the ratio of (1) total lifetime expenses and (2) total expected generation, both expressed as discounted present values. Those costs are equivalent to the average price that would have to be paid by consumers to repay the investor for the capital and the operator for O&M and fuel expenses, at a discount rate equal to the rate of return. The cost model must include all aspects of construction, including sequencing and duration of plant construction or fabrication tasks. Further, capital expenditures should include refurbishment (also known as capital additions) and decommissioning costs. Real escalation rates (nominal escalation rates minus the general level of inflation) for operation and maintenance and fuel costs are taken into account if applicable.

To assess the economic advantage of nuclear energy systems over alternatives, all costs facing the utility, i.e., those that would influence its choice of generation options, should be taken into account. In particular, the costs associated with environmental protection measures and standards, e.g., the cost of safety and radiation protection measures for nuclear systems, should be included in life-cycle costs. On the other hand, external costs that are not borne by the utility, such as costs associated with health and external impacts of residual emissions, are not included. However, if external costs

^dOrganisation for Economic Cooperation and Development and the OECD Nuclear Energy Agency, 1994, www.nea.fr/html/ndd/reports/efc, accessed September 2002, This publication is out of print and can be obtained only from this website.

^eJ. G. Delene and C. R. Hudson, *Cost Estimate Guidelines for Advanced Nuclear Power Technologies*, ORNL/TM-10071/R3, Lockheed Martin Energy Systems, Inc., Oak Ridge National Laboratory, 1993.

are borne by the public or the environment, public agencies should take these costs into account when choosing among nuclear technologies. A limitation in the Lifetime Levelized Cost Methodology is that it is only relevant for deployment of new nuclear or other power plants in traditional cost-of-service regulated environment. The deregulation of electricity markets in most countries requires traditional cost models to be updated.

Nuclear Fuel Cycle Cost Model (Fuel Model)

Since fuel cycle costs represent about 20% of the levelized cost of new nuclear electricity generation in most current nuclear power plants, reducing those costs will help new systems meet the Generation IV economics goals. Further, fuel cycle cost models can play an important role as a decision tool for optimizing fuel cycle options by taking into account economic tradeoffs between design choices in sustainability, safety and reliability, and proliferation resistance and physical protection. The model used to prepare the report, *The Economics of the Nuclear Fuel Cycle (1994)*, is an example of existing tools capable of handling the classic fuel cycles.

The assessment of innovative fuel cycle economics is essential and requires updating existing models. For classic fuel cycles, the main steps are uranium production, conversion, enrichment (not needed for natural uranium fuel cycles), fabrication, and spent fuel disposal for the once-through option. In the recycle option, the back end of the fuel cycle includes reprocessing, refabrication, and disposal of HLW from reprocessing. Innovative fuel cycles will require the adaptation of existing models to include different steps, materials, and services. For very unique systems, such as the MSR, the design and implementation of an entirely new fuel model may be required.

An updated fuel model should include recent developments in the understanding of reprocessing and repository economics. It must provide complete front and back end costs to the cost model.

Energy Products Model (Products Model)

The economics of the joint production of electricity and other energy (nonelectrical) products needs to be better understood. For example, the economics of joint electricity and hydrogen production using nuclear energy has not yet been fully analyzed, let alone modeled. Because most of the Generation IV technologies can be used to address more than one mission, crosscutting economics research must define standards for

accounting for the costs of more than one product. Further, the tradeoff between the use of heat to produce hydrogen and residual heat to produce electricity is also not well specified. Similarly, the joint production of electricity and actinide management services requires further analysis. Standard economic models must be developed to evaluate these tradeoffs under various regulatory and competitive environments. At the same time, it is critical to the Generation IV effort to understand the supply (industry cost structure) and demand (including alternatives) for hydrogen and actinide management, and how this market will likely evolve during this century. In particular, using Generation IV technologies to manage actinides requires the specification of the feedback mechanism between the production of spent nuclear fuel and its life-cycle management.

Plant Size Model (Size Model)

An issue that has not yet been resolved in the assessment of advanced reactor technologies is whether mass production of small reactors can overtake the cost advantages from scale economies of large units or plants. There are cost factors involved in the construction of a small modular plant that are not encountered nor accounted for in the conventional cost computation of a large monolithic plant. To make a reasoned economic decision as to which plant to select, it is essential that all the cost factors involved are considered. In general, specific plant capital costs, expressed in currency per installed kWe (e.g., \$/kWe) are lower for a large plant, due to economies of scale. Yet there are significant advantages to the early construction completion and start-up of smaller plants (e.g., an early revenue stream) that do not routinely appear in the standard cost accounting system developed for large monolithic plants.

There are several specific cost factors that should be accounted for when comparing the economic advantages of large versus small and modular nuclear power plants. Such factors include (1) load management and reliability, (2) standardization and licensing, and (3) retiring plant replacement possibilities, among others. Economic models should reflect these factors to ensure a fair assessment of the potential economic benefits of small modular systems versus large monolithic systems. More work must be done to properly account for the differences between small and large plants. While basic research in this area should be inexpensive, developing economic-engineering model would require more resources. For example, research in this area should be extended to developing the conceptual engineering design of fabrication facilities and transportation systems.

Integrated Nuclear Energy Model (Integrated Model)

An integrated model, combining all of the models identified above is necessary to compare various Generation IV technologies, as well as to answer optimal configuration questions, such as which fuel cycle is most suitable for each state of the world and optimal deployment ratios between members of symbiotic set. The goal of integrating these models provides incentives to build common data interfaces between the models.

Also, none of the individual models addresses the problem of uncertainty, e.g., the uncertainty of cost and parameter estimates. Roadmap evaluations on economics for Generation IV considered ranges, expected values, and probability distributions for construction cost, construction duration, and production costs. From these, probability distributions for average cost and capital-at-risk were generated assuming no correlation between costs and durations. The integrated model should be able to address these type of uncertainties. The integrated model will be able to guide decision makers in their assessment of these uncertainties, i.e., help them to assess the value of reducing uncertainty through the allocation or reallocation of research funds.

Model Development Steps

The models should be developed now for use during the viability phase of the Generation IV systems. The figure identifies the order of these tasks. During the first year:

1. The Cost Model should be created by updating an accepted model

2. The Fuel Model should be created by updating an accepted model
3. Reports should define the requirements for the other models.

During the next two years, these updated models should be integrated and work should proceed on the creation the Product and Size Models. During the last two years, all of the models should be integrated with a focus on addressing uncertainty. Further, the development of engineering designs of nuclear plant fabrication facilities should begin that would allow further refinement of the size model. These designs should include expected costs and these costs should be integrated into the integrated model. As an integrated set, the models will aid decision makers in assessing the viability of Generation IV systems and technologies.

Economics Evaluation Peer Review

Due to the limited information on the detailed design of Generation IV systems, reviews to this point in the roadmap have primarily considered studies advanced by advocates. Considering the importance of the economics of Generation IV systems, research on systems must adopt an effective economics peer-review mechanism. This process should be structured to ensure that the designs continually address their progress into competitive systems.

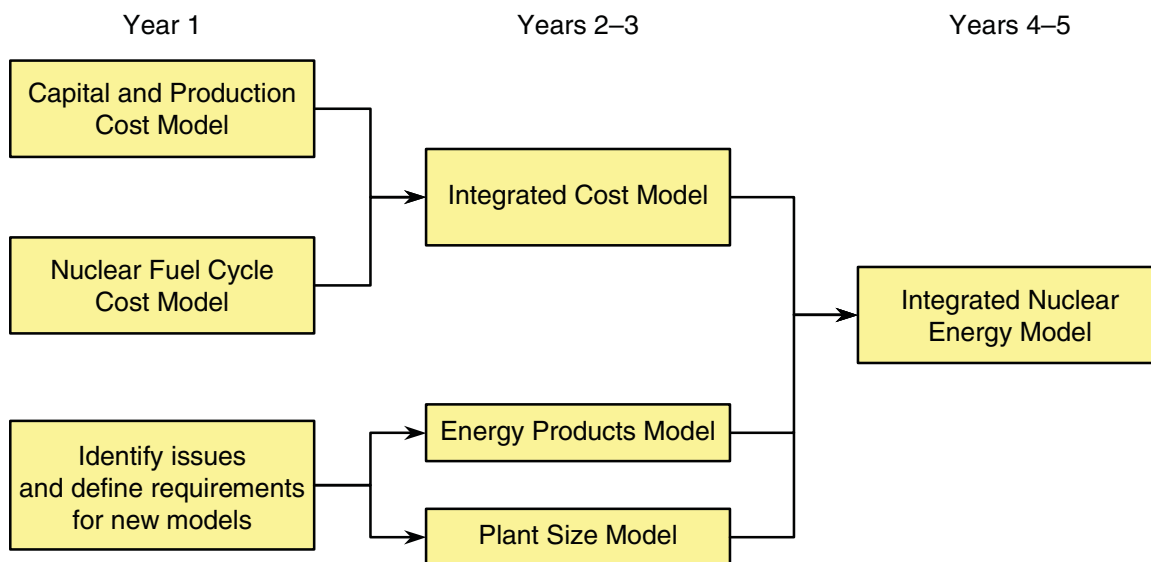

Crosscutting Economics R&D Schedule and Costs

A schedule for the crosscutting economics R&D is shown below, along with the R&D costs and a decision point.

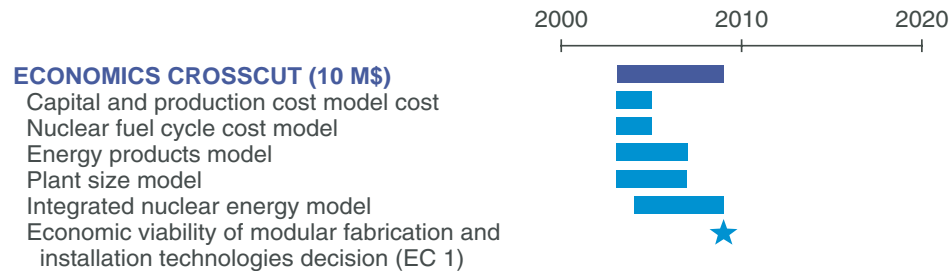

Crosscutting Proliferation Resistance and Physical Protection R&D

Introduction and Approach

The methodology developed during the roadmap provided only a limited evaluation of proliferation resistance and physical protection (PR&PP). A substantially improved PR&PP evaluation methodology is needed to provide a more balanced and complete evaluation. This section recommends R&D relevant to this goal area, followed by recommendations on R&D in evaluation methods.

One of the important endpoints of Generation IV R&D is a preliminary safeguards and security strategy that is developed during the viability R&D phase. The preliminary strategy will be conceptual and schematic in nature, reflecting the early state of development of the nuclear energy system. It addresses the vulnerabilities for each system in relation to the following five security threats:

- State-driven diversion or undeclared production of fissile materials
- Theft of fissile materials
- Theft of nuclear material for radiation dispersal devices
- Sabotage of nuclear facilities
- Sabotage of nuclear materials in transport.

During both the viability and performance phases, the strategy will be reviewed against a set of criteria and metrics relating to the intrinsic and extrinsic measures defined in the strategy to address the five security threats. The formulation of the criteria and metrics require R&D and are presented below. The evaluation

process is conducted by expert panels using an assessment methodology that is established through R&D. This R&D is also presented below.

Overall, the R&D program should be conducted in three areas. The first area is the safeguards and physical protection technology R&D that is carried out in the development of each Generation IV system. The final two areas are R&D needed for the formulation of PR&PP criteria and metrics, and their evaluation, respectively.

R&D Supporting the Safeguards and Physical Protection Strategy. The following R&D is recommended:

1. Determine the type, amount, and location of (1) nuclear materials suitable for weapons use, (2) other nuclear material from which such material could be created (through enrichment, reprocessing or irradiation followed by reprocessing), and (3) hazardous radioactive material. These should be defined in the context of each system and the provisions for its deployment over its entire life cycle.
2. Identify potential vulnerabilities for all materials in the fuel cycle for each of the five security threats. For each vulnerability identified, R&D should be carried out to decrease the attractiveness of the material for diversion or theft, or to increase the difficulty of dispersing the material, as appropriate.
3. Determine means to protect key reactor or fuel cycle facility technology that could be used for proliferation against unintended use, and related systems, equipment, and materials that could be used for proliferation against unauthorized replication.

4. For each material of any form in the system, identify and increase the intrinsic and extrinsic protection afforded against its diversion, theft, or dispersal. These means may exploit chemical or physical features, or use radiation barriers to decrease potential vulnerabilities.
5. For solution processing systems involving partial decontamination, such as the pyroprocess or advanced aqueous process, and for all processes involving molten salt fuel, identify potential means to extract nuclear material suitable for weapons use through the misuse of normal plant equipment or through the introduction of additional systems that might be concealed from discovery by the facility operator, the national control authority, or the International Atomic Energy Agency (IAEA).
6. Recognizing the importance of an ongoing consultative system, and consistent with the provisions of applicable IAEA safeguards agreements, interactions with the agency should start during the viability R&D phase. This effort would identify general aspects of the safeguards approach, alternative measures, and any system specific research and development needed to facilitate later agreement on the technical measures to be applied. When sufficient information is available about a particular system, the interaction with IAEA should lead to a case study by the Safeguards Department of the IAEA. During the performance phase, detailed aspects of the safeguards approach would be specified, developed, and tested. The capabilities of the safeguards system would be determined and improvements pursued as needed.
7. Using the simplified PRA for the system, identify the vulnerability to sabotage that could lead to releases of radioactive material or theft resulting from breaches in containment, and any additional measures appropriate to counter such threats. Specifically, the safety analyses should be reviewed from the viewpoint of intentional acts as the initiators for the safety sequences identified, taking into account the use of force including armed attack and the consequent possibilities for the destruction of critical safety systems or structures, and the potential acts of knowledgeable insiders to operate the facility or systems in an intentionally unsafe manner, or to disable or destroy critical safety systems.
8. Determine the potential use of the reactor for clandestine production of plutonium or ²³³U, the impact of such use on the safe operation of the reactor, the detectability of fertile material introduced into irradiation positions, and the detectability of changes in the neutronic or thermal-hydraulic behavior of the reactor. For any such potential use, investigate means to minimize the vulnerability.
9. For each step in the fuel cycle, define a concept for determining the amounts, locations, and characteristics of all material in real time. This would provide a foundation for the material protection, control, and accounting (MPC&A) system, and would provide the basis for the protective system employed by the facility operator. The foundation should include:
 - a. Information generated through in-line and off-line monitoring instruments
 - b. Information from sampling and laboratory measurements
 - c. Development and validation of inventory and flow predictive models for each operation and facility
 - d. Information processing algorithms for the estimation of amounts and properties of all materials
 - e. Quality control provisions.

R&D of PR&PP Evaluation Criteria and Metrics.

R&D is recommended to produce the set of criteria and metrics for the evaluation of the intrinsic and extrinsic barriers that address each of the five security threats. As with other criteria and metrics, these are expected to be refined to match the level of detail as the systems advance through viability and performance R&D.

R&D of the Assessment Methodology. Deterring proliferation and nuclear terrorism will rely upon the collective implementation of intrinsic and extrinsic measures that are intended to deter such acts. The selection and implementation of cost-effective combinations of such measures is complex, subtle, and involves many plausible alternatives. For this reason, efforts to evaluate the risks of proliferation and nuclear terrorism against a system of intrinsic and extrinsic barriers have not yet provided clear and convincing answers. Explicit, comprehensive methods for evaluating the adequacy and requirements for a safeguards and physical protection system are needed to assess the protection and response capabilities it provides.

R&D is recommended into the development of practical assessment methodologies. The research should reflect the needs of each potential user as a function of time, and the differences in information potentially available to each. The process of developing this methodology is likely to be iterative in nature, as it strives to encompass the complexity of the problem.

Crosscutting Proliferation R&D Schedule and Costs

A schedule for the crosscutting proliferation resistance and physical protection R&D is shown below, along with the R&D cost.



INTEGRATION OF R&D PROGRAMS AND PATH FORWARD

Introduction

This section suggests an approach to building a Generation IV program with the necessary and sufficient R&D. Issues and opportunities exist for the program, and these are explored in a discussion of the path forward.

Overall Advancement of Generation IV

Program Definition and Balance

With six most promising Generation IV systems and ten countries in the GIF, the approach to building integrated programs for any of the systems becomes an important issue. The GIF countries have expressed a strong interest in collaborative R&D on Generation IV systems. However, it has always been acknowledged that each country will participate only in the systems that they choose to advance. In light of the considerable resources required for the development of any Generation IV system—roughly 1 billion U.S. dollars each—not all six systems are likely to be chosen for collaborations. Those that are will need to assemble the priority R&D for the system and the necessary crosscutting R&D, and then set the desired pace for the program. The technology roadmap has been structured to allow the independent assembly of collaborative R&D programs.

With regard to the timing of programs, the figure shows an overall summary of the expected duration of the R&D activities for the various systems. It is apparent that the systems do not complete their viability and performance phases at the same time. As a result, for each of the systems, the GIF will need to periodically assess its ability to continue. The technology roadmap has taken care to include R&D on evaluation methodology that will support the need for these continuing assessments. After the performance phase is complete for each system, at least six years and several US\$ billion will be required for detailed design and construction of a demonstration system.

Cooperation and Partnerships

The GIF plans to focus their future meetings on the development of collaborative programs on several systems. Of considerable interest is the participation of industry in the Generation IV program, and its growth as the systems advance. While the prospects for demonstration and entry into commercial markets are a number of years into the future, the need exists for early involvement of industry to provide direction and keep a focus on the requirements for the systems.

R&D Programs for Individual Generation IV Systems

The technology roadmap has been structured to facilitate the assembly of larger R&D programs or smaller projects on which the GIF countries choose to collaborate. Programs would consist of all or most of the R&D needed to advance a system. Projects would consist of R&D on specific technologies (either system-specific or crosscutting) or on subsystems that are needed for a Generation IV system. In either case, the program or project should be focused on key technology issues and milestones. This section highlights the major milestones and development needs that have been identified in the R&D activities.

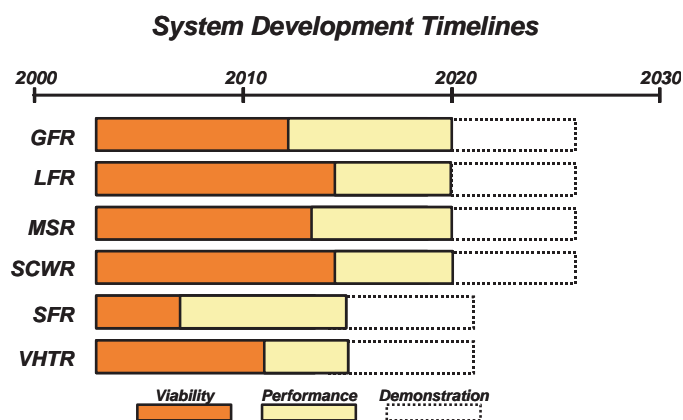

R&D Endpoints

To better define the viability and performance phase activities in the technology roadmap, the tables below suggest the objectives and endpoint products of the R&D, or *endpoints*. The R&D activities in the roadmap have been defined to support the development to these endpoints. The specific milestones and technology areas of the R&D are discussed next.

Viability Phase

The viability phase R&D activities examine the feasibility of key technologies. Examples of these include adequate corrosion resistance in lead alloys or supercritical water, fission product retention at high temperature for particle fuel in the very-high-temperature gas-cooled reactor, and acceptably high recovery fractions for transuranic actinides for systems employing actinide recycle. The tables on the next page present a summary of the decision milestones and their projected dates, assuming that the R&D can proceed at a reasonable pace.

<p>Viability Phase Objective:</p>	<p>Performance Phase Objective:</p>
<p>Basic concepts, technologies and processes are proven out under relevant conditions, with all potential technical <i>show-stoppers</i> identified and resolved.</p>	<p>Engineering-scale processes, phenomena, and materials capabilities are verified and optimized under prototypical conditions</p>
<p>Viability Phase Endpoints:</p>	<p>Performance Phase Endpoints:</p>
<p>1. Preconceptual design of the entire system, with nominal interface requirements between subsystems and established pathways for disposal of all waste streams</p>	<p>1. Conceptual design of the entire system, sufficient for procurement specifications for construction of a prototype or demonstration plant, and with validated acceptability of disposal of all waste streams</p>
<p>2. Basic fuel cycle and energy conversion (if applicable) process flowsheets established through testing at appropriate scale</p>	<p>2. Processes validated at scale sufficient for demonstration plant</p>
<p>3. Cost analysis based on preconceptual design</p>	<p>3. Detailed cost evaluation for the system</p>
<p>4. Simplified PRA for the system</p>	<p>4. PRA for the system</p>
<p>5. Definition of analytical tools</p>	<p>5. Validation of analytical tools</p>
<p>6. Preconceptual design and analysis of safety features</p>	<p>6. Demonstration of safety features through testing, analysis, or relevant experience</p>
<p>7. Simplified preliminary environmental impact statement for the system</p>	<p>7. Environmental impact statement for the system</p>
<p>8. Preliminary safeguards and physical protection strategy</p>	<p>8. Safeguards and physical protection strategy for system, including cost estimate for extrinsic features</p>
<p>9. Consultation(s) with regulatory agency on safety approach and framework issues</p>	<p>9. Pre-application meeting(s) with regulatory agency</p>

System	Viability Phase Decisions	Date
<i>GFR</i>	<ul style="list-style-type: none"> Fuel down-selection (GFR 1) Core structural materials down-selection (GFR 2) Safety concept specification (GFR 3) Fuel recycle viability (GFR 4) Structural material final selection (GFR 5) 	2010 2010 2010 2012 2012
<i>LFR</i>	<ul style="list-style-type: none"> Structural material selection (550°C outlet temperature) (LFR 1) Nitride fuel fabrication method (LFR 2) Feasibility of transportable reactor/core cartridge (LFR 3) Feasibility/selection of structural material for 800°C Pb (LFR 5) Nitride fuel recycle method (LFR 4) Adequacy of nitride fuel performance potential (LFR 6) Ca-Br hydrogen production process (LFR 7) Supercritical CO₂ Brayton cycle (LFR 8) 	2007 2010 2010 2012 2014 2014 2014 2014
<i>MSR</i>	<ul style="list-style-type: none"> Core materials selection (MSR 1) Fuel salt selection (MSR 2) Power cycle (with tritium control) (MSR 3) Fuel treatment (fission product removal) approach (MSR 4) Noble metal management (MSR 5) Viability of materials (MSR 6) 	2006 2007 2009 2012 2012 2013
<i>SFR</i>	<ul style="list-style-type: none"> Oxide fuel remote fabrication technology selection (SFR 1) 	2006
<i>SCWR</i>	<ul style="list-style-type: none"> Safety approach specification (SC 1) Core structural material down-selection (SC 2) Core structural material final selection (SC 3) Advanced aqueous process application to recycle (SC 4) Fuel/cladding system viability (SC 5) 	2008 2011 2014 2014 2014
<i>VHTR</i>	<ul style="list-style-type: none"> High temperature helium turbine (VH 1) Reactor/hydrogen production process coupling approach (VH 2) Identification of targeted operating temperature (VH 3) Fuel coating material and design concept (VH 4) Adequacy of fuel performance potential (VH 6) Reactor structural material selection (VH 5) 	2008 2010 2010 2010 2010 2010

Crosscut	Viability Phase Decisions	Date
<i>Fuel Cycle</i>	<ul style="list-style-type: none"> Adequacy of actinide recovery fraction (advanced aqueous) (FC 1) Pyroprocess recycle for LWR spent fuel (FC 2) Adequacy of actinide recovery fraction (pyroprocess) (FC 3) Recommendation on separate management of Cs, Sr (FC 4) Integrated management of once-through cycle (FC 5) Group extraction of actinides in aqueous process (FC 6) 	2006 2006 2006 2007 2007 2010
<i>Fuels and Materials</i>	<ul style="list-style-type: none"> Requirements for irradiation and transient test facilities (FM 1) 	2005
<i>Energy Products</i>	<ul style="list-style-type: none"> Requirements for hydrogen production (EP 1) Hydrogen thermochemical production demonstration (EP 2) 	2006 2011
<i>Economics</i>	<ul style="list-style-type: none"> Viability of modular fabrication and installation technologies (EC 1) 	2008

Performance Phase

The performance phase R&D activities undertake the development of performance data and optimization of the system. The table to the right summarizes the key technology issues for each system. Milestones and dates need to be developed based on the viability phase experience. As in the viability phase, periodic evaluations of the system progress relative to its goals will determine if the system development is to continue. The viability and performance phases will likely overlap because some of the performance R&D activities may have long lead times that require their initiation as early as possible.

Demonstration Phase

Assuming the successful completion of viability and performance R&D, a demonstration phase of at least six years is anticipated for each system, requiring funding of several billion U.S. dollars. This phase involves the licensing construction and operation of a prototype or demonstration system in partnership with industry and perhaps other countries. The detailed design and licensing of the system will be performed during this phase.

Comparison of R&D Timelines

An R&D timeline has been defined for each Generation IV system and crosscutting area. The more detailed Level 3 timelines are presented in the recommended R&D section for each of them.

A summary of all (less detailed) Level 2 timelines for the six Generation IV systems is assembled and shown in the figures to the right for comparison of the overall set. Each timeline identifies the viability and performance R&D and the cost for each Level 2 task. The timeline for the crosscutting R&D is shown in the figures on page 83. The choice of the particular systems and the availability of resources and partners will affect the actual timeline that is assembled for a Generation IV program.

Program Implementation

The roadmap will be implemented in an international framework, with participation by the GIF countries. The GIF is discussing options on the organization and conduct of its programs. Participation by specialists or facilities in other countries is desirable.

The GIF expects to implement a set of cooperative agreements under which multiple countries can participate in research projects. The cooperative agreements

System	Prioritized Performance Phase R&D Issues
GFR	<ul style="list-style-type: none"> • Fuel and materials performance • Safety performance • Recycle performance • Economics performance • Balance-of-plant performance
LFR	<ul style="list-style-type: none"> • Fuel and materials performance • Recycle performance • Economics performance • Balance-of-plant performance • Safety performance • Inspection and maintenance methods
MSR	<ul style="list-style-type: none"> • Fuel treatment performance • Balance-of-plant performance • Safety performance • Materials performance • Reliability performance • Economics performance • Inspection and maintenance methods
SFR	<ul style="list-style-type: none"> • Economics performance • Recycle performance at scale • Passive safety confirmation
SCWR	<ul style="list-style-type: none"> • Fuels and materials performance • Safety performance • Economics performance • Recycle performance
VHTR	<ul style="list-style-type: none"> • Fuels and materials performance • Economics performance • Safety performance • Balance-of-plant performance

will establish the work scope, obligations, intellectual property rights, dispute resolution, amendments, and other necessary items. For each Generation IV system or crosscut, multiple projects may be defined. For example, development of fuel may constitute a single project. This structure will allow considerable flexibility in defining each country's participation, which is consistent with the GIF charter. The GIF has an Experts Group that is chartered to oversee and report on programs annually.

Integration Issues and Opportunities

The assembly of programs and projects, and the implementation of international collaborations to execute them is the central approach to program integration. In addition, there are several important issues that have been identified during the roadmap process. Each presents an opportunity to more effectively advance a Generation IV program.

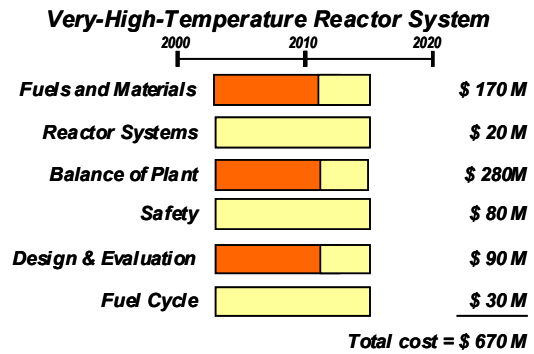
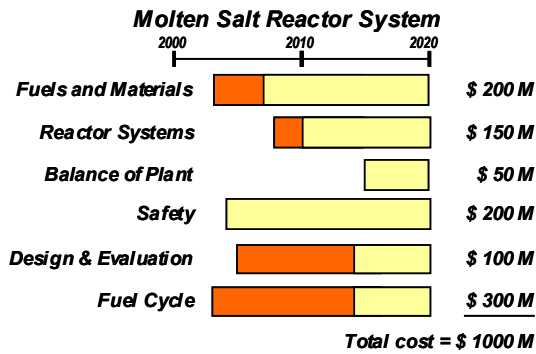
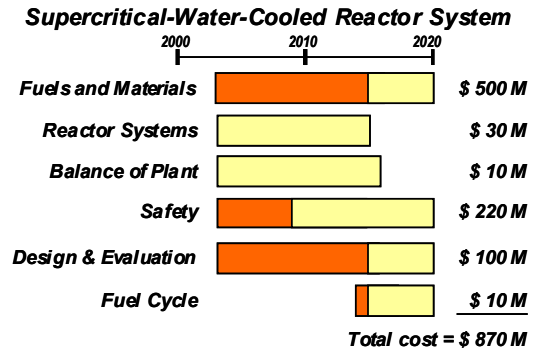
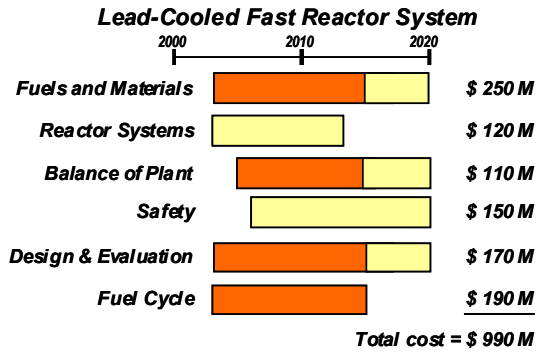
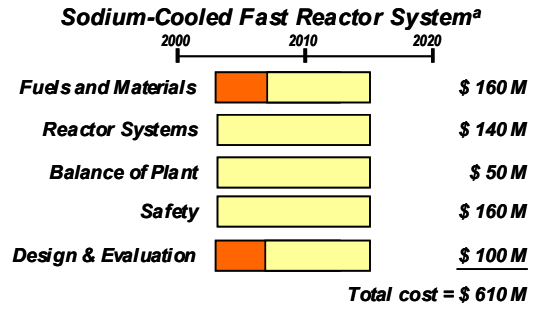
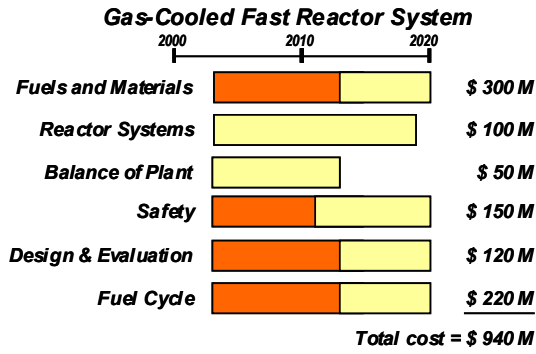

Viability Performance

a. Fuel Cycle R&D for the SFR is entirely contained in the Fuel Cycle Crosscut R&D.

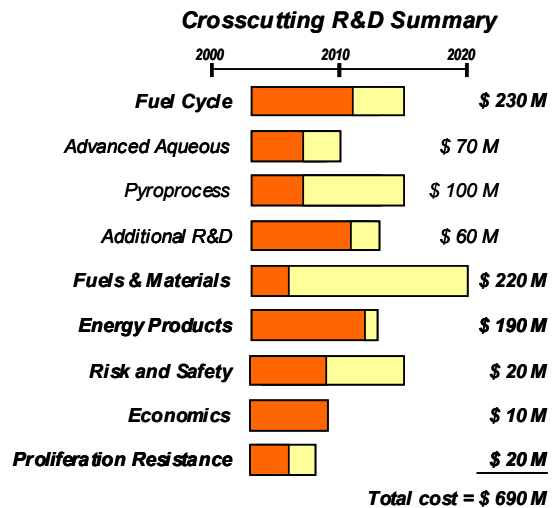

Communications and Stakeholder Feedback

While technical advances in Generation IV will contribute to increased public confidence, the degree of openness and transparency in program execution may be even more important. Accordingly, the findings of this roadmap and R&D plans based on it will be communicated to the public on a continuing basis. Moreover, mechanisms for communicating with interested stakeholder groups should be developed so that their views and feedback on the program are considered and, to the extent possible, incorporated into the objectives of the R&D program.

Infrastructure Development and Use

Given the need for substantial R&D on fuel cycles, fuels and materials, and system conceptual design and analysis, it is apparent that existing worldwide infrastructure may not be sufficient to accomplish the objectives. An opportunity exists to plan for the shared use of existing infrastructure, and to undertake the development of new infrastructure. This is most apparent in the areas of fuel recycle and refabrication, and fuel and materials irradiation and test facilities. Other technology areas may deserve attention. In addition, the coordinated use of existing facilities may offer opportunities, where for example, irradiation campaigns that support the survey of candidate fuels and materials may be able to share facility space and reduce costs.

Coordinated Licensing Approaches

Interaction with individual regulatory authorities by the R&D programs is essential while the system designs progress. Such interactions enable the early identification and resolution of potential licensing issues, because they allow the regulator to understand the system design features and technologies and provide feedback. Given the emphasis in the Generation IV initiative to enable system deployment in larger regions or multiple countries, the opportunity exists for expanding the interactions. Beyond this, however, there may be significant opportunity to seek coordinated licensing approaches between the authorities. This would be advanced by interactions of a number of authorities who take up the objective of exploring a common licensing framework for Generation IV systems.

Institutional Barriers and Development

Some of the Generation IV systems propose deployment of regional front and back end fuel cycle facilities, and others propose factory fabrication of modules on a large scale, or connection to future hydrogen supply infrastructures. In the first case, institutional developments are needed for regional fuel cycle centers owned by a consortium of clients and operating under international safeguards oversight. In the other cases, the exploration of barriers and institutional development will present opportunities for improvement.

Technology Development Interactions with Nearer-Term Systems

The interaction of Generation IV R&D and nearer-term developments such as the U.S. NTD and the INTD will be beneficial. Near-term development of technology may offer significant reduction in research needs for Generation IV systems while expanding the potential market for the developers of a technology. On the other hand, R&D on Generation IV systems may offer significant new innovations that could be adopted by nearer-term systems. These benefits point out the opportunity for the development for collaborations with industry, and for the coordination of these efforts.

R&D Pathways

Many opportunities are apparent in Generation IV R&D to sequence the work on its technologies (such as fuels or fuel cycles) or even entire systems or system options. Some of this has been exploited in the roadmap to this point. For example, fuel recycle R&D is on the critical path for the SFR and is likely to be first advanced in that area. Other systems anticipate this development, and their fuel recycle R&D is focused on the specialization of front and back end processes that couple with technology developed for the SFR. Examples are plentiful in the fuels and materials area, where for example, the development of nitride fuels by one system will open options for several others. With the need to have flexibility in program choices and collaborations, however, there has not been a systematic examination of such pathways. An opportunity exists as the programs and projects are defined to explore pathways that offer efficiencies and innovation.

ROADMAP

MEMBERS OF THE GENERATION IV ROADMAP PROJECT

Generation IV Roadmap NERAC Subcommittee (GRNS)

Bobby Abrams^f
Duke Engineering

Douglas Chapin
MPR Associates

B. John Garrick
Independent Consultant

Daniel Kammen
University of California–Berkeley

Salomon Levy^g
Levy & Associates

Ted Marston
Electrical Power Research Institute

William Naughton
Exelon

Neil Todreas^g
Massachusetts Institute of Technology

Roadmap Integration Team (RIT)

Todd Allen
Argonne National Laboratory

Ralph Bennett^g
Idaho National Engineering and Environmental Laboratory

Gian Luigi Fiorini
Commissariat à l’Energie Atomique

Hussein Khalil^g
Argonne National Laboratory

John Kotek
Argonne National Laboratory

John M. Ryskamp
Idaho National Engineering and Environmental Laboratory

Rob Versluis
Department of Energy – Nuclear Energy

Technical Working Group 1 – Water Cooled

Mario Carelli
Westinghouse

John Cleveland
International Atomic Energy Agency

Michael L. Corradini
University of Wisconsin

Wolfgang Daeuwel
European Commission-Framatome

Darío Delmastro
Comisión Nacional de Energía Atómica

John C. (Jack) Devine, Jr.^g
Polestar

David J. Diamond
Brookhaven National Laboratory

Kenneth R. Hedges^g
Atomic Energy of Canada Limited

Kazuyoshi Kataoka
Toshiba

Philippe Lauret
Framatome - ANP

Yoon Young Lee
Doosan Heavy Industries & Construction Company

Philip E. MacDonald^g
Idaho National Engineering and Environmental Laboratory

Yoshiaki Oka
University of Tokyo

Akira Omoto
Tokyo Electric Power Company

Jong Kyun Park
Korea Atomic Energy Research Institute

Noval A. Smith, Jr.
Dominion Virginia Power Company

Antonio Teixeira e Silva
IPEN/CNEN/SP

Alfredo Vasile
Commissariat à l’Energie Atomique

Gary S. Was
University of Michigan

George Yadigaroglu
Swiss Federal Institute of Technology - Zurich

^fResigned July 2002

^gCo-chair or Technical Director

Technical Working Group 2 - Gas Cooled

Timothy Abram

British Nuclear Fuels Limited

Sydney Ball

Oak Ridge National Laboratory

Bernard Ballot

Framatome - ANP

Arden Bement

National Institute of Standards and Technology

Franck Carre[§]

Commissariat à l'Énergie Atomique

Phillip Finck

Argonne National Laboratory

Konstantin Foskolos

Paul Scherrer Institute

Kosaku Fukuda

International Atomic Energy Agency

Marco Gasparini

International Atomic Energy Agency

Dominique Greneche

COGEMA

Phil Hildebrandt[§]

Engineering, Management and Technology, Inc.

Andrew C. Kadak

Massachusetts Institute of Technology

Shin Whan Kim

Korea Power Engineering Company

Werner von Lensa

European Commission/FZJ Juelich

David Moses

Oak Ridge National Laboratory

Masuro Ogawa

Japan Atomic Energy Research Institute

Jacques RoyenOrganisation for Economic Co-operation and
Development-Nuclear Energy Agency**Arkal Shenoy**

General Atomics

Finis Southworth[§]

Idaho National Engineering and Environmental Laboratory

Technical Working Group 3 – Metal Cooled

Gerhard Bart

Paul Scherrer Institut

Charles Boardman

Consultant

Jean-Louis Carbonnier

Commissariat à l'Énergie Atomique

Luciano Cinotti

European Commission-Ansaldo

Jean-Paul GlatzEuropean Commission, Centre Commum de Recherch,
Karlsruhe**Orlando J.A. Gonçalves Filho**

Instituto de Engenharia Nuclear/CNEN

Masakazu Ichimiya

Japan Nuclear Cycle Development Institute

John Lee

University of Michigan

Ning Li

Los Alamos National Laboratory

Michael Lineberry[§]

Argonne National Laboratory

Claes NordborgOrganisation for Economic Co-operation and Development
– Nuclear Energy Agency**Ron Omberg**

Pacific Northwest National Laboratory

Stephen Rosen[§]

Consultant

Yutaka Sagayama[§]

Japan Nuclear Cycle Development Institute

Alexander Stanculescu

International Atomic Energy Agency

Do Hee Hahn

Korea Atomic Energy Research Institute

Kune Y. Suh

Seoul National University

Jack Tuohy

Burns & Roe

David Wade

Argonne National Laboratory

[§]Co-chair or Technical Director

Technical Working Group 4 – Non-classical

Samim Anghaie[§]

University of Florida

Marc Delpech

Commissariat à l’Energie Atomique

Charles Forsberg

Oak Ridge National Laboratory

Claude Garzenne

Electricité de France

J. Stephen Herring

Idaho National Engineering and Environmental Laboratory

Andrew Klein

Oregon State University

Tom Lennox

NNC Limited

Maurice Leroy

European Commission, Joint Research Center, Karlsruhe

David Lewis[§]

Argonne National Laboratory

Won Seok Park

Korea Atomic Energy Research Institute

K. Lee Peddicord

Texas A&M

Paul Pickard

Sandia National Laboratory

Hideki Takano

Japan Atomic Energy Research Institute

Paul Wilson

University of Wisconsin

Economics Crosscut Group (ECG)

Evelyne Bertel[§]Organisation for Economic Co-operation and Development
– Nuclear Energy Agency**Chaim Braun**

Altos Management

Luciano Cinotti

EC-Ansaldo

Michael L. Corradini[§]

University of Wisconsin

Kenneth R. Hedges

Atomic Energy of Canada Limited

Andrew C. Kadak

Massachusetts Institute of Technology

Philippe Lauret

Framatome –ANP

Tom Lennox

NNC Limited

Keith Miller

British Nuclear Fuels

Geoffrey Rothwell[§]

Stanford University

Jacques Rouault

Commissariat à l’Energie Atomique

Yutaka Sagayama

Japan Nuclear Cycle Development Institute

Finis Southworth

Idaho National Engineering and Environmental Laboratory

Jack Tuohy

Burns & Roe

Energy Products Crosscut Group (EPCG)

Michael Golay

Massachusetts Institute of Technology

J. Stephen Herring

Idaho National Engineering and Environmental Laboratory

Andrew Klein[§]

Oregon State University

David Lewis

Argonne National Laboratory

Michael Lineberry

Argonne National Laboratory

Masuro Ogawa[§]

Japan Atomic Energy Research Institute

K. Lee Peddicord[§]

Texas A&M

Arkal Shenoy

General Atomics

Alfredo Vasile

Commissariat à l’Energie Atomique

Werner von Lensa

European Commission/FZJ Jülich

[§]Co-chair or Technical Director

Evaluation Methodology Group (EMG)

Deborah Bennett

Los Alamos National Laboratory

Evelyne BertelOrganisation for Economic Co-operation and Development
– Nuclear Energy Agency**Dennis Bley**

Buttonwood Consulting

Douglas Crawford

Argonne National Laboratory

Brent Dixon

Idaho National Engineering and Environmental Laboratory

Michael Golay

Massachusetts Institute of Technology

William Halsey

Lawrence Livermore National Laboratory

Kazuaki Matsui

Institute of Applied Energy

Keith Miller

British Nuclear Fuels

Per Peterson

University of California-Berkeley

Bill Rasin[§]

Consultant

Jordi Roglans[§]

Argonne National Laboratory

Geoffrey Rothwell

Stanford University

Thomas Shea

International Atomic Energy Agency

Michel Vidard

Electricité de France

Jean-Claude Yazidjian

Framatome – ANP

Fuel Cycle Crosscut Group (FCCG)

Arden Bement

National Institute of Standards and Technology

Charles Boardman

Consultant

Bernard Boullis

Commissariat à l'Énergie Atomique

Rakesh Chawla

Paul Scherrer Institut

Doug Crawford

Argonne National Laboratory

Charles Forsberg[§]

Oak Ridge National Laboratory

Kosaku Fukuda

International Atomic Energy Agency

Jean-Paul Glatz

European Commission, Joint Research Center, Karlsruhe

Dominique Greneche

COGEMA

William Halsey

Lawrence Livermore National Laboratory

J. Stephen Herring

Idaho National Engineering and Environmental Laboratory

Maurice Leroy

European Commission, Joint Research Center, Karlsruhe

David Lewis

Argonne National Laboratory

Hiroshi Noda

Japan Nuclear Cycle Development Institute

Per Peterson

University of California-Berkeley

Luc van den DurpelOrganisation for Economic Co-operation and Development
– Nuclear Energy Agency**David Wade[§]**

Argonne National Laboratory

Myung Seung Yang

Korea Atomic Energy Research Institute

[§]Co-chair or Technical Director

Fuels and Materials Crosscut Group (FMCG)

Tim Abram[§] British Nuclear Fuels	Philip E. MacDonald Idaho National Engineering and Environmental Laboratory
Gerhard Bart Paul Scherrer Institute	Phillippe Martin Commissariat à l’Energie Atomique
Douglas Crawford[§] Argonne National Laboratory	David Moses Oak Ridge National Laboratory
Wolfgang Daeuwel European Commission-Framatome	Claes Nordborg Organisation for Economic Co-operation and Development – Nuclear Energy Agency
Claude Garzenne Electricité de France	Won Seok Park Korea Atomic Energy Research Institute
Masakazu Ichimiya Japan Nuclear Cycle Development Institute	Gary S. Was University of Michigan
Ning Li Argonne National Laboratory	

Risk and Safety Crosscut Group (RSCG)

Sydney Ball Oak Ridge National Laboratory	Marco Gasparini International Atomic Energy Agency
Bernard Ballot Framatome - ANP	Kazuyoshi Kataoka Toshiba
Jeff Binder Argonne National Laboratory	Per Peterson[§] University of California-Berkeley
Dennis Bley Buttonwood	Paul Pickard[§] Sandia National Laboratory
Charles Boardman Consultant	Stephen Rosen Consultant
Mario Carelli Westinghouse	Jacques Royen Organisation for Economic Co-operation and Development-Nuclear Energy Agency
Marc Delpech[§] Commissariat à l’Energie Atomique	Kune Y. Suh Seoul National University

Additional Contributors

Paul Bayless Idaho National Engineering and Environmental Laboratory	Hubert Ley Argonne National Laboratory
Jacopo Buongiorno Idaho National Engineering and Environmental Laboratory	Luis Nunez Argonne National Laboratory
Burrus Carnahan U.S. Department of State	Carter D. Savage Department of Energy
Madeline A. Feltus Department of Energy	Richard Schultz Idaho National Engineering and Environmental Laboratory
Robert Gottschall Department of Energy	Steven Sorrell Department of Energy
Jim Kendall International Atomic Energy Agency	

[§]Co-chair or Technical Director

ACRONYMS

ABWR	Advanced Boiling Water Reactor	FCCG	Fuel Cycle Crosscut Group
ABWR II	Advanced Boiling Water Reactor II	FIMA	fissions of initial metal atoms
AIROX	Atomics International Reduction Oxidation Process	F-M	ferritic-martensitic stainless steels
ALMR	Advanced Liquid Metal Reactor	FP	fission product
ALWR	Advanced Light Water Reactor	GFR	Gas-Cooled Fast Reactor
AP1000	Advanced Pressurized Water Reactor 1000	GIF	Generation IV International Forum
AP600	Advanced Pressurized Water Reactor 600	GT-MHR	Gas Turbine – Modular High-Temperature Reactor
APR1400	Advanced Power Reactor 1400	GWD/MTHM	gigawatt-days/metric tonne heavy metal
APWR+	Advanced Pressurized Water Reactor Plus	HC-BWR	High-Conversion Boiling Water Reactor
ARE	Aircraft Reactor Experiment (U.S.)	HLW	high-level waste
AVR	Arbeitsgemeinschaft Versuchsreaktor (Germany)	HTGR	High-Temperature Gas Reactor
BWR	Boiling Water Reactor	HTR-10	High-Temperature Reactor 10 (China)
CANDU	Canada Deuterium Uranium, Reactor	HTTR	High-Temperature Engineering Test Reactor (Japan)
CAREM	Central Argentina de Elementos Modulares	HX	heat exchanger
CR	control rod	IAEA	International Atomic Energy Agency
CSAU	Code Scaling, Applicability, and Uncertainty Method	IHX	intermediate heat exchanger
DBTT	ductile-brittle transition temperature	IMR	International Modular Reactor
DF	decontamination factor	INTD	International Near-Term Deployment
DHR	decay heat removal	IRIS	International Reactor Innovative and Secure
DOE	Department of Energy (U.S.)	I-S	iodine-sulfur process
dpa	displacements per atom	ISIR	in-service inspection and repair
EBR-I	Experimental Breeder Reactor I (U.S.)	LEU	low enriched uranium
EBR-II	Experimental Breeder Reactor II (U.S.)	LFR	Lead-Cooled Fast Reactor
EC	Economics (Generation IV goal area)	LMR	Liquid Metal-Cooled Reactor
EPR	European Pressurized Water Reactor	LOCA	loss of coolant accident
ESBWR	European Simplified Boiling Water Reactor	LWR	Light Water Reactor
		MA	minor actinides
		MC	(U,Pu)C metal carbide fuel form
		MHTGR	Modular High Temperature Gas-Cooled Reactor

MN	(U,Pu)N metal nitride fuel form	RBMK	Reactor Bolshoi Moshchnosti Kanalnyi
MOX	(U,Pu)O ₂ mixed oxide fuel		
MPa	megapascals	RCS	reactor coolant system
MPC&A	material protection, control, and accountability	REDOX	electrochemical reduction- oxidation
MSR	Molten Salt Reactor	RIA	reactivity-insertion accident
MSRE	Molten Salt Reactor Experiment (U.S.)	RPV	reactor pressure vessel
MTHM	metric tonnes heavy metal	SC	supercritical
MTU	metric tonnes uranium	SCC	stress corrosion cracking
MWe	megawatts electrical	SCLWR	Supercritical Light Water Reactor
MWth	megawatts thermal	SCW	supercritical water
NEA	Nuclear Energy Agency	SCWR	Supercritical Water-Cooled Reactor
NERAC	Nuclear Energy Research Advisory Committee (U.S.)	SFR	Sodium-Cooled Fast Reactor
NTD	Near-Term Deployment	SG	steam generator
ODS	oxide dispersion-strengthened steels	SMART	System-Integrated Modular Advanced Reactor
OECD	Organisation for Economic Cooperation and Development	SNF	spent nuclear fuel
ORNL	Oak Ridge National Laboratory	S-PRISM	Super-Power Reactor Inherently Safe Module
PBMR	Pebble Bed Modular Reactor	SR	Safety and Reliability (Generation IV goal area)
PIE	postirradiation examination	SU	Sustainability (Generation IV goal area)
PR&PP	Proliferation Resistance and Physical Protection (Generation IV goal area); also PR	SWR-1000	Siedewasser Reactor-1000
PRA	probabilistic risk assessment	THTR	Thorium High-Temperature Reactor (Germany)
PUREX	Plutonium and Uranium Recovery by Extraction	TRU	transuranic elements
PWR	Pressurized Water Reactor	TWG	Technical Working Group
pyro	pyroprocessing	UREX	Uranium Recovery by Extraction
R&D	research and development	VHTR	Very-High-Temperature Reactor