

NASA Contractor Report 3424

NASA  
CR  
3424  
c.1



# Representative Equations for the Thermodynamic and Transport Properties of Fluids Near the Gas-Liquid Critical Point

J. V. Sengers, R. S. Basu,  
and J. M. H. Levelt Sengers

GRANT NGR 21-002-344  
MAY 1981

**NASA**



NASA Contractor Report 3424

# Representative Equations for the Thermodynamic and Transport Properties of Fluids Near the Gas-Liquid Critical Point

J. V. Sengers and R. S. Basu  
*University of Maryland*  
*College Park, Maryland*

J. M. H. Levelt Sengers  
*National Bureau of Standards*  
*Washington, D.C.*

Prepared for  
Lewis Research Center  
under Grant NGR 21-002-344

**NASA**

National Aeronautics  
and Space Administration

**Scientific and Technical  
Information Branch**

1981



## Table of Contents

Nomenclature .....	v
1. Introduction .....	1
2. Equilibrium properties .....	3
2.1 Power laws .....	3
2.2 Scaling laws .....	6
2.3 Equations of state for the critical region .....	9
2.3.1 MLSG equation of state .....	9
2.3.2 Linear model equation of state .....	11
2.4 Universality .....	14
2.5 A fundamental equation for the critical region .....	17
2.6 Correlation length .....	17
3. Transport properties .....	19
3.1 Introductory remarks .....	19
3.2 Thermal conductivity .....	23
3.2.1 Thermal conductivity equation .....	23
3.2.2 Thermal conductivity of carbon dioxide .....	25
3.2.3 Thermal conductivity of steam .....	28
3.3 Viscosity .....	32
3.3.1 Viscosity equation .....	32
3.3.2 Viscosity of nitrogen .....	32
3.3.3 Viscosity of steam .....	34
4. Discussion .....	38
4.1 Recommendations for calculating the thermal conductivity in the critical region .....	38
4.2 Recommendations for calculating the viscosity in the critical region .....	40
4.3 Outlook .....	42
References .....	43
Appendix: Computer program for calculating the linear model parameters r and $\theta$ .....	50



## Nomenclature

- A = Helmholtz free energy.
- $A^*$  =  $A/P_c V$ .
- $A^+$  = power law amplitude for specific heat above  $T_c$  (see Table I).
- $A^-$  = power law amplitude for specific heat below  $T_c$  (see Table I).
- $A_\lambda$  = parameter in eq. (3.13) for crossover function F.
- a = linear model equation of state parameter (see eq. (2.14c)).
- $a(y)$  = scaling function for  $A^*$  (see Table II).
- $a_k^\eta$  = coefficients in eq. (3.33) for  $\eta_0$  of steam.
- $a_k^\lambda$  = coefficients in eqs. (3.18) and (3.23) for  $\lambda_0$  of carbon dioxide and steam.
- B = power law amplitude for coexisting densities (see Table I).
- $B_\lambda$  = parameter in eq. (3.13) for crossover function F.
- b = linear model equation of state constant (see eq. (2.14a)).
- $b_{ij}^\eta$  = coefficients in eq. (3.32) for  $\bar{\eta}$  of steam.
- $b_{ij}^\lambda$  = coefficients in eq. (3.22) for  $\bar{\lambda}$  of steam.
- $C_v$  = heat capacity at constant volume.
- $C_v^*$  =  $C_v T_c / P_c V$ .
- $C_p$  = heat capacity at constant pressure.
- $C_p^*$  =  $C_p T_c / P_c V$ .
- $c_v$  = specific heat at constant volume.
- $c_p$  = specific heat at constant pressure.
- D = power law amplitude for chemical potential at  $T = T_c$  (see Table I).
- $D_T$  =  $\lambda / \rho c_p$  = thermal diffusivity.
- E = constant in MLSG equation of state (see eq. (2.10)).
- F = crossover function in thermal conductivity equation defined by eq. (3.13).
- $h(y)$  = scaling function for  $\mu^*$  (see Table II).

$K_T$	=	$\rho^{-1}(\partial\rho/\partial P)_T$ = compressibility.
$k$	=	linear model equation of state parameter (see eq. (2.14b)).
$k_B$	=	Boltzmann's constant.
$n$	=	exponent in eq. (3.13) for crossover function F.
$P$	=	pressure.
$P_c$	=	critical pressure.
$P^*$	=	$P/P_c$ .
$P_o^*(T^*)$	=	analytic background in the equation for the pressure in the critical region (see Table II).
$P_i^*$	=	coefficients in eq. (2.17) for $P_o^*(T^*)$ .
$p(\theta)$	=	auxiliary function in linear model equation of state (see Table III).
$p_i$	=	coefficients in equation for $p(\theta)$ (see Table III).
$q$	=	parameter in eq. (3.27) for critical viscosity enhancement.
$R$	=	universal constant in eq. (2.21) for $\xi_o$ .
$r$	=	parametric variable in linear model equation of state (see eq. (2.14)).
$S$	=	entropy.
$S^*$	=	$ST_c/P_c V$ .
$s(\theta)$	=	auxiliary function in linear model equation of state (see Table III).
$s'(\theta)$	=	$ds(\theta)/d\theta$ .
$s_i$	=	coefficients in equation for $s(\theta)$ (see Table III).
$T$	=	temperature.
$T_c$	=	critical temperature.
$T^*$	=	$T/T_c$ .
$\Delta T^*$	=	$(T-T_c)/T_c$ .
$T_r$	=	reference temperature (see eqs. (3.20) and (3.25)).
$\bar{T}$	=	$T/T_r$ .

$V$	= volume.
$x$	= $\Delta T^*/ \Delta\rho^* ^{1/\beta}$ .
$x_0$	= $-x$ at coexistence curve.
$y$	= $(x+x_0)/x_0$ .
$\alpha$	= power law exponent for specific heat (see Table I).
$\beta$	= power law exponent for coexisting densities (see Table I).
$\Gamma$	= power law amplitude for compressibility above $T_c$ (see Table I).
$\Gamma'$	= power law amplitude for compressibility below $T_c$ (see Table I).
$\gamma$	= power law exponent for compressibility (see Table I).
$\delta$	= power law exponent for chemical potential at $T=T_c$ (see Table I).
$\eta$	= shear viscosity.
$\eta_0$	= $\lim_{\rho \rightarrow 0} \eta$ .
$\eta_e$	= excess viscosity.
$\bar{\eta}$	= normal viscosity.
$\Delta\eta$	= critical viscosity enhancement.
$\theta$	= parametric variable in linear model equation of state (see eq. (2.14)).
$\xi$	= correlation length.
$\xi_0$	= power law amplitude for correlation length above $T_c$ (see Table I).
$\xi'_0$	= power law amplitude for correlation length below $T_c$ (see Table I).
$\Xi_0$	= $\xi_0/\Gamma^{\nu/\gamma}$ .
$\Lambda$	= constant in eq. (3.11) for critical thermal conductivity enhancement.
$\lambda$	= thermal conductivity.
$\lambda_0$	= $\lim_{\rho \rightarrow 0} \lambda$ .
$\lambda_e$	= excess thermal conductivity.
$\bar{\lambda}$	= normal thermal conductivity.
$\Delta\lambda$	= critical thermal conductivity enhancement.
$\lambda_i$	= coefficients in eq. (3.17) for $\bar{\lambda}_i$ of carbon dioxide.



$\mu$	=	chemical potential.
$\mu^*$	=	$\mu\rho_c/P_c$ .
$\Delta\mu^*$	=	$\{\mu(\rho,T) - \mu(\rho_c,T)\}\rho_c/P_c$ .
$\mu_c^*$	=	value of $\mu^*$ at critical point.
$\mu_o^*(T^*)$	=	analytic background in the equation for the chemical potential in the critical region (see Table II).
$\mu_i^*$	=	coefficients in eq. (2.19) for $\mu_o^*(T^*)$ .
$\nu$	=	power law exponent for correlation length (see Table I).
$\rho$	=	density.
$\rho_c$	=	critical density.
$\rho^*$	=	$\rho/\rho_c$ .
$\Delta\rho^*$	=	$(\rho-\rho_c)/\rho_c$ .
$\rho_r$	=	reference temperature (see eqs. (3.20) and (3.25)).
$\bar{\rho}$	=	$\rho/\rho_r$ .
$\phi$	=	exponent in eq. (3.27) for critical viscosity enhancement.
$\chi_T$	=	$\rho^2 K_T$ .
$\chi_T^*$	=	$\chi_T P_c / \rho_c^2$ .
$\chi_o^*$	=	$\Gamma / (q\xi_o)^\gamma / \nu$ .

## 1. Introduction

Many thermophysical properties exhibit a singular behavior in the vicinity of the critical point. For instance, the isothermal compressibility, the thermal expansion coefficient and the specific heat of fluids all diverge at the critical point. Critical enhancement effects are also encountered in the behavior of the thermal conductivity and the viscosity near the critical point. It has always been difficult to formulate correlating equations that incorporate accurately the singular behavior of the various thermophysical properties near the critical point. However, in recent years considerable progress has been made in the art of developing representative equations for the thermodynamic and transport properties of fluids in the critical region. The purpose of this technical report is to discuss these developments with an emphasis on practical applications.

The critical point is a point of marginal thermodynamic stability. In the vicinity of the critical point, large-scale density fluctuations are present in the fluid. The spatial extent of these fluctuations can be characterized by a correlation length  $\xi$ . Near the critical point, this correlation length becomes much larger than the intermolecular interaction range. One can imagine that the critical enhancement effects are caused by the static and dynamic behavior of a system of clusters. Different states in the vicinity of the critical point correspond to different cluster sizes and the thermodynamic states can be interrelated by scaling laws. Moreover the properties of a system of clusters become independent of the nature of the individual molecules. This principle is commonly referred to as critical-point universality (Levelt Sengers et al., 1977).

Recent developments have revealed that the simple scaling laws for the critical behavior of the thermodynamic properties become rigorously valid only in an asymptotically small region around the critical point, a region too small to be of interest in engineering applications. In order to formulate representations of the thermophysical properties that can be used in a larger range around the critical point one has two options. The first option, the more fundamental one, is to develop a theory for the higher order corrections to the asymptotic scaling laws. This approach is currently being developed (Levelt Sengers and Sengers, 1980). The other approach is to modify the asymptotic scaling laws using some semi-empirical adaptations. It is the latter approach which will be followed in this technical report. Hence, the emphasis is not on a test of the validity of the modern theory of critical phenomena, but rather on a presentation of some simplified procedures that enable one to characterize the behavior of the thermophysical properties of fluids in the critical region with reasonable accuracy.

A comprehensive account of methods for describing equilibrium properties of fluids was presented in a previous NASA contractor report (Sengers and Levelt Sengers, 1977). The primary purpose of the present report is to ex-

tend the methods to a description of the transport properties of fluids in the critical region. However, the behavior of the transport properties near the critical point is closely related to the critical behavior of the thermodynamic properties and the correlation length. For this reason, it was deemed desirable to include in this report a brief review of the behavior of the equilibrium properties in the critical region as well.

There exists a close analogy between the behavior of the thermodynamic and transport properties of fluids near the gas-liquid critical point and those of binary liquids near the critical mixing point (Sengers and Levelt Sengers, 1977; Scott, 1978; Greer, 1978). This technical report deals only with the behavior of the properties of one-component fluids near the gas-liquid critical point.

The part of this report concerned with the equation of state is based on research done in collaboration with the late T. A. Murphy. Representative equations for the thermophysical properties of carbon dioxide were formulated in collaboration with F. J. Cook and equations for the transport properties of steam in collaboration with J. T. R. Watson.

Computer time for this project was provided by the Computer Science Center at the University of Maryland.

## 2. Equilibrium properties

### 2.1 Power laws

Let  $A$  be the Helmholtz free energy,  $S$  the entropy,  $\mu$  the chemical potential per unit mass,  $C_V$  the heat capacity at constant volume and  $C_P$  the heat capacity at constant pressure. We also find it convenient to introduce a symmetrized isothermal compressibility defined as

$$\chi_T \equiv \left( \frac{\partial \rho}{\partial \mu} \right)_T = \rho^2 K_T \quad . \quad (2.1)$$

The thermodynamic properties are made dimensionless by expressing them in terms of the critical temperature  $T_c$ , the critical density  $\rho_c$  and the critical pressure  $P_c$ .

$$T^* = T/T_c \quad , \quad \rho^* = \rho/\rho_c \quad , \quad P^* = P/P_c \quad , \quad A^* = A/P_c V \quad , \quad \mu^* = \mu \rho_c / P_c \quad ,$$

$$\chi_T^* = \chi_T P_c / \rho_c^2 \quad , \quad S^* = S T_c / P_c V \quad , \quad C_V^* = C_V T_c / P_c V \quad , \quad C_P^* = C_P T_c / P_c V \quad . \quad (2.2)$$

Note that the reduced extensive properties  $A^*$ ,  $S^*$  and  $C^*$  are all taken per unit volume, rather than per unit mass. The reason is that the singular part of the extensive thermodynamic properties per unit volume appear to be approximately symmetric or antisymmetric functions of  $\rho - \rho_c$  (Vicentini-Missoni et al., 1969a; Levelt Sengers, 1974). As a consequence,  $\chi_T$  is also a symmetric function of  $\rho - \rho_c$ , while the compressibility  $K_T \equiv \rho^{-1} (\partial \rho / \partial P)_T$  is not (Sengers, 1973). We also define the reduced differences

$$\begin{aligned} \Delta T^* &= (T - T_c) / T_c \quad , \\ \Delta \rho^* &= (\rho - \rho_c) / \rho_c \quad , \\ \Delta \mu^* &= [\mu(\rho, T) - \mu(\rho_c, T)] \rho_c / P_c \quad . \end{aligned} \quad (2.3)$$

To represent the singular thermodynamic behavior of fluids in the vicinity of the critical point, one first defines critical power laws. The exponents of these power laws depend on the property considered and the path along which the critical point is approached. The special paths in the  $\Delta T^* - \Delta \rho^*$  plane commonly considered are the coexistence curve or phase boundary (CXC), the critical isochore (CIC)  $\Delta \rho^* = 0$  and the critical isotherm (CIT)  $\Delta T^* = 0$ . These paths are indicated schematically in Fig. 1. The critical power laws defined along these paths are summarized in Table I. The critical exponents of the different thermodynamic properties are not independent. The scaling laws to be discussed below imply the exponent relations

$$\alpha = 2 - \beta(\delta + 1) \quad , \quad \gamma = \beta(\delta - 1) \quad . \quad (2.4)$$

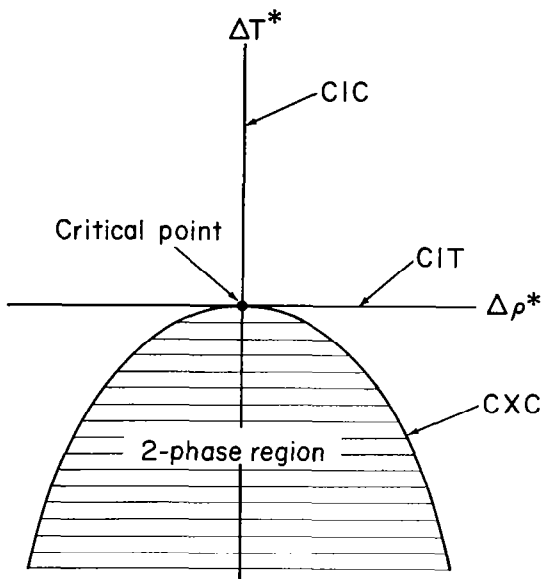

Fig. 1 Special paths in the  $\Delta T^*$  versus  $\Delta \rho^*$  plane for the definition of critical power laws.

Table I Critical power laws

Property	Path	Power law
$C_V^*/T^*$	CIC , $\Delta T^* \geq 0$	$\frac{A^+}{\alpha}  \Delta T^* ^{-\alpha}$
$C_V^*/T^*$	CIC , $\Delta T^* \leq 0$	$\frac{A^-}{\alpha}  \Delta T^* ^{-\alpha}$
$\Delta\rho^*$	CXC	$\pm B  \Delta T^* ^\beta$
$\chi_T^*$	CIC , $\Delta T^* \geq 0$	$\Gamma  \Delta T^* ^{-\gamma}$
$\chi_T^*$	CXC	$\Gamma'  \Delta T^* ^{-\gamma}$
$\Delta\mu^*$	CIT	$\pm D  \Delta\rho^* ^\delta$
$\xi$	CIC , $\Delta T^* \geq 0$	$\xi_0  \Delta T^* ^{-\nu}$
$\xi$	CXC	$\xi'_0  \Delta T^* ^{-\nu}$

It is generally believed that the critical exponents of fluids should be the same as those of spin systems represented by a Landau-Ginzburg Hamiltonian (Hubbard and Schofield, 1972; Nicoll, 1980). These critical exponent values have been calculated with considerable accuracy (Baker et al., 1978; Le Guillou and Zinn-Justin, 1977, 1980). Experiments indicate agreement with these theoretical exponent values provided that the temperature of the gas-liquid critical point is approached to within a few hundredths of a percent (Levelt Sengers et al., 1977). Efforts to develop a systematic theoretical description of the thermodynamic behavior over a larger range of temperatures and densities are currently in progress (Ley-Koo and Green, 1977; De Pasquale et al., 1978; Nicoll and Chang, 1978; Levelt Sengers and Sengers, 1980). Here we continue to employ a more practical approach, adopted in the previous technical report, by

using the critical power laws over a larger range with effective exponent values deduced from the experimental data (Levelt Sengers and Sengers, 1975; Levelt Sengers et al., 1976; Sengers and Levelt Sengers, 1977; Aharony and Ahlers, 1980).

## 2.2 Scaling laws

The critical power laws characterize the behavior of the thermodynamic properties along selected paths in the  $\Delta T^* - \Delta \rho^*$  plane. We can generalize the description to the behavior of the thermodynamic properties at arbitrary temperatures and densities in the critical region by formulating scaling laws. For this purpose one defines a scaling variable  $x$  as

$$x = \Delta T^* / |\Delta \rho^*|^{1/\beta} , \quad (2.5)$$

This scaling variable is chosen such that the coexistence boundary corresponds to a constant value of the scaling variable  $x$ :

$$x_{cxc} = -x_0 , \quad x_0 = B^{-1/\beta} . \quad (2.6)$$

Instead of  $x$ , it is slightly more convenient to use the variable

$$y = \frac{x + x_0}{x_0} . \quad (2.7)$$

Curves of constant  $y$  in the  $\Delta T^* - \Delta \rho^*$  plane are indicated schematically in Fig. 2. The coexistence curve corresponds to  $y = 0$ , the critical isotherm to  $y = 1$  and the critical isochore to  $y = \infty$ .

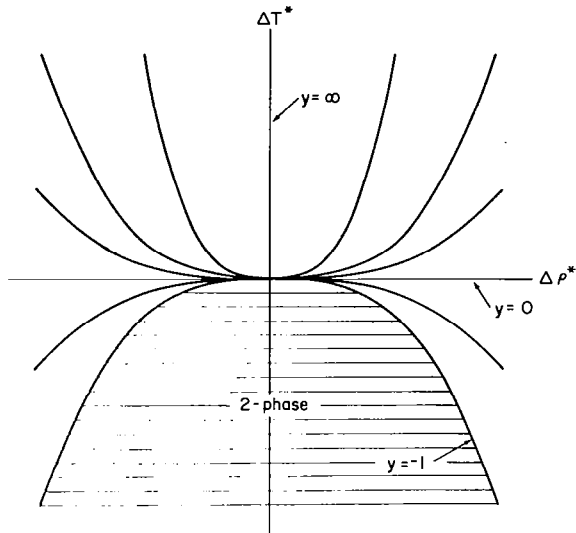

Fig. 2 Curves of constant  $y$  in the  $\Delta T^*$  versus  $\Delta \rho^*$  plane.

Sufficiently close to the critical point, the singular behavior of the thermodynamic properties, when reduced appropriately, becomes a function of the scaling variable  $y$ . To specify the thermodynamic properties in the critical region completely, the scaled contributions are supplemented with contributions that are analytic functions of the physical variables. The expressions thus obtained for a number of thermodynamic properties are listed in Table II (Sengers and Levelt Sengers, 1977).



Table II Scaled expressions for thermodynamic functions<sup>†</sup>

Chemical potential

$$\mu^* = \mu_o^*(T^*) + \Delta\rho^* |\Delta\rho^*|^{\delta-1} Dh(y)$$

Compressibility

$$\chi_T^{*-1} = |\Delta\rho^*|^{\delta-1} D \left[ \delta h(y) + \frac{1}{\beta} (1-y) \frac{dh(y)}{dy} \right]$$

Pressure

$$P^* = P_o^*(T^*) + D \left[ \Delta\rho^* |\Delta\rho^*|^{\delta-1} h(y) + |\Delta\rho^*|^{\delta+1} \{h(y) - a(y)\} \right]$$

Pressure coefficient

$$\left( \frac{\partial P^*}{\partial T^*} \right)_{\rho^*} = \frac{dP_o^*(T^*)}{dT^*} + \frac{D}{x_o} \left[ \Delta\rho^* |\Delta\rho^*|^{(\gamma-1)/\beta} \frac{dh(y)}{dy} + |\Delta\rho^*|^{(1-\alpha)/\beta} \left\{ \frac{dh(y)}{dy} - \frac{da(y)}{dy} \right\} \right]$$

Helmholtz free energy density

$$A^* = -P_o^*(T^*) + \rho^* \mu_o^*(T^*) + |\Delta\rho^*|^{\delta+1} Da(y)$$

Entropy density

$$S^* = \frac{dP_o^*}{dT^*} - \rho^* \frac{d\mu_o^*(T^*)}{dT^*} - |\Delta\rho^*|^{(1-\alpha)/\beta} \frac{D}{x_o} \frac{da(y)}{dy}$$

Heat capacity

$$\frac{C_v^*}{T^*} = \frac{d^2 P_o^*}{dT^{*2}}(T^*) - \rho^* \frac{d^2 \mu_o^*(T^*)}{dT^{*2}} - |\Delta\rho^*|^{-\alpha/\beta} \frac{D}{x_o^2} \frac{d^2 a(y)}{dy^2}$$

---

<sup>†</sup>  $P_o^*(T^*)$  and  $\mu_o^*(T^*)$  are analytic functions of  $T^*$  .

Here the singular behavior of the thermodynamic properties is expressed in terms of two scaling functions  $h(y)$  and  $a(y)$  which are related by the differential equation (Griffiths, 1967; Levelt Sengers et al., 1976):

$$\beta h(y) = \beta(\delta+1)a(y) + (1-y)\frac{da(y)}{dy} \quad . \quad (2.8)$$

The function  $h(y)$  is normalized such that  $h(1) = 1$ .

As an example, we consider the scaling law for the chemical potential

$$\Delta\mu^* = \Delta\rho^* |\Delta\rho^*|^{\delta-1} Dh(y) \quad . \quad (2.9)$$

Normally, the chemical potential is a function of two variables, density and temperature. However, the scaling law (2.9) implies that when "scaled" chemical potential data  $\Delta\mu^*/D\Delta\rho^* |\Delta\rho^*|^{\delta-1}$  are plotted as a function of the "scaled" temperature  $y$ , the data should collapse onto a single curve. As an example, we show in Fig. 3 such a plot for steam. This plot is based on the experimental data of Rivkin and coworkers (1962, 1963, 1966) as analyzed by Levelt Sengers et al. (1976).

## 2.3 Equations of state for the critical region

### 2.3.1 MLSG equation of state

The equation of state is commonly defined as a functional relationship between the pressure  $P$ , the volume  $V$  and the temperature  $T$ . However, in the critical region the density  $\rho$  is a more suitable variable than the volume  $V$  (Vicentini-Missoni et al., 1969a). Since  $\mu$  is the thermodynamic function conjugate to the density  $\rho$ , the equation of state considered here is the functional relationship between the chemical potential  $\mu$ , the density  $\rho$  and the temperature  $T$ . Thus to specify the scaled equation of state, we need to specify the function  $h(y)$  in (2.9). One equation, proposed for this purpose, is the so-called NBS- or MLSG-equation (Vicentini-Missoni et al., 1969a,b; Levelt Sengers et al., 1976; Sengers and Levelt Sengers, 1977)

$$h(y) = y \left( \frac{1 + Ey^{2\beta}}{1 + E} \right)^{(\gamma-1)/2\beta} \quad , \quad (2.10)$$

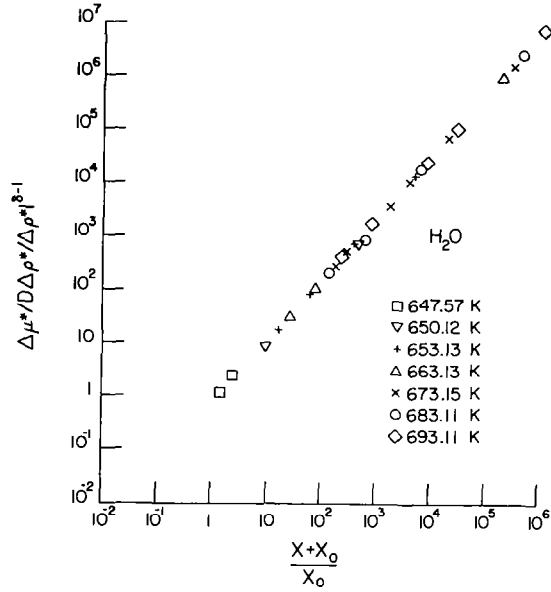

Fig. 3 Scaled chemical potential data for steam as a function of  $y = (x + x_0)/x_0$ . Reduction parameters are taken from Table IV.

where E is a constant. As a consequence, the symmetrized isothermal compressibility  $\chi_T^*$  is represented by

$$\chi_T^* = |\Delta\rho^*|^{-\gamma/\beta} \left[ \frac{[(1+E)/(1+Ey^{2\beta})]^{(\gamma-1)/2\beta}}{D[\delta + (y-1)(\delta - \beta^{-1} + Ey^{2\beta})/(1+Ey^{2\beta})]} \right]. \quad (2.11)$$

Note that at the critical isochore  $\Delta\rho^* = 0$  and eq. (2.11) reduces to

$$\chi_T^* = \Gamma |\Delta T^*|^{-\gamma} \quad (2.12)$$

In terms of the MLSG equation of state, the amplitudes B,  $\Gamma$  and  $\Gamma'$  of the critical power laws, defined in Table I for the coexistence curve and the compressibility, are related to D and  $x_0$  by

$$B = x_o^{-\beta} \quad (2.13a)$$

$$\Gamma = \frac{x_o^\gamma}{D} \left( \frac{1+E}{E} \right)^{(\gamma-1)/2\beta} \quad , \quad (2.13b)$$

$$\Gamma' = \frac{\beta x_o^\gamma}{D} (1+E)^{(\gamma-1)/2\beta} \quad (2.13c)$$

### 2.3.2 Linear model equation of state

The MLSG equation has the advantage that it enables one to calculate the compressibility  $\chi_T^*$  directly for given values of  $\Delta T^*$  and  $\Delta \rho^*$ . However, it has the disadvantage that the expression (2.10) for  $h(y)$  cannot be integrated analytically to yield an explicit expression for  $a(y)$  and, hence, for the pressure. This problem is solved by introducing two auxiliary ("parametric") variables  $r$  and  $\theta$  instead of the variables  $\Delta T^*$  and  $\Delta \rho^*$ .

Here we consider the linear model, originally introduced by Schofield (1969). It is defined by

$$\Delta T^* = r(1-b^2\theta^2) \quad , \quad (2.14a)$$

$$\Delta \rho^* = kr^\beta \theta \quad , \quad (2.14b)$$

$$\Delta \mu^* = ar^{\beta\delta} \theta(1-\theta^2) \quad , \quad (2.14c)$$

where  $a$ ,  $k$  and  $b^2$  are constants. This model is chosen such that  $\theta = \pm 1$  correspond to the two branches of the coexistence curve,  $\theta = \pm 1/b$  to the critical isotherm and  $\theta = 0$  to the critical isochore. The resulting parametric expressions for a number of thermodynamic properties are given in Table III. The amplitudes of the critical power laws defined in Table I are related to the linear model constants by (Hohenberg and Barmatz, 1972; Sengers and Levelt Sengers, 1977)

$$B = k/(b^2-1)^\beta \quad , \quad (2.15a)$$

$$D = a(b^2-1)b^{\delta-3}/k^\delta \quad , \quad (2.15b)$$

$$\Gamma = k/a \quad , \quad (2.15c)$$

$$\Gamma' = (b^2-1)^{\gamma-1} \{1-b^2(1-2\beta)\} k/2a \quad , \quad (2.15d)$$

$$A^+ = ak(2-\alpha)(1-\alpha)\alpha p_0 \quad (2.15e)$$

$$A^- = ak(2-\alpha)(1-\alpha)\alpha(p_0 + p_2 + p_4)/b^{2-\alpha} \quad (2.15f)$$

Table III Linear model equations for thermodynamic properties

Variables

$$\Delta T^* = r(1-b^2\theta^2)$$

$$\Delta \rho^* = r^\beta k\theta$$

Chemical potential

$$\mu^* = \mu_0^*(T^*) + r^{\beta\delta} a\theta(1-\theta^2)$$

Compressibility

$$\chi_T^* = r^{-\gamma} \frac{k}{a} \cdot \frac{1-(1-2\beta)b^2\theta^2}{1-3\theta^2 + b^2\theta^2 \{3\theta^2 - 1 + 2\beta\delta(1-\theta^2)\}}$$

Pressure

$$P^* = P_0^*(T^*) + r^{\beta\delta} a\theta(1-\theta^2) + r^{\beta(\delta+1)} akp(\theta)$$

Pressure coefficient

$$\left(\frac{\partial P^*}{\partial T^*}\right)_{\rho^*} = \frac{dP_0^*(T^*)}{dT^*} + r^{1-\alpha} aks(\theta) + \rho^* r^{\beta\delta-1} a\beta\theta \frac{\delta(1-\theta^2) - (1-3\theta^2)}{1-(1-2\beta)b^2\theta^2}$$

Helmholtz free energy density

$$A^* = -P_0^*(T^*) + \rho^* \mu_0^*(T^*) + r^{2-\alpha} ak\{\theta^2(1-\theta^2) - p(\theta)\}$$

Entropy density

$$S^* = \frac{dP_0^*(T^*)}{dT^*} - \rho^* \frac{d\mu_0^*(T^*)}{dT^*} + r^{1-\alpha} aks(\theta)$$

Table III (continued)

Heat capacities

$$\frac{C_V^*}{T^*} = \frac{d^2 p_o^*(T^*)}{dT^{*2}} - \rho^* \frac{d^2 \mu_o^*(T^*)}{dT^{*2}} + r^{-\alpha} a_k \frac{(1-\alpha)s(\theta) - \beta\theta s'(\theta)}{1 - (1-2\beta)b^2\theta^2}$$

$$\frac{C_P^*}{T^*} = \frac{C_V^*}{T^*} + \frac{\chi_T^*}{\rho^{*2}} \left( \frac{\partial p^*}{\partial T^*} \right)^2_{\rho^*}$$

Auxiliary functions

$$p(\theta) = p_o + p_2\theta^2 + p_4\theta^4, \quad s(\theta) = s_o + s_2\theta^2, \quad s'(\theta) = 2s_2\theta$$

with

$$p_o = + \frac{\beta(\delta-3) - b^2\alpha\gamma}{2b^4(2-\alpha)(1-\alpha)\alpha}$$

with

$$s_o = (2-\alpha)p_o, \quad s_2 = - \frac{\beta(\delta-3)}{2b^2\alpha}$$

$$p_2 = - \frac{\beta(\delta-3) - b^2\alpha(2\beta\delta-1)}{2b^2(1-\alpha)\alpha}$$

$$p_4 = + \frac{2\beta\delta-3}{2\alpha}$$

A computer program calculating the parametric variables  $r$  and  $\theta$  for given temperatures and densities is presented in the Appendix. A similar program has been published by Moldover (1978).

The linear model constant  $b^2$  is sometimes identified with (Schofield et al., 1969)

$$b^2 = \frac{\delta-3}{(\delta-1)(1-2\beta)} \quad . \quad (2.16)$$

The linear model with condition (2.16) is referred to as the restricted linear model. Further details can be found in the previous technical report (Sengers and Levelt Sengers, 1977).

#### 2.4 Universality

The principle of universality asserts that the critical exponents and the scaling function  $h(y)$  should be the same for all 3-dimensional systems with short range forces. The only system dependent constants in the scaling laws are the coefficients  $D$  and  $x_0$  which specify the amplitude of the critical isotherm and the coexistence curve, respectively (Levelt Sengers, 1977a). In terms of the MSLG equation of state and the linear model equation of state, this principle requires the constants  $E$  and  $b^2$  to be universal.

Since we are applying the scaling laws outside their asymptotic range using effective critical exponent values and effective values for  $E$  and  $b^2$ , the principle of universality will only apply approximately. In order to illustrate to what extent this empirical extension of the universality principle is adequate, we reproduce in Fig. 4 scaled chemical potential data for  $^3\text{He}$ ,  $^4\text{He}$ ,  $\text{Xe}$ ,  $\text{CO}_2$  and  $\text{H}_2\text{O}$  (Levelt Sengers, 1974; Levelt Sengers et al., 1976; Sengers and Levelt Sengers, 1977). The data can be represented approximately by a single function of the scaling variable  $y = (x + x_0)/x_0$ . The data cover a range in temperatures and densities bounded by

$$5 \times 10^{-4} \leq |\Delta T^*| \leq 3 \times 10^{-2} \quad , \quad |\Delta \rho^*| \leq 0.25 \quad . \quad (2.17)$$

The principle of corresponding states would imply identical behavior when the thermodynamic properties are reduced using the critical parameters  $T_c$ ,  $\rho_c$ ,  $P_c$ . The fluids included in Fig. 4 do not satisfy corresponding states. However, the universality hypothesis is a generalization of corresponding states, saying that identical behavior of the singular critical behavior of the thermodynamic properties is obtained by use of two additional constants,  $D$  and  $x_0$ , or in terms of the linear model,  $a$  and  $k$ . In Table IV, taken from the previous technical report (Sengers and Levelt Sengers, 1977), we have listed these parameters for a number of fluids. In this table we have added parametric values for isobutane, taken from an NBS Internal Report (Waxman et al., 1978).

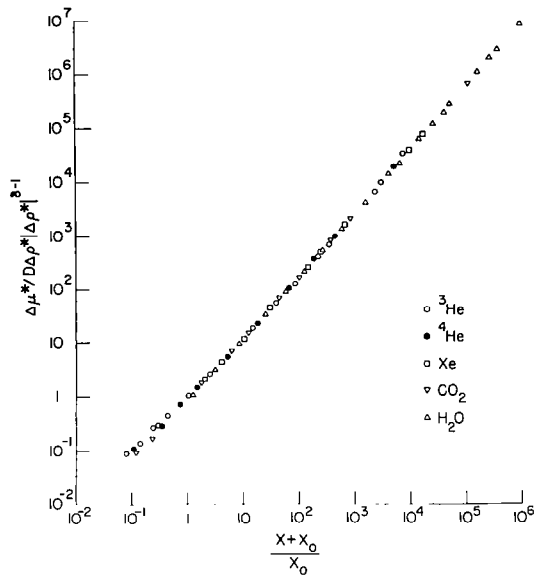

Fig. 4 Scaled chemical potential data for  $^3\text{He}$ ,  $^4\text{He}$ , Xe,  $\text{CO}_2$  and  $\text{H}_2\text{O}$  as a function of  $y = (x+x_0)/x_0$ . Reduction parameters are taken from Table IV (Sengers and Levelt Sengers, 1977).



Table IV. Critical region parameters for a number of fluids with effective universal exponent values (Sengers and Levelt Sengers, 1977).

	$P_c$ MPa	$\rho_c$ kg/m <sup>3</sup>	$T_c$ K	$x_o$	D	k	a	$\xi_o \times 10^{10}$ m
<sup>3</sup> He	0.11678	41.45	3.3099	0.489	3.16	0.924	4.58	2.7
<sup>4</sup> He	0.22742	69.6	5.1895	0.369	2.86	1.021	6.40	2.2
Ar	4.865	535.	150.725	0.183	2.43	1.309	16.1	1.6
Kr	5.4931	908.	209.286	0.183	2.43	1.309	16.1	1.7
Xe	5.8400	1110.	289.734	0.183	2.43	1.309	16.1	1.9
p-H <sub>2</sub>	1.285	31.39	32.935	0.260	2.50	1.156	9.6	1.9
N <sub>2</sub>	3.398	313.9	126.20	0.164	2.32	1.361	18.2	1.6
O <sub>2</sub>	5.043	436.2	154.580	0.183	2.36	1.309	15.6	1.6
H <sub>2</sub> O	22.06	322.2	647.13	0.100	1.28	1.622	21.6	1.3
D <sub>2</sub> O	21.66	357.	643.89	0.100	1.28	1.622	21.6	1.3
CO <sub>2</sub>	7.3753	467.8	304.127	0.141	2.16	1.436	21.3	1.6
NH <sub>3</sub>	11.303	235.	405.4	0.109	1.47	1.573	21.4	1.4
SF <sub>6</sub>	3.7605	730.	318.687	0.172	3.06	1.337	23.9	2.0
CH <sub>4</sub>	4.595	162.7	190.555	0.164	2.17	1.361	17.0	1.7
C <sub>2</sub> H <sub>4</sub>	5.0390	215.	282.344	0.168	2.32	1.350	17.5	1.9
C <sub>2</sub> H <sub>6</sub>	4.8718	206.5	305.33	0.147	2.17	1.416	20.2	1.8
C <sub>3</sub> H <sub>8</sub>	4.247	221.	369.82	0.137	1.96	1.451	20.2	2.0
iso-C <sub>4</sub> H <sub>10</sub>	3.631	227.	407.85	0.140	2.07	1.441	20.8	2.2

Notes:  $\alpha = 0.100$ ,  $\beta = 0.355$ ,  $\gamma = 1.190$ ,  $\delta = 4.352$ ,  $\nu = 0.633$ ,  $E = 0.287$ ,  $b^2 = 1.3909$

## 2.5 A fundamental equation for the critical region

The scaled equations introduced in the previous section enable us to calculate the singular critical behavior of the thermodynamic properties. However, in order to obtain the complete thermodynamic behavior, we need to specify the analytic background functions  $P_0^*(T^*)$  and  $\mu_0^*(T^*)$  (see Tables II and III). This is accomplished by expanding  $P_0^*(T^*)$  and  $\mu_0^*(T^*)$  in a Taylor series in terms of  $\Delta T^*$  (Levelt Sengers, 1977b).

$$P_0^*(T^*) = 1 + \sum_{i=1} P_i^*(\Delta T^*)^i, \quad (2.18)$$

$$\mu_0^*(T^*) = \mu_c^* + \sum_{i=1} \mu_i^*(\Delta T^*)^i. \quad (2.19)$$

Based on linear model parameters earlier determined by Murphy et al., (1973, 1975), these background parameters have been determined for steam and carbon dioxide. For steam this task was done by Levelt Sengers (1977b) and the fundamental equation parameters are reproduced in Table V. For carbon dioxide this task was accomplished by Cook and Sengers as part of this project. The parameters for  $\text{CO}_2$ , deduced from the experimental data of Michels et al. (1937, 1948, 1952), including a correction for the temperature scale (Levelt Sengers and Chen, 1972; Levelt Sengers et al., 1976), are also given in Table V.†

## 2.6 Correlation length

We shall try to relate the critical enhancement of the transport properties to the thermodynamic properties and the correlation length  $\xi$  which measures the size of the critical fluctuations. For this purpose we calculate the correlation length using an approximate relationship with the compressibility introduced in the previous technical report (Sengers and Levelt Sengers, 1977)

$$\xi = \xi_0 (\chi_T^*/\Gamma)^{\nu/\gamma}, \quad (2.20)$$

where the correlation function exponent  $\nu$  is related to the thermodynamic critical exponents by the hyperscaling relation

---

† In this report all temperatures are quoted in terms of the International Practical Scale of 1968, referred to as IPTS '68 (Douglas, 1969).

Table V Fundamental equation parameters based on  
the linear model with effective exponent values

	steam <sup>†</sup>	carbon dioxide <sup>††</sup>
Critical parameters	$\rho_c = 324.383 \text{ kg/m}^3$	$\rho_c = 467.8 \text{ kg/m}^3$
	$P_c = 22.0477 \text{ MPa}$	$P_c = 7.37516 \text{ MPa}$
	$T_c = 647.073 \text{ K (IPTS '68)}$	$T_c = 304.127 \text{ K (IPTS '68)}$
Critical exponents	$\alpha = 0.08712$	$\alpha = 0.128$
	$\beta = 0.3505$	$\beta = 0.3486$
	$\gamma = 1.2119$	$\gamma = 1.175$
	$\delta = 4.4576$	$\delta = 4.37$
	$\nu = 0.6367$	$\nu = 0.624$
Linear model parameters	$a = 24.0999$	$a = 24.4878$
	$k = 1.6837$	$k = 1.745$
	$b^2 = 1.4099$	$b^2 = 1.70$
Coefficients $P_i^*$	$P_1^* = 7.87425$	$P_1^* = 6.9992$
	$P_2^* = -25.8448$	$P_2^* = -8.8535$
	$P_3^* = 3.96522$	—
Coefficients $\mu_i^*$	$\mu_1^* = -34.05$	$\mu_2^* = 13.0231$
	$\mu_2^* = -16.59$	$\mu_3^* = -49.2265$
	$\mu_3^* = 59.84$	$\mu_4^* = 423.428$
Correlation length amplitude	$\xi_o = 1.31 \times 10^{-10} \text{ m}$	$\xi_o = 1.5 \times 10^{-10} \text{ m}$
Range	$ \Delta T^*  \leq 0.05,  \Delta \rho^*  \leq 0.25$	$ \Delta T^*  \leq 0.03,  \Delta \rho^*  \leq 0.28$

<sup>†</sup>From Levelt Sengers (1977b).

<sup>††</sup>From Cook and Sengers (unpublished report, 1974).

$$\nu = \beta(\delta+1)/3 \quad . \quad (2.21)$$

The amplitude  $\xi_0$  for the correlation length can be related to the critical power law amplitudes  $B$  and  $\Gamma$ , defined in Table I, by

$$\xi_0 = R(\Gamma k_B T_c / B^2 P_c)^{1/3} \quad (2.22)$$

where  $R$  is a universal constant whose value is approximately equal to 0.7 (Sengers and Levelt Sengers, 1977; Sengers and Moldover, 1978). Values for the correlation length amplitude  $\xi_0$  are included in Tables IV and V.

The above equations allow us to calculate the correlation length  $\xi$  from the symmetrized reduced compressibility  $\chi_T^*$  by the use of either the MLSG equation (2.11) or the linear model equation for  $\chi_T^*$  given in Table III.

### 3. Transport properties

#### 3.1 Introductory remarks

The thermal conductivity  $\lambda$  and the shear or dynamic viscosity  $\eta$  exhibit a critical enhancement in the vicinity of the critical point. For a survey of the history of the subject the reader is referred to some earlier reviews (Sengers, 1966, 1971, 1972, 1973).

In Fig. 5 we show schematically the thermal conductivity  $\lambda$  as a function of the density  $\rho$  at three temperatures  $T_1 < T_2 < T_3$  above the critical temperature  $T_c$ . In order to describe the critical enhancement, we separate  $\lambda$  into a normal or background thermal conductivity  $\bar{\lambda}$  and a critical thermal conductivity enhancement  $\Delta\lambda$  (Sengers and Keyes, 1971).

Outside the critical region, the thermal conductivity  $\lambda$  is to be identified with the normal thermal conductivity  $\bar{\lambda}$ . Inside the critical region,  $\lambda$  is defined empirically by extrapolating the behavior of the normal thermal conductivity outside the critical region. The normal thermal conductivity  $\bar{\lambda}$  may in turn be written as

$$\bar{\lambda}(\rho, T) = \lambda_0(T) + \lambda_e(\rho, T) \quad , \quad (3.2)$$

where  $\lambda_0(T)$  is the thermal conductivity in the limit of low densities at the same temperature and where  $\lambda_e(\rho, T)$  is commonly referred to in the engineering literature as the excess thermal conductivity. The excess thermal conductivity is a slowly varying function of temperature and increases monotonically with density (Diller et al., 1970; Hanley et al., 1972; Sengers, 1968).

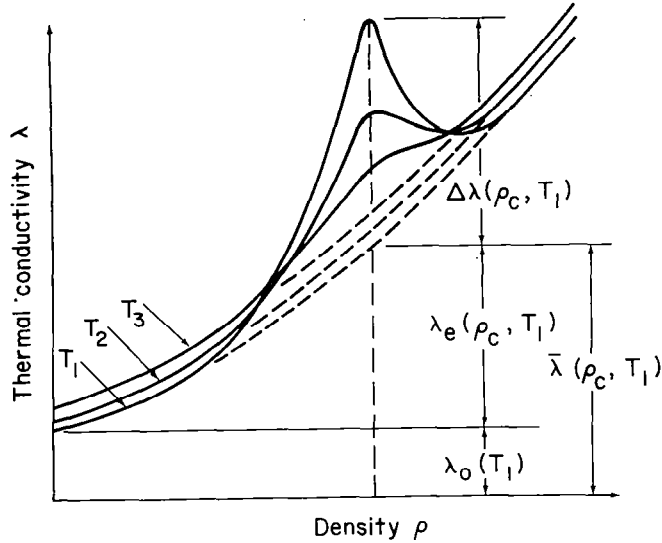

Fig. 5 Schematic representation of the thermal conductivity  $\lambda(\rho, T)$  as a function of the density  $\rho$  at three supercritical temperatures  $T_1 < T_2 < T_3$ .

The behavior of the viscosity  $\eta$  as a function of density at a temperature slightly above the critical temperature is shown schematically in Fig. 6. In analogy to (3.1) and (3.2) we separate the viscosity  $\eta$  into a normal viscosity  $\bar{\eta}$  and a critical viscosity enhancement  $\Delta\eta$

$$\eta = \bar{\eta} + \Delta\eta \quad , \quad (3.3)$$

with

$$\bar{\eta}(\rho, T) = \eta_0(T) + \eta_e(\rho, T) \quad . \quad (3.4)$$

However, there are some qualitative differences between the critical enhancements of the thermal conductivity and of the viscosity. First, the thermal conductivity enhancement is a "strong" enhancement extending over a large range of temperatures and densities, while that of the viscosity is a "weak" enhancement limited to a small range of temperatures, typically a few degrees, around the critical temperature (Sengers, 1973). Secondly, theoretical and experimental evidence indicates that the critical viscosity enhancement is a multiplicative

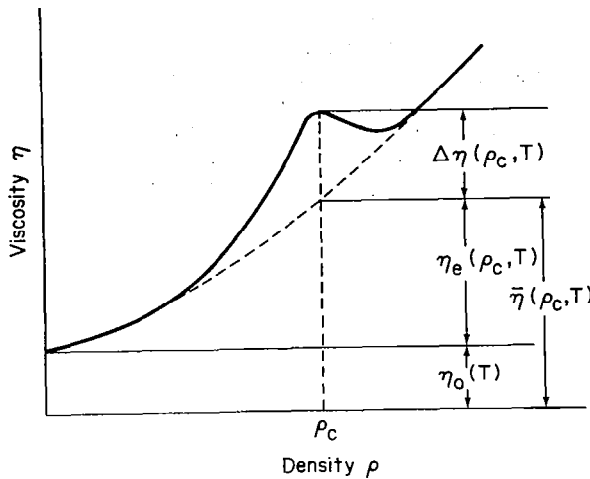

Fig. 6 Schematic representation of the viscosity  $\eta(\rho, T)$  as a function of the density  $\rho$  at a temperature slightly above the critical temperature.

enhancement, i.e.  $\Delta\eta$  is itself proportional to the normal viscosity (Kawasaki, 1971, 1976; Perl and Ferrell, 1972; Sengers 1971, 1973; Ohta, 1977; Calmettes 1977). Thus, in the case of the viscosity, we prefer to consider the relative critical enhancement  $\Delta\eta/\bar{\eta}$  or the viscosity ratio  $\eta/\bar{\eta}$ .

Another transport property of interest is the thermal diffusivity  $D_T = \lambda/\rho c_p$ , where  $c_p$  is the specific heat at constant pressure per unit mass. It can be determined experimentally from measurements of the decay rate of the critical fluctuations with the use of light scattering techniques (Mountain, 1966; Benedek, 1968; McIntyre and Sengers, 1968; Cummins and Swinney, 1970; Fleury and Boon, 1973). This method has the advantage that the thermal diffusivity is measured while the fluid remains in thermodynamic equilibrium but it is in practice limited to a small range around the critical point, where the scattered light intensity is sufficiently large for the method to be applicable. It is also possible to determine the thermal diffusivity from the temperature field in the fluid near a heated boundary, made visible by holographic interferometry (Becker and Grigull, 1975, 1978; Schmitt and Beer, 1977). Although the thermal conductivity diverges at the critical point, the specific heat at constant pressure  $c_p$  increases much faster, so that the thermal diffusivity goes to zero at the critical point.

As mentioned in the previous technical report (Sengers and Levelt Sengers, 1977), the modern theory of critical phenomena is based on a renormalization-group approach. For a more comprehensive introduction to the subject the reader is referred to the literature (Barber, 1977; Domb and Green, 1976; Pfeuty and Toulouse, 1977; Wallace and Zia, 1978; Wilson and Kogut, 1974). Subsequently, the method has been extended to dynamic critical phenomena as well (Siggia et al., 1976; Kawasaki and Gunton, 1976; Gunton and Kawasaki, 1976; Hohenberg and Halperin, 1977; Ernst, 1978; De Dominicis and Peliti, 1978; Mazenko, 1978). Another approach to the theory of dynamic critical phenomena is commonly referred to as mode-coupling theory. In this approach the time correlation function expressions for the transport coefficients are evaluated by use of the methods of generalized hydrodynamics and the critical anomalies arise from non-linear coupling between hydrodynamic modes (Kadanoff and Swift, 1968; Kawasaki, 1970, 1971, 1976; Pomeau and Résibois, 1975). For a discussion of the relationship between the mode-coupling theory and the dynamic renormalization-group theory the reader is referred to a recent survey presented by Gunton (1979). These theories yield expressions for the transport coefficients near the critical point as a function of the wavelength of the fluctuations. In this technical report we only consider the hydrodynamic transport coefficients corresponding to the long wavelength limit.

The dynamic renormalization-group theory predicts that the thermal conductivity and the viscosity near the critical point should diverge as (Siggia et al., 1976; Hohenberg and Halperin, 1977)

$$\Delta\lambda = \Lambda \frac{k_B T}{6\pi\eta\xi} \rho c_p \quad , \quad (3.5)$$

$$\Delta\eta \approx \eta \propto \xi^\phi \quad , \quad (3.6)$$

where  $k_B$  is Boltzmann's constant and where  $\Lambda$  is a universal constant and  $\phi$  a universal exponent independent of the nature of the fluid.

The mode-coupling theory leads to sets of coupled integral equations which are difficult to evaluate. In first approximation one finds (Kawasaki, 1970, 1971, 1976; Ferrell, 1970; Perl and Ferrell, 1972)

$$\Delta\lambda = \frac{k_B T}{6\pi\eta\xi} \rho c_p \approx \frac{k_B T}{6\pi\eta\xi} \rho (c_p - c_v) \quad , \quad (3.7)$$

$$\frac{\Delta\eta}{\eta} = \frac{8}{15\pi^2} \ln(q\xi) \quad , \quad (3.8)$$

where  $q$  is a slowly varying function of temperature (Oxtoby and Gelbart, 1974), but which will be treated here as an adjustable constant. Equation (3.7) may be interpreted physically by assuming that the critical part  $\Delta\lambda/\rho c_p$  of the thermal diffusivity  $D_T$  is determined by the Stokes-Einstein diffusion of clusters with radius  $\xi$ .

Since  $\Delta\eta/\bar{\eta} \ll 1$ , equation (3.8) may be written in the form of a power law (3.6)

$$\frac{\eta}{\bar{\eta}} = 1 + \lambda n(q\xi)^\phi \approx (q\xi)^\phi, \quad (3.9)$$

with  $\phi \approx 8/15\pi^2 \approx 0.054$  (Ohta, 1975; Ohta and Kawasaki, 1976). The exponent  $\phi$  has also been calculated from a perturbation expansion up to second order in  $\epsilon = 4 - d$ , where  $d$  is the dimensionality of the system, yielding  $\phi \approx 0.065$  (Siggia et al., 1976; Gunton, 1979). Expanding  $\Lambda$  up to first order in  $\epsilon$ , Siggia et al. estimated  $\Lambda \approx 1.2$ . On comparing (3.7) with (3.5) we note that the mode-coupling theory implies in first approximation the value  $\Lambda = 1.0$ . Recent experimental studies very close to the critical point have indicated that the value of  $\Lambda$  is indeed close to unity (Burstyn et al., 1980; Güttinger and Cannell, 1980).

As mentioned in Section 2, the asymptotic scaling laws for the equilibrium properties become valid rigorously at temperatures within a few hundredths of a percent from the critical temperature. Due to the additional approximations in the derivation of the asymptotic power laws for the transport properties, the range of validity of equations introduced above will be even smaller. Just as in the case of the thermodynamic properties, we adopt here a practical approach in which the thermal conductivity and the viscosity in the critical region are presented by (3.5) and (3.9), but allowing for effective values of the amplitude  $\Lambda$  and the exponent  $\phi$  which may differ slightly from the values predicted theoretically.

## 3.2 Thermal conductivity

### 3.2.1 Thermal conductivity equation

The asymptotic equation (3.5) for the critical thermal conductivity enhancement will only be applicable in a relatively small region of temperatures and densities around the critical point. However, the actual observed critical thermal conductivity enhancement covers a large range of temperatures and densities. For instance, in the case of carbon dioxide a critical enhancement is noted in a temperature range of 70°C above the critical temperature (Le Neindre et al., 1973). In practice, one needs a representative equation covering the entire range of the critical enhancement. For this purpose we adopt an equation of the form (Hanley et al., 1974b, 1976).

$$\lambda = \bar{\lambda} + \Delta\lambda, \quad (3.10)$$

with



$$\Delta\lambda = \Lambda \frac{k_B T}{6\rho\eta\xi} \rho(c_p - c_v) F(\Delta T^*, \Delta\rho^*) \quad . \quad (3.11)$$

Here  $F(\Delta T^*, \Delta\rho^*)$  is an empirical crossover function such that

$$\lim_{|\Delta T^*| \rightarrow 0, |\Delta\rho^*| \rightarrow 0} F(\Delta T^*, \Delta\rho^*) = 1, \quad \lim_{|\Delta T^*| \rightarrow \infty, |\Delta\rho^*| \rightarrow \infty} F(\Delta T^*, \Delta\rho^*) = 0 \quad . \quad (3.12)$$

In practice, we continue to use a crossover function earlier introduced by Hanley et al. (1974b, 1976):

$$F(\Delta T^*, \Delta\rho^*) = \rho^{*\Omega} \exp[-\{A_\lambda (\Delta T^*)^2 + B_\lambda (\Delta\rho^*)^4\}] \quad . \quad (3.13)$$

The crossover function insures that equation (3.11) for  $\Delta\lambda$  reduces to the theoretically predicted equation (3.5) upon approaching the critical point, while  $\lambda$  reduces to the normal thermal conductivity  $\bar{\lambda}$  far away from the critical point.

Equation (3.11) relates the critical thermal conductivity enhancement  $\Delta\lambda$  to the thermodynamic properties, the viscosity  $\eta$  and the correlation length  $\xi$ . Using the thermodynamic relationship between the specific heat at constant pressure and constant volume

$$\rho(c_p - c_v) = \frac{P}{T} \frac{c}{\rho^{*2}} \chi_T^* \left( \frac{\partial P^*}{\partial T^*} \right)_{\rho^*}^2, \quad (3.14)$$

and the relationship (2.20) between the correlation length and the symmetrized compressibility  $\chi_T^*$ , we may rewrite (3.11) as

$$\Delta\lambda = \frac{\Lambda}{\Xi_0} \frac{k_B P}{6\pi\eta} \left( \frac{T^*}{\rho^*} \right)^2 \left( \frac{\partial P^*}{\partial T^*} \right)_{\rho^*}^2 \chi_T^{*(\gamma-\nu)/\gamma} F(\Delta T^*, \Delta\rho^*) \quad , \quad (3.15)$$

with

$$\Xi_0 = \xi_0 / \Gamma^{\nu/\gamma} \quad . \quad (3.16)$$

Since the critical viscosity enhancement is much weaker than the critical thermal conductivity enhancement, we may approximate the viscosity  $\eta$  in (3.11) and (3.15) by the normal viscosity  $\bar{\eta}$ . This approximation is adequate within the accuracy with which the thermal conductivity near the critical point is known experimentally.

The function  $F$  in (3.11) and (3.15) is an empirical crossover function and the parameters  $A_\lambda$  and  $B_\lambda$ , as well as the exponent  $n$ , in (3.13) are to be determined from the experimental thermal conductivity data. As a first approximation, these parameters were treated by Hanley et al. (1974b, 1976) as constants independent of the nature of the fluid. This assumption is strictly only valid for noble gases, where the thermal conductivity can be expected to satisfy corresponding states. In practice, these parameters, as well as the optimal form of the crossover function, may vary somewhat from fluid to fluid.

The calculation of the thermal conductivity enhancement from (3.15) requires knowledge of the symmetrized isothermal compressibility  $\chi_T^*$  and of the pressure coefficient  $(\partial P^*/\partial T^*)_\rho$ . Since the compressibility is strongly divergent, it is imperative that  $\chi_T^*$  be calculated from an appropriate scaled equation. For a large number of fluids the compressibility  $\chi_T^*$  can be calculated from the parameters quoted in Table IV. However, in order to calculate  $(\partial P^*/\partial T^*)_\rho$  an equation for  $\mu^*(\rho^*, T^*)$  is insufficient and a more complete equation of state is required. A more complete equation of state based on the scaling laws is currently available for few substances only, namely for steam (Levelt Sengers, 1977b) and for carbon dioxide (Basu and Sengers, 1980) as discussed in Section 2.5, and also for isobutane (Waxman et al., 1978). However, since  $(\partial P^*/\partial T^*)_\rho$  remains finite at the critical point, already a substantial improvement is obtained when  $\chi_T^*$  is calculated from the parameters presented in this report, even while  $(\partial P^*/\partial T^*)_\rho$  is calculated from a conventional equation of state (Hanley et al., 1976).

### 3.2.2 Thermal conductivity of carbon dioxide

In order to test the applicability of the proposed thermal conductivity equation, we consider a few representative examples where adequate experimental information is available. In particular for carbon dioxide, the thermal conductivity has been determined over a wide range of temperatures and densities around the critical point. The thermal conductivity in the critical region up to 75°C was measured by one of the authors in collaboration with Michels and van der Gulik using a parallel plate method (Michels et al., 1962). The temperature range was subsequently extended by Le Neindre et al. (1973) up to 700°C using a concentric cylinder method. The thermal diffusivity in the critical region of CO<sub>2</sub> was measured accurately by Becker and Grigull (1978) from a holographic interferometric analysis of the transient temperature field in the gas under a heated horizontal plate.

The data of Le Neindre et al. (1973) enable us to present the normal thermal conductivity  $\bar{\lambda}$  as

$$\bar{\lambda} = \lambda_o(\bar{T}) + \sum_{i=1}^3 \lambda_i \bar{\rho}^i, \quad (3.17)$$

with

$$\lambda_o(\bar{T}) = \bar{T}^{-1/2} \sum_{k=0}^3 a_k^\lambda / \bar{T}^k \quad . \quad (3.18)$$

Here  $\bar{T}$  and  $\bar{\rho}$  are dimensionless variables defined as

$$\bar{T} = T/T_r \quad , \quad \bar{\rho} = \rho/\rho_r \quad , \quad (3.19)$$

with respect to a reference temperature  $T_r$  and a reference density  $\rho_r$ . In the case of  $CO_2$  we adopt, for convenience only, the reference values

$$T_r = 100 \text{ K} \quad , \quad \rho_r = 100 \text{ kg/m}^3 \quad . \quad (3.20)$$

The coefficients  $a_k^\lambda$  in (3.18) were determined by Watson (1976b) and are reproduced in Table VIA. The coefficients  $\lambda_i$  in (3.17) were presented in an earlier technical report (Sengers, 1972) and are reproduced in Table VIB.

Table VI. Coefficients in the equation for the normal thermal conductivity  $\bar{\lambda}$  of  $CO_2$

VIA The coefficients  $a_k^\lambda$

$a_0^\lambda = + 32.3537 \text{ m.K/W}$
$a_1^\lambda = + 77.1034 \text{ m.K/W}$
$a_2^\lambda = + 618.115 \text{ m.K/W}$
$a_3^\lambda = - 613.848 \text{ m.K/W}$

VIB The coefficients  $\lambda_i$

$\lambda_1 = 0.33789 \times 10^{-2} \text{ W m}^{-1} \text{ K}^{-1}$
$\lambda_2 = 0.27725 \times 10^{-3} \text{ W m}^{-1} \text{ K}^{-1}$
$\lambda_3 = 0.47396 \times 10^{-4} \text{ W m}^{-1} \text{ K}^{-1}$

Using the parameter values

$$n = 0 \quad , \quad \Lambda = 1.02 \quad , \quad A_\lambda = 39.8 \quad , \quad B_\lambda = 5.45 \quad , \quad (3.21)$$

we present in Fig. 7 a comparison of the proposed thermal conductivity equation with the thermal conductivity data of Michels et al. (1962) and those reported by Becker and Grigull (1978). For this purpose we adopted the values  $n=0$  and  $\Lambda=1.02$ , while  $A_\lambda$  and  $B_\lambda$  were treated as adjustable parameters (Basu and Sengers, 1980). The thermodynamic properties in a region bounded by  $|\Delta T^*| \leq 0.03$  and  $|\Delta \rho^*| \leq 0.28$ , and also the constant  $\Xi_0$ , were calculated using the parameter values given in Table V. Outside this region, we used tabulated thermodynamic property data values based on the experimental data of Michels and coworkers (Michels and Michels, 1935, 1937; Michels et al., 1937; Michels and de Groot, 1948; Michels and Strijland, 1952). The viscosity was calculated from an equation formulated by Watson (1976a).

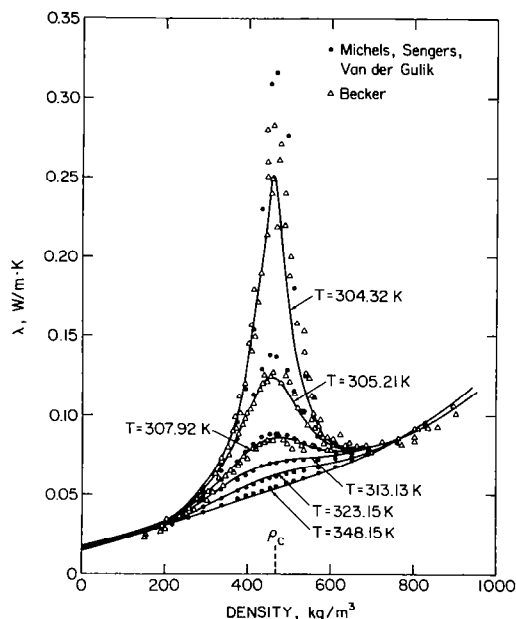

Fig. 7 Thermal conductivity data for carbon dioxide in the critical region along isotherms as a function of density. The curves indicate the values calculated from the representative equation proposed in this report.

It is noted that the property determined experimentally by Becker and Grigull (1978) is the thermal diffusivity and not the thermal conductivity. Hence, a comparison between the two data sets is affected by the accuracy with which the specific heat  $c_p$  close to the critical point can be calculated. The thermal conductivity data, reported by Becker and Grigull and reproduced in Fig. 7, were deduced from the experimental thermal diffusivity data, when the specific heat was calculated from the fundamental equation presented in Section 2.5 with  $T_c = 304.127$  K as determined by Moldover (1974). However, the actual value of  $T_c$  observed by Becker and Grigull in their experiment was 304.144 K. If the latter value of  $T_c$  is used, the thermal conductivities deduced from the thermal diffusivity data become slightly larger close to the critical point, leading to an almost perfect agreement with the data of Michels et al. (1962) at temperatures down to 305.21 K, but yielding a somewhat larger peak at 304.32 K. In view of the fact that the peak heights at 304.32 K and 305.21 K are sensitive to the value adopted for  $T_c$ , we conclude from Fig. 7 that our equation yields a reasonable representation of the thermal conductivity in the critical region.

### 3.2.3 Thermal conductivity of steam

The existence of a critical enhancement in the thermal conductivity of steam was demonstrated experimentally by Le Neindre et al. (1973) with a concentric cylinder apparatus and by Sirota, Latunin and Belyaeva (1973) with a parallel plate apparatus. Subsequently, Sirota et al. (1974, 1976) have published a large amount of data for the thermal conductivity of steam in the critical region.

In order to represent the experimental thermal conductivity data in the critical region by the equations proposed in Section 3.2.1, we need again an equation for the normal thermal conductivity  $\bar{\lambda} = \lambda_o(T) + \lambda_e(\rho, T)$ . In the case of carbon dioxide discussed in the previous section, this task was considerably simplified by the observation that the excess thermal conductivity  $\lambda_e(\rho, T)$  is independent of the temperature  $T$  in a large range of temperatures outside the critical region (Le Neindre et al., 1973). However, the assumption that the excess thermal conductivity  $\lambda_e(\rho, T)$  is independent of the temperature over a large range of temperatures, is not justified in the case of steam. For this reason we do not want to use equation (3.17) with values for the coefficients  $\lambda_i$  deduced from thermal conductivity data far away from the critical temperature. In our first approach, we retained equation (3.17) but determined the coefficients  $\lambda_i$  simultaneously with the parameters in the equation (3.15) for  $\Delta\lambda$  from the experimental data in the critical region. This procedure yields a satisfactory representation of the experimental thermal conductivity data of steam in the critical region (Basu and Sengers, 1977). However, the equation thus obtained cannot be readily extrapolated to represent the thermal conductivity of water and steam over a large range of temperatures and densities.

In order to accomplish the latter purpose, we adopted for  $\bar{\lambda}$  an equation of the form

$$\bar{\lambda} = \lambda_o(\bar{T}) \exp \left[ \bar{\rho} \sum_{i=0}^4 \sum_{j=0}^5 b_{ij}^{\lambda} \left( \frac{1}{\bar{T}} - 1 \right)^i (\bar{\rho} - 1)^j \right] \quad , \quad (3.22)$$

with

$$\lambda_o(\bar{T}) = \bar{T}^{-1/2} / \sum_{k=0}^3 \frac{a_k}{\bar{T}^k} \quad (3.23)$$

Here  $\bar{T}$  and  $\bar{\rho}$  are again dimensionless variables defined as (cf. (3.19)) •

$$T = T/T_r, \quad \bar{\rho} = \rho/\rho_r \quad (3.24)$$

For steam we took the reference values

$$T_r = 647.27 \text{ K}, \quad \rho_r = 317.763 \text{ kg/m}^3 \quad (3.25)$$

The choice of this equation for  $\bar{\lambda}$  was motivated by the observation that an equation of the same form yields an accurate representation of the viscosity of water and steam in a large range of temperatures and densities outside the critical region (Hendricks et al., 1977; Nagashima, 1977; Watson et al., 1980a,b). The reference values, defined in (3.25), are those currently used in the international formulations adopted by the International Association for the Properties of Steam (Nagashima, 1977; Schmidt, 1979; Meyer et al., 1980). These reference values are close to, but not equal to, the critical temperature and density of steam (Balfour et al., 1980). The parameters  $a_k$  in equation (3.23) for  $\lambda_o$  were earlier determined by Aleksandrov and Matveev (1976); they are reproduced in Table VIIA. A comparison of the equation for  $\lambda_o$  with the experimental thermal conductivity data of water vapor and steam at low densities was presented in a previous technical report (Sengers and Basu, 1977). The coefficients  $b_{1j}$  in equation (3.22) were determined by Watson (1978) in collaboration with the present authors; they are listed in Table VIB. Details of how these coefficients were obtained, as well as a comprehensive comparison of the equation with all available experimental data is presented elsewhere (Sengers et al., 1980).

To represent the thermal conductivity of steam in the critical region, we combine (3.22) with (3.13) and (3.15) using the parameter values

$$n = 1/2, \quad \Lambda = 1.20, \quad A_\lambda = 18.66, \quad B_\lambda = 1.00, \quad (3.26)$$

as adopted in an earlier analysis (Basu and Sengers, 1977) and using the critical region parameters presented in Section 2.5. The parameters for the fundamental equation for the thermodynamic properties of steam in the critical region, listed in Table V, enable us to calculate these properties in a region bounded by  $|\Delta T^*| \leq 0.05$  and  $|\Delta \rho^*| \leq 0.25$ . Outside this region we used the 1968 IFC Formulation

Table VII Coefficients in the equation for the  
normal thermal conductivity  $\bar{\lambda}$  of steam

VIIA The coefficients  $a_k^\lambda$

$a_0^\lambda = +2.022\ 23\ \text{m.K/W}$
$a_1^\lambda = +14.111\ 66\ \text{m.K/W}$
$a_2^\lambda = +5.255\ 97\ \text{m.K/W}$
$a_3^\lambda = -2.018\ 70\ \text{m.K/W}$

VIIB The coefficients  $b_{ij}^\lambda$

i \ j	0	1	2	3	4
0	+1.329 304 6	+1.701 836 3	+5.224 615 8	+8.712 767 5	-1.852 599 9
1	-0.404 524 37	-2.215 684 5	-10.124 111	-9.500 061 1	+ 0.934 046 90
2	+0.244 094 90	+1.651 105 7	+4.987 468 7	+4.378 660 6	0.0
3	+0.018 660 751	-0.767 360 02	-0.272 976 94	-0.917 837 82	0.0
4	-0.129 610 68	+0.372 833 44	-0.430 833 93	0.0	0.0
5	+0.044 809 953	-0.112 031 60	+0.133 338 49	0.0	0.0

for Scientific and General use (IFC, 1968; Rivkin et al., 1978). The viscosity was calculated from the international formulation adopted by the International Association for the Properties of Steam (Hendricks et al., 1977; Nagashima, 1977). The experimental thermal conductivity data were originally obtained by Sirota et al. (1974, 1976) as a function of pressure. The densities were then calculated from the experimental pressures and temperatures with the use of the equation of state data. However, the maxima in the thermal conductivity isobars as a function of density as reported by Sirota et al. do not seem to approach the critical density as observed for other fluids such as  $\text{CO}_2$ . The analysis does depend on the value adopted for  $T_c$  which was not determined in the experiments of Sirota et al. We, therefore, recalculated the densities, treating  $T_c$  as an adjustable parameter and selecting  $T_c = 646.923 \text{ K}$  as discussed elsewhere (Basu and Sengers, 1977). A comparison of our representative equation with the experimental thermal conductivity data at the recalculated densities is shown in Fig. 8.

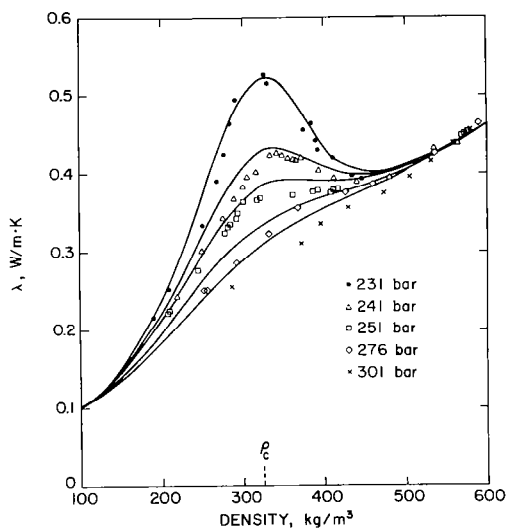

Fig. 8 Thermal conductivity data for steam in the critical region at four different isobars, measured by Sirota et al. (1974, 1976). The curves indicate the values calculated from the representative equation proposed in this report.



The equation for the thermal conductivity of steam presented here was adopted by the International Association for the Properties of Steam as the recommended interpolating equation for scientific use (Kestin, 1978, 1980; Scheffler et al., 1979; Schmidt, 1979; Meyer et al., 1980). Further details will be presented in a forthcoming publication (Sengers et al., 1980).

### 3.3 Viscosity

#### 3.3.1 Viscosity equation

The asymptotic power law (3.9) for the critical viscosity enhancement is expected to become valid at temperatures and densities sufficiently close to the critical point such that  $q\xi \gg 1$ . In order to describe the critical viscosity enhancement more completely, one should, in principle, include deviations from this asymptotic behavior (Oxtoby and Gelbart, 1974). However, since the critical viscosity enhancement is weak and limited to a small range of temperatures anyway, we take here a practical approach by adopting (3.9) for all values  $q\xi > 1$ , but treating  $q$  and  $\phi$  as adjustable parameters to be deduced from the experimental data. Furthermore, to connect the behavior of the viscosity close to the critical point with that of the normal viscosity away from the critical point, we neglect the critical viscosity enhancement for  $q\xi \leq 1$ . Thus we adopt

$$\begin{aligned} \eta &= \bar{\eta}(q\xi)^\phi & \text{for } q\xi > 1 & , \\ \eta &= \bar{\eta} & \text{for } q\xi \leq 1 & . \end{aligned} \quad (3.27)$$

Using (2.20) we can also write this viscosity equation in the form

$$\begin{aligned} \frac{\eta}{\bar{\eta}} &= (\chi_T^*/\chi_o^*)^{\nu\phi/\gamma} & \text{for } \chi_T^* > \chi_o^* & , \\ \frac{\eta}{\bar{\eta}} &= 1 & \text{for } \chi_T^* \leq \chi_o^* & , \end{aligned} \quad (3.28)$$

with

$$\chi_o^* = \Gamma/(q\xi_o)^\gamma . \quad (3.29)$$

#### 3.3.2 Viscosity of nitrogen

To test the applicability of the proposed viscosity equation we consider a few selected fluids for which adequate experimental information is available.

Zozulya and Blagoi (1974) have reported experimental data for the viscosity of nitrogen near the critical point. The viscosity was measured as a function of density directly; the usual additional uncertainties associated with the conversion of experimental pressures into densities are thus avoided. Zozulya and Blagoi determined the viscosity as a function of density along 14 isotherms covering the range  $126.16 \text{ K} \leq T \leq 135.00 \text{ K}$ . The critical temperature was estimated as  $T_c = (126.21 \pm 0.01) \text{ K}$ . A critical viscosity enhancement was observed in a temperature range of about 3 K above the critical temperature at densities between  $250 \text{ kg/m}^3$  and  $375 \text{ kg/m}^3$  ( $\rho_c = 313.9 \text{ kg/m}^3$ ). Some of the experimental data are shown in Fig. 9.

To represent the viscosity in the critical region we need to combine the equation proposed for the viscosity ratio  $\eta/\bar{\eta}$  with an equation for the normal viscosity  $\bar{\eta}$ . For this purpose we adopted a representative equation proposed by Hanley et al. (1974a); using this equation we converted the experimental viscosity data into viscosity ratios  $\eta/\bar{\eta}$ .

The viscosity ratios  $\eta/\bar{\eta}$  are plotted in Fig. 10 as a function of the correlation length  $\xi$  evaluated by the method described in Section 2.6. We note that on a double logarithmic scale the data approach a straight line for  $q\xi > 1$ . The slope of this line yields the exponent  $\phi$  and the intercept with the  $\xi$ -axis the constant  $q^{-1}$ . We thus obtain (Basu and Sengers, 1979)

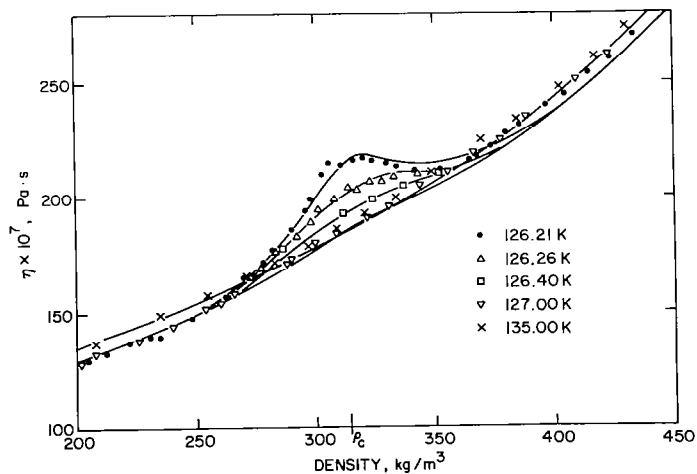

Fig. 9 Viscosity data for nitrogen in the critical region as measured by Zozulya and Blagoi (1974). The curves indicate the values calculated from the proposed viscosity equation with  $T_c = 126.201 \text{ K}$ .

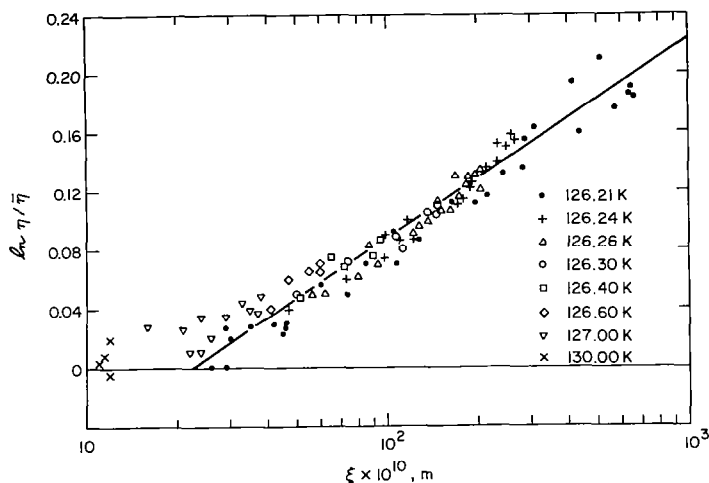

Fig. 10 Log-log plot of the viscosity ratio  $\eta/\bar{\eta}$  as a function of the correlation length  $\xi$  for nitrogen in the critical region.

$$q^{-1} = 22 \times 10^{-10} \text{ m}, \quad \phi = 0.057 \quad (T_c = 126.201 \text{ K}) \quad , \quad (3.30)$$

so that, with the parameters in Table IV,

$$\chi_o^* = 10.1 \quad , \quad v\phi/\gamma = 0.0303 \quad . \quad (3.31)$$

The viscosities, calculated from (3.30) with the parameter values (3.31), are represented by the curves in Fig. 9. For further details the reader is referred to a separate publication (Basu and Sengers, 1979).

### 3.3.3 Viscosity of steam

The viscosity of steam in the critical region was investigated experimentally by Rivkin et al. (1975). They determined the kinematic viscosity  $\eta/\rho$  as a function of temperature and pressure. We converted the experimental pressures into values for the density  $\rho$  using the equations presented in Section 2.5 and assuming in the analysis  $T_c = 647.073 \text{ K}$  as discussed elsewhere (Basu et al., 1980b; Watson et al., 1980b). The values thus deduced for the dynamic viscosity as a function of  $\rho$  are shown in Fig. 11.

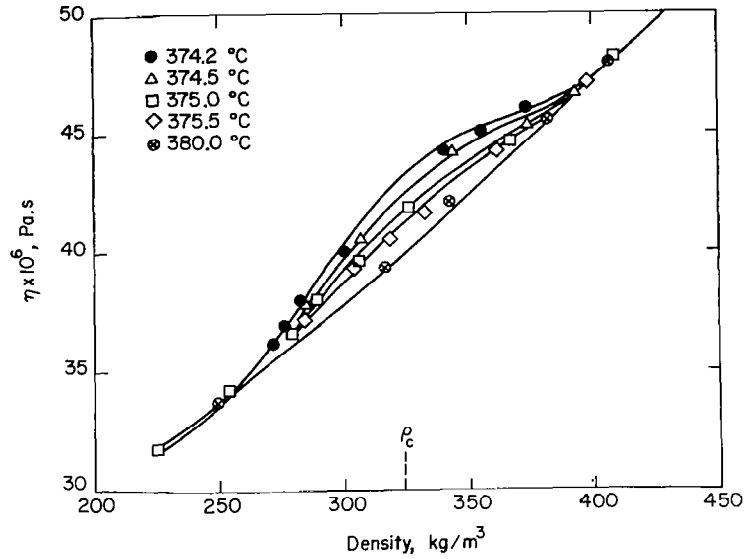

Fig. 11 Viscosity data for steam in the critical region (Rivkin et al. 1975; Watson et al., 1980). The curves indicate the values calculated from the proposed viscosity equation with  $T_c = 647.033$  K.

To represent the normal viscosity  $\bar{\eta}$  we adopted an equation analogous to the equation presented in Section 3.2.3 for the normal thermal conductivity  $\bar{\lambda}$  of steam

$$\bar{\eta} = \eta_o(\bar{T}) \exp \bar{\rho} \sum_{i=0}^5 \sum_{j=0}^6 b_{ij}^{\eta} \left(\frac{1}{\bar{T}} - 1\right)^i (\bar{\rho} - 1)^j, \quad (3.32)$$

with

$$\eta_o(\bar{T}) = \bar{T}^{1/2} / \sum_{k=0}^3 \frac{a_k^{\eta}}{\bar{T}^k}, \quad (3.33)$$

and where  $\bar{T}$  and  $\bar{\rho}$  are the dimensionless variables earlier defined in (3.24). This equation has the same form as the viscosity equation adopted by the International Association for the Properties of Steam (Aleksandrov, 1977; Hendricks et al., 1977; Nagashima, 1977; Scheffler et al., 1978; Schmidt, 1979; Meyer et al., 1980). For the coefficients  $a_k^{\eta}$  in (3.32) we retained the values

earlier determined by Aleksandrov et al. (1975) and incorporated in the current international viscosity equation; they are reproduced in Table VIIIA. However, we found that the number of nonvanishing coefficients  $b_{ij}^\eta$  could be reduced significantly as compared to the number of terms retained in the international viscosity equation. The coefficients  $b_{ij}^\eta$  were redetermined in collaboration with Watson and they are listed in Table VIIIB (Watson et al., 1980a,b).

Table VIII    Coefficients in the equation for the  
normal viscosity  $\bar{\eta}$  of steam

VIIIA The coefficients  $a_k^\eta$

$a_0^\eta = +0.018\ 1583 \times 10^6 \text{ Pa}^{-1} \text{ s}^{-1}$
$a_1^\eta = +0.017\ 7624 \times 10^6 \text{ Pa}^{-1} \text{ s}^{-1}$
$a_2^\eta = +0.010\ 5287 \times 10^6 \text{ Pa}^{-1} \text{ s}^{-1}$
$a_3^\eta = -0.003\ 6744 \times 10^6 \text{ Pa}^{-1} \text{ s}^{-1}$

VIIIB The coefficients  $b_{ij}^\eta$

i \ j	0	1	2	3	4	5
0	+0.513 2047	+0.320 5656	0.0	0.0	-0.778 2567	+0.188 5447
1	+0.215 1778	+0.731 7883	+1.241 044	+1.476 783	0.0	0.0
2	-0.281 8107	-1.070 786	-1.263 184	0.0	0.0	0.0
3	+0.177 8064	+0.460 5040	+0.234 0379	-0.492 4179	0.0	0.0
4	-0.041 7661	0.0	0.0	+0.160 0435	0.0	0.0
5	0.0	-0.015 7839	0.0	0.0	0.0	0.0
6	0.0	0.0	0.0	-0.003 6295	0.0	0.0

A plot of the viscosity ratios  $\eta/\bar{\eta}$ , thus deduced from the experimental data, as a function of the correlation length  $\xi$  is shown in Fig. 12.

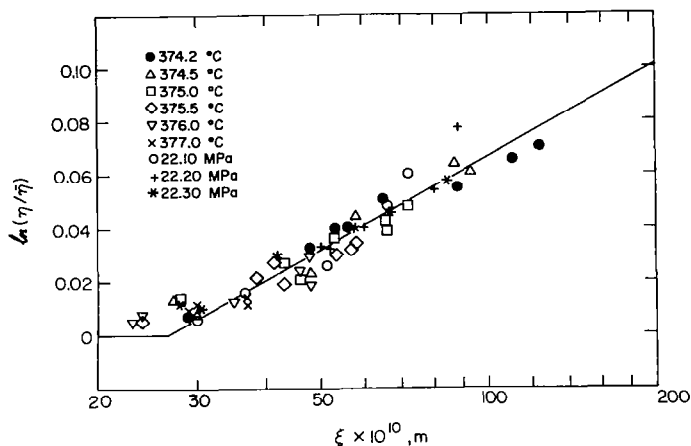

Fig. 12 Log-log plot of the viscosity ratio  $\eta/\bar{\eta}$  as a function of the correlation length  $\xi$  for steam in the critical region.

The line corresponds to the parameters (Basu et al, 1980b)

$$q^{-1} = 26.6 \times 10^{-10} \text{ m}, \quad \phi = 0.05 \quad (T_c = 647.073 \text{ K}) \quad , \quad (3.34)$$

which, when combined with the parameters presented in Table V, implies

$$\chi_0^* = 21.4 \quad v\phi/\gamma = 0.0263 \quad . \quad (3.35)$$

The viscosities, calculated from (3.28) with the parameter values (3.35) are represented by the curves in Fig. 11. A comprehensive comparison of this viscosity equation with experimental viscosity data of water and steam over a large range of temperatures and densities is presented elsewhere (Watson et al., 1980b).

#### 4. Discussion

##### 4.1 Recommendations for calculating the thermal conductivity in the critical region.

In this report an attempt was made to formulate representative equations that describe the singular behavior of the transport properties in terms of the singular behavior of the thermodynamic properties.

The thermal conductivity exhibits a critical enhancement in a large range of temperatures and densities around the critical point. In order to estimate this enhancement the thermal conductivity  $\lambda$  was separated into a normal contribution  $\bar{\lambda}$  and a critical enhancement  $\Delta\lambda$

$$\lambda = \bar{\lambda} + \Delta\lambda \quad . \quad (4.1)$$

To estimate the critical enhancement we introduced an equation of the form (see (3.15))

$$\Delta\lambda = \frac{\Lambda}{\Xi_0} \frac{k_B P_c}{6\pi\eta} \left(\frac{T^*}{\rho^*}\right)^2 \left(\frac{\partial P^*}{\partial T^*}\right)_{\rho^*}^2 \chi_T^* (\gamma - \nu) / \gamma \rho^{*n} \exp \left[ - \{A_\lambda (\Delta T^*)^2 + B_\lambda (\Delta \rho^*)^4\} \right]. \quad (4.2)$$

This equation relates the thermal conductivity enhancement at a given temperature and density to the pressure coefficient  $(\partial P / \partial T)_\rho$ , the symmetrized compressibility  $\chi_T$  and the (normal) shear viscosity  $\eta$ .

A calculation of the thermal conductivity enhancement  $\Delta\lambda$  as a function of temperature and pressure involves the following steps.

- a) Calculate the density at the given temperature and pressure from the equation of state.
- b) Calculate  $(\partial P / \partial T)_\rho$  and  $\chi_T$  at the given temperature and density from the equation of state.
- c) Calculate the (normal) viscosity  $\eta$  at the given temperature and density. In this procedure the critical viscosity enhancement may be neglected and most available engineering equations for the viscosity  $\eta$  will be adequate for the purpose.

In this report we formulated a detailed procedure for calculating  $\Delta\lambda$  of carbon dioxide and steam in the critical region. This procedure uses available scaled equations of state for these substances in the critical region.

A recommended procedure yielding estimates for the thermal conductivity of other fluids is presented in Table IX. We emphasize that this procedure is an approximate method for predicting the thermal conductivity enhancement. In

particular, the constants  $A_\lambda$  and  $B_\lambda$  in (4.2) will depend somewhat on the choice of the fluid. In the absence of further information we recommend that the values of these constants adopted for  $\text{CO}_2$  be used for the other fluids as well. The recommended procedure was used by Hanley et al. (1974, 1975, 1977) to estimate the thermal conductivity enhancement for a number of fluids.

Table IX. Procedure for estimating the critical thermal conductivity enhancement at given temperature and pressure

1. Calculate  $\rho^*$  and  $(\partial P^*/\partial T^*)_\rho$  from best available equation of state.
2. If  $\rho^*$  and  $T^*$  are outside the region bounded by (2.17), calculate  $\chi_T^*$  from best available equation of state.  
If  $\rho^*$  and  $T^*$  are inside the region bounded by (2.17), calculate  $\chi_T^*$  from (2.11) with parameter values from Table IV.
3. Calculate  $\Xi_o = \xi_o / \Gamma^{v/\gamma} = \xi_o (a/k)^{v/\gamma}$  with parameter values from Table IV.
4. Calculate the viscosity  $\eta$  from the best available equation for the normal viscosity, neglecting any critical viscosity enhancement effects.
5. Calculate  $\Delta\lambda$  from (4.2) with the values  $n=0$ ,  $\Lambda=1.02$ ,  $A_\lambda = 39.8$ ,  $B_\lambda = 5.45$  earlier adopted for  $\text{CO}_2$  (see (3.21)).

Because of the divergent nature of the thermal conductivity at the critical point, the calculated thermal conductivities in the near-critical region are sensitive to the choice for the critical temperature and pressure. Roughly speaking, if the critical temperature is uncertain by a relative amount  $\delta T_c^*$ , then the calculated values become inaccurate in a range bounded approximately by

$$|\Delta T^*| \leq |10\delta T_c^*|, \quad |\Delta \rho^*| \leq |10\delta T_c^*|^\beta \quad (4.3)$$

Since at the critical point  $(\partial P^*/\partial T^*)_\rho \approx 6$ , a relative error  $\delta P^*$  in the critical pressure has about the same effect as  $1/6$  times the same relative error  $\delta T_c^*$  in the critical temperature.



#### 4.2 Recommendations for calculating the viscosity in the critical region

The critical viscosity enhancement is weak and can only be observed at temperatures within a few percent from the critical temperatures. Hence, the effect may be neglected in most engineering applications as was done in the international representation recently adopted for the viscosity of steam (Aleksandrov, 1977; Hendricks et al, 1977, Nagashima, 1977; Scheffler et al, 1978; Schmidt, 1979; Meyer et al., 1980). In this report we showed how the critical viscosity enhancement can be accounted for in the case of nitrogen and steam. For other fluids it only makes sense if the density  $\rho$  and the normal viscosity  $\bar{\eta}$  in the critical region are known with considerable accuracy.

An estimate of the critical viscosity enhancement can be obtained from (3.27)

$$\ln(\eta/\bar{\eta}) = \phi \ln(q\xi) \Theta(q\xi-1) \quad , \quad (4.4)$$

where  $\Theta(z)$  is the Heaviside step function such that  $\Theta(z) = 1$  for  $z > 0$  and  $\Theta(z) = 0$  for  $z \leq 0$ . The correlation length  $\xi$  can be calculated from (2.20). In the absence of more detailed information, we recommend  $\phi \approx 0.05$ , while  $q$  may be estimated from an approximate equation (Basu and Sengers, 1979)

$$q \approx \frac{k_B P_c}{8\pi\bar{\eta}_c \bar{\lambda}_c} \left( \frac{\partial P^*}{\partial T^*} \right)_\rho^2 \frac{\Gamma}{\xi_o^2} \quad , \quad (4.5)$$

where  $\bar{\eta}$  and  $\bar{\lambda}$  are the normal viscosity and normal thermal conductivity at the critical point. Using the rule of thumb  $(\partial P^*/\partial T^*)_\rho \approx 6$ , we approximate (4.5) by

$$q \approx \frac{9k_B P_c \Gamma}{2\pi\bar{\eta}_c \bar{\lambda}_c \xi_o^2} = \frac{9k_B P_c k}{2\pi\bar{\eta}_c \bar{\lambda}_c a \xi_o^2} \quad . \quad (4.6)$$

The procedure is summarized in Table X.

Table X. Procedure for estimating the critical viscosity enhancement at given temperature and density

1. Calculate  $\bar{\eta}$  from best available equation for the normal viscosity.
2. If  $\rho^*$  and  $T^*$  are outside the region bounded by (2.17), take  $\eta = \bar{\eta}$  and stop.  
If  $\rho^*$  and  $T^*$  are inside the regions bounded by (2.17), continue.
3. Calculate  $\xi = \xi_0 (\chi_T^*/\Gamma)^{\nu/\gamma} = \xi_0 (\chi_T^* a/k)^{\nu/\gamma}$  from (2.11) with parameter values from Table IV.
4. Calculate  $\bar{\lambda}_c$  and  $\bar{\eta}_c$  from best available equations for the normal thermal conductivity and viscosity.
5. Calculate  $q$  from (4.6).
6. Calculate  $\eta = \bar{\eta}(q\xi)^{0.05}$  wherever  $q\xi > 1$ .

### 4.3 Outlook

In this report we have presented simple approximate equations for the compressibility, the thermal conductivity and the viscosity of fluids in the critical regions. There are a number of ways available by which the quality of the representative equations can be improved.

First, it is possible to formulate a revised and extended scaled equation of state with a priori known theoretical values of the critical exponents and valid in a larger range than the scaled equation of state considered in this report (Balfour et al, 1977, 1978). Parameter values for such a revised and extended scaled equation of state have been determined in the case of steam (Balfour et al. 1980) and in the case of ethylene (Hastings et al., 1980) and parameter values in the case of other fluids are expected to become available in the future.

For a completely satisfactory description one would like to formulate a global equation of state that smoothly connects the scaling laws in the critical region with the known analytic surface valid away from the critical region. This problem requires further study as discussed elsewhere (Levelt Sengers and Sengers, 1980).

In order to connect the critical enhancement in the transport properties with the normal behavior of the transport properties we introduced an empirical crossover function (3.13) for the thermal conductivity and a Heaviside step function (see (4.4)) for the viscosity. It is possible to introduce better crossover functions from a more detailed examination of the mode-coupling equation for the critical enhancement of the thermal conductivity and the viscosity. This work is currently in progress.<sup>†</sup>

---

<sup>†</sup>This work is done in collaboration with Bhattacharjee and Ferrell.

## References

- Aharony, A. and G. Ahlers (1980), Phys. Rev. Lett. 44, 782.
- Aleksandrov, A. A. (1977), Thermal Engineering 24 (4), 76.
- Aleksandrov, A. A., A. I. Ivanov and A. B. Matveev (1975), Thermal Engineering 22 (4), 77.
- Aleksandrov, A. A. and A. B. Matveev (1976), "Equation for Thermal Conductivity of Water in the Wide Range of Temperatures and Pressures", Report submitted to the Special Committee of IAPS (International Association for the Properties of Steam).
- Baker, G. A., B. G. Nickel and D. I. Meiron (1978), Phys. Rev. B 17, 1365.
- Balfour, F. W., J. V. Sengers, M. R. Moldover and J. M. H. Levelt Sengers (1977), in Proceedings 7th Symposium on Thermophysical Properties, A. Cezairliyan, ed. (American Society of Mechanical Engineers, New York), p. 786.
- Balfour, F. W., J. V. Sengers, M. R. Moldover and J. M. H. Levelt Sengers (1978), Phys. Lett. 65A, 223.
- Balfour, F. W., J. V. Sengers and J. M. H. Levelt Sengers (1980), in Water and Steam: Their Properties and Current Industrial Applications, J. Straub and K. Scheffler, eds. (Pergamon Press, Oxford and New York), p. 128.
- Barber, M. N. (1977), Phys. Reports 29C, 1.
- Basu, R. S. and J. V. Sengers (1977), in Proc. 7th Symposium on Thermophysical Properties, A. Cezairliyan, ed. (American Society of Mechanical Engineers, New York), p. 822.
- Basu, R. S. and J. V. Sengers (1979), J. Heat Transfer, Trans ASME 101, 3; 101, 575.
- Basu, R. S. and J. V. Sengers (1980) in Thermal Conductivity - 16, D. C. Larsen, ed. (Plenum Publ. Corp., New York), in press.
- Basu, R. S., J. V. Sengers and J. T. R. Watson (1980), Intern. J. Thermophys. 1, 33.
- Becker, H. and U. Grigull (1975), Maschinenmarkt 81, 50.
- Becker, H. and U. Grigull (1978), Wärme - und Stoffübertragung 11, 9.
- Benedek, G. B. (1968), in Statistical Physics, Phase Transitions and Superfluidity, Vol. 2, M. Chrétien, E. P. Gross and S. Deser, eds. (Gordon and Breach, New York), p. 1.

References (cont'd.)

- Burstyn, H. C., J. V. Sengers and P. Esfandiari (1980), Phys. Rev. A 22, 282.
- Calmettes, P. (1977), Phys. Rev. Lett. 39, 1151.
- Cummins, H. Z. and H. L. Swinney (1970) in Progress in Optics, Vol. 8, E. Wolf, ed. (North Holland Publ. Comp., Amsterdam), p. 135.
- De Dominicis, C. and L. Peliti (1978), Phys. Rev. B 18, 353.
- De Pasquale, F., P. Tartaglia and P. Tombesi, (1978), J. Phys. A 11, 2033.
- Diller, D. E., Hanley, H. J. M. and Roder, H. M. (1970), Cryogenics 10, 268.
- Domb, C. and M. S. Green, eds. (1976), Phase Transitions and Critical Phenomena, Vol. 6 (Academic Press, New York).
- Douglass, T. B. (1969), J. Res. Natl. Bur. Stand. 73A, 541.
- Ernst, M. H. (1978), in Fundamental Problems in Statistical Mechanics IV, E. G. D. Cohen and W. Fiszdon, eds. (Zaklad Narodowy um Ossolinskich-Wydawnictwo, Wroclaw, Poland), p. 161.
- Ferrell, R. A. (1970), Phys. Rev. Lett. 24, 1169.
- Fleury, P. A. and J. P. Boon, (1973) Adv. Chem. Phys. 24, 1.
- Greer, S. C. (1978), Acc. Chem. Res. 11, 427.
- Griffiths, R. B. (1967), Phys. Rev. 158, 176.
- Güttlinger, H. and D. S. Cannell (1980), Phys. Rev. A. 22, 285.
- Gunton, J. D. (1979), in Dynamical Critical Phenomena and Related Topics, C. P. Enz, ed. (Springer Verlag, Berlin, Heidelberg, New York), p. 1.
- Gunton, J. D. and K. Kawasaki, (1976), Progr. Theor. Phys. 56, 61.
- Hanley, H. J. M., R. D. McCarty and E. G. D. Cohen (1972), Physica 60, 322.
- Hanley, H. J. M., R. D. McCarty and W. M. Haynes (1974a), J. Phys. Chem. Ref. Data 3, 979.
- Hanley, J. H. M., K. E. Gubbins and S. Murad (1977), J. Phys. Chem. Ref. Data 6, 1167.
- Hanley, H. J. M., R. D. McCarty and W. M. Haynes (1975), Cryogenics 15, 413.

## References (cont'd.)

- Hanley, H. J. M., R. D. McCarty and J. V. Sengers (1974b), "Viscosity and Thermal Conductivity Coefficients of Gaseous and Liquid Oxygen", NASA Contractor Report 2440 (National Aeronautics and Space Administration, Washington, D.C.).
- Hanley, H. J. M., J. V. Sengers and J. F. Ely (1976), in Thermal Conductivity - 14, P. G. Klemens and T. K. Chu, Eds. (Plenum Publ. Corp., New York), p. 383.
- Hastings, J. R., J. M. H. Levelt Sengers and F. W. Balfour (1980), J. Chem. Thermodynamics 12, 1009.
- Hendricks, R. C., R. B. McClintock and G. J. Silvestri (1977), J. Eng. Power, Trans. ASME 99, 664.
- Hohenberg, P. C. and M. Barmatz (1972), Phys. Rev. A 6, 289.
- Hohenberg, P. C. and B. I. Halperin (1977), Rev. Mod. Phys. 49, 435.
- Hubbard, J. and P. Schofield (1972), Phys. Lett. 40A, 245.
- IFC (1968), "The 1968 IFC Formulation for Scientific and General Use" (American Society of Mechanical Engineers, New York).
- Kadanoff, L. P. and J. Swift (1968), Phys. Rev. 166, 89.
- Kawasaki, K. (1970), Annals of Physics 61, 1.
- Kawasaki, K. (1971), in Critical Phenomena, Proc. Intern. School "Enrico Fermi", Course LI, M. S. Green, ed. (Academic Press, New York), p. 342.
- Kawasaki, K. (1976) in Phase Transitions and Critical Phenomena, Vol. 5A, C. Domb and M. S. Green, eds. (Academic Press, New York), p. 165.
- Kawasaki, K. and J. D. Gunton (1976), Phys. Rev. B 13, 4658.
- Kestin, J. (1978), Mechanical Engineering 100 (8), 46.
- Kestin, J. (1980), in Water and Steam: Their Properties and Current Industrial Applications, J. Straub and K. Scheffler, eds. (Pergamon Press, Oxford and New York), p. 283.
- Le Guillou, J. C. and J. Zinn-Justin (1977), Phys. Rev. Lett. 39, 95.
- Le Guillou, J. C. and J. Zinn-Justin (1980), Phys. Rev. B 21, 3976.
- Le Neindre, B., R. Tufeu, P. Bury and J. V. Sengers (1973), Ber. Bunsenges. physik. Chemie 77, 262.
- Levelt Sengers, J. M. H. (1974), Physica 73, 73.

- Levelt Sengers, J. M. H. (1977a), in Proc. 7th Symposium on Thermophysical Properties, A. Cezairliyan, ed. (American Society of Mechanical Engineers, New York), p. 766.
- Levelt Sengers, J. M. H. (1977b), in Proc. 7th Symposium on Thermophysical Properties, A. Cezairliyan, ed. (American Society of Mechanical Engineers, New York), p. 774.
- Levelt Sengers, J. M. H. and W. T. Chen (1972), *J. Chem. Phys.* 56, 595.
- Levelt Sengers, J. M. H., W. L. Greer and J. V. Sengers (1976), *J. Phys. Chem. Ref. Data* 5, 1.
- Levelt Sengers, A., R. Hocken and J. V. Sengers (1977), *Physics Today* 30 (12), 42.
- Levelt Sengers, J. M. H. and J. V. Sengers (1975), *Phys. Rev. A* 12, 2622.
- Levelt Sengers, J. M. H. and J. V. Sengers (1980), in Perspectives in Statistical Physics, M. S. Green Memorial Issue of "Studies in Statistical Mechanics", H. J. Raveché, ed. (North-Holland Publ. Comp., Amsterdam), in press.
- Ley-Koo, M. and M. S. Green (1977), *Phys. Rev. A* 16, 2483.
- Mazenko, G. F. (1978), in Correlation Functions and Quasiparticle Interactions, J. W. Halley, ed. (Plenum Press, New York), p. 1.
- McIntyre, D. and J. V. Sengers (1968), in Physics of Simple Liquids, H. N. V. Temperley, J. S. Rowlinson and G. S. Rushbrooke, eds. (North Holland Publ. Comp., Amsterdam), p. 447.
- Meyer, C. A., R. B. McClintock, G. J. Silvestri and R. C. Spencer (1980), ASME Steam Tables, 4th ed. (American Society of Mechanical Engineers, New York).
- Michels, A., B. Blaisse and C. Michels (1937), *Proc. Roy. Soc. (London) A* 160, 358.
- Michels, A. and S. R. de Groot (1948), *Appl. Sci. Res. A* 1, 94.
- Michels, A. and C. Michels (1935), *Proc. Roy. Soc. (London) A* 153, 201.
- Michels, A. and C. Michels (1937), *Proc. Roy. Soc. (London) A* 160, 348.
- Michels, A., J. V. Sengers and P. S. van der Gulik (1962), *Physica* 28, 1216.
- Michels, A. and J. C. Strijland (1952), *Physica* 18, 613.
- Moldover, M. R. (1974), *J. Chem. Phys.* 61, 1766.

- Moldover, M. R. (1978), J. Res. Natl. Bur. Stand. 83, 329.
- Mountain, R. D. (1966), Rev. Mod. Phys. 38, 205.
- Murphy, T. A., J. V. Sengers and J. M. H. Levelt Sengers (1973), in Proc. 6th Symposium on Thermophysical Properties, P. E. Liley, ed. (American Society of Mechanical Engineers, New York), p. 180.
- Murphy, T. A., J. V. Sengers and J. M. H. Levelt Sengers (1975), in Proc. 8th International Conference on the Properties of Water and Steam, P. Bury, H. Perdon and B. Vodar, eds. (Editions Européennes Thermiques et Industries, Paris), p. 603.
- Nagashima, A. (1977), J. Phys. Chem. Ref. Data 6, 1133; 7, 1755.
- Nicoll, J. F. (1980), Phys. Lett. 76A, 112.
- Nicoll, J. F. and T. S. Chang (1978), Phys. Rev. A 17, 2083.
- Ohta, T. (1975), Progr. Theor. Phys. 54, 1566.
- Ohta, T. (1977), J. Phys. C 10, 791.
- Ohta, T. and K. Kawasaki (1976), Progr. Theor. Phys. 55, 1348.
- Oxtoby, D. W. and W. M. Gelbart (1974), J. Chem. Phys. 61, 2957.
- Perl, R. and R. A. Ferrell (1972), Phys. Rev. A 6, 2358.
- Pfeuty, P. and G. Toulouse (1977), Introduction to the Renormalization Group and to Critical Phenomena (Wiley, New York).
- Pomeau, Y. and P. Résibois (1975), Phys. Reports 19C, 63.
- Rivkin, S. L. and T. S. Akhundov (1962), Teploenergetika 9 (1), 57.
- Rivkin, S. L. and T. S. Akhundov (1963), Teploenergetika 10 (9), 66.
- Rivkin, S. L., T. S. Akhundov, E. A. Kremenevskaya and N. N. Assadulaieva (1966), Thermal Engineering 13 (4), 77.
- Rivkin, S. L., A. A. Aleksandrov and E. A. Kremenevskaya (1978), Thermodynamic Derivatives for Water and Steam (Wiley, New York).
- Rivkin, S. L., A. Ya. Levin, L. B. Izrailevsky and K. G. Kharitonov (1975), in Proc. 8th International Conference on the Properties of Water and Steam, P. Bury, H. Perdon and B. Vodar eds. (Editions Européennes Thermiques et Industries, Paris), p. 153.



Scheffler, K., N. Rosner, J. Straub and U. Grigull (1978), Brennst - Wärme - Kraft 30, 73.

Scheffler, K., N. Rosner, J. Straub and U. Grigull (1979), Brennst - Wärme - Kraft 31, 326.

Schmidt, E. (1979), Properties of Water and Steam in SI - Units, 2nd ed., U. Grigull, ed. (Springer Verlag, Berlin, Heidelberg, New York).

Schmitt, H. and H. Beer (1977), Brennst - Wärme - Kraft 29, 15.

Schofield, P. (1969), Phys. Rev. Lett. 22, 606.

Schofield, P., J. D. Litster and J. T. Ho (1969), Phys. Rev. Lett 23, 1098.

Scott, R. L. (1978), in Chemical Thermodynamics, Vol. 2, Specialist Periodical Report, M. L. McGlashan, ed. (Chemical Society, London), p. 238.

Sengers, J. V. (1966), in Critical Phenomena, NBS Misc. Publ. 273, M. S. Green and J. V. Sengers, eds. (U.S. Gov't. Printing Office, Washington, D.C.), p. 165.

Sengers, J. V. (1968), in Recent Advances in Engineering Science, Vol. 3, A. C. Eringen, ed. (Gordon and Breach, New York, 1968), p. 153.

Sengers, J. V. (1971), in Critical Phenomena, Proc. Intern. School "Enrico Fermi", Course LI, M. S. Green, ed. (Academic Press, New York), p. 445.

Sengers, J. V. (1972), "Transport Properties of Gases and Binary Liquids near the Critical Point", NASA Contractor Report 2112 (National Aeronautics and Space Administration, Washington, D.C.). See also: Ber. Bunsenges. physik. Chemie 76, 234 (1972).

Sengers, J. V. (1973), in Transport Phenomena - 1973, AIP Conference Proceedings No. 11, J. Kestin, ed. (American Institute of Physics, New York), p. 229.

Sengers, J. V. and R. S. Basu (1977), "The thermal conductivity of steam in the zero density limit as a function of temperature", Technical Report BN 852 (Institute for Physical Science and Technology, University of Maryland, College Park, MD).

Sengers, J. V., R. S. Basu, J. T. R. Watson and R. C. Hendricks (1981), J. Phys. Chem. Ref. Data, to be published.

Sengers, J. V. and P. H. Keyes (1971), Phys. Rev. Lett. 26, 70.

Sengers, J. V. and J. M. H. Levelt Sengers, (1977), "Concepts and methods for describing critical phenomena in fluids", NASA Contractor Report 149665 (NASA Lewis Research Center, Cleveland, OH). With some minor modifications this report was published in Progress in Liquid Physics, C. A. Croxton, ed. (Wiley, New York, 1978), p. 103.

- Sengers, J. V. and M. R. Moldover (1978), Phys. Lett. 66A, 44.
- Siggia, E. D., B. I. Halperin and P. C. Hohenberg (1976), Phys. Rev. B 13, 2110.
- Sirota, A. M., V. I. Latunin and G. M. Belyaeva (1973), Thermal Engineering 20 (8), 7.
- Sirota, A. M., V. I. Latunin and G. M. Belyaeva (1974), Thermal Engineering 21 (10), 70.
- Sirota, A. M., V. I. Latunin and G. M. Belyaeva (1976), Thermal Engineering 23 (1), 72.
- Sirota, A. M., V. I. Latunin, G. M. Belyaeva and I. I. Bol'dshtein, (1976), Thermal Engineering 23 (6), 75.
- Vicentini-Missoni, M., J. M. H. Levelt Sengers and M. S. Green, (1969a), J. Res. Natl. Bur. Stand. 73A, 563.
- Vicentini-Missoni, M., J. M. H. Levelt Sengers and M. S. Green (1969b), Phys. Rev. Lett. 22, 389.
- Wallace, D. J. and R. K. P. Zia (1978), Rep. Prog. Phys. 41, 1.
- Watson, J. T. R. (1976a), "Dynamic viscosity of carbon dioxide gas and liquid", ESDU Data Item No. 76021 (Engineering Sciences Data Unit, London).
- Watson, J. T. R. (1976b), "Thermal conductivity of carbon dioxide gas and liquid", ESDU Data Item No. 76030 (Engineering Sciences Data Unit, London).
- Watson, J. T. R. (1978), "Thermal conductivity of ice, water and steam", ESDU Data Item No. 78039 (Engineering Sciences Data Unit, London).
- Watson, J. T. R., R. S. Basu and J. V. Sengers (1980a), in Water and Steam: Their Properties and Current Industrial Applications, J. Straub and K. Scheffler, eds. (Pergamon Press, Oxford and New York), p. 336.
- Watson, J. T. R., R. S. Basu and J. V. Sengers (1980b), J. Phys. Chem. Ref. Data, 9, 239.
- Waxman, M., H. A. Davis, J. M. H. Levelt Sengers and M. Klein (1978), "The equation of state of isobutane: An interim assessment", Nat'l. Bur. Stand. Internal Report, prepared for the Geothermal Energy Division of the U.S. Department of Energy.
- Wilson, K. G. and J. Kogut (1974), Phys. Reports 12C, 75.
- Zozulya, V. N. and Yu P. Blagoi (1974), JETP 39, 99.

## Appendix

Computer program for calculating the linear model parameters  $r$  and  $\theta$

```
C      SUBROUTINE DPARAM
C      AUTHOR T.A.MURPHY
C
C      PURPOSE
C      EVALUATE LINEAR MODEL PARAMETERS R AND THETA
C      FROM GIVEN TEMPERATURES AND DENSITY
C
C      USAGE
C      CALL DPARAM(DRS,DTS,MODE,XDS,B2S,BETAS,R,TH)
C
C      DESCRIPTION OF PARAMETERS
C      DRS = RHO/RHOC-1=REDUCED DENSITY-1
C      DTS = T/TC-1=REDUCED TEMPERATURES-1
C      RS,THS - LINEAR MODEL PARAMETERS R,THETA
C      BETAS - CRITICAL EXPONENT
C      XDS,B2S - FIXED PARAMETERS IN LINEAR MODEL
C      MODE - AN INDICATOR
C           = 1 IF DATA POINT IS INSIDE CXC
C           = 2 IF NEWTONS METHOD CANNOT FIND THETA
C           = 3 IF PARAMETERS R AND THETA ARE SUCCESSFULLY EVALUATED
C           = 4 IF THETA WAS FOUND BUT R FAILS CONSISTENCY TEST
C           = 5 IF THETA WAS FOUND BUT R BECOMES NEGATIVE
C
C      COMMENTS
C      THE PROGRAM USES DOUBLE PRECISION ARITHMETIC
C      DRS,DTS,BETAS,XDS,B2S SHOULD BE PROVIDED BY THE CALLING ROUTINE
C      THE VALUE OF R AND THETA IS RETURNED TO THE CALLING ROUTINE
C      THE INPUT PARAMETERS SHOULD BE IN SINGLE PRECISION
C      THE PROGRAM CONVERTS THEM TO DOUBLE PRECISION AND USES
C      DOUBLE PRECISION ARITHMETIC . RETURNS R,THETA IN DOUBLE
C      PRECISION
C
C      SUBROUTINES AND SUBPROGRAMS REQUIRED
C      NONE
C
C      SUBROUTINE DPARAM(DRS,DTS,MODE,XDS,B2S,BETAS,R,TH)
C      IMPLICIT REAL*8(A-H,O-Z)
C      REAL DRS,DTS,XDS,BETAS,B2S
C      I=1
C
C      IMAX = 100 GIVES THE MAXIMUM NUMBER OF ITERATIONS DONE
C      ERMASX SETS THE CRITERIA FOR CONVERGENCE
C
C      IMAX=100
C      DR = DRS
C      DT = DTS
C      XD = XDS
C      BETA = BETAS
C      B2 = B2S
C      ERMASX=1.E-13
C      B=SQRT(B2)
C      SGN=1.
C      IF(DP.LT.0.) SGN=-1.
C      IF(DR.EQ.0.) GO TO 200
C      IF(DT.EQ.0.) GO TO 100
C      X=DT/ABS(DR)**(1./BETA)
C      RX=ABS(X)
C      IF(X.LT.(-XD)) GO TO 400
C      IF(DT.GT.0.) GO TO 50
C
C      NEWTONS METHOD OF SOLUTION FOR VARIOUS VALUES OF DR AND DT
C
C      THETA=(1.+1./B)/2.
C      25 FX=RX*(B2-1.)*THETA**(1./BETA)/XD+1.-B2*THETA**2
C      FXP=RX*(B2-1.)*THETA**(1./BETA-1.)/(XD*BETA)-2.*B2*THETA
C      THETA=THETA-FX/FXP
C      IF(ABS(FX/(FXP*THETA)).LT.ERMASX) GO TO 300
C      IF(1.GT.IMAX) GO TO 500
C      I=I+1
C      GO TO 25
```

```

50 THETA =1./ (2.*B)
55 FX=AX*(B2-1.)*THETA*(1./BETA)/XD-1.+B2*THETA**2
   FXP=AX*(B2-1.)*THETA*(1./BETA-1.)/(XD*BETA)+2.*B2*THETA
   THETA=THETA-FX/FXP
   IF (ABS (FX/(FXP*THETA)).LT.ERMAX) GO TO 300
   I=I+1
   IF (I.GT.IMAX) GO TO 500
   GO TO 55
100 THETA=1./B*SGN
   TH=THETA
   MODE=3
   R=(DR/THETA)**(1./BETA)*XD/(B2-1.)
   RETURN
200 THETA=0.
   TH=THETA
   MODE=3
   R=DT
   IF (DT.LT.0.) GO TO 400
   RETURN
300 THETA=THETA*SGN
   TH=THETA
   DCUBR=DT/(1.-B2*THETA**2)
   R=DCUBR
   IF (DCUBR.LT.0.) GO TO 600
   DRCALC=(DCUBR*(B2-1.)/XD)**BETA*THETA
   IF (ABS (1.-DRCALC/DR).GT.1.E-10) GO TO 350
   MODE=3
   RETURN
350 MODE=4
   WRITE (6,9001) DRCALC,DR,DT,R,TH,XD,BETA,B2,I,MODE
   ERMAX=ERMAX/10000
9001  FORMAT ('OPRAMTR IN TROUBLE- MAY REQUIRE KILLING RUN',/,
14D24.18,/4D24.18,/,2I8)
   THETA=ABS (THETA)
   I=1
   IF (DT.GT.0.) GO TO 55
   GO TO 25
400 MODE=1
   TH=SGN
   DCUBR=DT/(1.-B2)
   R=DCUBR
   RETURN
500 MODE=2
550 WRITE (6,9002) DR,DT,R,TH,XD,BETA,B2,I,MODE
9002  FORMAT ('OPRAMTR FAILURE',/,7E14.8,/,2I8)
   RETURN
600 MODE=5
   GO TO 550
   END

```

1. Report No. NASA CR-3424	2. Government Accession No.	3. Recipient's Catalog No.	
4. Title and Subtitle <b>REPRESENTATIVE EQUATIONS FOR THE THERMODYNAMIC AND TRANSPORT PROPERTIES OF FLUIDS NEAR THE GAS-LIQUID CRITICAL POINT</b>		5. Report Date May 1981	6. Performing Organization Code
		8. Performing Organization Report No. <b>None</b>	
7. Author(s) J. V. Sengers, R. S. Basu, and J. M. H. Levelt Sengers		10. Work Unit No.	
9. Performing Organization Name and Address <b>Institute for Physical Science and Technology University of Maryland College Park, Maryland 20742</b>		11. Contract or Grant No. <b>NGR 21-002-344</b>	
		13. Type of Report and Period Covered <b>Contractor Report</b>	
12. Sponsoring Agency Name and Address <b>National Aeronautics and Space Administration Washington, D. C. 20546</b>		14. Sponsoring Agency Code <b>506-21-42</b>	
		15. Supplementary Notes J. V. Sengers and R. S. Basu, Univ. of Maryland, College Park, Maryland 20742; J. M. H. Levelt Sengers, Thermophysics Division, National Bureau of Standards, Washington, D. C., 20234. Work partially supported by the Office of Standard Reference Data at NBS. Final report. Project Manager, R. J. Simoneau, Aerothermodynamics and Fuels Division, Lewis Research Center, Cleveland, Ohio 44135.	
16. Abstract  A survey is presented of representative equations for various thermophysical properties of fluids in the critical region. The information complements the equations presented in NASA Contractor Report 149665 by the inclusion of representative equations for the transport properties. We emphasize semi-empirical modifications of the theoretically predicted asymptotic critical behavior that yield simple and practical representations of the fluid properties in the critical region.			
17. Key Words (Suggested by Author(s)) Critical phenomena; Equation of state; Transport properties; Thermodynamic properties; Thermal conductivity; Viscosity; Critical point universality		18. Distribution Statement Unclassified - unlimited STAR Category 77	
19. Security Classif. (of this report) <b>Unclassified</b>	20. Security Classif. (of this page) <b>Unclassified</b>	21. No. of Pages 59	22. Price* A04

\* For sale by the National Technical Information Service, Springfield, Virginia 22161