

# The Future of the Nuclear Fuel Cycle

AN INTERDISCIPLINARY MIT STUDY

The  
Future of  
the Nuclear  
Fuel Cycle

AN INTERDISCIPLINARY MIT STUDY

### **Other Reports in This Series**

The Future of Nuclear Power (2003)

The Future of Coal (2007)

Update of the Future of Nuclear Power (2009)

The Future of Natural Gas (2010)

Copyright © 2011 Massachusetts Institute of Technology. All rights reserved.

ISBN 978-0-9828008-4-3

# Study Participants

## **STUDY CO-CHAIRS**

Mujid Kazimi—Co CHAIR  
Tokyo Electric Professor of Nuclear Engineering  
Director, Center for Advanced Nuclear Energy  
Systems  
Department of Nuclear Science and Engineering  
Department of Mechanical Engineering

Ernest J. Moniz—Co CHAIR  
Department of Physics  
Cecil and Ida Green Prof of Physics and of  
Engineering Systems  
Director MIT Energy Initiative

Charles W. Forsberg  
Executive Director MIT Fuel Cycle Study  
Department of Nuclear Science and Engineering

## **STUDY GROUP**

Steve Ansolabehere  
Professor of Government, Harvard University

John M. Deutch  
Institute Professor  
Department of Chemistry

Michael J. Driscoll  
Professor Emeritus  
Department of Nuclear Science and Engineering

Michael W. Golay  
Professor of Nuclear Science and Engineering

Andrew C. Kadak  
Professor of the Practice  
Department of Nuclear Science and Engineering

John E. Parsons  
Senior Lecturer, Sloan School of Management, MIT  
Executive Director, Center for Energy and  
Environmental Policy Research and the Joint Program  
on the Science and Policy of Global Change

Monica Regalbuto  
Visiting Scientist, Department of Nuclear Science  
and Engineering  
Department Head, Process Chemistry and Engineering  
Argonne National Laboratory

## **CONTRIBUTING AUTHORS**

George Apostolakis  
Korea Electric Power Company Professor of  
Nuclear Engineering  
Department of Nuclear Science and Engineering  
Department of Engineering Systems

Pavel Hejzlar  
Program Director, CANES  
Principal Research Scientist  
Department of Nuclear Science and Engineering

Eugene Shwageraus  
Visiting Associate Professor  
Department of Nuclear Science and Engineering

## **STUDENT RESEARCH ASSISTANTS**

Blandine Antoine  
Guillaume De Roo  
Bo Feng  
Laurent Guerin  
Isaac Alexander Matthews  
Lara Pierpoint  
Behnam Taebi  
Keith Yost

# MIT Nuclear Fuel Cycle Study Advisory Committee Members

**PHIL SHARP, CHAIR**

President, Resources for the Future  
Former member of Congress

**JAMES K. ASSELSTINE**

Managing Director, Barclays Capital

**JACQUES BOUCHARD**

Advisor to the Chairman of the Commissariat à l'énergie atomique et aux énergies alternatives (CEA)

**MARVIN FERTEL**

President and CEO, Nuclear Energy Institute

**KURT GOTTFRIED**

Chairman Emeritus of the Union of Concerned Scientists

**JOHN GROSSENBACHER**

Director, Idaho National Laboratory

**JONATHAN LASH**

President, World Resources Institute

**RICHARD A. MESERVE**

President, Carnegie Institution for Science

**CHERRY MURRAY**

Dean of the School of Engineering and Applied Sciences, Harvard University

**JOHN W. ROWE**

Chairman and CEO, Exelon Corporation

**MAXINE L. SAVITZ**

Vice President, U.S. National Academy of Engineering

**STEVEN R. SPECKER**

President and CEO, Electric Power Research Institute (retired)

**JOHN H. SUNUNU**

JHS Associates, Ltd.

*While the members of the advisory committee provided invaluable perspective and advice to the study group, individual members may have different views on one or more matters addressed in the report. They were not asked to individually or collectively endorse the report findings and recommendations.*

*Daniel Poneman, Scowcroft Group, resigned from the committee upon his Presidential nomination for a government position.*

# Table of Contents

Study Participants	iii
MIT Nuclear Fuel Cycle Study Advisory Committee Members	iv
Foreword and Acknowledgments	vii
Executive Summary	ix
Postscript	xv
Chapter 1. The Future of the Nuclear Fuel Cycle— Overview, Conclusions, and Recommendations	1
Chapter 2. Framing Fuel Cycle Questions	19
Chapter 3. Uranium Resources	31
Chapter 4. Interim Storage of Spent Nuclear Fuel	43
Chapter 5. Waste Management	55
Chapter 6. Analysis of Fuel Cycle Options	71
Chapter 7. Economics	99
Chapter 8. Fuel Cycles and Nonproliferation	111
Chapter 9. American Attitudes About Nuclear Power and Nuclear Waste	127
Chapter 10. Recommended Analysis, Research, Development, and Demonstration Programs	133
<b>APPENDICES</b>	
Appendix to Chapter 3: Uranium Resource Elasticity Model	143
Appendix to Chapter 5: Waste Management	155
Appendix to Chapter 7: Economics	167
Appendix A. Thorium Fuel Cycle Options	181
Appendix B. Advanced Technologies	191
Appendix C. High-Temperature Reactors with Coated-Particle Fuel	207
Appendix D. Intergenerational Equity Considerations of Fuel Cycle Choices	213
Appendix E. Status of Fuel Cycle Technologies	229



# Foreword and Acknowledgments

In 2003 the MIT interdisciplinary study *The Future of Nuclear Power* was published. The thesis was that nuclear energy is an important option for the marketplace in a low-carbon world. At least for the next few decades, there are only four realistic options for reducing carbon dioxide emissions from electricity generation: increased efficiency in energy utilization, expanded use of renewables such as wind and solar, reducing carbon dioxide emissions at fossil-fueled power plants by switching from coal to natural gas or by transitioning to capture and permanent sequestration of the carbon dioxide, and nuclear power. The study perspective was that all options would be needed and it would be a mistake to exclude any of these four options from an overall carbon emissions management strategy. The report examined the barriers to nuclear power and made a series of recommendations to enable nuclear power as a market place option.

Since that report, there have been major changes in the U.S. and the world, as described in our 2009 *Update of the 2003 Future of Nuclear Power Report*. Concerns about climate change have dramatically increased, many countries have adopted restrictions on greenhouse gas emissions, and the U.S. is also expected to adopt limits on carbon dioxide releases to the atmosphere sometime in the future. Because nuclear energy provides about 70% of the “zero”-carbon electricity in the U.S. today, it is a major candidate for reducing greenhouse gas emissions from the electric sector. Projections for nuclear power growth in the United States and worldwide have increased dramatically, even if recently tempered by the world-wide recession. In the United States this has resulted in various announcements of intent to build new reactors, 27 submittals of license applications, 8 applications for Federal loan guarantees, and

some site preparation. However, no license for new construction has been issued in the U.S. as of mid 2010. Elsewhere in the world the construction of new plants has accelerated, particularly in China and India. In addition, South Korea joined the traditional global suppliers of nuclear plants by signing an agreement to build four reactors in the United Arab Emirates.

There have also been major developments in the nuclear fuel cycle. In the U.S., fuel cycle policies have been in a state of confusion. The Bush Administration initiated programs with the goal of commercially recycling fissile material from spent nuclear fuel (SNF) into new fuel assemblies, but failed to attract support in Congress. The U.S. Department of Energy spent many years in assessing, and submitted a license application for, a geological repository for SNF and high-level waste at Yucca Mountain (YM). However, the Obama Administration has now requested withdrawal of the license application. Overseas, Japan has started operation of a commercial nuclear fuel reprocessing plant. Finland and Sweden, after gaining public acceptance, have sited geological repositories for the disposal of SNF.

Because of the significant changes in the landscape, we have undertaken this study on the *Future of the Nuclear Fuel Cycle* to bring a sharper focus on the key technical choices available for an expanded nuclear power program in the U.S. and the near-term policy implications of those choices.

We acknowledge generous financial support from the Electric Power Research Institute (EPRI) and from Idaho National Laboratory, the Nuclear Energy Institute, Areva, GE-Hitachi, Westinghouse, Energy Solutions, and NAC International.





# Executive Summary

## *Study Context*

In 2003 MIT published the interdisciplinary study *The Future of Nuclear Power*. The underlying motivation was that nuclear energy, which today provides about 70% of the “zero”-carbon electricity in the U.S., is an important option for the market place in a low-carbon world. Since that report, major changes in the U.S. and the world have taken place as described in our 2009 *Update of the 2003 Future of Nuclear Power Report*. Concerns about climate change have risen: many countries have adopted restrictions on greenhouse gas emissions to the atmosphere, and the U.S. is expected to adopt similar limits. Projections for nuclear-power growth worldwide have increased dramatically and construction of new plants has accelerated, particularly in China and India. This study on *The Future of the Nuclear Fuel Cycle* has been carried out because of the continuing importance of nuclear power as a low-carbon option that could be deployed at a scale that is material for mitigating climate change risk, namely, global deployment at the Terawatt scale by mid-century.

To enable an expansion of nuclear power, it must overcome critical challenges in cost, waste disposal, and proliferation concerns while maintaining its currently excellent safety and reliability record. In the relatively near term, important decisions may be taken with far reaching long-term implications about the evolution of the nuclear fuel cycle—what type of fuel is used, what types of reactors, what happens to irradiated fuel, and what method of disposal for long term nuclear wastes. This study aims to inform those decisions.

For decades, the discussion about future nuclear fuel cycles has been dominated by the expectation that a closed fuel cycle based on plutonium startup of fast reactors would eventually be deployed. However, this expectation is rooted in an out-of-date understanding about uranium scarcity. Our reexamination of fuel cycles suggests that there are many more viable fuel cycle options and that the optimum choice among them faces great uncertainty—some economic, such as the cost of advanced reactors, some technical such as implications for waste management, and some societal, such as the scale of nuclear power deployment and the management of nuclear proliferation risks. Greater clarity should emerge over the next few decades, assuming that the needed research is carried out for technological alternatives and that the global response to climate change risk mitigation comes together. A key message from our work is that we can and should preserve our options for fuel cycle choices by continuing with the open fuel cycle, implementing a system for managed LWR spent fuel storage, developing a geological repository, and researching technology alternatives appropriate to a range of nuclear energy futures.

## Study Findings and Recommendations

### ECONOMICS

*The viability of nuclear power as a significant energy option for the future depends critically on its economics. While the cost of operating nuclear plants is low, the capital cost of the plants themselves is high. This is currently amplified by the higher cost of financing construction due to the perceived financial risk of building new nuclear plants. For new base load power in the U.S., nuclear power plants are likely to have higher levelized electricity costs than new coal plants (without carbon dioxide capture and sequestration) or new natural gas plants. Eliminating this financial risk premium makes nuclear power levelized electricity cost competitive with that of coal, and it becomes lower than that of coal when a modest price on carbon dioxide emissions is imposed. This is also true for comparisons with natural gas at fuel prices characteristic of most of the past decade. Based on this analysis, we recommended in 2003 that financial incentives be provided for the first group of new nuclear plants that are built. The first mover incentives put in place in the U.S. since 2005 have been implemented very slowly.*

#### RECOMMENDATION

**Implementation of the first mover program of incentives should be accelerated for the purposes of demonstrating the costs of building new nuclear power plants in the U.S. under current conditions and, with good performance, eliminating the financial risk premium. This incentive program should not be extended beyond the first movers (first 7–10 plants) since we believe that nuclear energy should be able to compete on the open market as should other energy options.**

### FUEL CYCLE

*There is no shortage of uranium resources that might constrain future commitments to build new nuclear plants for much of this century at least.*

*The benefits to resource extension and to waste management of limited recycling in LWRs using mixed oxide fuel as is being done in some countries are minimal.*

*Scientifically sound methods exist to manage spent nuclear fuel.*

#### RECOMMENDATION

**For the next several decades, a once through fuel cycle using light water reactors (LWRs) is the preferred economic option for the U.S. and is likely to be the dominant feature of the nuclear energy system in the U.S. and elsewhere for much of this century. Improvements in light-water reactor designs to increase the efficiency of fuel resource utilization and reduce the cost of future reactor plants should be a principal research and development focus.**

## SPENT NUCLEAR FUEL MANAGEMENT

*Long term managed storage preserves future options for spent fuel utilization at little relative cost. Maintaining options is important because the resolution of major uncertainties over time (trajectory of U.S. nuclear power deployment, availability and cost of new reactor and fuel cycle technologies) will determine whether LWR spent nuclear fuel is to be considered a waste destined for direct geological disposal or a valuable fuel resource for a future closed fuel cycle.*

*Preservation of options for future fuel cycle choices has been undervalued in the debate about fuel cycle policy. Managed storage can be done safely at operating reactor sites, centralized storage facilities, or geological repositories designed for retrievability (an alternative form of centralized storage).*

### RECOMMENDATIONS

**Planning for long term managed storage of spent nuclear fuel—for about a century—should be an integral part of nuclear fuel cycle design. While managed storage is believed to be safe for these periods, an R&D program should be devoted to confirm and extend the safe storage and transport period.**

**The possibility of storage for a century, which is longer than the anticipated operating lifetimes of nuclear reactors, suggests that the U.S. should move toward centralized SNF storage sites—starting with SNF from decommissioned reactor sites and in support of a long-term SNF management strategy.**

This will have the additional benefits of resolving federal liability for its failure to start moving SNF from reactor sites starting in 1998.

## WASTE MANAGEMENT

*Permanent geological isolation will be required for at least some long-lived components of spent nuclear fuel, and so systematic development of a geological repository needs to be undertaken. The conclusion of the 2003 MIT report that the science underpinning long term geological isolation is sound remains valid.*

The siting of a geological repository for spent nuclear fuel and high-level waste has been a major challenge for the United States. The failures and successes of U.S. and European programs suggest that *a nuclear waste management organization should have the following characteristics: (1) authority for site selection in partnership with state and local governments, (2) management authority for nuclear waste disposal funds, (3) authority to negotiate with facility owners about SNF and waste removal, (4) engagement with policy makers and regulators on fuel cycle choices that affect the nature of radioactive waste streams, and (5) long-term continuity in management.* These characteristics are not recognizable in the U.S. program to date. A key element of successful waste management programs is consistency of science-based decisions.

RECOMMENDATION

**We recommend that a new quasi-government waste management organization be established to implement the nation's waste management program.**

Closed fuel cycle design has focused on what goes back to the reactor but not on how wastes are managed.

RECOMMENDATION

**We recommend (1) the integration of waste management with the design of the fuel cycle, and (2) a supporting R&D program in waste management to enable full coupling of fuel cycle and waste management decisions.**

A key finding is that the U.S. classifies many radioactive wastes by source rather than by hazard. This has already created gaps in disposal pathways for wastes and this problem will be exacerbated with alternative fuel cycles.

RECOMMENDATION

**We recommend that an integrated risk-informed waste management system be adopted that classifies all wastes according to their composition and defines disposal pathways according to risk.**

## **FUTURE NUCLEAR FUEL CYCLES**

*The choices of nuclear fuel cycle (open, closed, or partially closed through limited SNF recycle) depend upon (1) the technologies we develop and (2) societal weighting of goals (safety, economics, waste management, and nonproliferation). Once choices are made, they will have major and very long term impacts on nuclear power development. Today we do not have sufficient knowledge to make informed choices for the best cycles and associated technologies.*

Our analysis of alternative fuel cycles for nuclear power growth scenarios through 2100 yields several results of direct importance in fuel cycle choices:

- ❑ fuel cycle transitions take 50 to 100 years;
- ❑ there is little difference in the total transuranic inventories or uranium needs in this century
- ❑ for the standard plutonium-initiated closed fuel cycle, many LWRs are needed in this century for nuclear power growth scenarios.

*A key finding is that reactors with very high conversion ratios (fissile material produced divided by fissile material in the initial core) are not required for sustainable closed fuel cycles that enable full utilization of uranium and thorium resources. A conversion ratio near unity is acceptable and opens up alternative fuel cycle pathways such as:*

- ❑ *Very different reactor choices. such as hard-spectrum LWRs rather than traditional fast reactors for closed fuel cycles, with important policy implications and potentially lower costs.*
- ❑ *Startup of fast reactors with low-enriched uranium rather than high-enriched uranium or plutonium thereby eliminating the need for reprocessing LWR SNF for closed fuel cycle startup.*

There is adequate time before any choices for deployment need to be made to move away from the open fuel cycle. However, there are many viable technological choices that need to be examined, and the time needed to establish new commercial options in the nuclear power business is long. Consequently, the R&D needed should now be vigorously pursued to enable alternative fuel cycle options by mid-century.

#### RECOMMENDATION

**Integrated system studies and experiments on innovative reactor and fuel cycle options should be undertaken with vigor in the next several years to determine the viable technical options, define the timelines of when decisions need to be made, and select a limited set of options as the basis for the path forward.**

### **NONPROLIFERATION**

Proliferation at its center is an institutional challenge. The civilian nuclear power fuel cycle is one of several routes to nuclear weapons materials. Establishment of enrichment and/or reprocessing capabilities are proliferation concerns and are not economic choices for small reactor programs. However, guaranteed supplies of fuel are important to countries that embark on electricity production from nuclear energy. Waste management will be a significant challenge for many countries.

#### RECOMMENDATION

**The U.S. and other nuclear supplier group countries should actively pursue fuel leasing options for countries with small nuclear programs, providing financial incentives for forgoing enrichment, technology cooperation for advanced reactors, spent fuel take back within the supplier's domestic framework for managing spent fuel, and the option for a fixed term renewable commitment to fuel leasing (perhaps ten years).**

### **RESEARCH DEVELOPMENT AND DEMONSTRATION**

*Many decades are needed to research, develop, demonstrate, license, and deploy at scale any major new nuclear technology. A robust RD&D program, aligned with the possibility of substantial nuclear power growth, must be implemented if the U.S. is to have well-developed fuel cycle options in time to make wise strategic fuel cycle choices. The 2010 DOE roadmap is a significant improvement on previous agency plans*

#### RECOMMENDATIONS OF RD&D PRIORITIES

- ❑ *Enhanced LWR performance and fuels.*
- ❑ A much broader set of spent fuel storage and nuclear waste disposal options than has been pursued for decades.
- ❑ Modeling and simulation capability for developing technology options and for understanding tradeoffs among options.

- Innovative nuclear energy applications and concepts, including provision of process heat to industrial applications and development of modular reactors.
- Rebuilding the supporting R&D infrastructure, such as materials test facilities and other key facilities to enable innovative fuel cycle and reactor R&D.

We estimate that about \$1 B/year is appropriate for supporting the R&D and infrastructure programs. Additional funding will be needed for large-scale government-industry demonstration projects at the appropriate time.

# Postscript

The tragic 9.0-magnitude earthquake and resulting tsunami that struck Japan on March 11, 2011 occurred as this report was in the final stages of production. Consequently, the severe consequences at the Fukushima Dai-ichi nuclear complex have not been factored into the study. The analysis of fuel cycle options presented in the report stands, but national discussions about the future of nuclear power in the U.S. and in other countries will be re-opened to varying extents. The importance of preserving options, a major theme in our discussion of spent nuclear fuel management and fuel cycle choices, is highlighted by the uncertain path that lies ahead.

It will take some time to investigate and fully understand the progression of events at the Fukushima reactors and spent fuel pools and, for the Nuclear Regulatory Commission, to reexamine safety systems, operating procedures, regulatory oversight, emergency response plans, design basis threats, and spent fuel management protocols for operating U.S. reactors. Some of these issues were addressed in the aftermath of the TMI-2 accident and the September 11 World Trade Center attacks, resulting both in hardening of U.S. nuclear plants against a number of accident scenarios and in improved emergency response preparations. The outcomes of the various inquiries are unknown as this report goes to press. Nevertheless, some consequences seem probable in the U.S.:

- ❑ Costs are likely to go up for currently operating and future nuclear power plants. For example, requirements for on-site spent fuel management may increase and design basis threats may be elevated. While events beyond the design basis accidents are routinely considered in the U.S. licensing procedures, their importance may increase. As discussed in the report, new plant economics are already challenging. Furthermore, some erosion of the recent gains in public acceptance of expanded nuclear power can be anticipated.
- ❑ The relicensing of forty year old nuclear plants for another twenty years of operation will face additional scrutiny, with outcomes depending on the degree to which plants can meet new requirements. Indeed, some of the license extensions already granted for more than 60 of the 104 operating U.S. reactors could be revisited. This may not affect the anticipated sixty-year lifetime for new plants (which rely much more on passive safety systems). Our fuel cycle analyses incorporated such sixty-year operating lifetimes for current and future nuclear power plants.
- ❑ The entire spent fuel management system – on-site storage, consolidated long-term storage, geological disposal – is likely to be reevaluated in a new light because of the Fukushima storage pool experience. Our view that SNF storage has been something of an afterthought in U.S. fuel cycle policy has been brought into sharper relief, and there could be a renewed impetus to move SNF away from reactor sites to consolidated storage and disposal.



- In line with many of our R&D recommendations, significant shifts in R&D plans could occur, with increased emphasis on: enhanced performance and life extension for existing LWRs; new materials for improved safety margins; dry cask storage life-extension; advanced technology for prevention or mitigation of severe accidents; and improved simulation of plant behavior under multiple unusual events.

How these and other post-Fukushima issues are resolved will have major implications for the future of nuclear power and for the optimum fuel cycle choices needed to support that future. We hope that this report will provide constructive input to the public and private decision-making processes over the next several years.

April 2011

# Chapter 1 — The Future of the Nuclear Fuel Cycle — Overview, Conclusions, and Recommendations

In 2003 MIT issued the report *The Future of Nuclear Power*. The focus for that report was the role of nuclear power as an important option to avoid greenhouse gas emissions. A major conclusion of the report was that “In deregulated markets, nuclear power is not now cost competitive with coal and natural gas. However, plausible reductions by industry in capital cost, operation and maintenance costs, and construction time could reduce the gap. Carbon emission credits, if enacted by government, can give nuclear power a cost advantage.” The primary recommendation was that the U.S. Government should provide assistance for the construction of the first few new nuclear plants. The recommendation was based on the need to operate within an untested regulatory regime, the failure of government to initiate spent nuclear fuel removal from reactor sites, and the public interest in understanding the economics of new nuclear power plants in the U.S. as part of a climate change risk mitigation strategy. There would be an opportunity to reduce or eliminate a substantial financing risk premium if the capability to build plants on schedule and within budget was demonstrated.

Since 2003 the urgency to address climate change has increased. The U.S. Congress has indeed adopted a set of incentives to aid the construction of the “first mover” nuclear plants and the Administration has proposed to expand the incentives. There has been a worldwide increase in projected growth of nuclear power and a large growth in the start of construction of new nuclear power plants in a few countries such as China. We undertook this study on the Future of the Nuclear Fuel Cycle to address two overarching questions in the context of the potential for significant growth in nuclear energy.

- ❑ What are the long-term desirable fuel cycle options?
- ❑ What are the implications for near-term policy choices?

Our analysis has led to three broad conclusions, the basis for which will be presented in this chapter and in the body of the report.

## CONCLUSION

**For the next several decades, light water reactors using the once-through fuel cycle are the preferred option for the U.S.**

The “once through” or open fuel cycle with light water reactors and the need to manage spent nuclear fuel are likely to be the dominant feature of the nuclear energy system in the U.S. and elsewhere for a good part of this century. It is today the economically preferred option, there is no shortage of uranium resources that might constrain future commitments to build new nuclear plants for at least much of this century, and scientifically sound methods exist to manage spent nuclear fuel.

#### CONCLUSION

### **Planning for long term interim storage of spent nuclear fuel – for about a century – should be an integral part of fuel cycle design.**

This will bring benefits for waste management and provide flexibility for future fuel cycle decisions. Those decisions will be influenced strongly by the scale and pace of future nuclear power development

#### CONCLUSION

### **For the longer term, there are multiple viable fuel cycle options with different economic, waste management, environmental, resource utilization, safety and security, and non-proliferation benefits and challenges. A significant research agenda is needed to explore, develop and demonstrate the advanced technologies to the point of allowing informed future market place and policy choices.**

Historically it has been assumed that the pathway to a closed fuel cycle included recovery of plutonium from light water reactor spent nuclear fuel and use of that plutonium to start sodium-cooled fast reactors with high conversion ratios. The conversion ratio is the rate of production of fissile fuel from abundant fertile materials in a reactor divided by the rate of consumption of fissile fuel. Conversion ratios greater than one imply more fissile nuclear fuel is produced than consumed. This future was based on two assumptions: (1) uranium resources are extremely limited and (2) a high conversion ratio is required to meet future needs. *Our assessment is that both assumptions are false.*

- ▣ *Our analysis leads to the conclusion that a conversion ratio of one is a viable option for a long-term closed sustainable fuel cycle and has many advantages: (1) it enables use of all fissile and fertile resources, (2) it minimizes fissile fuel flows — including reprocessing plants throughput, (3) there are multiple reactor options rather than a single fast-reactor option, and (4) there is a wider choice of nuclear reactor core designs with desirable features such as omitting blankets for extra plutonium production.*

Some of these reactor options may have significantly better economic, nonproliferation, environmental, safety and security, and waste management characteristics. There is time for RD&D to evaluate options before major investment decisions are required. A corollary is that:

- ▣ *We must use the available time effectively if real options are to materialize in a few decades. This conclusion has important ramifications. For example, a future closed fuel cycle could be based on advanced hard-spectrum LWRs rather than the traditional fast-spectrum reactors, possibly with rather different costs and fuel forms, or it could consign current LWR SNF to a geological repository rather than recycling. Such fundamentally different technology pathways underpin the importance attached to preservation of options over the next several decades.*

## ECONOMICS

### FINDING

Nuclear power can be economically competitive for baseload power under appropriate market conditions.

### RECOMMENDATION

**First mover incentives put in place in the U.S. since 2005 should be implemented rapidly.**

Our updated economic analysis (MIT 2009) is summarized in Table 1.1. While the U.S. nuclear industry has continued to demonstrate improved operating performance, *there remains significant uncertainty about the capital cost, and the cost of its financing*, which are the main components of the cost of electricity from new nuclear plants.

**Table 1.1 Costs of Electric Generation Alternatives**

	LEVELIZED COST OF ELECTRICITY				
	OVERNIGHT COST	FUEL COST	BASE CASE	W/ CARBON CHARGE \$25/TCO <sub>2</sub>	W/ SAME COST OF CAPITAL
\$2007	\$/KW	\$/MBTU	¢/KWH	¢/KWH	¢/KWH
Nuclear	4,000	0.67	8.4		6.6
Coal	2,300	2.60	6.2	8.3	
Gas	850	4/7/10	4.2/6.5/8.7	5.1/7.4/9.6	

Nuclear electricity costs are driven by high up-front capital costs. In contrast, for natural gas the cost driver is the fuel cost. Natural gas prices are volatile relative to other fuels; thus, a range of gas prices are presented. Coal lies in-between. The track record for the construction costs of nuclear plants completed in the U.S. during the 1980s and early 1990s was poor. Actual costs were far higher than had been projected. Construction schedules experienced long delays, which, together with increases in interest rates at the time, resulted in high financing charges. Whether the lessons learned from the past can be factored into the construction of future plants has yet to be seen. These factors have a significant impact on the risk facing investors financing a new build. For this reason, the 2003 report and our 2009 analysis applied a higher weighted cost of capital to the construction of a new nuclear plant (10%) than to the construction of a new coal or new natural gas plant (7.8%). Lowering or eliminating this risk-premium makes a significant contribution to the competitiveness of nuclear electricity. These construction cost and schedule difficulties have occurred in some countries but not others.

*Nuclear power can be economically competitive under appropriate market conditions.*

With the financial risk premium and without a carbon emission charge, electricity from nuclear is more expensive than either coal (without sequestration) or natural gas (at 7\$/MBTU). If this risk premium can be eliminated, the nuclear levelized cost decreases from 8.4¢ /kWh to 6.6 ¢/kWh and becomes competitive with coal and natural gas, even in the absence of carbon emission charges. With carbon emission charges, nuclear becomes either competitive or lower cost than either coal or natural gas. The first few U.S. plants will be a critical test for all parties involved. The risk premium will be eliminated only by demonstrated construction cost and schedule performance. Based on this analysis, we recommended in 2003 that financial first mover incentives be provided for the first group of new nuclear plants that are built. The first mover incentives put in place in the U.S. since 2005

have been implemented slowly. This should be accelerated for the purposes of determining construction costs and schedules at multiple plants. *The incentives should not be extended beyond the first mover program (i.e. for 7–10 plants).*

## URANIUM RESOURCES

### FINDING

*Uranium resources will not be a constraint for a long time.*

*Uranium resources will not be a constraint for a long time.*

The cost of uranium today is 2 to 4% of the cost of electricity. Our analysis of uranium mining costs versus cumulative production in a world with ten times as many LWRs and each LWR operating for 100 years indicates a probable 50% increase in uranium costs. Such a modest increase in uranium costs would not significantly impact nuclear power economics. However, given the importance of uranium resources for both existing reactors and decisions about future nuclear fuel cycles, we recommend:

### RECOMMENDATION

**An international program should be established to enhance understanding and provide higher confidence in estimates of uranium costs versus cumulative uranium production.**

## LIGHT WATER REACTORS

### FINDING

LWRs will be the primary reactor choice for many decades and likely the dominant reactor for the remainder of this century.

*For the next several decades, a once-through fuel cycle using LWRs is the preferred option for the United States.*

The expanded deployment of LWRs should be an important option in any strategy to mitigate climate risk. LWRs are the commercially existing technology and the current lowest-cost nuclear electric production option. They can be operated safely and built in sufficient numbers to match any credible nuclear power growth scenario. The market entry of other reactor types will be slow in part because of time-consuming testing and licensing of new technologies.

Originally it was thought that the commercial lifetime of an LWR would be 40 years. Today more than half the LWRs have obtained, and most of the others are expected to obtain, license amendments to operate for 60 years. Many may operate for even longer time periods. Simultaneously, improvements in operations and technology have increased the output of these reactors. The U.S. has made and will likely make major additional investments in LWRs. Because of the extended lifetimes of these reactors, there is time for improvements in LWR economics, safety, nonproliferation characteristics, and fuel cycles—including possible closed fuel cycles with sustainable conversion ratios near unity. Many of the potential improvements involve advanced fuels and related technologies that would benefit both existing and future LWRs. To protect and enhance the investments already made in LWRs:

### RECOMMENDATION

**We recommend a long-term RD&D program to further improve LWR technology.**

## SPENT NUCLEAR FUEL MANAGEMENT

Historically the United States has not considered SNF storage as a major component of fuel cycle policy. However, repository programs worldwide have adopted a policy of storing SNF (or the HLW from reprocessing) for 40 to 60 years before disposal in a geological repository to reduce the radioactivity and decay heat. This reduces repository costs and performance uncertainties. Countries such as France with its partly closed fuel cycle and Sweden with its open fuel cycle built storage facilities several decades ago for this purpose. The failure to include long term storage as part of the spent fuel management has had major impacts on the design of the proposed Yucca Mountain Repository (YMR). Due to the heat load of SNF, the repository was required to be ventilated to remove decay heat while the SNF cooled. The YMR would have, after 30 years of filling, become functionally an underground storage facility with active ventilation for an additional 50 years prior to closure.

Fuel cycle transitions require a half century or more. It is likely to be several decades before the U.S. deploys alternative fuel cycles. Long term interim storage provides time to assure proper development of repositories and time to decide whether LWR SNF is a waste that ultimately requires disposal or whether it is a valuable resource. For multiple reasons, we recommend:

### RECOMMENDATION

**Planning for long term interim storage of spent nuclear fuel—on the scale of a century—should be an integral part of nuclear fuel cycle design.**

In recommending century-scale storage, we are not precluding earlier reprocessing or geological disposal of SNF or much longer term managed storage if the technology permits. These options are preserved. The key point is that fuel cycle decisions should be taken over the next decade or two in the context of a century time scale for managed storage.

### FINDING

Either distributed storage (at reactor), centralized long-term storage, or storage in a repository is technically sound.

The choice between these options will be decided by a variety of technical, economic, and political factors. The burden of SNF storage is small at an operating reactor site because SNF storage is required after discharge from the reactor and before shipment off site. However, this is not true for decommissioned sites where there are no longer the normal reactor operations associated with SNF handling, storage, and security; SNF storage limits reuse of these sites (which are often attractive for development because of access to water and transportation infrastructure) for other purposes; and the tax and employment benefits of the reactor no longer exist. *Spent nuclear fuel should be removed as soon as possible from decommissioned reactor sites to centralized storage facilities or operating reactor facilities.*

Today the total quantities at decommissioned sites are small—about equal to a year’s production of SNF in the U.S. Centralized interim storage on a large scale would have the benefit of satisfying federal obligations to remove spent nuclear fuel from reactor sites. Building upon our recommendation for long-term interim SNF storage:

*Planning for long-term managed storage of spent nuclear fuel — for about a century — should be an integral part of nuclear fuel cycle design and preserve options.*

#### RECOMMENDATION

**We recommend that the U.S. move toward centralized SNF storage sites—starting initially with SNF from decommissioned sites and in support of a long-term SNF management strategy. The Federal government should take ownership of the SNF under centralized storage.**

*Spent nuclear fuel should be removed from decommissioned sites.*

The costs of SNF storage are small because the total quantities of SNF (~2000 tons/year in the United States requiring a total of 5 acres/year if placed in dry-cask storage) are small. Licenses for dry-cask SNF storage have been granted for 60 years at some plants.

Managed storage is believed to be safe for a century. Nevertheless, degradation of the spent fuel and storage casks occurs over time due to its heat load, radioactivity and external environmental conditions. Spent fuel in interim storage will need to be shipped either to a reprocessing plant or a repository. The ability of transporting spent fuel after a century of storage will require an understanding of the condition of the spent fuel and storage canisters. At present, limited research and testing on degradation mechanisms of high burnup fuel has been performed and there has been a trend towards higher burnup fuels. High confidence in the integrity of SNF after a century of storage, adequate for transportation and possibly reprocessing, and the possibility for even longer storage times are important considerations for informed fuel cycle decisions. A strong technical basis is essential.

#### RECOMMENDATION

**An RD&D program should be devoted to confirm and extend the safe storage and transportation period.**

### **WASTE MANAGEMENT**

*Geological disposal is needed for any fuel cycle option.*

#### FINDING

All fuel cycle options create long-lived nuclear wastes that ultimately require geological isolation, and the MIT 2003 report found the science underpinning geologic isolation to be sound.

#### RECOMMENDATION

**Efforts at developing suitable geological repositories for SNF from LWRs and HLW from advanced fuel cycles should proceed expeditiously and are an important part of fuel cycle design.**

There have been many failures and some successes in the siting, development, licensing, and operation of geological repositories. There are today no operating repositories for disposal of SNF. However, the United States operates one geological repository—the Waste Isolation Pilot Plant (WIPP) for defense wastes with small concentrations of transuranic elements (plutonium, etc.). WIPP is in its tenth year of operation. Commercial and defense SNF and HLW were to be disposed of in the Yucca Mountain Repository, and thus are now left without a known destination. Sweden and Finland have sited geological repositories for SNF near existing reactor sites with public acceptance. Both countries are in the process

of licensing these facilities. Multiple geological repositories for the disposal of long-lived chemical wastes (primarily heavy metals such as lead) have been operating in Europe for decades.

Successful repository programs have several defining characteristics: the waste generators are engaged in the programs; there is long-term program and funding continuity; and the programs are characterized by transparency, major efforts at public outreach, and support by local communities. Furthermore, social science is used to understand what features consolidate public acceptance and the program builds this into the technical design basis for a repository. For example, French social assessments resulted in explicitly including long-term retrievability of wastes as a design requirement to provide public confidence. All successful programs had major voluntary siting components. In countries such as Sweden, this strategy resulted in several communities willing to host the repository. Last, the programs as a policy examined multiple sites and technologies to provide (1) alternative options if any one approach failed and (2) confidence to the program and the public that a reasonable set of options had been evaluated before major decisions were made. The Swedish program examined multiple sites and two technologies (geological disposal and boreholes). The French program includes three options (direct disposal, multi-century storage, and waste destruction by transmutation).

*Defining characteristics of successful repository programs are not recognizable in the U.S. program.*

*Ideally a nuclear waste management organization would have the following characteristics: (1) authority for site selection in partnership with governments and communities, (2) management authority for nuclear waste disposal funds, (3) authority to negotiate with facility owners about SNF and waste removal, (4) engagement with policy makers and regulators on fuel cycle choices that affect the nature of radioactive waste streams, and (5) long-term continuity in management. These characteristics are not recognizable in the U.S. program to date.*

#### RECOMMENDATION

**We recommend that a new quasi-government waste management organization be established to implement the nation's waste management program with such characteristics.**

Successful repository programs do not close out options until there is high confidence in the selected option. Different options have different institutional characteristics that provide policy makers with choices and increase the likelihood of success. Some options, such as borehole disposal, may provide alternative methods of geological isolation that can be implemented economically on a small scale with desirable nonproliferation characteristics—suitable for countries with small nuclear power programs. The U.S. program had been frozen with one option for decades.

#### RECOMMENDATION

**We recommend an R&D program to improve existing repository options and develop alternative options with different technical, economic, geological isolation, and institutional characteristics.**

How wastes are classified (high-level waste, transuranic, etc.) determines disposal requirements. The U.S. classifies many radioactive wastes based on the *source* (Atomic Energy Act of 1954 based on the technologies of 1954)—not the *hazard* of the waste. The U.S. has devel-



oped policies for specific wastes rather than a comprehensive waste strategy and thus by default has created orphan wastes from the open fuel cycle with no disposal route. For example, the licensing application for the Yucca Mountain Repository was for the disposal of SNF and HLW; but, there are small quantities of other highly radioactive orphan wastes that will likely require geological disposal. If the U.S. adopted a closed fuel cycle, additional types of orphan wastes would be generated where the waste classification and disposal requirements would be unknown. The current system would become unworkable. Accordingly:

#### RECOMMENDATION

**We recommend that an integrated risk-informed waste management system be adopted that classifies all wastes according to composition and defines disposal pathways according to risk.**

This will eliminate regulatory uncertainties with some existing wastes and establish the foundation for waste management decisions associated with alternative fuel cycles. The Nuclear Regulatory Commission should take the lead in developing the appropriate framework. Such a framework can build upon the experiences of other nations and the efforts of the International Atomic Energy Agency. Many countries that developed nuclear programs at later dates used our waste management experiences (with both its positive and negative elements) to develop improved regulatory frameworks.

*An integrated risk-informed waste management system should be adopted.*

The U.S. has not historically integrated waste management considerations into the fuel cycle decisions adequately. The high cost of the defense waste cleanup programs was partly a consequence of the failure to integrate defense fuel cycles with waste management considerations. The policy failure to include SNF storage drove some costly design decisions for the proposed Yucca Mountain repository.

*Closed fuel cycle design has focused on what goes back to the reactor but not on how wastes are managed.* A closed fuel cycle entails processing of SNF to produce (1) reactor fuel elements and (2) waste forms designed to meet storage, transport, and disposal requirements. Fuel cycle studies to improve waste management (such as by actinide burning) have only considered a limited set of reactor-based options—not the full set of fuel cycle and waste management options (better SNF disposal packages, alternative nuclear fuel designs, actinide burning, special waste forms for specific long-lived radionuclides, borehole disposal, etc). Historically it was assumed the U.S. would first close the fuel cycle by recycling the fuel and then build geological repositories for separated wastes; later, the U.S. adopted an open fuel cycle policy and pursued siting a repository for SNF. Since a repository is needed irrespective of the fuel cycle, the U.S. should pursue a repository irrespective of when decisions are made on fuel cycles. Because repositories can be designed to allow retrievable waste packages, they can be used for SNF storage while maintaining the option for future closed fuel cycles—a strategy that disposes of what are considered wastes today while maintaining the intergenerational benefits of maintaining options. If repositories are sited before adoption of closed fuel cycles, this would allow co-location of reprocessing and repository facilities; that, in turn, could improve economics while reducing risks (reduced transportation, simplified reprocessing plant, etc.), could improve repository performance by choosing waste forms optimized for the specific repository, and may assist repository siting by coupling future industrial facilities with the repository.

## RECOMMENDATION

**We recommend (1) the integration of waste management with the design of fuel cycles, and (2) a supporting R&D program in waste management to enable full coupling of fuel cycle and waste management decisions.**

## FUTURE NUCLEAR FUEL CYCLES

*The choice of nuclear fuel cycle (open, closed, or partially closed [limited SNF recycle]) depends upon (1) the features of proven technology options and (2) societal weighting of goals (economics, safety, waste management, and nonproliferation). That fuel cycle choice will lead to fundamentally different futures for nuclear power. We do not today have sufficient knowledge about future options and goals to make informed choices .*

To understand the implications of alternative fuel cycles for the United States, we created a dynamic model of the nuclear energy system through the year 2100. Dynamic modeling is a method to follow in time the consequences of deployment of alternative fuel cycles for different sets of assumptions. Such comprehensive mathematical models of fuel cycles have only been developed in the last few years. Several alternative futures were examined.

- *Nuclear growth scenarios.* Three nuclear growth scenarios were considered: 1% per year (low), 2.5% per year (medium), and 4% per year (high). Fuel cycle choices partly depend upon nuclear growth rates. At low growth rates continuation of today's open fuel cycle is the preferred choice. At high growth rates there are incentives for improved utilization of the energy potential of mined uranium and for reduction of the long-term burden of SNF, but technical constraints exist and incentives may change depending upon the available technology and economics.
- *Fuel cycles.* Three fuel cycles were modeled in detail: today's once-through fuel cycle with LWRs, a partly-closed LWR fuel cycle with recycle of plutonium from LWR SNF back into LWRs and direct disposal of the recycle SNF, and a closed fuel cycle with LWRs and fast reactors. In the closed fuel cycle, LWR SNF is reprocessed and the transuranic elements including plutonium are used to start up fast reactors. The SNF uranium and transuranics from discharged fuel of fast reactors are recycled back to the fast reactors.
- *Fast reactors.* Our analysis of closed fuel cycles included three classes of fast reactors with different goals. In the first scenario the goal was to destroy actinides; thus, the fast reactors had a conversion ratio of 0.75. In the second scenario the goal was a self-sustaining fuel cycle; thus, the fast reactors had a conversion ratio of 1.0. In the third scenario the goal was to rapidly expand the availability of fissile fuel for fast reactors; thus the fast reactors had a conversion ratio of 1.23 with the excess transuranics used to start added fast reactors.

Results from the models under the stated assumptions indicate that:

- The transition from a system dominated by one fuel cycle to another requires 50 to 100 years.
- For medium and high growth scenarios, there were relatively small differences in the total transuranic (plutonium, americium, etc.) inventories between different fuel cycles in this century.

*A reactor with a conversion ratio near unity may be the best option for a closed fuel cycle. It could be started with uranium rather than plutonium.*

## NUCLEAR FUEL CYCLES

The United States uses the once-through open fuel cycle to fuel light water reactors (LWRs). This fuel cycle is the simplest and the most economic fuel cycle today. There are six major steps (Top line of Fig. 1).

- *Uranium mining and milling.* Uranium is the starting fuel for all fuel cycles. Uranium mining and milling is similar to the mining and milling of copper, zinc, and other metals. Uranium is often found with copper, phosphates, and other minerals and thus a co-product of other mining operations. About 200 tons of natural uranium is mined to fuel a 1000-MW(e) light-water reactor for one year.
- *Uranium conversion and enrichment.* The uranium is chemically purified. Uranium contains two major isotopes: uranium-235 and uranium-238. Uranium-235 is the initial fissile fuel for nuclear reactors. Natural uranium contains 0.7% uranium-235. In the uranium enrichment process, natural uranium is separated into an enriched uranium product containing 3 to 5% uranium-235 and  $\geq 95\%$  uranium-238 that becomes LWR fuel and depleted uranium that contains  $\sim 0.3\%$  uranium-235 and  $\sim 99.7\%$  uranium-238. There will be 10 to 20 times as much depleted uranium as product.
- *Fuel fabrication.* The enriched uranium is converted into uranium dioxide and fabricated into nuclear fuel. An LWR requires  $\sim 20$  tons of fuel per year.
- *Light-water reactor.* All power reactors in the United States are LWRs. The initial fuel is uranium-235 that is fissioned to produce heat. The fuel also contains uranium-238, a fertile non-fuel material. In the nuclear reactor some of it is converted to plutonium-239—a fissile fuel that is also fissioned to produce heat. The heat is converted into electricity. With a fresh fuel assembly, all the energy is from fissioning of uranium-235. When the fuel is discharged from the reactor as SNF, about half the energy being generated is from the fissioning of plutonium-239 that was created in the reactor.

- *Storage of SNF.* A typical LWR fuel assembly remains in the reactor for three to four years. Upon discharge of the SNF, it contains  $\sim 0.8\%$  uranium-235,  $\sim 1\%$  plutonium,  $\sim 5\%$  fission products, and uranium-238. The SNF is stored for several decades to reduce radioactivity and radioactive decay heat before disposal.
- *Waste disposal.* After interim storage, the SNF is disposed of as a waste in a repository.

Nuclear fuel cycles are different from fossil fuel cycles because nuclear reactors burn only a fraction of the fuel before the fuel is discharged as SNF. Full burnup of the fuel before discharge is not possible.

- The reactor produces heat by fissioning uranium-235 or plutonium-239. The resultant fission product “ash” in high concentrations will shut down the reactor
- The materials of fuel element construction have a limited endurance in the reactor and limit fuel burnup.

Because reactors can not fully utilize the fissile and fertile materials in a fuel assembly, there are many possible fuel cycles.

- *LWR partly closed fuel cycle (Top two lines of Fig. 1).* The fissile material in LWR SNF can be recycled back into LWRs. The LWR SNF is reprocessed, the plutonium and uranium recovered, and the plutonium and some uranium are fabricated into fresh fuel, and the resultant transuranic fuel is sent to the LWR. Because of the low fissile content of the LWR SNF, recycle of the plutonium reduces uranium fuel demand by only 15% and recycle of the uranium reduces uranium fuel demand by only 10%. The high-level waste (HLW) from reprocessing is stored for several decades to reduce radioactivity and radioactive decay heat before disposal. LWR SNF recycle changes the plutonium isotopes such that the SNF can only be recycled one or two times. The recycle SNF must either wait to go to a repository or could fuel fast reactors. Several countries recycle LWR SNF.

*continued next page*

## NUCLEAR FUEL CYCLES (continued)

Figure 1 Alternative Fuel Cycle

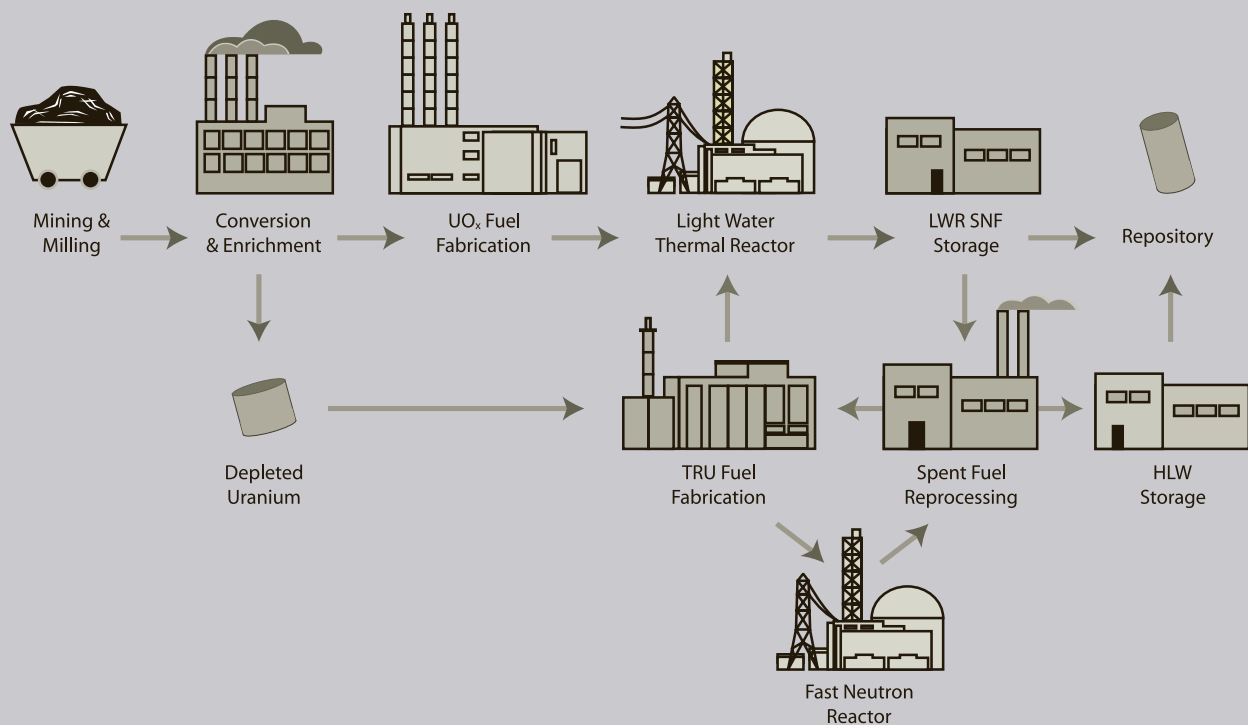

- Fast reactor fuel cycle.* Fast neutron-spectrum reactors can convert fertile uranium-238 to fissile plutonium-239 faster than they consume that fuel and thus convert all uranium-238 into fissile fuel over time. This enables full utilization of the depleted uranium from LWR uranium enrichment facilities, the uranium in LWR SNF, and the plutonium in LWR SNF. Such reactors can recover 50 times as much energy per kilogram of mined uranium as an LWR; however, fast reactor startup requires a large fissile inventory. The traditional strategy is to reprocess LWR SNF and use the recovered plutonium to fabricate fast reactor fuel. The plutonium in LWR SNF from 30 years of operations is required to start one fast reactor with a high conversion ratio. After fast-reactor startup and operation, fast reactor SNF is

reprocessed to recover plutonium and uranium. Plutonium and uranium from fast reactor SNF, and makeup depleted uranium are used to fabricate new fast reactor fuel assemblies. Each fast-reactor SNF assembly has sufficient plutonium for a new fast reactor fuel assembly. Fast reactors are under development in several countries but are today uneconomic and have not been deployed.

There are many other fuel cycles. A more complete description of fuel-cycle choices, criteria, and history is in Chapter 2.

- The primary differences were in the locations of those inventories. In a once-through fuel cycle the inventories were in repositories whereas in partly and fully closed fuel cycles the inventories were in reactors and SNF storage facilities.
  - For scenarios where the goal was burning of long-lived transuranics (conversion ratio of 0.75), only a small fraction of the transuranics will be burnt in this century.
- ▣ There are relatively small differences between fuel cycles in the total uranium mined within this century for any given nuclear power growth rate. Mined uranium savings would be 25% at most.
  - ▣ For medium and high growth scenarios, fast reactors started on plutonium fuel require construction of many LWRs and deployment of large capacity reprocessing and fuel fabrication facilities throughout the century in order to supply the initial cores.

#### FINDING

**A key finding of this analysis is that reactors with conversion ratios much higher than one are not materially advantageous for a sustainable fuel cycle—a conversion ratio near unity is acceptable and has multiple advantages. It enables options that may have significantly better economic, nonproliferation, and waste management characteristics than traditional advanced fuel cycles.**

Since the 1970s major decisions on development of sustainable closed fuel cycles have been based on the assumptions that uranium resources are limited and that consequently a reactor with as high a conversion ratio as feasible (which turns out to be 1.2 to 1.3) is required. These assumptions drove fuel cycle decisions. Our assessment is that both assumptions are incorrect—uranium resources are large and a conversion ratio of unity is preferred. This has multiple implications.

- ▣ *Efficient uranium utilization.* A conversion ratio of unity allows fast reactors to fully utilize all uranium and thorium<sup>1</sup> resources—including depleted uranium from uranium enrichment facilities and SNF.
- ▣ *Minimize the required throughput in the closed fuel cycle facilities.* A conversion ratio of unity implies that one fast reactor SNF assembly has sufficient fissile material when recycled to create one new fast reactor fuel assembly. This minimizes the quantities of fuel to be recycled and fabricated.
- ▣ *There are multiple reactor choices.* Sodium-cooled reactors have been the preferred choice for long-term sustainable reactors with closed fuel cycles because of their high conversion ratios, but this fuel cycle has not been commercially deployed. If the requirement is a conversion ratio of unity, other reactor options become feasible (Appendix B) including hard-spectrum (modified) light water reactors. With the wide industrial familiarity with water cooled reactors, economic advantages and acceptance by electricity producers are likely to be higher than alternatives.
- ▣ *Startup of fast reactors using low-enriched-uranium is viable.* A fast reactor with a high conversion ratio requires high concentrations of fissile fuel in the reactor core—plutonium or enriched uranium with uranium enrichment levels above 20% (weapons useable). A fast reactor with a conversion ratio near unity has lower total fissile fuel inventories and concentrations. It can be started on plutonium or low-enriched non-weapons-useable (enrichment levels below 20%) uranium. After start up, fast reactor SNF would be recycled to fast reactors to enable full utilization of uranium and thorium resources.

The startup of fast reactors with low-enriched uranium instead of plutonium has several advantages.

- *Economics.* Fast reactor enriched uranium reactor startup avoids the need to invest in LWR SNF reprocessing plants. Enriched uranium is likely to remain less expensive than plutonium from LWR SNF.
- *Uranium resource utilization.* With fast reactor startup on LWR plutonium, the rate of introduction is limited by plutonium availability. Low-enriched uranium startup avoids this limitation and enables earlier large-scale use of fast reactors with lower long-term uranium requirements.

- *It is unclear if LWR SNF will ultimately be a waste or a fuel resource.* The fissile content of the LWR SNF is low. Seven or eight LWR SNF assemblies must be recycled to create one new LWR fuel assembly. Fast reactors require greater fissile loadings, thus many more LWR SNF assemblies must be reprocessed to produce a fast reactor fuel assembly. In contrast one fast reactor fuel assembly can be made from one fast reactor SNF assembly. Given uranium resources, the option of starting fast reactors on enriched uranium, and recycle of fast reactor SNF, it may remain uneconomic to recycle LWR SNF.<sup>2</sup>

In this framework, we emphasize that a *once-through fuel cycle could, in the future, involve processing (i.e. partitioning) of SNF.* Particular radionuclides that pose waste management or non proliferation challenges could be separated for alternative disposal (Appendix B) — such as small packages for deep borehole disposal. Science-based risk-benefit analysis of the system would be required.

- *There are a wide range of fuel cycle choices.* If fissile resources are not a major constraint (uranium is available and a conversion ratio of unity is preferred) there is no requirement for very high recoveries of fissile materials from LWR SNF and there is a broader set of closed fuel cycles that may have better economic and nonproliferation characteristics. The concentrations of fissile materials in fuel can be lower and other impurities can remain with the fuel that may provide barriers to illicit use of SNF.

Our analysis leads to two conclusions.

*There is adequate time before any choices for deployment need to be made to move away from the current open fuel cycle.* Uranium resources are relatively abundant with respect to the uranium requirements for credible growth rates of the nuclear power system. Evolution from the open cycle will in any case be gradual.

*The preferred long-term path forward is not certain today.* For the long term, the incentives for development of alternative fuel cycles are: extension of fissile resources; possible mitigation of waste management challenges; and possible minimization of proliferation concerns. However, in the last decade there have been major changes in our understanding of uranium resources, implications of different fuel cycle assumptions such as the conversion ratio for advanced reactors, and new technologies. Multiple factors will influence the ultimate choice of a nuclear fuel cycle, including (1) the pace and scale of nuclear power deployment and (2) evolving technical, economic, and safety performance of fuel reprocessing methods, reactor types (both LWR and fast spectrum reactors), and disposal pathways for waste streams, and (3) the relative importance society places on different goals. Accordingly, we recommend that

*It is unclear if LWR SNF will ultimately be a waste or a fuel resource.*

#### RECOMMENDATION

**Integrated system studies and experiments on innovative reactor and fuel cycle options should be undertaken in the next several years to determine the viable technical options, define timelines of when decisions need to be made, and select a limited set of options as the basis for the path forward.**

For several decades little work has been done on new reactor and fuel cycle options (hard-spectrum light water reactors, once-through fast reactor fuel cycles, integrated reprocessing-repository systems, etc.) that have potentially attractive characteristics. Too much has changed to assume that the traditional fuel cycle futures chosen in the 1970s based on what was known at that time are appropriate for today. There is a window of time, if used wisely with a focused effort, to develop better fuel cycle options before major decisions to deploy advanced fuel cycles are made.<sup>3</sup>

In the context of fuel cycle choices, some have invoked intergenerational equity—usually in considering long-term hazards from radioactive waste and the impact on future generations—as a basis for decisions. The intergenerational benefits of closing the fuel cycle are largely based on extending the availability of nuclear fuel for future generations, but these must be balanced against the risks to present generations of undertaking spent fuel reprocessing and its associated activities. Net risks and benefits are partly dependent upon the available technologies, pointing to an intergenerational benefit of preserving options.

#### **NONPROLIFERATION**

Nuclear weapons proliferation is a national security challenge and requires diplomatic and institutional solutions. As nations advance technologically, it becomes increasingly difficult to deny them the technology and materials to develop nuclear weapons if they are motivated by security interests to do so. Thus proliferation at its center is an institutional challenge. The civilian nuclear power fuel cycle is one of several routes to nuclear weapons materials; therefore, strong incentives exist to adopt fuel cycle strategies that minimize the potential coupling of nuclear weapons and commercial nuclear fuel cycles. Hence, avoiding the creation of separated plutonium in future cycles would be an example of minimizing the potential coupling.

*Nuclear weapons proliferation requires diplomatic and institutional solutions.*

In the context of civilian fuel cycles and nonproliferation, the reactor is not the principal concern. The primary concerns are associated with uranium enrichment and/or reprocessing facilities—the front and backend fuel cycle facilities that would enable a nation to acquire weapon usable materials in a breakout scenario. Establishment of enrichment and/or reprocessing capability are not economic choices for small reactor programs; however, guaranteed supplies of fuel are important to countries that embark on electricity production from nuclear energy. Waste management will be a significant challenge for some countries.

#### RECOMMENDATION

**The U.S. and other nuclear supplier group countries should actively pursue fuel leasing options for countries with small nuclear programs, providing financial incentives for forgoing enrichment, technology cooperation for advanced reactors, spent fuel take back within the supplier's domestic framework for managing spent fuel, and the option for a fixed term renewable commitment to fuel leasing (perhaps ten years).**

As analyzed in the 2003 report, 80% of all SNF will likely be generated by the major nuclear states, at least until mid century; thus, if these countries chose to ultimately manage the world's SNF, there would be a small addition to their existing programs. *The failure to develop a broadly-accepted domestic SNF storage and disposal strategy limits U.S. nonproliferation policy choices in the context of nuclear fuel cycles; thus, nonproliferation objectives are served by effective waste management strategies.*

There is the possibility that advanced technologies could significantly decrease the attractiveness of SNF and other waste forms in the context of nonproliferation.<sup>4</sup> We recommend that

#### RECOMMENDATIONS

**Research on advanced technology options that decrease the attractiveness of nuclear materials for weapons should, as a supplement to institutional approaches, be included as part of reactor and waste isolation R&D programs.**

**There should be an RD&D program to strengthen the technical components of the safeguards regime.**

New technologies can significantly improve safeguards—including timely warning of diversion. While nonproliferation is fundamentally an institutional challenge, improved technology can assist the safeguards regime and raise the bar for diversion of fissile materials.

### **RESEARCH DEVELOPMENT AND DEMONSTRATION RECOMMENDATIONS**

#### FINDING

A robust RD&D program, aligned with the possibility of substantial nuclear power growth, must be implemented if the U.S. is to have well-developed fuel cycle options in time to make wise strategic fuel cycle choices.

#### RECOMMENDATION

**We therefore recommend RD&D for enhanced LWR capability should be increased significantly. RD&D for a broader set of spent fuel storage and nuclear waste disposal options should be pursued. Modeling and simulation is a core capability for developing technology options and for understanding tradeoffs among options. Research and development on innovative nuclear energy applications and concepts should play a more central role in the overall program.**

A robust RD&D program consists of three components: research and development, supporting research and testing infrastructure, and demonstration projects. There is a need to expand the scope of the R&D programs, to invest in enhancing the supporting infrastructure and to conduct tests on highly promising technology choices, often based on scientific simulations of possible alternatives.

*About \$1B/year is appropriate for nuclear R&D and research infrastructure programs.*

The R&D program recommended here would consist of seven core elements and will require an investment of about \$670 million per year. A rough breakout is suggested in Table 1.2.



**Table 1.2 Summary of R&D Recommendations**

ITEM	\$ 10 <sup>6</sup> PER YEAR	EXPLANATION
Uranium Resources	20	Understand cost versus cumulative world production
LWR Nuclear Power Reactor Enhanced Performance	150	Enhanced performance and life extension for existing LWRs New build LWR technology (New materials, fuel clad, etc.) Advanced fuel development through lead test assemblies
SNF/HLW Management	100	Dry cask storage life-extension Deep borehole and other disposal concepts Enhanced waste forms/engineered barriers
Fast reactors and closed fuel cycles	150	Advanced fast reactor concept analysis and experiments, simulation, basic science, engineering, and cost reduction New separations and analysis Safety and operations analysis
Modeling and Simulation	50	Advanced nuclear simulation innovation; Advanced materials for nuclear applications
Novel Applications and Innovative Concepts	150	High-temperature reactors; Modular reactors; Hybrid energy systems (nuclear-renewable-fossil options for liquid fuels, industrial heat). Peer-reviewed, competitive program for novel concepts.
Nuclear Security	50	Advanced safeguards Nuclear materials containment, surveillance, security, and tracking technologies

There is also the need to rebuild much of the supporting R&D infrastructure. To support R&D for new reactors and fuel cycles, facilities will ultimately be required with special test capabilities. Examples include fast neutron flux materials test facilities, fuel-cycle separations test facilities, and facilities for novel nuclear applications (hydrogen production, heat transport to industrial facilities, etc.). Some of these facilities are billion-dollar facilities—separate from the R&D expenditures listed above. A structural investment on the order of \$300 million per year will be required for a decade or so to make a significant difference.

There are large incentives for cooperative international programs where different nations build different facilities with agreements for long-term sharing. Unlike in the past, most new nuclear reactors and most fuel cycle research will be done elsewhere (France, Japan, Russia, China, and India)—there are both financial and policy incentives for cooperative programs.

Lastly, to support commercial viability of new types of advanced reactors and associated fuel cycles, demonstration projects are ultimately required. Such demonstration projects should be joint government-industrial programs and may involve investments of several billion dollars. This is the most difficult step in the development and deployment of new technologies where the U.S. has traditionally had great difficulties. There will be relatively few demonstration projects. International collaboration should be considered for such projects to expand the set of options that can be investigated.

The highest priority choices will emerge in time given the R&D program outlined above. These choices should be made with a view toward supporting licenseability of economically viable new technologies.<sup>5</sup> The cost of licensing of our new technologies has become a serious barrier — particularly to adoption of small-scale reactor designs.

## RECOMMENDATION

**The federal government should explore ways to reduce the time and cost of licensing new technologies using a risk-based technologically-neutral licensing framework.**

## **CITATIONS AND NOTES**

1. Our analysis of thorium versus uranium fuel cycles (Appendix A) found advantages and disadvantages for both fuel cycles—but the differences were not sufficient to fundamentally alter conclusions.
2. In a fuel cycle driven by economics, reprocessing is like uranium mining—the higher the “ore assay” the better the economics. We only mine higher-assay uranium ores. Similarly, we may in the future only recycle higher-fissile-assay SNF.
3. We do not have a good understanding of future nuclear power growth; consequently, we do not know when major fuel cycle deployment decisions will be made. The historical vision of the fuel cycle, recycle LWR SNF and transition to a sodium-cooled fast reactor system with plutonium from LWR SNF, is being developed by multiple countries. It becomes the path forward by default if options are not examined. Because of the potential for fuel cycles with substantially better characteristics—the nation has large incentives to evaluate and develop options to make choices rather than default decisions.
4. Analysis of existing fuel types (Appendix C) shows significant differences in the proliferation resistance of different types of SNF. The question is whether reactors with such fuel types can be economic.
5. Safety regulations for nuclear power plants have been designed for LWRs. The regulations for LWR safety are not appropriate for other reactor technologies. The U.S. Nuclear Regulatory Commission is moving toward “technology-neutral” licensing where new technologies must meet the same safety goals but can use different approaches to meet those goals. However, cost and time to license any new technology is a major barrier to innovation and better systems—including nuclear systems with better safety, waste management, and nonproliferation characteristics. Federal funding in demonstration projects reduces the barriers for technologies with large social benefits but small economic benefits to the companies commercializing such technologies.



# Chapter 2 – Framing Fuel Cycle Questions

The potential growth in nuclear power has resulted in a renewed interest in alternative nuclear fuel cycles. This leads to three questions. What are the criteria for selection of a fuel cycle? What are the choices? What are the constraints?

## FUEL CYCLE CONSIDERATIONS

Central to the choice of fuel cycle is the question of what considerations or criteria should be used as a basis to make long-term fuel cycle decisions. We developed a list of criteria (Table 2.1) that were used to aid our thinking about fuel cycles. These include technical and institutional components. The criteria of importance from a business perspective (economics, safety, environment) are different from the criteria of importance from a national or governmental perspective (waste management, long-term resource utilization and energy independence, and nonproliferation). Many of the difficulties and controversies associated with choosing a fuel cycle follow from the relative importance of different criteria to different groups.

<b>CRITERIA</b>	<b>TECHNICAL (Examples)</b>	<b>INSTITUTIONAL (Examples)</b>
Economics	Overnight capital costs	Financing, regulation
Safety	Risk assessment	Regulatory structure
Waste Management	Waste form, time of storage	Regulation, Societal views of intergenerational risk
Environment	Water consumption, land consumption	Water regulation, Greenhouse gas regulation
Resource utilization	Uranium resources and costs	Security of supply (uranium resource distribution by nation)
Nonproliferation	Separated plutonium, safeguards	Institutional arrangements for fuel materials.

The criteria were chosen based on the characteristics of nuclear fuel cycles. To understand the criteria some understanding is required of fuel cycles. The sidebar describes the once-through (open) fuel cycle—the fuel cycle that is most economic today and used in the United States for all power reactors.

If nuclear power growth is limited, there are limited incentives to change from the once-through fuel cycle. It would take decades to transition to another fuel cycle and require major investments. However if there is major growth, then alternative fuel cycles may become attractive and decisions must be made about the choice of fuel cycle and the criteria used

## The Once-Through Fuel Cycle for Light-Water Reactors

Most of the world's reactors are light water reactors that use a once-through open fuel cycle. This fuel cycle consists of seven steps.

- **Uranium mining and milling.** Uranium is the starting fuel for all fuel cycles. Uranium mining and milling is similar to the mining and milling of copper, zinc, and other metals. Uranium is often found with copper, phosphates, and other minerals; thus, it is often a co-product of other mining operations. About 200 tons of natural uranium is mined to fuel a 1000-MW(e) light-water reactor for one year.
- **Uranium conversion.** The uranium is chemically purified and converted into the chemical form of uranium hexafluoride ( $UF_6$ )
- **Uranium enrichment.** Uranium contains two major isotopes: uranium-235 and uranium-238. Uranium-235 is the initial fissile fuel for nuclear reactors. Natural uranium contains only 0.7% uranium-235. In the uranium enrichment process, natural uranium is converted into an enriched uranium product stream containing 3 to 5% uranium-235 and depleted uranium that contains ~0.3% uranium-235.
- **Fuel fabrication.** The enriched uranium is converted into the chemical form of uranium dioxide and fabricated into nuclear fuel. A typical LWR requires ~20 tons of enriched uranium fuel per year.
- **Light-water reactor.** When fresh fuel with uranium-235 is loaded into a reactor, the fissioning of uranium-235 produces heat. The fuel also contains uranium-238, which upon absorption of neutrons produces plutonium-239, a readily fissionable material like uranium-235 that also fissions to produce heat. Just before the fuel is discharged from the reactor as SNF, about half the energy being generated is from the fissioning of plutonium-239 that was created in the reactor. The heat is converted into electricity.
- **Interim storage of spent nuclear fuel (SNF).** A typical LWR fuel assembly remains in the reactor for three to four years. Upon discharge of the SNF, it contains ~0.8% uranium-235, ~1% plutonium, ~5% fission products, and the rest is mostly uranium-238. The SNF is stored for several decades to reduce radioactivity and radioactive decay heat before disposal.
- **Waste disposal.** If no advanced fuel cycle is deployed that can use plutonium and uranium-238, then the SNF would be considered a waste that ultimately must be sent to a geological repository for disposal.

Figure 2.1 Once-Through Fuel Cycle

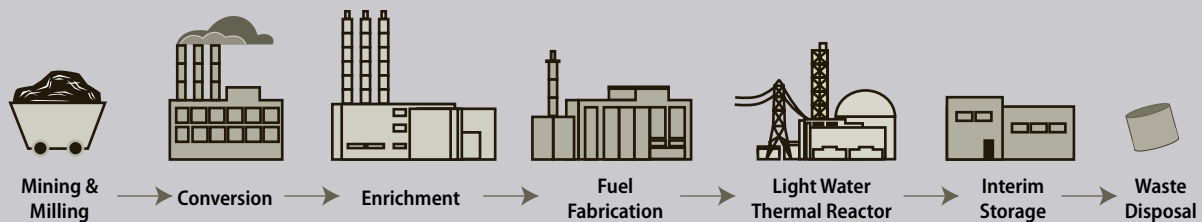

to judge fuel cycles. Some of the criteria (economics, safety, and environment) are similar to criteria used to evaluate any other energy system; but, the criteria of waste management, uranium utilization, and nonproliferation are unique to nuclear fuel cycles.

*Resource utilization.* The existing once-through fuel cycle uses less than 1% of the energy in the uranium that is mined. Other fuel cycles with other types of reactors can extract 50 times as much energy per ton of natural uranium. These reactors can use the depleted uranium byproduct of the enrichment process, the uranium in the SNF, and the plutonium in the SNF to produce energy. More efficient use of uranium would assure fuel for nuclear reactors for thousands of years. This is not done today in the United States because, among other reasons, it is uneconomic.

*Nonproliferation.* Fissile nuclear materials can be used to make nuclear weapons. Uranium enrichment plants can be used to make weapons-grade materials (>90% uranium-235). The SNF can be chemically processed to recover weapons-useable plutonium. The technical ease or difficulty of recovering weapons-usable materials is dependent upon the choice of fuel cycle, as the cycle affects the amount and concentration of the weapons-usable material in the fuel, and the associated intensity level of radioactivity, which makes handling the material more difficult. Ultimately though, nonproliferation is influenced more by the internationally applied policies as disincentives for nuclear weapons proliferation.

*Waste Management.* Spent nuclear fuel is the primary waste from the once-through fuel cycle. It contains greater than 99% of the radioactivity. It has unique characteristics compared to wastes from fossil plants. Only about 5% of the energy value has been consumed in the reactor. It can be considered either a waste or a future energy resource. The energy release from nuclear fission per ton of fuel is about a million times greater than the energy release from the burning of fossil fuels. The waste volume generated is about a million times less. The quantity of SNF is small per unit of energy produced. The small quantity (~20 tons per reactor per year) makes economically feasible multiple waste management options: multiple direct disposal options and multiple options to chemically process the SNF for recovery of selected materials for recycle and/or conversion into different waste forms.

*Economics.* Economics is the primary criterion by which a market-based system chooses reactors and fuel cycles. Table 2.2 shows the cost breakdown for new nuclear and fossil plants where costs are divided into capital costs, operating and maintenance costs, and fuel costs. There are also significant regional differences in relative costs of various energy sources. With today's once-through fuel cycle, fuel-cycle costs for an LWR are about 10% of the total busbar cost of electricity and include everything from the purchase of uranium ore to disposal of the SNF. The uranium costs (0.25 ¢/kwh) are approximately a third of the fuel costs or about 3% of elec-

**Table 2.2 Breakdown of the Levelized Cost of Electricity**

COSTS	NUCLEAR ¢/kwh (% OF TOTAL)		COAL ¢/kwh (% OF TOTAL)	NATURAL GAS <sup>2</sup> ¢/kwh (% OF TOTAL)
	RISK PREMIUM <sup>1</sup>	NO RISK PREMIUM <sup>1</sup>		
Capital Costs	6.6 (79)	4.9 (74)	2.8 (45)	1.0 (15)
Operations and Maintenance	0.9 (11)	0.9 (14)	0.8 (14)	0.2 (3)
Fuel costs	0.8 (10)	0.8 (12)	2.6 (41)	5.3 (82)
Total	8.4 (100)	6.6 (100)	6.2 (100)	6.5 (100)

1. In the U.S. there is a financial risk premium with new nuclear plants that increases capital costs. The federal first-mover incentives for new plants is to eliminate that financial risk premium.
2. Because of large variations in gas prices over the last decade, we assessed levelized cost of electricity for three gas prices: 4, 7, and 10 \$/10<sup>6</sup> BTU. The corresponding levelized costs of electricity were 4.2, 6.5, and 8.7 ¢/kwh.

tricity costs. Waste management costs are slightly over 10% of fuel cycle costs and thus between 1 and 2% of electricity costs. Several observations follow from such analysis.

- *Fuel cycle decisions that do not impact the choice of the reactor have small impacts on the cost of electricity.* If it is desired to recycle SNF into LWRs for any reason or use a somewhat more expensive disposal option for SNF, the relative cost impacts are small.
- *If one chooses an alternative fuel cycle that requires a different type of reactor, the capital cost of that reactor compared to an LWR will likely dominate the relative economics of the two options.*
- *High reactor capital costs favor fuel cycles that use reactors with the lowest capital costs.* Today LWRs have the lowest capital costs and the once-through fuel cycle is the economically preferred option. There have been proposals to develop LWRs with different types of reactor cores and fuel cycles—including hard-spectrum reactor cores and reactor cores to burn transuranics (plutonium, etc.). Presumably these modified LWRs would have capital costs similar to traditional LWRs. If an alternative fuel cycle is desired for any reason, economics will favor modifying the most economic existing reactor types to meet those goals if that is technically viable and meets all safety requirements.
- *If a new reactor type is demonstrated to be more economic than an LWR, it may drive many fuel cycle decisions.*

## FUEL CYCLE CHOICES

In the history of commercial nuclear power, three main fuel cycles have been developed: the open fuel cycle used today in the U.S., a partly closed fuel cycle used today in countries such as France, and a specific fast reactor fuel cycle that has been demonstrated but not deployed. These options are analyzed in this report to provide an understanding of fuel cycles in general.

The historical development of the commercial fuel cycle (Sidebar) was characterized by the commercial deployment of LWRs and the belief, based on the information then available, that uranium resources were extremely limited. Because of the relatively inefficient use of uranium by LWRs, uranium would become expensive and economically limit the use of nuclear energy. This led by the late 1960s to a single fuel cycle vision (Fig. 2.2) for the future.

- The first generation commercial reactors were to be light-water reactors (LWRs)—based partly on what had been learned from the navy nuclear propulsion program. Because LWRs extract less than 1% of the energy value of the uranium that is mined, they would be a transition technology to more uranium-efficient reactors.
- SNF from LWRs would be chemically processed (reprocessed) to recover uranium and plutonium for fabrication of sodium-cooled fast reactor (SFR) fuel to startup fast reactors. The fission product wastes from the LWR SNF would be converted into high-level wastes (HLWs) for disposal.
- The SFR would be developed and deployed. The fast reactor SNF would be reprocessed. The plutonium and uranium in the SNF would be combined with depleted uranium to produce new SFR fuel assemblies.

**Figure 2.2 Closed Fuel Cycle**

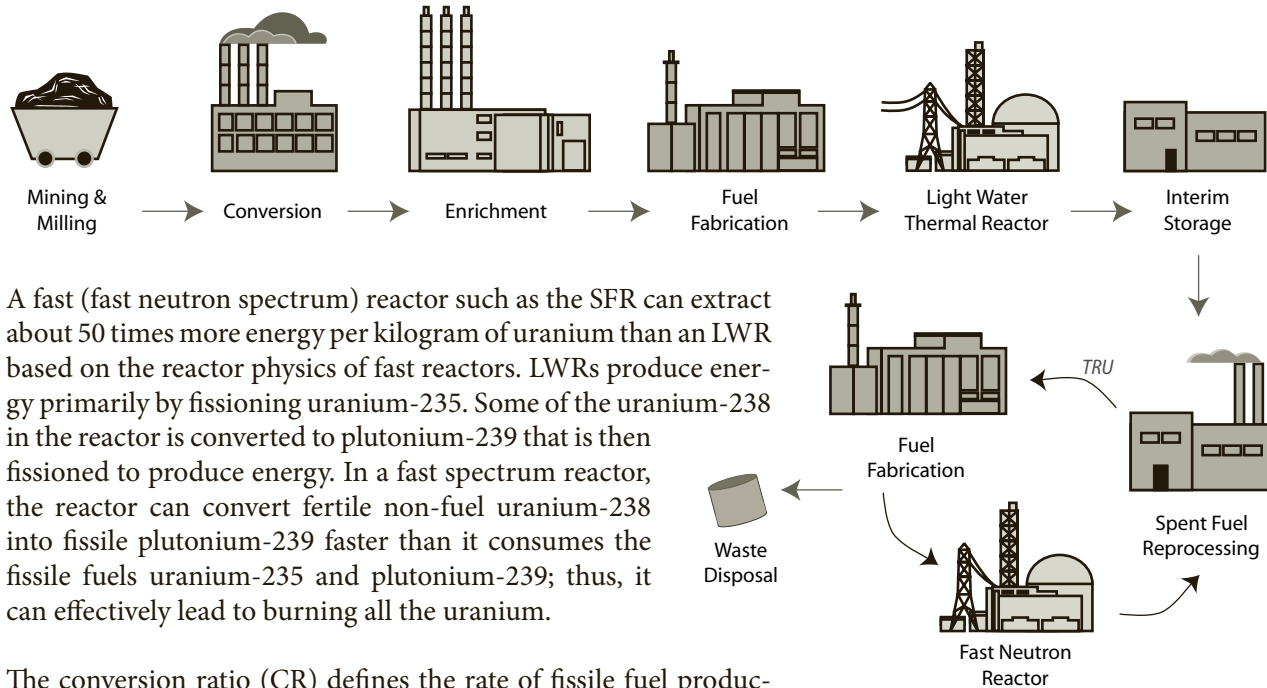

A fast (fast neutron spectrum) reactor such as the SFR can extract about 50 times more energy per kilogram of uranium than an LWR based on the reactor physics of fast reactors. LWRs produce energy primarily by fissioning uranium-235. Some of the uranium-238 in the reactor is converted to plutonium-239 that is then fissioned to produce energy. In a fast spectrum reactor, the reactor can convert fertile non-fuel uranium-238 into fissile plutonium-239 faster than it consumes the fissile fuels uranium-235 and plutonium-239; thus, it can effectively lead to burning all the uranium.

The conversion ratio (CR) defines the rate of fissile fuel production versus consumption in a reactor. A CR greater than one implies the reactor produces fissile material faster than it is consumed by converting fertile uranium-238 to plutonium-239. If a fast reactor has a conversion ratio of 1.2, one ton of fast reactor SNF has sufficient fissile material to produce 1.2 tons of fresh fast-reactor fuel. The SNF can be chemically processed to recover uranium and plutonium with the fission products becoming wastes. The plutonium and makeup uranium-238 would be combined to produce new fuel assemblies. The only makeup material is uranium-238. All of the depleted uranium from the uranium enrichment plants or the uranium in the LWR SNF could be used as make up for the uranium converted to plutonium.

With a CR of one or greater, a fast reactor is a sustainable large-scale energy source, in principle for tens of thousands of years. About 200 tons per year of uranium must be mined to operate a 1000 MW(e) LWR for a year whereas only 4 tons of uranium would be required for a fast reactor. In the 1960s and 1970s this vision led worldwide to large programs for development and commercialization of (1) reprocessing to recover uranium and plutonium from SNF and (2) sustainable fast reactors. The SFR was selected as the preferred fast reactor because it had the highest conversion ratio (1.3) of the feasible reactor options based on the technology of that time.

Sodium fast reactors with closed fuel cycles were not commercialized because experience with demonstration plants indicated that (1) SFR capital costs would be ~ 20% greater than LWRs, (2) the plants had higher maintenance costs than LWRs, and (3) uranium was found to be more abundant than initially thought. Over 70% of the cost of nuclear electricity is associated with the initial cost of the power plant while the cost of uranium for an LWR is only a few percent of the total cost of electricity.



**Figure 2.3 Partial Recycle of LWR SNF**

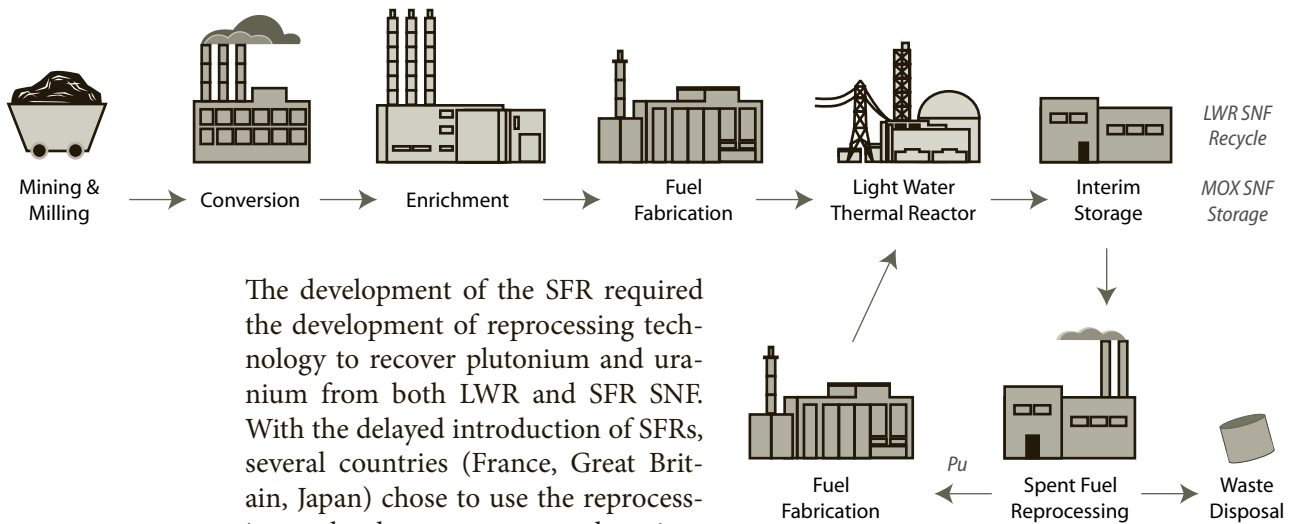

The development of the SFR required the development of reprocessing technology to recover plutonium and uranium from both LWR and SFR SNF. With the delayed introduction of SFRs, several countries (France, Great Britain, Japan) chose to use the reprocessing technology to recover plutonium from LWR SNF and recycle that plutonium back to LWRs as mixed oxide (MOX) fresh fuel that contained uranium and recycled plutonium (Fig. 2.3).

Because of the current limitations of LWR technology, it is difficult to recycle MOX SNF; thus, the plans are to store the MOX SNF and ultimately process the MOX SNF and recycle the fissile and fertile materials into future fast reactors. The partial recycle of LWR SNF back into LWRs increases the energy output per ton of mined natural uranium by about 25%, but is uneconomic and adds several percent to the overall cost of nuclear electricity.

Fuel cycle options are much broader than these choices.

- **Missions.** Fast reactors can operate with variable conversion ratios depending upon goals. If the  $CR < 1$ , plutonium and other actinides are destroyed. A  $CR = 1$  implies fissile material is produced from fertile at the same rate it is consumed. All uranium and thorium can be converted to fissile fuel. A  $CR > 1$  implies that fissile fuel is produced faster than it is consumed and thus enables the startup of added fast reactors over time.
- **Conversion ratio.** Historically it has been believed that a CR significantly greater than unity is desirable for advanced reactors because it results in the most rapid conversion of fertile materials to fissile materials. That belief led to the choice of the SFR—the only reactor that could be practically built with a conversion ratio greater than 1.2. Improved understanding of fuel cycles, as described in this report, indicate that CRs significantly greater than one places major constraints on fuel cycle choices but may not offer significant advantages over a reactor with a CR near unity. Lowering the CR to near unity creates a wider set of fuel cycle options with desirable features; however, today we do not know the preferred options among this set of options.
  - **Reactor choices.** Advances in technology have created multiple reactors (hard spectrum LWRs, some types of high-temperature reactors, etc.) that can have CRs of unity but can't be built with high CRs. Relaxing the requirements for the CR opens up the choice of reactor with potential economic and other advantages.

- *Fast reactor startup.* Traditional fast reactors require plutonium or medium-enriched uranium (weapons-useable) fuel for startup. Recent work at MIT indicates that fast reactors with CRs near unity can be started up on low-enriched uranium (<20%  $^{235}\text{U}$ —non weapons useable). This has potential economic and nonproliferation benefits applicable to all fast reactors.
- *Fast reactor fuel inventories.* High CRs require reactor cores with higher fissile inventories. This has an economic implication but also implies that fewer reactors can be started up on a given quantity of plutonium.
- *Fissile resources.* Reactors produce power by fissioning fissile fuel ( $^{233}\text{U}$ ,  $^{235}\text{U}$ , and  $^{239}\text{Pu}$ ). If economics determines the choice of fuel, the lowest cost source of fissile material will be used. Today that is  $^{235}\text{U}$  from mined uranium. In the future it may be plutonium from SNF; but, not all SNF is equal. Like in the mining of uranium, the higher the fissile content of the SNF, the lower the cost to recover the fissile material. There are many possible futures where some SNF is recycled and other SNF is waste.
  - *LWR SNF recycle.* Fresh LWR fuel contains ~5%  $^{235}\text{U}$  and ~95%  $^{238}\text{U}$ . Discharged LWR SNF contains 0.8%  $^{235}\text{U}$  and about 1% plutonium. The plutonium from ~7 tons of SNF is required to create one ton of new LWR fuel. The low fissile content of LWR SNF combined with the high costs of reprocessing make LWR SNF recycle into LWRs uneconomic today.
  - *Fast reactor SNF recycle.* In a sustainable fast reactor, the initial fuel has a fissile content between 15 to 30% with a similar range of fissile content for the SNF. One ton of fast reactor SNF yields more than one ton of new fast reactor fuel. In addition, the energy produced per ton of fast reactor fuel is about twice that in a LWR. Relative to an LWR, only 5 to 10% as much SNF must be processed in a fast reactor fuel cycle per unit of electricity produced. There are many scenarios where recycle of fast reactor SNF would be economic whereas recycle of LWR SNF would be uneconomic and LWR SNF becomes a waste.
- *SNF processing.* Historically it has been assumed that SNF would be processed to recover fissile materials for recycle into power reactors. However, SNF can be processed into other chemical forms for storage or disposal to meet alternative waste management or nonproliferation objectives.
- *Wildcard technologies.* There has been relatively little R&D on nuclear power options for several decades. In that time there have been major advances in technologies and new concepts for radically different reactors and fuel cycles. There has not been the analysis and associated experiments to sort through these advanced concepts to determine if any of these “wildcard” technologies is viable and would radically change future fuel cycle choices. We describe some of the potentially more attractive concepts (Appendix B) and some of the technological challenges associated with each.

## ANALYSIS OF FUEL CYCLES

Fuel cycles are complex. Two approaches were undertaken to understand fuel cycle options as a basis for recommendations. First, focused studies were undertaken to understand specific challenges associated with specific fuel cycle steps (uranium resources, spent nuclear fuel storage, and waste management). Second, new simulation tools were developed and used to enable dynamic modeling of alternative nuclear fuel cycles. Dynamic modeling

## History of the Nuclear Fuel Cycle

Before World War II (WWII) there was a small uranium mining industry where the primary product was radium—a decay product of uranium. Radium was used for luminescent watch and instrument dials. The first uranium mining boom was to supply radium watch and aircraft instrument dials in WWI. Small quantities of uranium were used as coloring agents in pottery glazes and a few other specialized applications.

In WWII the United States developed the atomic bomb—followed by the cold war with the building of large arsenals of nuclear weapons and nuclear propulsion systems for submarines and other naval vessels. This resulted in large increases in uranium demand. Because uranium was thought to be very scarce, uranium mining became a national priority. In parallel, new separations processes were developed and deployed to reprocess all SNF and recover the plutonium and uranium. High-level waste that contained uranium from earlier plutonium production programs was reprocessed a second time to recover uranium. Over 100,000 tons of uranium were recovered from defense SNF reprocessing and recycled back to uranium enrichment plants to produce recycled enriched uranium.<sup>1</sup>

Because it was generally accepted that uranium resources were limited and uranium would become increasingly expensive, the U.S. government supported the commercialization of SNF reprocessing with the start of the commercial nuclear power industry. With government support, a small privately-owned reprocessing plant was built and operated at West Valley, New York. General Electric (GE) built a small demonstration plant using a new process at Morris, Illinois; however, because of problems identified during cold testing it was never operated. The construction of a larger commercial plant was started at Barnwell, South Carolina and ESSO (now Exxon) was planning to enter the commercial reprocessing business. Except for the GE plant, all the reprocessing plants used the Purex technology developed for military needs that produced pure uranium and plutonium products.

1. The total commercial SNF inventory is slightly greater than 60,000 tons; thus, the defense programs processed more SNF than now exists. However, most of the defense SNF had much lower burnups and thus lower inventories of actinides and fission products.

With the detonation of the first Indian nuclear explosive in 1974, intense concerns about the spread of nuclear weapons developed within the U.S. foreign policy establishment, and that included concerns about reprocessing technology that could be used to separate plutonium from SNF for use in nuclear weapons. This led President Ford to announce “deferral” of commercial reprocessing in October 1976 which was extended indefinitely by President Carter in 1977. This decision was later reversed by President Reagan. The U.S. position was that by forgoing reprocessing it would be able to lead and prevent the rest of the world from building reprocessing plants. National nonproliferation concerns resulted in a change in nuclear fuel cycles.

At about the same time, the projected economics of recycling SNF versus a once-through fuel cycle changed. There were increasing uranium discoveries in different geological settings that indicated global uranium resources had been seriously underestimated. The costs of reprocessing were higher than originally estimated. Lower commercial nuclear power growth reduced projected future demands for uranium. The United States adopted the once-through nuclear fuel cycle where SNF is not recycled based on policy and economic considerations.

Most nations ultimately chose the once-through fuel cycle based on economics or policy. However, other nations choose to recycle SNF. France, Great Britain, and recently Japan built large commercial reprocessing plants. The cost of nuclear fuel is a small component of the total cost of nuclear electricity; consequently a nation can choose alternative fuel cycles today for a variety of policy reasons without large impacts on the cost of nuclear electricity.

In the last decade SNF recycle has been examined as a method to reduce waste management challenges and to aid siting of geological repositories—a third factor influencing the choice of fuel cycles.

Fuel cycle considerations drove reactor development programs. The first-generation commercial reactors were light-water reactors (LWRs)—an outgrowth of the development of LWRs for submarines, as well as a natural outcome of the century of experience in using water in fossil plants. However, LWRs do not efficiently use uranium resources and thus were initially thought to be a short-term transition tech-

### History of the Nuclear Fuel Cycle *(continued)*

nology to a more uranium-efficient nuclear reactor—the sustainable fast (breeder) reactor. Fast reactors can extract more than 50 times as much energy per kilogram of uranium than in today's LWR.

All nuclear fuel cycles start with natural uranium that contains 0.7% uranium-235 and 99.3% uranium-238. LWRs produce energy primarily by fissioning uranium-235 using thermal (low energy) neutrons. Some of the uranium-238 in the reactor is converted to plutonium-239 that is then fissioned to produce energy. In a fast reactor, the reactor can convert fertile uranium-238 into fissile plutonium-239 faster than it consumes the fissile fuels uranium-235 and plutonium-239; thus, it can effectively burn all the uranium.

The sodium fast reactor (SFR) was selected as the preferred future reactor type because it was most efficient at converting uranium-238 to fissile plutonium-239 of the technically feasible reactor options in the 1960s. For every ton of plutonium in fresh fuel, the SNF from the SFR could contain up to 1.3 tons of plutonium—enough to fuel the SFR and provide fuel to startup new reactors. The SFR has not been commercialized because its capital costs are greater than LWRs.

The savings in uranium costs are less than the added capital costs of an SFR.

Several countries (France, Germany, and Japan.) recover uranium and plutonium from LWR SNF and recycle the plutonium back to LWRs as fresh fuel. Because existing LWRs convert only a small fraction of the uranium-238 to plutonium, this form of recycling can only increase the energy output per ton of natural uranium by about 25%<sup>2</sup>. SNF is a potential energy resource—its energy value can be recovered in the future if there are policy or economic incentives to do so.

Analysis and experience shows that the transition times between fuel cycles are measured in many decades. Because policy and technology changes occur on a time scale shorter than the fuel-cycle transition times, we must think about fuel cycle policies in the context of a dynamic state—not an end point that may never be reached.

---

2. Recycle of plutonium from LWR SNF can increase electricity per unit of uranium mined by 15%. Recycle of the uranium in the LWR SNF can increase electricity per unit of uranium by 10%; however, very little uranium recycle has been done.

enables one to understand the transition dynamics from one fuel cycle to another fuel cycle and the implications of different assumptions such as the choice of CR. Using this tool a series of studies were undertaken to:

*Examine the implications of a reasonable range of nuclear energy growth rates on various fuel cycle options over this century, with a focus on the first 50 years. Derive from the analysis recommendations for implementation in the next decade*

The nuclear plant cost structure and technology favor very long plant lifetimes. Nuclear power plants were initially licensed for 40 years. The licenses of these reactors are being extended to 60 years and many people expect that the plant life will ultimately be 80 years. This implies that fuel cycles must be considered on a century time scale. The key questions were:

- How would various fuel cycle options impact demand for nuclear fuel (mined uranium or fissile fuel from recycle of LWR SNF)
- How are the amounts of SNF to be stored, transuranics (TRU, primarily plutonium) in the system, and geological repository capacity impacted by the choice of fuel cycle?

- What is the impact of timing of the introduction of partly or fully closed fuel cycles on the amounts of stored SNF, TRU, and wastes to be sent to repositories

For each fuel cycle scenario, three nuclear power growth rates were examined: 1, 2.5, and 4% per year. A 1% growth case matches the expected growth in electric demand by the U.S. Energy Information Agency from 2010 to 2035. In this scenario nuclear energy maintains its 20% share of electricity production. The higher growth rates imply an increasing fraction of total electricity produced by nuclear energy. For each growth rate three fuel cycles were considered:

- *Open fuel cycle.* This is the fuel cycle used today in the United States.
- *Partial recycle.* This is the recycle of LWR SNF by processing the SNF, recycling the plutonium into MOX fuel for LWRs, and irradiating it in LWRs. The MOX SNF is then stored. This is the fuel cycle currently used in France.
- *Closed fuel cycle.* LWR SNF is processed and the plutonium is used to produce fast reactor fuel for the startup of new fast reactors. Fast reactor SNF is recycled back to fast reactors. Three variants of the closed fuel cycle were modeled.
  - Conversion ratio of 0.75. The fast reactor is burning transuranics, including plutonium, faster than it is being produced. It is a scenario where the goal is to reduce transuranic inventories to meet some future nonproliferation goal or to reduce the long-lived transuranic isotopes that must ultimately be disposed of in a geological repository.
  - Conversion ratio of 1.0. The fast reactor makes plutonium as fast as it consumes plutonium.
  - Conversion ratio of 1.23. The fast reactor makes plutonium faster than it consumes it with the additional plutonium used to start additional fast reactors.

There are other fuel cycles. These fuel cycles were chosen as representative fuel cycles that capture the major characteristics of the different options. Thorium fuel cycles were not analyzed because they are not believed to fundamentally alter conclusions. A description and discussion of thorium fuel cycles is in Appendix A.

## FRAMING FUEL CYCLE ISSUES

### Uranium Resources

Uranium is the starting fuel for all fuel cycles. If uranium resources are very large, a resource requirement to recycle SNF and develop a reactor with more efficient uranium usage would not be required for a long time. Nuclear reactor and fuel cycle choices would not be economically constrained by uranium resources and the nuclear industry would be free to adopt a much wider set of fuel cycle and reactor options. We developed a model to estimate uranium costs versus cumulative uranium production (cumulative electricity production). The results of our assessment of uranium costs are in Chapter 3.

## Spent Nuclear Fuel

Reactors discharge SNF that contains fissile materials (fuel) and fission products (waste). The radioactivity and decay heat of SNF decreases rapidly with time; thus, to reduce handling risks and costs SNF is stored before transport, disposal, or recycle. Although there are strong technical and policy reasons for storing SNF for several decades, the U.S. has never developed a long-term SNF storage strategy. Chapter 4 addresses options for SNF management.

## Waste Management

All fuel cycles generate some types of long-lived radioactive wastes; thus the ultimate need for disposal of those wastes. The disposal of SNF and HLW has been a major (and so far unsuccessful) technical and institutional challenge for the U.S. However, the U.S. successfully sited and has operated for a decade the Waste Isolation Pilot Plant—a geological repository for the disposal of defense transuranic (plutonium) wastes. Several European countries operate geological repositories for disposal of long-lived chemical wastes and have sited and are now licensing SNF/HLW repositories. This has been done with local and national public acceptance of the sites. The question therefore is what can be learned from both successes and failures for future successful siting of a SNF/HLW geological repository. Chapter 5 discusses what has been learned and thus what is required for a successful repository program.

Fuel cycle decisions have been decoupled from waste management decisions. However, integration of fuel cycle and waste management opens up new choices. Historically it was assumed that a repository would be built after fuel cycle choices were made to accept whatever wastes were generated. There are other options. We could choose to build a repository for disposal of SNF today but designed to enable SNF recovery for many centuries—in effect a decision to minimize liabilities to future generations while maintaining options for future generations to use that SNF. Alternatively we could integrate and collocate future closed fuel cycle reprocessing, fabrication, and repository facilities into a single facility with potentially lower costs and risks that combined liabilities and benefits of closed fuel cycle facilities in the same communities and states. These and other choices are examined in Chapter 5 on waste management.

## Fuel Cycle Analysis

As discussed in Section 2.3, we developed a systems dynamics model of the fuel cycle to understand the long-term implications of different fuel cycle policies and technological choices. The results of analysis are described in Chapter 6.

## Fuel Cycle Economics

Two types of economic analysis were undertaken. First, an updated analysis of the economics of nuclear power today was undertaken as the basis to make recommendations to improve nuclear power economics. Second, a methodology was developed and used to understand the economics of alternative fuel cycles. In a fossil fuel cycle, the interconnection between different fossil plants is limited by the impacts on the price of fossil fuels. In

nuclear fuel cycles, the wastes (SNF) from one reactor may become the fuel for another type of reactor. This couples the economics of different fuel cycles. These results are discussed in Chapter 7.

### **Nonproliferation**

Global fuel cycle choices are key to proliferation risks associated with nuclear power. Specifically, limitation of the spread of enrichment and reprocessing facilities and technologies, especially in regions of geopolitical concern, is the objective. U.S. policy must be conditioned by several realities: the U.S. is no longer in the lead in developing, deploying, and exporting nuclear technology; lack of a domestic SNF storage and disposal program limits policy options; a new generation of safeguards technologies for detecting activities outside the boundaries established by the Nonproliferation Treaty is needed. Chapter 8 discusses the challenges and issues that couple nuclear fuel cycle development and nonproliferation strategies.

### **Research Development and Demonstration**

In the last 30 years, major investments have been made in learning how to reliably and safely operate nuclear power plants. Today nuclear plants typically operate 90% of the time. A few decades ago these plants operated 60% of the time and were often shut down for maintenance and refueling. In contrast, there have not been major investments in nuclear power RD&D. The general advances in technology and research in nuclear power have defined options that on paper look attractive relative to today's technologies. However, the investments to determine if these options are real have not been made. Better understanding of options is required to make informed fuel cycle decisions before large investments are made to commercialize these technologies. These potential options are discussed in the appropriate chapters and form the basis of the RD&D recommendations as summarized in Chapter 10.

### **Other Considerations**

To support our assessments, we undertook a series of supporting studies on thorium fuel cycles, advanced technologies that could change fuel cycle choices if successfully developed, high temperature reactors, intergenerational equity, and the current status of fuel cycle technology. The appendices summarize these assessments.

# Chapter 3 — Uranium Resources

Important decisions such as whether and when to reprocess and recycle, and/or to deploy breeder reactors, hinge in large part on the future cost of nuclear fuel for LWRs. While prediction is fraught with considerable uncertainty, most recent expert opinion concurs with the 2007 “Red Book” assessment that identified economically recoverable reserves sufficient for a century at current use rates [1]. In preparing the present assessment a number of other recent reviews also proved useful [2–8]. Building on these prior analyses, this chapter provides a framework for quantification of uranium cost projections applicable to nuclear power growth scenarios of interest. The results confirm that the once-through LWR fuel cycle can remain competitive past mid-century, even if the use of nuclear power is aggressively expanded. However, uranium price volatility is likely to continue until the present production/consumption imbalance is resolved.

The focus in what follows is on global uranium supply, rather than solely on domestic U.S. production. Uranium is an internationally traded commodity, with several reliable suppliers. Moreover, nuclear reactors are expensive machines burning cheap fuel, so that there has been a virtual absence of concern in the U.S. over “uranium energy independence.” Indeed, over the past decade, eighty percent of U.S. uranium has been imported, without controversy.

Although other front-end steps are required to produce usable fuel from mined uranium (conversion to  $UF_6$ , enrichment, and fabrication), these topics are not addressed, because all are services that are not resource-limited. They are, however, investment dependent, which means that the economic disruption which struck in full force in late 2008 could well delay and attenuate their buildup.

## **SOME PERSPECTIVE**

In the analysis that follows, a representative requirement of 200 metric tons (MT) of natural uranium per full-power gigawatt electric year (GWe-yr) is used. Actual annual values vary with the type of reactor (PWR/BWR/other, vendor, vintage of model), enrichment plant tails specification, operator fuel management tactics (fraction of core refueled each shutdown), plant capacity factor and thermodynamic efficiency achieved. As a consequence a  $\pm 25\%$  variation is common in the literature. Furthermore, after more than four decades of experience and evolution, LWR fuel design and fuel management practices have now matured to the point where large changes in future ore requirements per GWe-yr are not anticipated. Hence uranium demand is relatively simple to estimate given a postulated scenario for nuclear electricity production.



Because ore demand is closely coupled to nuclear generating capacity, its uncertainty is much smaller than that on the uranium supply side; thus only the latter is scrutinized in this chapter. The supply side is more problematical since the uranium market has been in a state of imbalance for over a decade, with primary production providing only 60% of consumption, the balance being met through drawdown of stockpiles, down-blending Russian and U.S. highly enriched uranium (HEU), and other sources. The latter program is scheduled to end in 2013. However, following the spike in the price of uranium in 2007, the past few years have seen a large increase in exploration and planning for expansion of production. This will bear full fruition only some 10 to 20 years in the future due in part to increased environmental/licensing requirements (and occasional local opposition), which suggests a like period of continuing price volatility. Figure 3.1 shows the historical record of price data for the spot market, which accounts for only about 10–15% of all transactions — the remainder being on long-term contracts, where confidentiality commonly prevails. Thus, the focus will be on forecasting long term **cost** of production rather than the (instantaneous) spot market **price**.

It is also important to keep in mind that in the recent past uranium has accounted for only about 4% of the lifetime-levelized busbar cost of new plant nuclear-generated electricity (hence ~2% of the retail, delivered cost). Thus significant increases could be tolerated without compromising the competitive status of nuclear energy.

The first, and last, major wide-scope coordinated worldwide assessments of existing and projected uranium ore resources were made over several years bracketing 1980. They consisted of the U.S. National Uranium Resource Evaluation (NURE), the International Uranium Resource Evaluation Program (IUREP), and the more wide ranging U.S. Nonproliferation Alternative Systems Assessment Program (NASAP) and the International Nuclear Fuel Cycle Evaluation (INFCE): Refs (9-12), respectively. Since then the biennial IAEA Red Book has compiled voluntarily-submitted information from participating countries: a valuable but necessarily more constrained contribution.

**Figure 3.1 Constant 2006 U.S. Dollars versus Current U.S. Dollars Spot  $U_3O_8$  Prices**

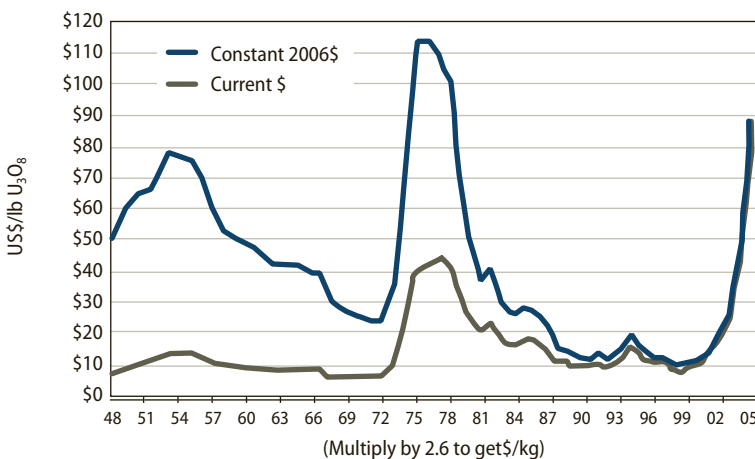

Source: 48–68 US/AEC. 69-86 Nuexco EV, 87-Present  $U_x U_y O_z$  Price

The Red Book Retrospective [6] provides a comprehensive review of the supply, demand, and price of natural uranium over the 1965–2005 time period. Unfortunately, history alone does not provide a particularly good basis for confident future projections. For example, the large parallel swings in uranium and oil prices over this same period are striking, but not amenable to easy interpretation, let alone extrapolation.

Table 3.1, excerpted from the 2007 Red Book, shows the resources for countries having a major share of the uranium market. Table 3.2 lists the actual production in 2006. The dominance by the free market democracies (U.S., Australia, Canada) is noteworthy and reassuring. But also note the extreme reliance of the U.S. on non-domestic suppliers.

**Table 3.1 Worldwide Uranium Resources at < 130 \$/kg (6)**

COUNTRY	IDENTIFIED*	+ UNDISCOVERED**	= TOTAL
	RESOURCES <130 \$/KG 10 <sup>6</sup> METRIC TONS	RESOURCES <130 \$/KG 10 <sup>6</sup> METRIC TONS	RESOURCES <130 \$/KG 10 <sup>6</sup> METRIC TONS
Australia	1.243	NR***	>1.243
Kazakhstan	0.817	0.800	1.617
Canada	0.423	0.850	1.273
Russia	0.546	0.991	1.537
South Africa	0.435	0.110	0.545
USA	0.339	2.131	2.470
All Others	1.666 (37 countries)	2.685 (28 countries)	4.351
TOTAL	5.469	7.567	>13.036
GWe Reactor Years****	27,000	37,800	>65,000

\*Identified = Reasonably assured resources (RAR) + Inferred  
 \*\*Undiscovered = Prognosticated + Speculative  
 \*\*\*NR = not reported  
 \*\*\*\*1 GWe each at 200 MT/GWe yr

### Uranium Resource Bracket Creep

Since its first volume in 1965, the definitive “Red Book” on uranium resources [1] has employed a consistent upper limit for cost categorization of 130 \$/kg U (50 \$/lb U<sub>3</sub>O<sub>8</sub>).

However, this benchmark value is expressed in nominal (i.e., then-current, marketplace) dollars, rather than real (i.e., constant) dollars relative to a benchmark year (although Reference 1 reports actual uranium prices in both current and 2003 constant dollars).

Over the 40-year period, surveyed in reference (1), 1965 – 2005, the U.S. GDP price deflator rose by a factor of 5.0, and the nominal price of U.S. electricity rose by a factor of 4.8 [13]. Thus in 2005 the consistent (with 1965) bracket limit would be about 650 \$/kg U (250 \$/lb U<sub>3</sub>O<sub>8</sub>). At this value, projected resources will be **much** larger than at a 130 \$/kg U cutoff, use of which builds in a pessimistic bias. Reference (1) reports periodic nation-by-nation movement of resources to higher cost categories, but does not distinguish between the effects of higher real dollar production costs and monetary inflation. Nevertheless, it is interesting to note that resources have increased or remained approximately the same in all resource assurance categories since about 1980 for all benchmark levels: < 40 \$/kg, < 80 \$/kg, and < 130 \$/kg [1].

This observation should further assuage concerns over uranium availability. It also argues for adding higher cost categories in future Red Book and other assessments. The Red Book did briefly (1986–1989) include a 260 \$/kg U (100 \$/lb U<sub>3</sub>O<sub>8</sub>) category, which was subsequently dropped when market prices collapsed in the 1990s.

**Table 3.2 Uranium Production in 2006**

COUNTRY	10 <sup>3</sup> METRIC TONS
Australia	7.953
Canada	9.862
Kazakhstan	5.281
Namibia	3.067
Niger	3.443
Russia	3.190
South Africa	0.534
United States	1.805*
Uzbekistan	2.260
All Others (28 countries)	2.208
TOTAL	39.603**

\* ~8% of 2006 requirements of 22.89 x 10<sup>3</sup>  
 \*\* ~60% of 2006 requirements of 66.5 x 10<sup>3</sup>

## ESTIMATING FUTURE COSTS OF URANIUM

We developed a price elasticity model to estimate the future costs of uranium as a function of the cumulative mined uranium. The details of this model are in the appendix.

The primary input is the model of uranium reserves as a function of ore grade [14] developed in the late 1970s by Deffeyes. The results of this model are shown in Figure 3.2. For uranium ores of practical interest, the supply increases about 2% for every 1% decrease in average grade mined down to an ore grade of ~1000 ppm. His work extended models previously applied to individual mined deposits (e.g., by Krige for gold) [15] to the worldwide ensemble of deposits of uranium. The region of interest in the figure is on the left-hand side, above about 100 ppm uranium, below which grade the energy expended to extract the uranium will approach a significant fraction of that recoverable by irradiation of fuel in LWRs. The resources of uranium increase significantly if one is willing to mine lower-grade resources.

An important factor not accounted for here in prediction of uranium resources is the recovery of uranium as a co-product or by-product of other mining operations. The most important category here is phosphate deposits. A recent CEA assessment [8] projects 22 million MT from this source: by itself enough for 1000 one-GWe reactors for 100 years, subject to the caveat that co-production is fully pursued.

Finally, several authors have noted that Deffeyes' assessment was completed before the rich ore deposits in Canada, at grades in excess of 3% (30,000 ppm) were discovered. This could imply that the projected cost escalation based on his results would, in effect, be postponed for a period.

Our model included three other features in addition to uranium supply versus ore grade elasticity:

- ❑ *Learning curve.* In all industries there is a learning curve where production costs go down with cumulative experience by the industry.
- ❑ *Economics of scale.* There are classical economics of scale associated with mining operations.
- ❑ *Probabilistic assessment.* Extrapolation into an ill-defined future is not properly a deterministic undertaking—we can not know the exact answer. Hence, following the lead in a similar effort in 1980 by Starr and Braun of EPRI, a probabilistic approach was adopted [16] in our models.

The results of our model are shown in Figure 3.3 where the relative cost of uranium is shown versus the cumulative electricity produced by LWRs of the current type. The unit of electricity is gigawatt-years of electricity generation assuming that 200 metric tons of uranium are required to produce a gigawatt-year of electricity—the amount of uranium used by a typical light water reactor. The horizontal axis shows three values of cumulative electricity production:

- ❑ G1 = 100 years at today's rate of uranium consumption and nuclear electric generation rate
- ❑ G5 = 100 years at 5 times today's uranium consumption and nuclear electricity generation rate
- ❑ G10 = 100 years at 10 times today's uranium consumption and nuclear electricity generation rate.

Figure 3.2 Deffeyes Log-Normal Frequency Model for Distribution of Uranium in the Earth. [4] [9]

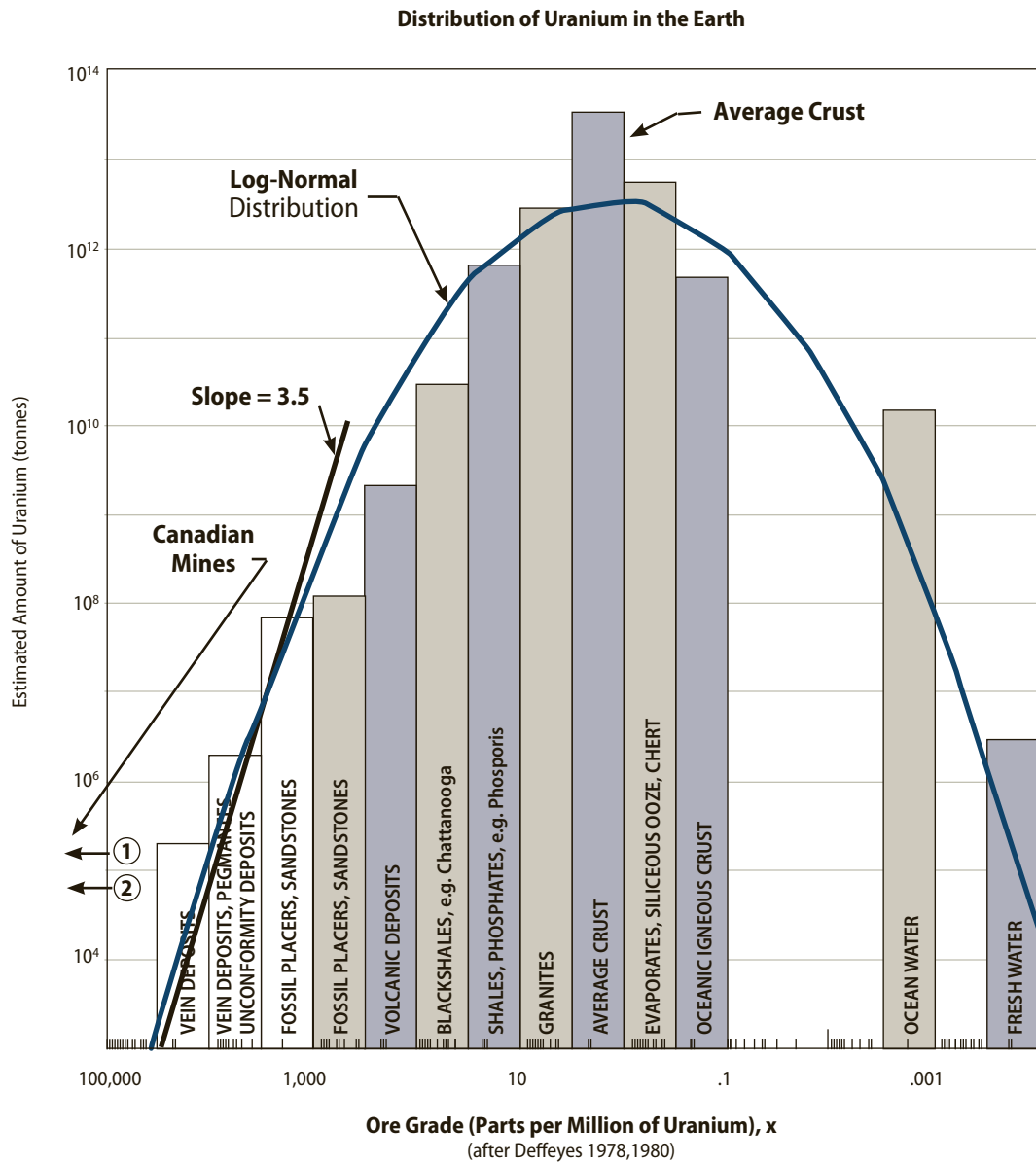

**Figure 3.3 Relative Uranium Cost vs. Normalized Cumulative Nuclear Energy Generation**

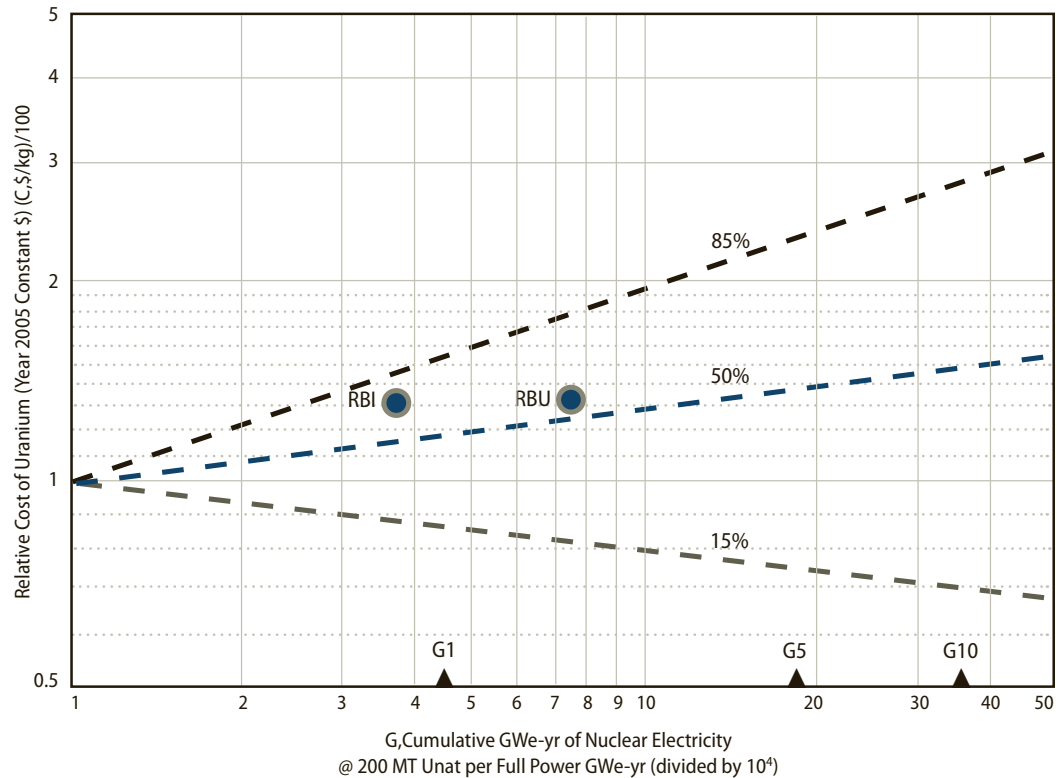

Three lines are shown based on the probabilistic assessment described in the appendix of Chapter 3. The top line is to be interpreted as an 85% probability that the cost relative to the baseline cost will be less than the value on the trace plotted as a function of the cumulative electricity production using today’s LWR once-through fuel cycle. The three lines meet at the far left where the baseline cost of uranium is taken as 100 \$/kg, and the baseline total cumulative nuclear electricity production is (somewhat arbitrarily) taken as 10<sup>4</sup> GWe-yr using 2005 as the reference year. The other lines correspond to 50% and 15% probabilities. As one example at 10<sup>5</sup> GWe-yr cumulative production, there is an 85% probability that uranium will cost less than double 2005 costs (i.e., less than \$200/kg), a 50% probability that it will cost less than 30% greater than 2005 costs, and a 15% probability that it will be 20% or lower in cost.

As another example, if there were five times as many nuclear plants (G5) and they each operated for 100 years, we would expect (at 50% probability) uranium costs to increase by less than 40%. Because uranium is ~4% of the production cost of electricity, an increase to 6% of the production costs would not have a large impact on nuclear power economics.

The two points plotted on Figure 3.3 correspond to 2007 Red Book values for identified (RBI) and identified-plus-undiscovered (RBU) resources at under 130 \$/kg: 5.5 and 13.0 million metric tons. These benchmarks support the expectation that uranium production costs should be tolerable for the remainder of the 21<sup>st</sup> century – long enough to develop and smoothly transition to a more sustainable nuclear energy economy.

## MODELLING UNCERTAINTIES

### Regulatory Impacts

Tighter remediation standards for treatment of mine and mill tailings have been implemented since the early days of uranium mining. Additional stringency in the future can not be ruled out. Since the amount of tailings is very nearly the same as the ore mined (most ores contain less than 1% uranium), the material to be dealt with increases as the ore grade decreases. The model can be adjusted for such contingencies. The effect is tempered somewhat by the fact that the accumulated radionuclide burden due to uranium decay products in the ore is directly proportional to the amount of uranium present; hence, as the ore grade decreases the decay products in the mine and mill tailings also decrease per unit volume of waste. Tougher environmental standards and licensing regimens also increase the time and cost of bringing new mines and mills on line: 10 to 15 years is the current estimate.

### Alternative Fissile Fuel Sources

One can also postulate a band of costs around 300 to 400 \$/kg, corresponding to breakeven with other fuel cycle options, such as LWR recycle, fast breeder reactors, and uranium recovery from seawater. At this point it is premature to be more definitive, since these options may well become more competitive with progress in ongoing R&D in each area. Uranium costs in this range would also correspond to 8 to 12% increase in busbar cost (lifetime levelized for a new plant), which can probably be tolerated without serious adverse effects on the competitive prospects of nuclear versus non-nuclear options.

### Limits of Mineral Exploration for Understanding Resources

Our understanding of all resource predictions is blurred because of the lack of commercial incentives to search for and prove out reserves for more than several decades into the future. Cohen [17] shows that the ratio of reserves to current use rate for nineteen metals varies widely, but with a median of about six decades, coincidentally also his value for uranium. This motivated our development of a geostatistical model, based on Deffeyes' work, to go beyond this time horizon.

### Experience with other Minerals

An even greater contributor to uncertainty — or more appropriate, bias — is the usual failure in resource modeling to credit learning (ingenuity) in process evolution. For example, Shropshire [4] and others have pointed out that industrial metal prices have actually **decreased** (in constant dollars) over the course of the 20<sup>th</sup> century. Figure 3.4 shows the 20<sup>th</sup> century price history for vanadium, a metal having geochemical properties which often associates it with uranium. Its regression coefficient of  $-0.012$  is the same as the mean for the 35 minerals studied [4].

**Figure 3.4 100 Year Price Trend for Vanadium [4]**

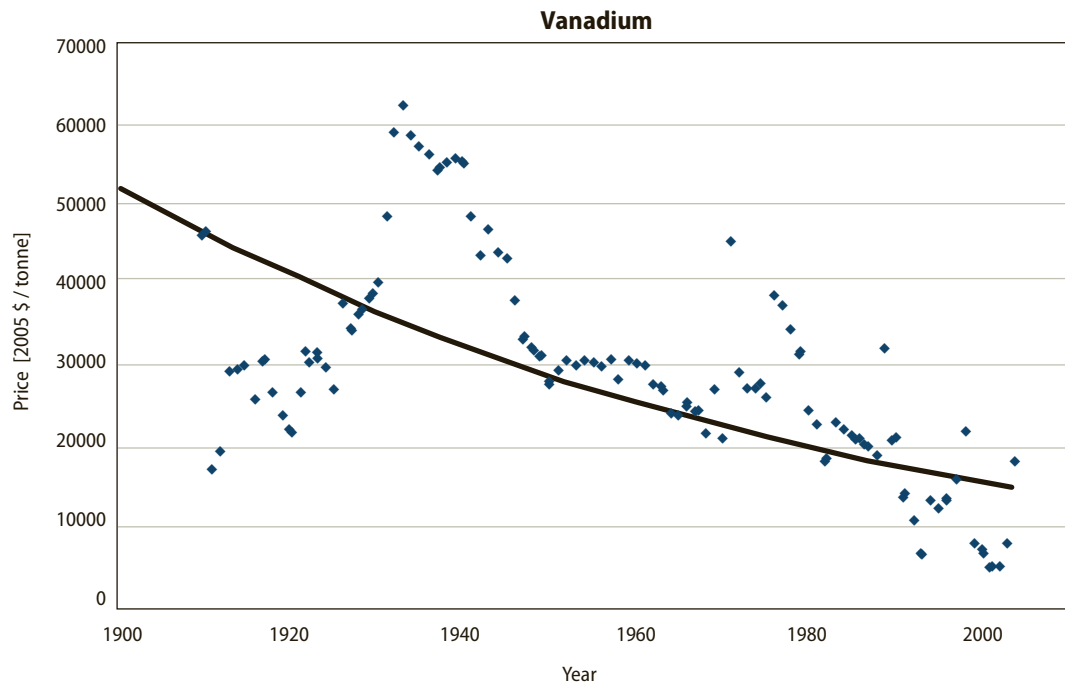

Source: Advanced Fuel Cycle Cost Basis. Idaho National Laboratory INL/EXT-07-12107, March 2008

However, the market history of other metals may not be a valid predictor for uranium for several reasons:

- ❑ Uranium is the only metal in the category of fuel, has only one set of customers, and a very inelastic demand. Nuclear reactors have a long lead time, long life, and are base-load units. Hence, once built, use rate is extremely predictable.
- ❑ Substitution and conservation are not relevant factors. Current LWR physics and fuel management practices are at near-optimum with respect to uranium utilization in current LWRs.[18] (Reactors with high conversion ratios can affect uranium demand—see Chapter 6 and Appendix B).
- ❑ There is no comparable market for inexpensive “scrap metal” recycle. Spent fuel reprocessing and recycle is expensive, currently employed in fewer than 10% of all reactors, and of limited efficacy. Reducing enrichment plant tails composition is equally effective and more easily implemented on a wide scale.
- ❑ Uranium has a unique mill tailings remediation problem due to their radium, hence radon, content, which adds costs.
- ❑ About half of uranium resources are government owned

Understandably, taking to heart the admonition that past performance is no guarantee of future success, few have the temerity to extrapolate declining production cost trends into the future. One motivation is that over the past decade or so there has been increased deployment of a significant innovation in uranium mining: in situ leaching (ISL) – also known as solution mining – in which an oxidizing aqueous solution is pumped into a

uranium-bearing underground formation, and a return stream is processed to recover the dissolved uranium. Not all deposits are suited to this approach (some estimates are ~20%), but significant operations are underway in the U.S. (five such in 2008) and Kazakhstan (20 ISL sites), and, as noted in a recent, comprehensive NRC report [19], large scale expansion is planned for ISL deployment in the U.S..

## Research and Development

Estimates of uranium resources are major inputs into long-term fuel cycle decisions—particularly decisions about when alternative sources of fissile fuel must be developed. There are uncertainties that our models do not address. Because of these factors we recommend a limited international R&D program to better understand uranium costs versus cumulative production.

## URANIUM CONSERVATION MEASURES

LWR units are currently operating at enrichments and burnups close to the optimum for uranium utilization. Of more than a dozen changes evaluated only two offer ore savings of any significance: (1) reprocessing and recycle of plutonium and uranium in spent nuclear fuel (SNF) and (2) reducing enrichment plant tails composition. The two are not mutually exclusive, but the first is considerably more expensive based on the current state of the art.

Single pass recycle of plutonium as mixed oxide fuel (MOX) in LWRs reduces the need for natural uranium per reactor by about 15%, and re-enrichment/recycle of the uranium recovered from spent fuel (RepU) would add another 10%. The current estimate [4] is that MOX costs about 1200 \$/kg more than conventional uranium oxide (UOX) fuel. Re-enrichment of RepU is not widely practiced, as current thinking is that it requires use of a separate dedicated enrichment facility, to limit contamination by contained radionuclides. In the future RepU could be used for blending with HEU or MOX but with small impacts on total uranium resource requirements.

In contrast, a 50% increase in the total amount (hence also total cost) of separative work to reduce the tails enrichment (currently 800 \$/kg of the total 2000 \$/kg for  $UO_2$ ) would decrease uranium ore usage by 22%—as much as the total recycle of plutonium and RepU into LWRs. Similarly lower enrichment costs at economically optimum tails assay make more of the U-235 in natural uranium economically accessible (Appendix 3D). Improved enrichment technologies (such as advanced centrifuge or the GE-Hitachi Silex laser isotopic separation process undergoing engineering tests and licensing) decrease uranium requirements.

Such savings, however, are overshadowed by the large uncertainty in future uranium reserves at a given cost. Our current reference case assumes  $U_{NAT}$  costs 100 \$/kg and that 10 kg  $U_{NAT}$  are required per kg of enriched fuel: hence 1000 \$/kg reload fuel.



## Stockpiling

If supply interruption (or price run-up faster than interest rates) should become an important concern, stockpiling of either natural uranium or fuel-ready LEU would not be an onerous burden, requiring only 200 MT  $U_{\text{NAT}}$  or 20 MT of 4.5% enriched uranium per GWe year. The latter mass is more than  $10^5$  smaller than equally potent coal, oil, or natural gas storage amounts. Hence a strategic uranium reserve could be contemplated.

If one values the current U.S. Strategic Petroleum Reserve of  $7.27 \times 10^8$  barrels (~ 70 days of imports) at 50 \$/bbl, the same investment in natural uranium at 100 \$/kg U would support 100 reactors for nearly twenty years. Hence a stockpile a factor of 5 smaller would provide more than ample protection against short term supply interruption. Alternatively, at about double the cost per kilogram of natural uranium, one can stockpile 5% enriched uranium. This reduces the time delay prior to fuel fabrication and reduces the fuel-ready stockpile mass by a factor of ten. However, the other 90% must still be stored as depleted uranium. As discussed in Chapter 8, a fuel bank is being developed through the IAEA to provide security of supply as part of a nonproliferation strategy.

De facto stockpiles of other types are available:

- ❑ U.S. enrichment plant tails (in excess of 700,000 metric tons [20] containing about 1400 MT U-235 – enough to support up to 14 LWR reactors for 100 years if fully recovered. Cheaper uranium enrichment services should eventually permit cost-effective access to some of this material. World depleted uranium stores are probably comparable.
- ❑ U.S. in situ ore reserves are of on the order of  $2 \times 10^6$  MT  $U_{\text{NAT}}$  (see Table 3.1), not currently being mined because of cheaper supplies from the international market, principally Canada. If eventually recovered, these could sustain 100 reactors for 100 years.
- ❑ In December 2008 the U.S. DOE announced a program to release for commercial use, over a period of 25 years, a variety of excess uranium types totaling roughly 60,000 MT of natural uranium equivalent: i.e., about 300 reactor years' worth [20].

The above considerations buttress the contention that natural uranium resources will not be a major constraint for the remainder of the 21<sup>st</sup> century.

## Effects of Weapon Stockpile Reduction [21]

The United States and Russia reached an agreement in 1993 to blend down 500 tons of 90% enriched uranium for consumption by U.S. LWRs through 2013. One metric ton of HEU can sustain a 1 GWe LWR for approximately 1 year. Hence, the 500 tons of HEU can support five reactors for 100 years – useful but not a major factor when considerably more than 500 reactors could be operational within a few decades (there are currently about 360 operating LWRs globally).

Russia and the U.S. have retained a stockpile of 600 – 1200 MT of HEU, which could again easily be absorbed by the world uranium market. IPFM estimates more than 1700 tons total worldwide. [21]

The current global stockpile of **separated** plutonium is about 500 tons, about half of which is civilian. Its use as MOX LWR fuel would also consume roughly one metric ton per 1 GWe reactor per year.

Thus, in total, these stockpiles could support about thirty reactors for 100 years: there would be important market implications if put on the market in a decade or so, but not in the longer term, especially under a robust growth scenario.

### Other Front End Steps

We have not discussed the conversion (to  $UF_6$ ), enrichment, or fuel fabrication steps which complete the front end of the fuel cycle. See Ref [22] for a comprehensive review of their status and prospects. These services employ proven technology, each available from several commercial vendors worldwide, and we can rely upon the marketplace to expand supply to meet future demand. As such they should not restrict the future expansion of nuclear power. Prices can escalate during periods of short-term scarcity (as for SWU in the 2006-2008 time frame), but should decrease (in constant dollars) relative to uranium costs in the long run due to scale, innovation and learning effects.

## SUMMARY, CONCLUSIONS, AND RECOMMENDATIONS

Based upon a review of published information and analyses, and the present modeling of the cost/resource relationship, there is a high degree of confidence that natural uranium can be provided at affordable costs well into the future. However, the market is in serious imbalance and vulnerable to price volatility until current efforts to expand production come to eventual fruition. Similarly, the worldwide economic turmoil since Fall 2008 may well delay both reactor and front-end facility construction.

These findings support the conclusion that concerns about resource depletion should not motivate premature large scale deployment of alternatives to the current LWR once-through fuel cycle: there is time for a measured pace for introduction of such alternatives.

Given that conclusion, an obvious recommendation is that the practice of making running updates of the uranium resource situation be continued. The trade magazine *Nuclear Engineering International* is a good source of up-to-date information on the entire nuclear fuel cycle, in particular their “Annual Fuel Review” September issues: e.g., Ref [22]. The biennial Red Book is, as noted earlier, the definitive reference on uranium resources. The Red Book 260 \$/kg benchmark should be reinstated, particularly since spot market prices (briefly) topped 364 \$/kg in mid-2007. However, adding even higher cutoffs is problematical because of the lack of near-term financial incentives to do the field work to develop credible estimates. Thus it may be more productive to update Deffeyes’s 1978 analytical modeling approach to deal with these more nebulous categories. At the same time an international research program should be carried out to sharpen understanding of uranium costs versus cumulative production.

An expanded version of this writeup is contained in the SM Thesis by I. A. Matthews [23].

## CITATIONS AND NOTES

1. Uranium 2007: Resources, Production and Demand, OECD NEA No. 6345, 2008 (Red Book)
2. IAEA, 2001, "Analysis of Uranium Supply to 2050"
3. J. S. Herring, 2004, "Uranium and Thorium Resource Assessment," *Encyclopedia of Energy*, Vol. 6, Elsevier
4. D. E. Shropshire et al., 2008, "Advanced Fuel Cycle Cost Basis," INL/EXT-07-12107, Rev. 1, March 2008.
5. E. Schneider, W. Sailor, 2008, "Long-Term Uranium Supply Estimates," *Nuclear Technology*, Vol. 162, June 2008
6. Forty Years of Uranium Resources, Production and Demand in Perspective, 2006, "The Red Book Retrospective," OECD, NEA No. 6096, 2006
7. UIC Nuclear Issues Briefing Paper #75, March 2007, "Supply of Uranium"
8. A. Ganier, "Uranium: The Question of Future Resources," *CEA News*, Issue No. 5, July 2008
9. "National Uranium Resource Evaluation (NURE) Program Final Report," GJBX-42 (83), U.S. DOE (1983)
10. World Uranium Geology and Resource Potential, "International Uranium Resources Evaluation Project (IUREP)," OECD/IAEA, Miller Freeman (1980)
11. NASAP: "Report of the Nonproliferation Alternative Systems Assessment Program," U.S. DOE/NE-0001/1 through 9, June 1980.
12. INFCE: "International Fuel Cycle Evaluation," IAEA, ISP534-1 through 9, 1980.
13. Annual Energy Review 2007, DOE/EIA-0384 (2007), June 2008
14. K. Deffeyes, I. MacGregor, 1978, 1980, "Uranium Distribution in Mined Deposits and in the Earth's Crust," Final Report to U.S. DOE, Grand Junction Office, August 1978; also *Scientific American*, Vol. 242 (1980)
15. G. S. Koch Jr., R. F. Link, "Statistical Analysis of Geological Data," Wiley, 1970
16. C. Starr and C. Braun, "Supply of Uranium and Enrichment Services," *Trans. Am. Nucl. Soc.* Vol. 37, Nov. 1980
17. D. Cohen, 2007, "Earth Audit," *New Scientist*, Vol. 194, No. 2605, 16 May 2007
18. M. J. Driscoll, T. J. Downar, E. E. Pilat, 1990, "The Linear Reactivity Model for Nuclear Fuel Management," American Nuclear Society
19. "Generic Environmental Impact Statement for In-Situ Leach Uranium Milling Facilities," NUREG-1910, May 2009
20. U.S. Department of Energy, Excess Uranium Inventory Management Plan, Dec. 16, 2008
21. Global Fissile Material Report 2007, Second Report of the International Panel on Fissile Materials (IPFM), Princeton
22. Nuclear Engineering International, Annual Fuel Review, Vol. 53, No. 650, Sept. 2008
23. I. A. Matthews, "Global Terrestrial Uranium Supply and Its Policy Implications: A Probabilistic Projection of Future Uranium Costs," SM Thesis, Massachusetts Institute of Technology Department of Nuclear Science and Engineering and the Technology and Policy Program in the Engineering Systems Division, Feb. 2010

# Chapter 4 — Interim Storage of Spent Nuclear Fuel

## INTRODUCTION

Spent nuclear fuel storage is a required step in all open and closed fuel cycles. This is a consequence of the nuclear characteristics of SNF. The radioactivity decreases rapidly with time resulting in radioactive decay heat and gamma radiation decreasing rapidly with time. There are large safety and economic incentives to allow the radioactivity of SNF to decrease before transport, processing, or disposal.

Upon reactor shutdown, SNF is intensely radioactive and generates large quantities of decay heat—equal to about 6% of the power output of the reactor. However, the radioactive decay heat decreases very rapidly reaching 0.5% in one week. The refueling strategy in LWRs is to transfer the SNF from the reactor core to the SNF storage pool (Fig. 1) where the water provides cooling and radiation shielding. In the following decade, the radioactivity after the first rapid decrease in radioactivity will decrease by another factor of 100. Reactor SNF storage is a safety function to provide time for the SNF decay heat to decrease sufficiently that a serious accident can no longer happen.

**Figure 4.1 Wet Storage System — Spent Fuel Pool**

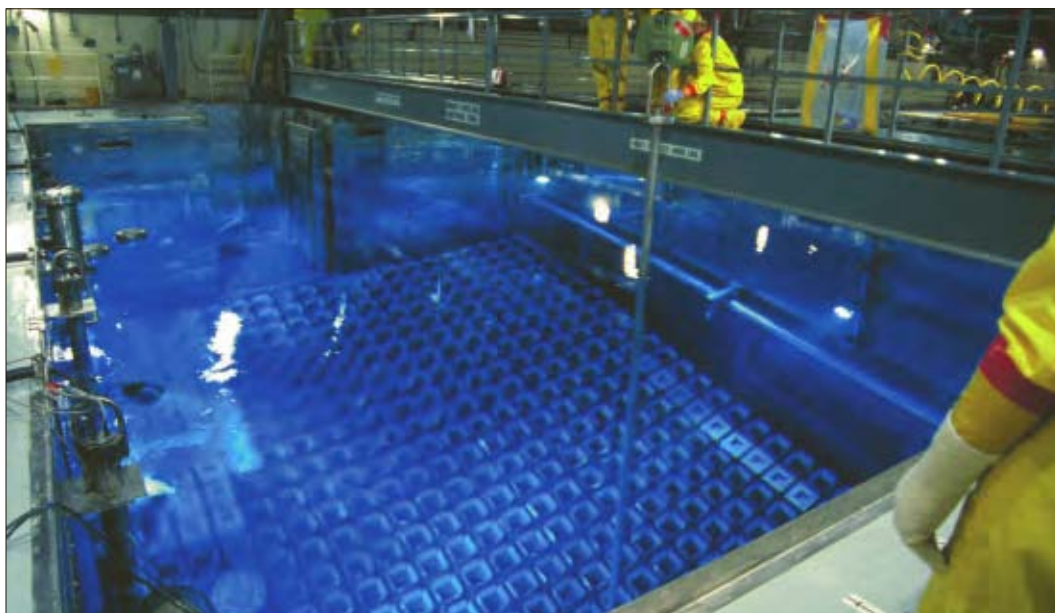

If SNF is to be shipped, typically the minimum time before SNF shipment is 2 to 3 years. However, there are large economic incentives to store SNF for a decade before transport. SNF is shipped in heavy steel casks. With short-cooled SNF, thicker walls are required to provide radiation shielding resulting in less SNF per cask. Cask capacity is also limited by the requirement to limit SNF temperatures to avoid SNF degradation. The radioactive decay heat must be conducted out through the cask walls. A decade of storage enables the use of more-economic large-capacity casks that minimize the number of shipments.

SNF can be transferred for storage from the SNF pool to dry cask storage (Fig. 2). Dry cask storage is a preferred option for long-term storage of SNF because the cask has no moving parts (natural circulation air-cooling for decay heat removal) and requires very little maintenance. Like transport casks, there are economic incentives to store the fuel in the pool for a decade before transfer to dry cask storage.

**Figure 4.2 Schematics of Dry Cask Storage Systems**

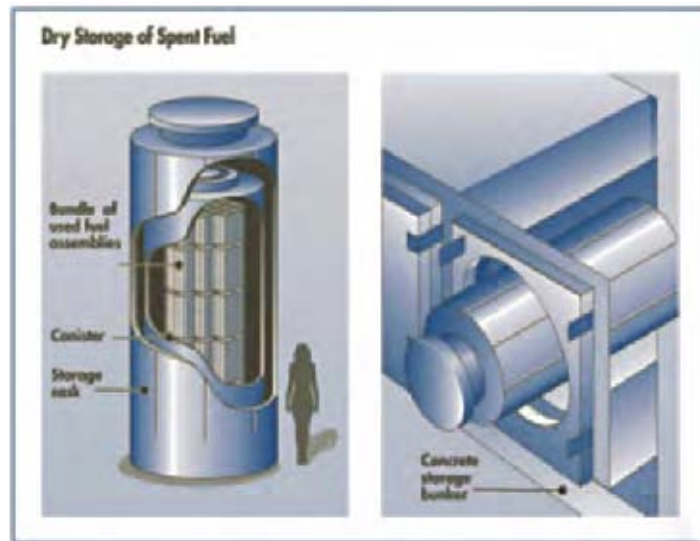

**Figure 4.3 Independent Spent Fuel Installation - Dry Cask Storage**



If SNF is to be disposed of in a repository, it will be stored for 40 to 60 years (Chapter 5: Waste management). Peak temperatures in a geological repository are limited to assure long-term repository performance. If the temperatures are too high, the performance of the waste form, waste package, and geology may be impaired. Peak repository temperatures are controlled by limiting the allowable decay heat per waste package. If the SNF is stored for several decades, the decay heat per ton of SNF decreases, more SNF can be placed in each waste package, the waste packages can be spaced closer to each other underground, the size (footprint) of the repository is reduced, and the cost of the repository is reduced. Like the SNF, the HLW will be cooled for 40 to 60 years before ultimate disposal to reduce the decay heat.

SNF sent to a reprocessing plant may be stored for long periods of time before reprocessing.

- *Product specifications (Appendix E: Status of Fuel Cycle Technology).* In closed fuel cycles, SNF is converted into fresh fuel assemblies and wastes for disposal. One complication is that each SNF assembly has different plutonium isotopes. To fabricate fresh fuel assemblies with the proper plutonium isotopic content, selected SNF assemblies are chosen so when reprocessed together as a batch, the plutonium isotopic specifications for the plutonium fuel are met (Appendix E). This is conceptually similar to the recycle of steel where different grades of scrap metal are mixed together to produce a recycle steel that meets product specifications. In both cases, large inventories of recycle materials help provide the right selection of feed materials to produce the desired products.
- *Reduced reprocessing costs.* As SNF ages and its radioactivity and decay heat decrease, it becomes easier and less expensive to reprocess.

The requirement for SNF storage to allow decreases in decay heat resulted in several countries building centralized facilities for SNF or HLW storage in the 1980s to age the wastes before disposal. The U.S. passed laws requiring disposal of SNF on a specific schedule without considering storage; however, those legal requirements did not change the need for storage. The technical solution at the proposed Yucca Mountain repository was to place the SNF in waste packages, put the waste packages in the repository, and cool the repository with air flow through the disposal drifts for 50 years after the repository was filled. The strategy of SNF storage (at the reactor, a centralized storage facility, or a ventilated repository), wherever it is done, significantly reduces the size and cost of the repository. In effect, the proposed Yucca Mountain repository would have been functionally a SNF storage facility that would be functionally converted into a geological repository after the 50-year cooling of the SNF.

## **RECOMMENDATION FOR SNF STORAGE FOR UP TO A CENTURY**

Technical and economic factors define nominal SNF storage times—60 to 70 years in the proposed Yucca Mountain system. These storage times may be increased or decreased by policy considerations. Technical and policy considerations have led to our recommendation that:

*Planning for long term managed storage of spent nuclear fuel—for about a century—should be an integral part of nuclear fuel cycle design.*

SNF is a significant potential source of energy; however, we do not know today if LWR SNF is a waste or a valuable national resource. Because of this uncertainty, we recommend

a policy that maintains fuel cycle options—long-term storage of SNF. There are several factors that lead to this conclusion

- *There is no incentive today to recycle SNF.* Economic uranium resources will be available for most of this century (Chapter 3). Current waste management technologies can safely dispose of SNF (Chapter 5). The cost to recycle LWR SNF is greater than making new fuel from mined uranium (Chapter 7).
- *The energy content of SNF is significant and thus the incentive to maintain the option of future use of SNF.* The historical vision of the future of the nuclear fuel cycle was that LWR SNF is a valuable resource. Plutonium from LWR SNF was to be recovered and fabricated into fuel for the startup of fast reactors. Such a system could increase the available energy from uranium by more than an order of magnitude.
- *New fast-reactor technologies may not require plutonium from LWR SNF.* Advances in technology indicate that fast reactors may be started up on low-enriched (<20% <sup>235</sup>U) uranium and thereafter continue operation with fast reactor SNF recycle and the addition of depleted or natural uranium. If successfully developed, this technology would have today significantly lower costs than startup of fast reactors with plutonium recovered from LWR SNF. With startup on low-enriched uranium, fast reactor deployment would not be limited by the availability of plutonium from the reprocessing of LWR SNF—a strategy that also reduces long-term uranium demands by allowing the option of large-scale deployment of fast reactors earlier in time (Chapter 6). Fast reactor SNF has a fissile content an order of magnitude higher than LWR SNF—thus the economics of recycling fast reactor SNF may be different than for LWR SNF.
- *Long transition times to new fuel cycles.* Dynamic modeling of alternative fuel cycles (Chapter 6) reveals that the transition from one fuel cycle to another takes 50 to 100 years. This reflects the long lifetimes of nuclear power plants and the several decades for the industrial implementation of any alternative fuel cycle. It implies that if we knew what future fuel cycle we wanted, the planning horizon for SNF storage would be on the order of 50 to 100 years. Today we do not have the information to make wise decisions on what fuel cycle or fuel cycles we should adopt: the future scale of nuclear power is uncertain—a factor with major implications on fuel cycle choices, alternative fuel cycle options have been identified but it will take time to understand what the preferred option or options are, and the preferred economic choices are unclear. There is also no national consensus on what should be our fuel cycle goals (Chapter 2) but some type of broad consensus is required for any option requiring several decades to fully deploy.

This recommendation is not a recommendation to slow the development of a geological repository. Permanent geological isolation will be required (Chapter 5) for at least some long-lived components of SNF, and so systematic development of a geological repository needs to be undertaken. Furthermore, the U.S. has today significant inventories of defense high-level waste and small quantities of commercial high-level glass that are ready for geological disposal. *Rather our recommendation is based on the benefits to maintain future options, the benefits to waste management of SNF storage before disposal, and the relatively low-cost of SNF storage.*

Storage is a viable option because the quantities of SNF are small and the costs of storage are small relative to the value of electricity produced. A typical reactor produces 20 tons of SNF per year. The U.S. generates ~2000 tons of SNF per year in the process of producing ~20% of

the total U.S. electricity. Total waste management costs (including SNF storage) are between 1 and 2% of the cost of electricity.

### **Intergenerational Equity**

Intergenerational equity addresses the issue of burdens and benefits to different generations. The “achievement of intergenerational equity” is one of the cornerstones of nuclear waste management and one of the reasons for choosing geological repositories for the ultimate disposal of nuclear waste so as to minimize burdens to future generations. In the context of SNF storage, there are benefits to maintaining options for future generations and burdens associated with storage.

We undertook a study on intergenerational equity to understand and clarify these issues in the broad context of sustainability and fuel cycle choices. The study puts forward a way of assessing future fuel cycles in accordance with the intergenerational equity criteria presented as a broadly defined set of *moral* values built around the principle of sustainability. These values are characterized as moral values since they contribute to the environment and humankind’s safety and security as well as an overall welfare of society in terms of sustainability. A summary of our analysis is in Appendix D

In the context of spent fuel, an important conclusion of the analysis is that net risks and benefits are partly dependent upon the availability of future technologies. Preservation of options also argues for repository design with reversability and retrievability. This points to an important benefit of preserving options that do not elevate risk. This has been the subject of recent major international studies.<sup>1</sup>

### **OPTIONS FOR LONG-TERM SNF STORAGE**

There are many options for long-term storage of SNF. The three major options for LWR SNF are: pool storage at the reactor or a centralized site, dry cask storage at the reactor or a centralized site, and storage in a repository to allow retrievability. All can provide long-term safe SNF storage. Centralized storage has become the preferred option for most countries (France, Japan, Sweden, etc.) with significant nuclear power programs.

All LWRs use short-term pool storage of SNF. Pool storage is used for centralized long-term storage of SNF at the CLAB facility<sup>2</sup> in Oskarshamn, Sweden. This facility, located 30 meters underground, has a capacity of 8000 tons of SNF with a current inventory of 5000 tons. It opened in 1985 with the specific goal to store SNF until the decay heat decreased sufficiently for disposal in the planned Swedish repository at Forsmark. When CLAB was built, pool storage was the only technology for long-term storage of SNF. Pool storage is also used at reprocessing plants because it allows easy retrieval of specific fuel assemblies to be reprocessed as a batch. France, Russia, Great Britain, and Japan have centralized pool storage of SNF to support their associated reprocessing plant operations. In the U.S., General Electric built a medium-size reprocessing plant at Morris, Illinois but technical difficulties were found during testing; thus, the plant was never operated. The storage pool built to support that plant is now a centralized SNF storage facility for the SNF that was to have been reprocessed.



Dry cask storage is used for short and long-term storage of SNF. As discussed later in this chapter, it is a modular storage technology that is the chosen long-term SNF storage technology in the United States and is used around the world. Dry cask storage is also used for centralized SNF storage in Germany at Gorleben.

Repositories can be designed for retrievable SNF storage. The proposed Yucca Mountain Repository in the United States was designed to remain open for 50 years after final loading of SNF to provide air cooling of waste packages with the option for retrievability if safety issues were found with the repository.<sup>3</sup> The French repository<sup>4,5</sup> is designed to enable waste recovery for extended periods of time to provide higher confidence to the public. There are also repository designs to enable SNF recovery in salt<sup>6</sup> and other geologies. In these examples the SNF is designed to be retrievable to meet a variety of different goals. There would be limited design modifications if the goal was retrievability with the policy goal of maintaining the option to recycle SNF.

## **SNF STORAGE FOR THE UNITED STATES**

*The possibility of storage for a century, which is longer than the anticipated operating lifetimes of nuclear reactors, suggests that the United States should move toward centralized SNF storage sites—starting with SNF from decommissioned reactor sites and in support of a long-term SNF management strategy.*

Ideally such storage sites would be at repository sites or at sites capable of future expansion to include reprocessing and other back end facilities if the U.S. chooses a closed fuel cycle. While this recommendation is made in the context of a better long-term fuel cycle system, it also addresses two near-term issues: SNF at decommissioned sites and federal liability for SNF storage.

The federal liability for SNF storage is a result of changing federal policies and delays in the repository program. At the time when most nuclear power plants were built in the United States, it was assumed that LWR SNF would be reprocessed. The plants were built with limited SNF storage capacity because of the expectation that SNF would be shipped within a decade to reprocessing plants for recovery and recycle of plutonium.

The U.S. government decisions in the 1970s to not allow commercial reprocessing and the resultant national decision to directly dispose of SNF ultimately led to a decision to ship SNF from reactors directly to a geological repository. Under the Nuclear Waste Policy Act, utilities signed contracts with the federal government for disposal of SNF with removal of SNF from reactor sites starting in 1998. As reactor SNF storage pools filled and it became evident that the U.S. government would not meet its contractual obligations to receive SNF, utilities began to construct modular dry cask storage systems for their SNF to enable continued operations of the reactors.

There is a growing national taxpayer obligation to utilities for failure of the Department of Energy to remove spent fuel beginning in 1998 from nuclear plant sites according to contracts signed with the DOE. The costs are meant to cover the expenses utilities have incurred to build their own dry cask storage facilities at their sites. It is estimated that this obligation would total \$11 Billion by 2020. By that time most of the utilities will have built

their own Independent Spent Fuel Storage Installations (ISFSI) for which the government will have to pay under court decisions.

We analyzed SNF storage costs for at reactor and consolidated SNF storage to understand the economic implications of alternative SNF storage strategies.<sup>7</sup> These “sunk” costs affect the economics of building a central spent fuel storage facility since the marginal cost of operating an ISFSI while a nuclear plant is operating is relatively small. Thus, when the ongoing costs of paying utilities for at-reactor storage are included as a sunk cost, these expenses plus those of building a centralized ISFSI and transporting spent fuel from operating sites is likely not to be economically justified since it does not reduce costs but adds to the costs of waste management. This is not true for sites that have been decommissioned leaving only the ISFSI in place with relatively high annual operating costs which the government (taxpayer) is also obligated to pay. By clearing these sites, the government obligation ceases.

The most recent capital cost estimate for a centralized ISFSI of 40,000 MTHM (20 years of SNF generation in the United States at the current rates) is about \$560 Million which includes design, licensing, and construction of the storage pad, cask handling systems, and the rail infrastructure (locomotive, rail cars, transport casks, etc). Annual operating costs during loading are estimated to be \$290 million per year which includes the costs of the dual purpose canisters and storage overpacks. Fully loading this size ISFSI will take 20 years followed by a period of “unloading” and eventual decommissioning. The middle period of “caretaking” is estimated to cost about \$4 million per year compared to caretaking decommissioned reactor costs for \$8 million per year per site. The cost savings from consolidating the spent nuclear fuel from decommissioned sites is a compelling motivation for the federal government to create a centralized storage installation or facilitate transfers between decommissioned and active reactor sites. Such a policy would also “free up” the decommissioned sites for economic redevelopment, which can be especially attractive since such sites were originally chosen to have access to water, transportation, and the electrical grid.

The Private Fuel Storage Company (PFS), a utility consortium, designed and licensed an ISFSI in Utah that has not been built. PFS has updated its cost for a centralized facility in 2009 dollars to indicate that the cost of an ISFSI is \$118 Million assuming it is operated as a federal facility with no taxes paid. The cost of the rail infrastructure for the PFS, including transport casks and all handling equipment, is estimated to be \$53 Million plus an additional rail extension to the site of \$34 Million. Dedicated trains are assumed with 3 casks per train assumed in the analysis. Annual operating expenses for loading and unloading casks are approximately the same at \$8.8 million. The PFS numbers do not include the costs of the waste canisters or storage overpacks which are assumed to be shipped to the site from the reactors.<sup>8</sup>

The rail infrastructure costs are considerably different at \$53.2 million compared to Electric Power Research Institute estimate of \$366 million due largely to a smaller number of locomotives needed (4 vs. 14) and associated cask shipping cars for the same 2000 MTU per year of shipments to the interim storage site. PFS calculates the cost to ship 3 casks per train to be \$75 per mile with dedicated trains. The PFS numbers shown reflect actual cost estimates for their project in Utah. Reconciliation of these numbers with EPRI cost assumptions is difficult but some obvious differences are that EPRI assumes only two casks per train and a site that has considerably higher capital cost for construction compared to what PFS expects.

*For decommissioned sites, our economic modeling of the net present value—comparing at-reactor storage with centralized storage at a number of reference locations in the east, west and mid-west—show significant advantages for consolidation at centralized sites. This is due largely to the cessation of government payments for spent fuel storage at shutdown sites once cleared of spent fuel. A second important result is the relative indifference of costs to site location despite the significant real distance between sites. Transportation costs are not a major cost driver. This implies that policy makers have wide flexibility in siting a central facility, a flexibility that should come in handy considering past experience.*

A higher degree of confidence is required in the accuracy of the cost parameters used for transportation costs and O&M costs at active sites. If transportation costs are sufficiently low, and O&M costs sufficiently high, it would be cost-advantageous to consolidate SNF from active sites. Our analysis preliminarily supports this finding. This would create a regular stream of SNF to be consolidated, and in turn improve the relative costs of dedicated transport. The dedicated train scenarios do show that the use of dedicated trains can be advantageous in terms of lowering the overall costs of management of spent fuel in interim storage from all sites since it more effectively utilizes the dedicated train capacity.

*It should be noted however, that when the sunk costs of existing at reactor ISFSI's are included in the overall cost of constructing and operating new central storage facilities, it is cheaper to keep the spent fuel at the active reactor sites. Many of the costs of spent fuel storage, such as security, are almost independent of the quantity of spent fuel that is stored at a site. For sites with operating reactors producing spent fuel and having existing ISFSIs, removal of some SNF has little impact on site operational costs.*

*The results of the assessment show that there are significant incentives today for a small centralized storage facility (~3000 tons) to address SNF from decommissioned reactor sites that would be expandable when other operating reactor sites are decommissioned, likely in the 2030 timeframe. Again this is because many of the costs associated with spent fuel storage are nearly independent of the quantity of spent fuel being stored. If centralized storage was built and available, some utilities at sites with operating reactors might choose to ship SNF to such a facility while many utilities might choose to store SNF for appropriate payments of sunk storage costs while the reactor sites had operating reactors.*

Despite the lower system costs of maintaining on-site storage for currently operating reactors, it may be desirable for other reasons to start moving SNF from operating reactor sites (but with priority still afforded to decommissioned reactors): public acceptance; facilitating new reactor construction in a number of states; straightforward resolution of federal liability for its failure to start moving SNF in 1998.

For new reactor sites, the economically preferred option would be shipment of SNF to centralized sites after the initial cooling period, as is done in countries such as Great Britain, France, Russia, and Sweden. A long-term SNF management strategy that contemplates both century-scale storage and the possibility of substantial new reactor construction and operation argues for moving towards centralized storage sites sooner rather than later.

## **SAFETY OF SNF STORAGE**

*While managed storage is believed to be safe for these periods, an R&D program should be devoted to confirm and extend the safe storage and transport period.*

With the possible long term storage of spent fuel approaching 100 years in a combination of wet and dry storage, the technical data supporting such timelines was reviewed.<sup>9,10</sup> The Nuclear Regulatory Commission has determined that “spent fuel generated in any reactor can be stored safely and without significant environmental impacts for at least 60 years beyond the licensed life of operation (which may include the term of a revised or renewed license) of that reactor in a combination of storage in its spent fuel storage basin or at either onsite or offsite independent spent fuel storage installations<sup>11</sup>—a SNF storage time exceeding 100 years. However the actual data supporting such a conclusion is limited to a physical inspection of a low burnup fuel assembly after 15 years of dry storage. High burnup fuels currently used and that are in storage have not been inspected to determine whether their behavior in storage will be similar to low burnup spent fuel. Assuming that the integrity of the storage canisters is not breached allowing for air ingress, storage for long periods should be possible despite continuing degradation mechanisms due to the reduction over time of the temperature of the spent fuel. Presently, NRC licenses dry cask storage installations for 20 years but has recently changed its rule (effective May 17, 2011) to allow for initial 40 year storage periods with 40 year renewals provided that sufficient technical information is available to justify such long storage periods.

While the technical justification of long term dry cask storage may be established, additional technical justification will be needed to assure that spent fuel integrity (suitable for subsequent handling and transport) are met and that the integrity of the canisters can be maintained. Confirmatory research involving spent fuel inspections of high burnup fuel in dry casks and more extensive degradation modeling to provide adequate justification for expected periods of storage of the order of 100 years or more should be supported.

## **SITING OF CENTRALIZED STORAGE FACILITIES**

Strong non-economic arguments can be made for building a centralized interim storage facility. These include addressing the public concern about new plant construction and associated long term nuclear waste storage at plant sites, demonstrating the spent fuel can be safely transported, setting the stage for ultimately clearing out all sites either to a reprocessing plant or a repository. These are in addition to addressing the stranded nuclear waste at fully decommissioned nuclear plants. All are seen as important public confidence building initiatives to support the continued use of nuclear energy.

The siting of a centralized regional interim storage facility will be difficult—partly because of a legacy of previous waste management programs. Past volunteer efforts authorized by Congress with the creation of the Nuclear Waste Negotiator to site a Monitored Retrievable Storage facility failed due in part to political opposition and congressional political interference in the process once decisions were near. There are no indications that there are any fundamental changes either in the politics of siting interim facilities or the willingness of states and local communities to accept such a facility. Some suggest that co-locating a reprocessing plant, collocation of nuclear R&D infrastructure, and an interim storage facility

with its attractiveness of jobs and economic stimulus might be a differentiator today, but that remains to be seen.

An option to address the decommissioned plants is to co-locate decommissioned SNF at an existing decommissioned plant ISFSI in a community willing to host spent fuel from other plants or at an active reactor site. The chances of succeeding in this effort are unknown but depend on the willingness of the community and state to accept such a solution. This might be a first near-term test of the concept of finding volunteer sites in a community that understands the real meaning of spent fuel storage and past nuclear operations. Overseas most centralized storage facilities are located at existing nuclear sites.

The Nuclear Waste Policy Act, as Amended in 1987, severely restricts the Department of Energy from building an interim waste storage facility until Yucca Mountain obtains an operating license. *This legislative restriction needs to be removed to allow the construction of such a facility independent of the progress on a repository site.* Private utility efforts at building a regional interim storage facility such as the Private Fuel Storage (PFS) project have also been stymied by national and state political opposition despite being granted a Nuclear Regulatory Commission license to build and operate such a facility after a 10-year licensing process.

If a volunteer site is found, the licensing process could last 10 years with another 3 to 5 years for construction before spent fuel could be accepted by the facility. Also needed is the establishment of a transportation infrastructure to ship the spent fuel casks to the facility, which could be done concurrently. This process could be expedited if existing federal facilities that have the requisite land, security and infrastructure could be used. Since the PFS site already has an NRC license, time would be saved if that site proved to be politically viable.

## CONCLUSIONS

Planning for long term managed storage of spent nuclear fuel—for about a century—should be an integral part of nuclear fuel cycle design. Long-term managed storage preserves future options for SNF utilization at little relative cost. Maintaining options is important because resolution of major uncertainties over time will determine whether LWR SNF is to be considered a waste destined for direct geological disposal or a valuable fuel resource for a future closed fuel cycle.

Preservation of options for future fuel cycle choices has been undervalued in the debate about fuel cycle policy. Managed storage can be done safely at operating reactor sites, centralized storage facilities or geological repositories designed for retrievability (an alternative form of centralized storage). While managed storage is believed to be safe for these periods, an R&D program should be devoted to confirm and extend the safe storage and transport period.

The possibility of storage for a century, which is longer than the anticipated operating lifetimes of nuclear reactors, suggests that the United States should move toward centralized SNF storage sites—starting with SNF from decommissioned reactor sites and in support of a long-term SNF management strategy.

These broad recommendations lead to specific recommended actions. Remove SNF from decommissioned reactor sites to a secure national facility that has the infrastructure to support long term storage. The PFS experience has demonstrated the licenseability of a consolidated storage site. If a policy decision is made on recycling, collocate interim storage, reprocessing, and fuel fabrication (with recycled fissionable materials) facilities. This would minimize future storage and transportation costs and minimize proliferation risks. Legislation should be introduced to remove the linkage between the repository and the construction of an interim storage facility.<sup>12</sup> Spent fuel retrievability should be considered for any repository to preserve options.

## CITATIONS AND NOTES

1. OECD Nuclear Energy Agency, *Proc. International Conference and Dialogue on Reversibility and Retrievability in Planning Geological Repositories*, Reims, France (December 14-17, 2010).
2. [www.skb.se](http://www.skb.se)
3. U.S. Department of Energy, *License Application for a High-Level Waste Geological Repository at Yucca Mountain*, (June 3, 2008)
4. [www.andra.fr/international/index.html](http://www.andra.fr/international/index.html)
5. ANDRA, *Dossier 2005: Andra Research on the Geological Disposal of High-Level Long-Lived Radioactive Waste: Results and Perspectives* (2005)
6. Office of Nuclear Waste Isolation, *Conceptual Designs for Waste Packages for Horizontal or Vertical Emplacement in a Repository in Salt*, BMI/ONWI/C-145 (June 1987)
7. A. C. Kadak and K. Yost, *Key Issues Associated with Interim Storage of Used Nuclear Fuel*, Center for Advanced Nuclear Energy Systems (CANES), MIT-NFC-TR-123, Massachusetts Institute of Technology, Cambridge, MA (December 2010).
8. There have been only limited shipments in the U.S. in recent decades of SNF. However, the U.S. navy regularly ships SNF from nuclear navy maintenance facilities to storage facilities in Idaho. Overseas (France, Great Britain, Sweden, Japan, etc.) there is a massive experience base in shipping commercial SNF. European experience with SNF shipment is roughly equivalent to that required to fill a repository of the size of Yucca Mountain (See *Going the Distance, The Safe Transport of Spent Nuclear Fuel and High-Level Radioactive Waste in the United States*, National Research Council (2006), Table 3.5)
9. A. C. Kadak and K. Yost, *Key Issues Associated with Interim Storage of Used Nuclear Fuel*, Center for Advanced Nuclear Energy Systems (CANES), MIT-NFC-TR-123, Massachusetts Institute of Technology, Cambridge, MA (December 2010)
10. United States Nuclear Waste Technical Review Board, *Evaluation of the Technical Basis for Extended Dry Storage and Transportation of Used Nuclear Fuel*, December 2010
11. U.S. Nuclear Regulatory Commission, "Consideration of Environmental Impacts of Temporary Storage of Spent Fuel After Cessation of Reactor Operation," 10CFR Part 51, *Federal Register*, **75**, No. 246, December 23, 2010
12. There are large technical, economic, and non-proliferation incentives to collocate reprocessing and recycle fuel fabrication facilities at either interim SNF storage sites or at the repository site (Chapter 5). The traditional vision of the fuel cycle with separately sited storage, reprocessing, fuel fabrication, and repository facilities is an accident of history that resulted from the sequence of development of early nuclear fuel cycle facilities associated with national security.



# Chapter 5 — Waste Management

It has been three decades and five presidents since the determination to deal with civilian radioactive waste was first proclaimed. One generation later, the United States still lacks an integrated nuclear waste management strategy, contributing to a public perception that the radioactive waste problem cannot be readily solved.

The United States has shown that it can effectively manage waste storage facilities for low-level and transuranic waste. It is the only country in the world that has successfully licensed, constructed and now operates a deep geological repository for *defense-generated* radioactive waste, the Waste Isolation Pilot Plant (WIPP). This chapter discusses the issues and obstacles that have prevented similar progress on SNF from power reactors and presents recommendations to move forward.

Our analysis centers on the following observations and findings.

1. All fuel cycles generate long-lived radioactive wastes that can not be practically destroyed; thus, all fuel cycles require a geological repository to support the disposal of radioactive wastes.
2. Spent nuclear fuel from LWRs has a high residual energy content, is stable for a long time when isolated from the environment, and can be processed to recover the fissile and fertile materials for reuse in the future.
3. Historically, fuel cycles in the United States have been developed independently of waste management although there are large economic and risk-reduction benefits for treating waste management as an integral part of the fuel cycle.
4. The United States does not have an integrated waste management system but rather an ad hoc system to address specific wastes. This has resulted in orphan wastes with no disposition pathways, high costs, and a system that will have increasing difficulties if an alternative fuel cycle was adopted.
5. There have been technical and institutional failures in waste management in the U.S.

This analysis leads to several recommendations.

1. A risk-based waste management strategy should be adopted with (1) a waste classification system based on the radionuclide, chemical, and physical characteristics of each waste stream with (2) corresponding disposal facilities for each category of wastes. This is needed to manage existing wastes and required to establish a rational basis for the future management of wastes that could be generated by future fuel cycles. Implementation will require both regulatory and statutory actions.



2. The United States should create an independent organization (with no additional responsibilities) for the management of all long-lived radioactive wastes—including high-level waste (HLW) and spent nuclear fuel (SNF). This includes long-term storage of HLW and SNF, siting of repositories, and operation of such facilities.
3. Waste management (including SNF storage) must become an integral part of the development of any fuel cycle, including an open fuel cycle. The impact of waste management must be assessed and properly reflected in cost and risk evaluations of alternative fuel cycles.

## **RADIOACTIVE WASTE SOURCES, CATEGORIES, AND DISPOSAL FACILITIES**

### **Origins of Radioactive Waste**

There are three main sources of radioactive waste. Defense operations have generated large quantities of wastes. These wastes are primarily the byproduct of nuclear weapons production. Smaller quantities of wastes are generated by nuclear navy operations—including SNF. Commercial nuclear power generates wastes from the fuel cycle and reactors. The primary waste form is SNF, which consists of highly radioactive fission products and actinide elements, and is classified as high-level waste. A 1000 MWe LWR generates ~20 tons of SNF and 250-350 m<sup>3</sup> of other radioactive wastes (primarily low-level wastes (LLW)) per year. Other wastes result from research and development; accelerators, medical, industrial operations; and natural occurring materials.

There are significant differences between historical defense wastes and those from the nuclear power fuel cycle. The operations of defense facilities resulted in the radioactivity being in dilute forms not suitable for direct disposal. Large-scale waste processing operations are required to convert these wastes into forms suitable for disposal. In contrast, SNF from electricity production is highly concentrated and generally in chemically stable forms. Most of these wastes, including SNF, can be packaged and disposed of directly.

### **Waste Categories<sup>1</sup>**

Radioactive wastes are divided into categories. How a waste is categorized is central to how it is managed. Wastes classified as municipal garbage, construction debris, and chemical waste are treated differently because they have different characteristics and create different risks to the public. Similarly, different classes of radioactive wastes are treated differently.

Radioactive nuclides decay to nonradioactive nuclides. Different radioactive wastes require different lengths of time before they become nonhazardous. The waste classification system divides radioactive wastes into categories primary based on the time the wastes remain hazardous. Different types of disposal facilities are required for a waste that remains hazardous for years versus a waste that is hazardous for thousands of years. The process of radioactive decay generates heat. If a waste is highly radioactive it will generate significant decay heat that requires special engineering features in the disposal facility to prevent excessive temperatures. Radioactive waste classification systems also categorize waste by its heat generation rate because it defines what type of disposal facility is required.

Different countries have different waste classification systems that fall into two major categories: those that are based on “where” the waste was generated (point of origin) and those that

are based on the “intrinsic qualities” of the material (risk based). The United States adopted a point of origin system whereas the international community today uses a risk-based system.

For example, in the United States HLW is defined by the Atomic Energy Act of 1954 as the “first cycle raffinate” from a nuclear fuel reprocessing plant—the original source of HLW. Such a technology-based definition assumes (1) a specific reprocessing technology that generates a “first cycle raffinate” and (2) only reprocessing plants with “first cycle raffinates” will generate highly-radioactive materials that should be defined as high-level wastes. This was a reasonable approach for what was known in 1954; but, the assumptions it was built upon are no longer true. SNF is now defined as HLW.<sup>2</sup>

Because the U.S. has not updated its waste classification system, the United States today has an inconsistent, unstructured, and ad hoc waste classification system. Table 5.1 shows the U.S. classification system for radioactive wastes with different categories for defense wastes and civilian wastes. Various regulatory patches have been used to protect public health and safety, but with several consequences:

- *Unknown requirements and costs to treat new types of wastes.* Many proposed fuel cycles would create new types of waste but the regulatory structure for disposal of many such wastes does not fully exist in the U.S.<sup>3</sup> Without a comprehensive waste classification system it is not possible to compare the waste management costs and risks of different fuel cycles without making arbitrary assumptions.
- *Orphan wastes.* The U.S. has some types of waste that do not have an agreed upon disposition path. An example is the disposition of depleted uranium that is classified by default as Class A low level waste (LLW) although its radiological characteristics are very different from other wastes classified as Class A LLW<sup>4</sup>. There is an ongoing multi-decade regulatory effort to categorize this waste and thus define disposal requirements.

In most major nuclear countries wastes are categorized by their content, not the source of the waste. These waste classification systems are similar to that recommended by the International Atomic Energy Agency. The IAEA recommends a risk-based system that accounts for the intensity of the radiation and the time needed for it to decay to an acceptable level. The intensity of radiation is given by a range of radioactivity per unit of weight. Decay time is split into short lived (< 30 years) and long lived (>30 years). There is no distinction in either categorization or disposition options based on the sources of nuclear waste.

## Disposal facilities

The U.S. has built disposal facilities for various defense and commercial radioactive wastes. The combination of the proposed YM repository, the Waste Isolation Pilot Plant (WIPP), and other waste facilities have the capability to dispose of all defense- and civilian-generated wastes; however, each facility is limited to specific wastes from specific sources rather than being disposal facilities for all wastes in a particular category. The WIPP repository is designed to isolate long-lived low-heat radioactive wastes but is legally restricted to defense transuranic wastes—the largest category of such wastes. The proposed YM repository or an equivalent facility would be technically capable of disposing of all long-lived wastes from any fuel cycle. However, the license application for the proposed YM repository was only for the disposal of SNF and HLW—it did not address the disposal of small quantities of orphan wastes generated by today’s once-through fuel cycle requiring geological disposal. A

**Table 5.1 United States Waste Classification System\***

DEFENSE WASTE	
WASTE CLASS	DESCRIPTION
HLW	Highly radioactive waste material resulting from the reprocessing of SNF, including liquid waste produced directly in reprocessing and any solid material derived from such liquid waste containing fission products in sufficient concentrations; and other highly radioactive materials determined, consistent with existing law, to require permanent isolation.
Transuranic (TRU)	Waste containing more than 3,700 becquerels (100 nanocuries ) of alpha-emitting transuranic isotopes per gram of waste, half-lives greater than 20 years, except for: (1) HLW, (2) waste the Secretary of Energy has determined, with the concurrence of the Administrator of the EPA, does not need the degree of isolation required by the 40 CFR Part 191 disposal regulations; or (3) waste NRC has approved for disposal on a case-by-case basis in accordance with 10 CFR Part 61.
Mixed Waste	Radioactive waste that is also chemically hazardous, as defined by RCRA, is considered mixed-waste and must meet EPA requirements prior to disposal.
Low-level Waste (LLW)	All other radioactive waste that is not HLW, SNF, TRU waste by-product material (as defined in section 11(e).2 of the Atomic Energy Act of 1954, as amended), or naturally occurring radioactive material.
11(e).2 By product Material	The tailings or wastes produced by the extraction or concentration of uranium or thorium from any ore processed primarily for its source material content.
CIVILIAN WASTE	
WASTE CLASS	DESCRIPTION
HLW	Highly radioactive waste material resulting from the reprocessing of SNF, including liquid waste produced directly in reprocessing and any solid material derived from such liquid waste containing fission products in sufficient concentrations; and other highly radioactive materials the NRC, consistent with existing law, determines by rule requires permanent isolation.
Class A LLW	The physical form and characteristics must meet the minimum requirements of 10 CFR 61.56
Class B LLW	Waste that must meet more rigorous requirements on waste form than class A waste to ensure stability
Class C LLW	Waste that not only must meet more rigorous requirements on waste form than class B waste to ensure stability but also requires additional measures at the disposal facility to protect against inadvertent intrusion
Greater than Class C LLW	LLW not generally acceptable for near-surface disposal
11(e).2 By product Material	The tailings or wastes produced by the extraction or concentration of uranium or thorium from any ore processed primarily for its source material content, including discrete surface wastes resulting from uranium solution extraction process. Underground ore bodies depleted by such solution extraction operations do not constitute "by-product material" within this definition.
* USA Third National Report for the Joint Convention on the Safety of Spent Fuel Management and the Safety of Radioactive Waste Management DOE/EM-0654, Rev 2 October 2008	

closed fuel cycle would generate many more orphan wastes with no disposal options—even if the proposed YM repository was available.

Other countries have adopted a different strategy. Radioactive wastes are categorized by what is in the waste—not where it came from, who generated it, or its history. If a new technology generates a new waste, the composition of the waste is used to determine its category and the disposal requirements. Disposal facilities are built and licensed for all the wastes in a particular category. Sweden has built such a waste management system for all wastes from a once-through fuel cycle. France has partly built such a waste management system for all wastes from a partly closed fuel cycle. The defining characteristics in both systems is that there a waste classification system that categorizes all wastes and well defined pathways for disposal of all materials in each category.

**Table 5.2. International Waste Classification system recommended by IAEA\***

Very Low-Level Waste	Waste that has very low radiological hazards (1-100 Bq/g) and may be disposed at a facility that does not require a nuclear license. It is primarily generated in large volumes from decommissioning activities. No disposal distinction is made based on waste decay time
Low-Level Waste	Waste with low radioactive content (100-100,000 Bq/g). Wastes with short-lived radionuclides are primarily large volumes of contaminated paper, plastic and scrap metal. Long-lived materials are wastes from mining and milling operations of uranium and other ores that contain naturally occurring radioactive materials. Disposal methods are tailored based on half lives.
Intermediate Level Waste	Waste with a higher radioactive content (100,000-100 MBq/g) than LLW, but whose heat generation does not limit the design of storage or disposal facilities. Waste is generated primarily from operations and maintenances of nuclear facilities. US defined TRU waste is an example of long lived ILW.
High-Level Waste	Waste with a high radioactive content (~10 Billion Bq/g), whose heat generation limits must be accounted when designing of storage or disposal facilities. Waste is mainly SNF and fission-product-containing waste from reprocessing operations that have been immobilized in glass. Disposal requires significant shielding and remote handling operations. Disposal requires a deep geological facility.

\* Nuclear Energy Agency: Organization for Economic Co-operation and Development, Nuclear Energy Outlook 2008

### Waste Classification Recommendations

*We recommend that an integrated risk-informed waste management system be adopted in the U.S. that classifies all wastes according to composition and defines disposal pathways according to risk.* The Nuclear Regulatory Commission should take the lead in developing the appropriate framework because waste classification is central to the safe management of radioactive wastes. However, Congress will ultimately need to provide the authority for implementation of such a framework. Such a framework can build upon U.S. waste classification studies<sup>5,6</sup>, and the experiences of other nations<sup>7</sup>.

### GEOLOGIC DISPOSAL OF LONG-LIVED RADIOACTIVE WASTES

In 1957, the U.S. Atomic Energy Commission asked the U.S. National Academy of Sciences (NAS) to recommend methods for the safe disposal of high-level radioactive wastes. The NAS<sup>8</sup> concluded that deep underground geological disposal of wastes was the preferred method for the disposal of long-lived radioactive wastes—a conclusion supported by later NAS studies and accepted by all major scientific advisory boards worldwide. Independent of the choice of a fuel cycle, long-lived radioactive wastes will be generated and a repository for their disposal will be required.

Today, geologic disposal is considered the preferred option for the disposal of long-lived wastes that must be isolated from the biosphere for protection of human health and the environment. Both radioactive<sup>9</sup> and chemical wastes are disposed of in geological repositories (Table 5.3). The chemical wastes are primarily those containing elements that are toxic, last forever, and can not be destroyed—such as lead, arsenic, and cadmium. The first operating geologic repository was the Herfa Neurode repository for chemical wastes in Germany. Since then, additional geological repositories have opened elsewhere in Europe for chemical wastes. The only operating repository for long-lived radioactive wastes is WIPP in New Mexico. There is no operating repository for the disposal of HLW and SNF.

**Table 5.3 Examples of Operational Geological Repositories**

REPOSITORY	CHEMICAL	RADIOACTIVE
Facility	Herfa Neurode (Germany)	Waste Isolation Pilot Plant (U.S.)
Operational	1975	1999
Capacity	200,000 tons/y	175,570 m <sup>3</sup> (Lifetime)
Hazard Lifetime	Forever	>10,000 years

## Repository Design

The development of geological repositories worldwide in multiple types of geology provides a strong scientific and technical understanding of what is required for the design, construction, and operation of such facilities. Within the United States, the siting, design, licensing, construction, and operation of WIPP provides experience in

repositories for intermediate-level wastes. In parallel, the Yucca Mountain Project was the first major sustained technical effort by the United States to design and license a geological repository for SNF and HLW. Much of the scientific understanding of repositories and the technology that was developed is applicable to any future repository.

There are technical characteristics of geological repositories (See Chapter 5 Appendix) that are important to understand in terms of fuel cycles and policy.

- ❑ Geologic repositories are located several hundred meters underground to protect the disposal site from natural and man-made events (land erosion, glaciation, war).
- ❑ Repository capacities are not limited by volume or mass
- ❑ The primary transport mechanism for radionuclides from the repository to the biosphere is by groundwater and use of that groundwater for drinking or growing food. Local geochemistry determines what radionuclides can be transported by groundwater and thus potentially escape from a repository. In most repository environments, actinides (plutonium, etc.) are not expected to escape from the repository because of their low solubility in groundwater and sorption on rock.
- ❑ In disruptive events (volcanism, human intrusion, etc.) actinides become significant contributors to risk.
- ❑ Peak temperatures in a repository must be limited to avoid degradation of repository performance. Radioactive decay produces heat. To reduce the size and cost of a repository, repository programs store SNF and HLW for 40 to 60 years before disposal to reduce the decay heat. Alternatively, a repository can have active ventilation for several decades while the decay heat decreases.
- ❑ The incentives to burn radionuclides in reactors to improve repository performance are limited.

## Institutional Aspects of Geological Waste Disposal

There have been a few successes and many failures in the siting of repositories. Europe has successfully sited and operates multiple geological repositories for chemical wastes. Finland has sited but not completed a SNF repository with public acceptance of the site. Sweden has two communities that have been competing for a SNF repository in their communities and in June 2009 chose one of those communities to host the repository. France may have a repository site. The United States has successfully sited and now operates WIPP. However, there have been multiple failures.

The United States initiated its repository program in the mid 1950s for the disposal of defense wastes. After a series of failed attempts<sup>10, 11</sup> a major effort was undertaken in 1982 to develop a long-term strategic program to build a repository for SNF and HLW. This effort was supported by the Office of Technology Assessment<sup>12</sup> report that made recommendations on how to site a repository. Its executive summary (including what was put in bold in the original report) defined the challenge.

***“The greatest single obstacle that a successful waste management program must overcome is the severe erosion of public confidence in the Federal Government that past problems have created. Federal credibility is questioned on three main grounds: 1) whether the Federal Government will stick to any waste policy through changes in administration; 2) whether it has the institutional capability to carry out a technically complex and politically sensitive program over a period of decades; and 3) whether it can be trusted to respond adequately to the concerns of States and others who will be affected by the waste management program.*”**

*OTA’s analysis suggests that, if history is not to repeat itself, and the current stalemate on nuclear waste is not to continue, a comprehensive policy is needed that addresses the near-term problems of interim storage as part of an explicit and credible program for dealing with the longer-term problem of developing a final waste isolation system. Such a policy must: 1) adequately address the concerns and win the support of all the major interested parties, and 2) adopt a conservative technical and institutional approach—one that places high priority on avoiding the problems that have repeatedly beset the program in the past.”*

The history of efforts to build a geological repository for SNF and HLW since 1982 validate many of the concerns of OTA. A number of lessons have been learned.

**Waste program continuity is important.** Successful waste programs have long-term continuity in management. In the United States, WIPP had changes in management at the Department of Energy but there was a stable management team at Sandia National Laboratory<sup>13</sup>. The continuity helped provide the trust at the local and state level. The same characteristics are seen in successful foreign programs.

**An appropriate funding mechanism is required that raises the funds and makes those funds available to the repository program when required.** The Nuclear Waste Policy Act authorized that disposal services be specified through contracts between DOE and the nuclear utilities. Customers who use nuclear power pay for the disposal of spent fuel. As of December, 2009, the Nuclear Waste Fund has about \$29 billion. The funding mechanisms to collect funds for the repository program have worked as intended. However, changes in the law resulted in the Nuclear Waste Fund being part of the general federal budget. Congress limited annual appropriations for the repository below the amounts requested to a very small percentage of the waste fund balances.<sup>14</sup> The program has been funding limited. DOE has failed to meet its contractual obligations. As a result, the nuclear utilities have won significant financial judgments. The U.S. waste program does not have a viable mechanism to use collected fees on an appropriate schedule to develop and build a repository.

**Public transparency and major outreach programs are critical.** There are striking differences between the large Swedish<sup>15</sup>, Finnish, and French repository outreach programs and the limited outreach programs of the U.S. repository program. Partly this reflects siting philosophy. Nations with voluntary siting strategies by definition must have major outreach

## Waste Isolation Pilot Plant

The United States is operating a geological repository for defense transuranic wastes near Carlsbad, New Mexico. The existence of WIPP indicates that geological repositories can be sited and built in the United States. The ultimate WIPP waste inventory in terms of long-lived radioactive materials will be 1 to 2% of a SNF repository. The siting, construction, and operation of WIPP was difficult with no assurance of success when it started.\* Several factors explain much of the success in siting and operating this geological repository.

WIPP was a high priority of the U.S. government because the failure to dispose of weapons wastes was becoming a barrier for operations of the nuclear weapons complex—a high priority of the federal government. That priority led the U.S. government to provide compensation for hosting such a facility and power-sharing in the form of an oversight role by the State of New Mexico. State cooperation was also partly influenced by the presence of Los Alamos National Laboratory in New Mexico that had a large inventory of transuranic waste that would be disposed of in WIPP. The City of Carlsbad and the surrounding region wanted WIPP to provide a long-term stable economic basis for the economy. The development of WIPP resulted in other fuel cycle facili-

ties moving to Carlsbad—including a several billion dollar enrichment plant. It has been an engine of local economic development.

The technical team supporting the development of WIPP was competent, given the freedom to develop the repository, and had long-term continuity. This included a standing committee of the National Research Council that provided both a review function and an open forum for the expression of NGO and public concerns.

WIPP was defined as a facility in bedded salt near Carlsbad—not a specific piece of salt. As the investigations proceeded, discoveries about the local geology resulted in the specific site being moved twice (geology is extremely site dependent). This ability to move locally depending upon what the geologists found resulted in both a better facility and ultimately higher credibility.

### Note

\* C. McCutcheon, *Nuclear Reactions: The Politics of Opening a Radioactive Waste Disposal Site*, University of New Mexico Press (2002)

programs whereas in the U.S. the Congress chose the Yucca Mountain site when it passed the Waste Policy Act 1987 and assumed that such programs were not required.

**Compensation and local involvement are important.** A geological repository is a large industrial facility with major impacts. In the United States, the successful siting of WIPP involved a significant compensation package for New Mexico and partial regulatory oversight<sup>16</sup> by the State of New Mexico. Similar compensation packages are components of successful foreign programs. For example, the Swedish program<sup>17</sup> has signed a \$240 million dollar agreement with the two communities that were considered for a final repository to help improve infrastructure and make other investments—although only one community was chosen to host the repository.

In contrast, the U.S. repository program compensation to communities is limited and depends upon yearly Congressional appropriations. The Waste Policy Act<sup>18</sup> allows for \$20 million per year or less than 0.5% of the total estimated inflation-adjusted lifetime cost of the repository. We believe a strong case can be made that the benefits to a local community should at least be comparable to the benefits a community would receive by the construction and operation of an equivalent industrial facility.<sup>19</sup>

**Social science input into the program and technical design is important.** A feature of successful foreign programs is the significant scale of effort to understand public concerns

about repositories. Because of cross cultural differences, the conclusions of these foreign studies are not necessarily translatable to the United States. Nevertheless, the French<sup>20</sup> and Swedish<sup>21</sup> programs have come to some conclusions.

- ❑ Repositories should be designed to enable long-term waste retrievability. The public has major concerns about irrevocable decisions, a dread of radioactivity, and a concern for safety for the first few centuries. These social concerns can be partly addressed by repository designs that explicitly include long-term retrievability of wastes as a societal design requirement to provide confidence.<sup>22</sup>
- ❑ Repositories and the safety case should be understandable.

The U.S. National Academy of Science<sup>23</sup> has recommended a focused social science research program as an integral component of a repository program. However, historically U.S. repository programs have been compliance driven; that is, the repository is acceptable if it meets regulatory requirements. Experience suggests that meeting legal requirements is a necessary but not sufficient condition for a successful repository program.

**Successful repository programs have had strong voluntary components as part of their siting programs.**<sup>24</sup> All of the geological repositories for chemical wastes in Europe, the WIPP repository in New Mexico, and the siting of the SNF/HLW repositories in Finland, Sweden and France involved programs that obtained local approval for the repositories. These successes have led other countries<sup>25, 26</sup> to adopt volunteer siting strategies.

Local acceptance impacts national acceptance of a geological repository. As part of our fuel cycle study, a national opinion poll was commissioned (Chapter 9) to better understand public acceptance dynamics associated with nuclear power, spent nuclear fuel storage, and alternative fuel cycles. The question was asked: “Should the United States complete and use the Yucca Mountain facility to store wastes underground?” The results show that national public acceptance of a repository partly depends upon local acceptance of the repository—a result supported by foreign studies.<sup>27</sup>

There is a caveat with respect to the United States. The structure of the U.S. federal system with a federal government and state governments makes it more difficult to site unwanted facilities in the U.S. than in many other countries. In most countries, if the national government and local community agree, the project goes forward. This is not true in the U.S. There are many localities that would accept a repository. For example, the proposed Yucca Mountain repository is supported by the county government in Nevada but opposed by the state government. The local community sees the benefits but the state government sees an unwanted facility with little benefit to the state as a whole. The successes have occurred when all three levels of government have concurred.

**Successful repository programs manage all long-lived radioactive wastes requiring geological disposal.** The Swedish and French waste programs have responsibility for disposal of all long-lived radioactive wastes in their countries. The U.S. repository program has responsibility for disposal of SNF and HLW—but not the small quantities of other long-lived wastes from the once-through fuel cycle and various industries. The storage of SNF by utilities, the navy, and others is not integrated with respect to the repository requirements for SNF storage.



**Successful repository programs are managed with specialized government or utility organizations with strong waste generator commitment.** Different countries have adopted different models<sup>28, 29</sup> for the management of radioactive wastes: government agencies (U.S.), government-owned corporations, public-private partnerships, and private corporations.<sup>30</sup> The private corporations are owned by the nuclear utilities. At one extreme are Sweden and Finland where the utilities have primary responsibility for managing SNF and other wastes—including the siting, building, and operating of a geological repository. Waste liability is transferred to the state after disposal. At the other extreme is the United States where the Federal government assumes liability for SNF when it leaves the reactor site based on payment of a fee as electricity is generated. The Federal government is responsible for siting, building, and operating of the geological repository. The countries with strong waste generator involvement (Sweden, Finland, and to a lesser degree France) have made more progress and have repository sites with public acceptance. The same is true in the United States where DOE is the waste generator and operator of WIPP.

**Successful waste management programs are adaptive.**<sup>31</sup> The Swedish program developed two repository sites before selecting a single site, developed a wide variety of repository design options, and examined both conventional geological disposal and borehole disposal. The French program is examining three waste management strategies: very long-term storage, conventional geological disposal, and burning of selected actinides to reduce repository inventories of long-lived radionuclides. Both programs have formal and deliberate decision making processes. This strategy (1) provides confidence to the public that a realistic examination of the alternatives has been undertaken before decisions were made and (2) provides backup options if unforeseen problems are identified with any single route to manage wastes. In contrast the U.S. program by law was defined by a rigid path to a repository that included a narrow focus on a single site with a single technology.

**Successful repository programs maintain options until there is high confidence in the selected option.** Different options (Appendix) have different institutional characteristics that provide policy makers with choices and increase the likelihood of success. Some options, such as borehole disposal, may provide alternative methods of geological isolation that can be implemented economically on a small scale—creating an economically viable option for regional repositories. For the United States, there is also the incentive to create options to support national nonproliferation policies. Options such as borehole disposal of SNF may have superior nonproliferation characteristics and be suitable for countries with small nuclear power programs; Consequently, the benefits of such R&D support both domestic waste management and foreign policy objectives such as nonproliferation. *We recommend an R&D program to improve existing repository options and develop alternative options with different technical, economic, geological isolation, and institutional characteristics.*

### Recommendations on the Structure of Repository Programs

There have been many proposals on how to manage the U.S. repository program.<sup>32,33,34</sup> Based on our analysis, we have concluded that the U.S. should create a new organization responsible for the management of long-lived radioactive wastes—independent of the final outcome of the Yucca Mountain Project. However, we have not defined the specific structure of such an organization but rather the necessary functions and characteristics required for waste management based on experience worldwide.

- ❑ *The organization should be responsible for management of all HLW, SNF, and all other radioactive wastes requiring geological disposal.* This would include responsibility for off-utility-site SNF and HLW storage because storage is a required “pretreatment” step before disposal. It would also include greater-than-class-C wastes from utility, scientific, and industrial generators.
- ❑ *The organization must have the mission to create and implement an integrated waste management program that addresses both technical and institutional issues.* The charter must state goals but the organization must be able to develop, change, and implement the repository program. This includes adaptive staging strategies.
- ❑ *The organization should be independent of any other organization and have a single focus.*
- ❑ *The organization should be structured for long-term continuity in management where there is not a changeover in management and directions after each presidential or congressional election.*
- ❑ *The board of directors of the organization should include representatives of major groups with an important stake in waste management.* This includes but is not limited to one or more board members:
  - Who are cabinet members reporting to the President of the United States. This is to provide access, if required, to the decision-making levels of the executive branch of the U.S. government.
  - Representing the utilities—the waste generators.
  - Representing the Public Service Commissions—the state regulatory agencies that approve utility electric rates.
  - Representing the public
- ❑ *The organization should be funded with user fees (like the existing program) but with all funds used for the intended purposes and authority to use those funds.*
- ❑ *In cooperation with the Department of Energy, the organization should investigate alternative waste management options.* There will be areas of common and separate interests because of the different missions. The organization’s goal is safe disposal of U.S. wastes. The DOE interests will be based on responsibilities for defense wastes, nonproliferation, and developing future energy options.
- ❑ *The organization should be a participant in planning and discussions on development and implementation of alternative fuel cycles.*

## **INTEGRATION OF FUEL CYCLES AND WASTE MANAGEMENT**

The United States has not historically integrated development of fuel cycles with waste management. In the cold war the defense programs built separations plants for the recovery of fissile materials and placed the wastes in temporary storage. Decades later disposal facilities such as WIPP were built. The high costs and associated risks associated with the U.S. defense waste cleanup programs are a consequence of not coupling the defense fuel cycle with waste management.

The commercial nuclear power industry initially assumed that it would adopt a closed fuel cycle. Because SNF would be shipped to reprocessing facilities, nuclear power plants were

designed with limited SNF storage capacity. In a closed fuel cycle SNF storage is done at the reprocessing facility to provide an operating inventory of SNF for the reprocessing plant. HLW storage before disposal is done at the reprocessing facilities. This is the model used in France and other countries with partly closed fuel cycles.

When the U.S. switched to the once-through fuel cycle, the waste management requirement to store SNF to allow reductions in decay heat before disposal was not addressed. By law the U.S. government was to begin to accept SNF from utilities by 1998; but federal law prohibited the building of a centralized SNF storage facility at the repository site to age the SNF to reduce radioactive decay heat until after the repository was licensed. The engineering solution to this legal constraint was to design a repository that could be ventilated for 50 years before closure to provide the time for the decay heat to decrease in the SNF. In effect, the proposed YM repository would become an underground SNF storage facility for 50 years after the last SNF is placed in the repository. Only after this cooling period is the decay heat low enough in the waste packages for the facility to become a repository. The constraints on SNF storage were (1) a major factor in the proposed Yucca Mountain design, cost, and performance characteristics and (2) responsible for many of its unique design features—good and bad. Delays in the repository program resulted in utilities developing at-reactor SNF storage systems (Chapter 4).

Some countries have integrated waste management and the fuel cycle. The Swedish repository program concluded that SNF storage was required in their system to reduce SNF decay heat before disposal and in 1985 opened its centralized SNF storage facility. France has developed a parallel system for a partly closed fuel cycle.

### **Repository Options for Integrating Waste Management with the Fuel Cycle**

There are a wider set of options for integrating fuel cycles with waste management than generally recognized with different technical and policy implications. Several examples are described herein to illustrate some of the choices.

#### ***Traditional Repository***

The U.S. has the choice to build repositories for all wastes requiring geological isolation or a repository for intermediate-level (low-heat) wastes and a second repository for high-heat wastes (SNF and HLW). WIPP, the existing U.S. repository designed for intermediate-level low-heat wastes, by law only accepts defense transuranic wastes—the largest category of long-lived low-heat radioactive wastes. The U.S. has small quantities of other intermediate wastes where there is no strategy for disposal and will continue to generate those wastes from defense facilities and the open fuel cycle. There are significant incentives to use WIPP for all such wastes that require geological isolation. This would be a small expansion of WIPP in terms of capacity—but would eliminate many classes of orphan wastes that are difficult to manage. An inquiry of and negotiation with the State of New Mexico is called for.

The performance of geological repositories is partly determined by waste form chemistry. With closed fuel cycles, waste forms can be selected with superior performance in a geological repository. For open fuel cycles the strategy is to develop whatever waste packages and other engineered barriers are necessary for direct disposal of SNF. There may be alternative strategies. For example, fuels might be designed with improved performance of the SNF in a repository environment (Appendix C). Another example could involve partitioning of

SNF to improve repository performance, perhaps by disposing of small amounts of selected actinides or long-lived fission products in deep boreholes.

### *Repository with Multi-Century SNF Retrievability*

We do not know today if LWR SNF is a waste or a valuable resource. There is the option of building repositories for disposal of SNF where the SNF can be credibly retrieved if needed for many centuries. The planned French repository<sup>35</sup> has retrievability of waste as an explicit design goal whereas the Swedish repository design would allow long-term retrievability although it is not a design goal. It is an option that minimizes waste burdens to future generations while maintaining options for future generations.

### *Collocation and Integration of Repositories with Closed Fuel Cycle Facilities*

When the U.S. initially tried to implement a closed fuel cycle in the 1960s and 1970s, there was no repository; thus, the closed fuel-cycle model was created of separate siting of reprocessing, fuel fabrication, and repository facilities. If a repository is sited before adoption of a closed fuel cycle, there is the option (Appendix B) for closed fuel cycles to create a single backend fuel-cycle facility that (1) produces fuel elements for reactors using materials recovered from SNF, and (2) locally disposes of all wastes. Such a facility could potentially reduce closed fuel cycle costs and risks, improve repository performance while eliminating the need for long-term repository safeguards, and mitigate proliferation concerns. Collocating reprocessing and fuel fabrication facilities with the repository would provide thousands of jobs and other benefits to the community and state hosting the repository—a form of compensation.

### *Alternative Waste Isolation Systems*

There is the option of building a traditional repository for most wastes and specialized facilities for difficult to manage wastes. For example, borehole disposal may offer superior waste isolation but with the restriction that it is not suitable for large waste volumes. It could enable economic small regional repositories for SNF. Enhanced isolation could be used for plutonium disposal without recovery to address proliferation concerns, disposal of high-hazard wastes (minor actinides and certain fission products), or disposal of high-heat wastes (<sup>90</sup>Sr/<sup>137</sup>Cs). It is an alternative to selective transmutation of radionuclides.

## **RECOMMENDATIONS**

Based on the above findings, we make the following recommendations.

- ▣ *Waste management must become an integral part of the development of any fuel cycle, including an open fuel cycle. The impact of waste management must be included in cost and risk evaluations of alternative fuel cycles.*
- ▣ *The U.S. should map out and determine in a broad context the costs and risks of alternative options for integrating fuel cycles with waste management as a basis for future decisions. Alternative disposal options should be developed to provide long-term policy options for management of U.S. wastes and to support nonproliferation and other national security interests of the United States.*

## CITATIONS AND NOTES

1. A Handbook for Citizens – The Nuclear Waste Primer- The league of Women Voters Education Fund, July 1993
2. The Nuclear Regulatory Commission definition of HLW in 10CFR63.2 is “High-level radioactive waste or HLW means: (1) The highly radioactive material resulting from the reprocessing of spent nuclear fuel, including liquid waste produced directly in reprocessing and any solid material derived from such liquid waste that contains fission products in sufficient concentrations; (2) Irradiated reactor fuel; and (3) Other highly radioactive material that the Commission, consistent with existing law, determines by rule requires permanent isolation.”
3. U.S. Nuclear Regulatory Commission, Background, Status, and Issues Related to the Regulation of Advanced Spent Nuclear Fuel Recycle Facilities, ACNW&M White Paper, June 2008
4. The Energy Daily, “NRC Ruling on Enrichment Plant Wastes Draws Protest,” Vol. 37, No.51 March 20, 2009
5. Risk and Decisions About Disposition of Transuranic and High-level Radioactive Waste, The National Academic Press Washington, D.C., 2005.
6. Charles W. Powers and David S. Kosson, Making the Case for an Integrated Nuclear Waste Management in the United States: Issues and Options, CRES Vanderbilt University, Nashville Tenn.
7. IAEA Safety Series, Classification of Radioactive Waste, Report No. 111-G-1.1, VIENNA, 1994
8. U.S. National Academy of Science-National Research Council, *Disposal of Radioactive Wastes on Land*, Publication 519 (1957)
9. WIPP is the only operating geological repository for radioactive wastes. There have been multiple pilot plants for radioactive waste geological repositories. Russia injected liquid HLW underground and the U.S. has injected high-activity wastes underground in the form of a cement grout.
10. T. F. Lomenick, *The Siting Record: An Account of the Programs of Federal Agencies and Events That Have Led to the Selection of a Potential Site for a Geologic Repository for High-Level Radioactive Waste*, ORNL/TM-12940 (March 1996)
11. J. S. Walker, *The Road to Yucca Mountain*, University of California Press, 2009
12. Office of Technology Assessment, Congress of the United States, *Managing Commercial High-Level Radioactive Wastes* (1982)
13. C. McCutcheon, *Nuclear Reactions: The Politics of Opening a Radioactive Waste Disposal Site*, University of New Mexico Press (2002)
14. The balances of the fund are only available when appropriated – these appropriations count toward total discretionary appropriations.
15. [http://www.skf.se/templates/SKBPage\\_\\_\\_\\_8738.aspx](http://www.skf.se/templates/SKBPage____8738.aspx)
16. R. B. Stewart, “U.S. Nuclear Waste Law and Policy: Fixing a Bankrupt System”, *New York University Environmental Law Journal*, **17**, 783-825 (2008).
17. [www.skf.se/default\\_\\_\\_\\_24417.aspx](http://www.skf.se/default____24417.aspx)
18. Title I, Subtitle F, Sec. 171(a) (1)
19. R. Ewing, C. Singer, and P. Wilson, *Plan D for Spent Nuclear Fuel*, University of Illinois (2009)
20. [www.irsn.fr/FR/Pages/home.aspx](http://www.irsn.fr/FR/Pages/home.aspx)
21. <http://www.sweden.gov.se/sb/d/574/a/52563>
22. The U.S. Nuclear Regulatory Commission requires wastes be retrievable for 50 years.
23. National Research Council, *One Step at a Time: The Staged Development of Geological Repositories for High-Level Radioactive Wastes*, Washington D.C. (2003)
24. Nuclear Energy Agency, Organization for Economic Cooperation and Development, *Partnering for Long-term Management of Radioactive Wastes: Evolution and Current Practice in Thirteen Countries*, NEA No. 6823 (2010)
25. Nuclear Waste Management Organization (Canada), *Moving Forward Together: Designing the Process for Selecting a Site* (August 2008)
26. *Managing Radioactive Wastes Safely: A Framework for Implementing Geological Disposal*, Presented to Parliament by the Secretary of State for Environment, Food and Rural Affairs, Great Britain (June 2008)
27. France initiated a series of studies on French beliefs and implications for waste management.
28. G. DeRoo, “Institutional and Financial Mechanisms for the Nuclear Back-End: the American Exception,” CEEPR 2010-007, Massachusetts Institute of Technology, 2010
29. United States Nuclear Waste Technical Review Board, *Survey of National Programs for Managing High-Level Radioactive Waste and Spent Nuclear Fuel: A Report to Congress and the Secretary of Energy* (October 2009)

30. There have proposals to establish for-profit repositories. R. Garwin, *The Single Most Important Enabler of a Nuclear Power Renaissance: Allowing Competitive, Commercial, Mined Geological Repositories* (August 26, 2009).
31. U.S. National Research Council, *Rethinking High-Level Radioactive Waste Disposal: A Position Statement of the Board on Radioactive Waste Management* **34** (1990) and *One Step at a Time: The Staged Development of Geological Repositories for High-Level Radioactive Waste* (2003).
32. M. Holt, Nuclear Waste Disposal: Alternatives to Yucca Mountain, Congressional Research Service (February 6, 2009); R. B. Stewart, "U.S. Nuclear Waste Law and Policy: Fixing a Bankrupt System", *New York University Environmental Law Journal*, **17**, 783-825 (2008).
33. U.S. Chamber of Commerce, Institute for 21<sup>st</sup> Century Energy, *Revisiting American's Nuclear Waste Policy*, May 2009
34. R. Ewing, C. Singer, and P. Wilson, *Plan D for Spent Nuclear Fuel*, University of Illinois (2009)
35. ANDRA, Dossier 2006: Andra Research on the Geological Disposal of High-Level Long-Lived Radioactive Wastes: Results and Perspectives, Paris, France (2005)



# Chapter 6 — Analysis of Fuel Cycle Options

## INTRODUCTION

The evolution of the nuclear energy system will depend on future demand for nuclear energy, and the reactor and fuel cycle technologies deployed to meet this demand. As discussed in Chapter 2, there are several options for the nuclear fuel cycle. The simplest cycle, which is applied today in the U.S., relies only on mined uranium as fuel, while advanced cycles rely at least partially on fissile material extracted from the discharged fuel of other reactors. Therefore, the fuel cycle options imply different levels of demand for the uranium resource and for industrial infrastructure for fuel recycling, and result in different amounts of spent fuel and of materials to be disposed of as waste. This chapter presents implications of some of the fuel cycle options for a range of demand scenarios, and the sensitivity of the results to key assumptions and constraints involved in the analysis.

The base case assumes that the nuclear energy capacity grows to 120 MWe in 2020, due in part to power uprates of existing reactors, followed by an annual nuclear energy growth rate of 2.5% from 2020 until the end of this century. Such a growth rate will be higher than the growth rate of nuclear energy production in the last two decades, and will result in an increase in the portion of electricity supplied by nuclear plants given the expected annual growth in electricity of 1 to 1.5%. If annual electricity growth between now and 2050 is at 1.5%, the nuclear share will be about 28% in that year. Thus it reflects an assumption that nuclear energy will be relied upon for part of the carbon emission reduction while meeting future demand for energy. A case of lower growth rate of 1% per year and a case of higher growth rate of 4% after 2020 are also examined.

The fuel cycle options considered include the Once-Through Cycle (OTC) using Light Water Reactors, practiced today in the U.S.. Three advanced fuel cycle schemes are also explored in this study (1) Pu recycling in the form of Mixed Oxides in LWRs (“MOX scheme”), (2) Transuranic (TRU) multi-recycling in fast reactors (FR) designated as Advanced Burner Reactors (ABR) of various fissile conversion ratios from 0 to 1, and (3) TRU recycling in a fast reactor designated as breeder (FBR), of which the fissile conversion ratio is 1.23. The schemes involving recycling of TRU in fast reactors have also assumed uranium recycling. On the other hand, we have restrained the study of the MOX scheme to a “twice-through cycle”, which means that the plutonium extracted from uranium fueled LWRs is recycled only once as MOX in LWRs. In principle, the plutonium can be recycled more than once, although this has not been adopted in practice anywhere.

All power reactors in the United States today are LWRs, which operate as thermal reactors. In a thermal reactor, a large fraction of neutrons exist at thermal neutron energies (below 1eV), and most of the fissions occur due to these neutrons. Fast reactors have a neutron



energy spectrum centered at higher energies than the thermal reactors, and most of their fissions are due to neutrons with energy greater than 1000 eV. Reprocessing and fabrication facilities associated with thermal or fast reactors may be called thermal or fast facilities. Prototype fast reactors have been built in the U.S. and several other countries, but only two large scale semi-commercial reactors were built: the BN-600 in Russia and the Superphoenix in France. A fast-spectrum reactor can be designed to fission transuranics efficiently, and these are referred to as burner reactors. Alternatively a fast reactor can be designed to convert abundant fertile materials (uranium-238 or thorium-232) into fissile fuels (principally plutonium-239 or uranium-233) faster than the fissile fuels are consumed. Such a reactor is called a breeder reactor because it produces more fissile fuel than it consumes.

The analysis is conducted via the MIT developed fuel cycle system simulation code CAFCA [Busquim et al., 2008]. The code tracks the infrastructure involved in the nuclear energy supply, the basic material flows in and out of facilities, the inventories in storage and awaiting waste disposal and the economics of the entire enterprise. It applies several simplifying assumptions, but has been found sufficiently accurate for the level of detail required for a system study [Guerin et al., 2009]. All the advanced fuel cycles considered here are for a one-step switch from the once through cycle to an advanced fuel cycle. However, two-tier scenarios, which include a two-step switch using first the MOX option then the FR option, are also possible and have been explored by Guerin and Kazimi [2009].

**KEY CHARACTERISTICS OF THE FUEL CYCLES**

**Once-Through Fuel Cycle Scheme**

The once-through scheme (denoted OTC) is the fuel cycle currently practiced in the U.S. and is considered as the reference case. In this scheme, UO<sub>2</sub> assemblies are loaded in the thermal spectrum light water cooled reactors, irradiated for a period of a few years, discharged and left in “cooling storage” (typically in reactor pools) for a few years (“minimum cooling time”). Finally, the spent fuel is sent either to interim storage or to a repository.

**Figure 6.1 Once-Through Fuel Cycle Scheme**

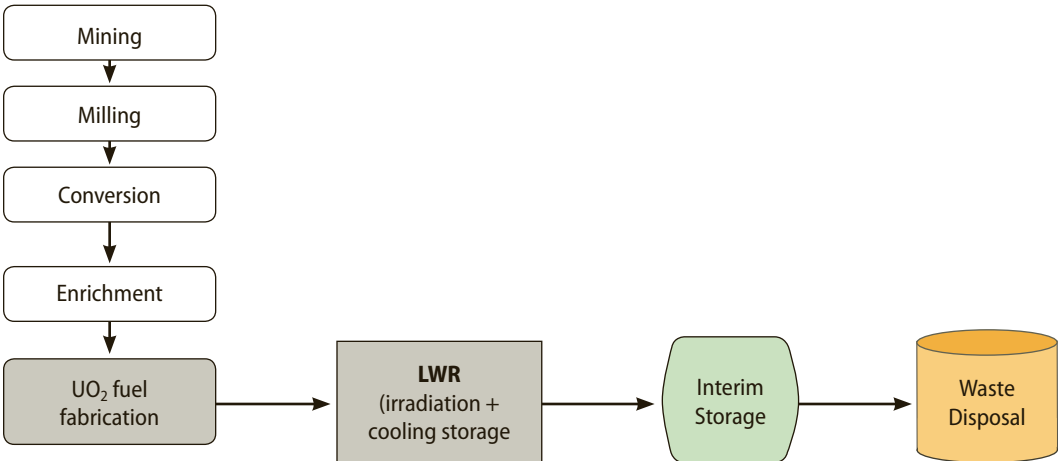

For the sake of simplicity, we use a single model of a reference 1000 MWe LWR, and assume a unique set of parameters for the fuel cycle. Data about the fuel requirements are taken from [Hoffman et al., 2005]. In reality, there are many sizes of LWRs, and their fuel cycles also differ according to their fuel management. Table 6.1 summarizes the characteristics of interest for the reference LWR (scaled to a 1000 MWe unit) as well as all other reactors considered in this study. The sidebar describes the fuel details (fuel compositions, mass flow rates, etc.) used in the analysis.

**Table 6.1 Characteristics of The Reference Power Plants**

PLANT AND CYCLE DESCRIPTION						
	LIGHT WATER REACTORS	FAST BREEDER REACTOR	FAST BURNER REACTOR			
Thermal Power (MWt)	2,966	2,632	2,632			
Thermal efficiency	33.7%	38%	38%			
Electrical Output (MWe)	1000	1000	1,000			
Conversion Ratio	0.6	1.23	0.0	0.5	0.75	1.0
Cycle Length (EFPD) <sup>1</sup>	500	700	132 <sup>2</sup>	221 <sup>2</sup>	232 <sup>2</sup>	370
Average number of batches	3	3 (+ blankets)	8.33	5.82	5.95	3.41
Average irradiation time (EFPD)	1,500	1,785 (2380 for the blankets)	1,099	1,286	1,380	1,262
Discharge Burn up (MWd/kgHM)	50	103.23	293.9	131.9	99.6	73.0

Notes  
1. EFPD: Effective Full Power Days. 2. Fuel Cycle lengths less than about a year are not attractive for utilities, as they require frequent refueling and limit the capacity factor.

### The Twice-Through Fuel Cycle (single pass MOX in thermal reactors)

LWRs may be fueled with Mixed Oxide (MOX) assemblies. MOX is a mixture of Plutonium/Americium<sup>1</sup>oxide (PuO<sub>2</sub>/AmO<sub>2</sub>) and depleted (or natural) uranium oxide (UO<sub>2</sub>). Unlike uranium, plutonium can be found in only trace quantities in nature, but is formed in reactors. About half of the plutonium produced in a LWR is fissioned in that reactor (typically contributing about one fourth of the energy produced over the irradiation of a UO<sub>2</sub> batch), or decays *in situ*. However, a significant amount (typically about 1%<sub>w</sub> of the total heavy metal) remains in the discharged spent UO<sub>2</sub> fuel.

Hence, the twice-through cycle (denoted TTC) is intrinsically a limited recycling scheme. After a minimum cooling time, the fuel discharged from UO<sub>2</sub> fueled LWRs is sent to reprocessing plants where both the uranium (which typically constitutes 99%<sub>w</sub> of the heavy metal in used UO<sub>2</sub> fuel) and the plutonium are extracted. The minor actinides are sent along with the fission products to interim storage for ultimate disposal. The plutonium is sent to MOX fabrication plants (possibly co-located with the reprocessing plant) for MOX pin fabrication. MOX assemblies are then loaded in LWRs for electricity production. Depending on the capability of the reactor and the policy choice, the core can be fully loaded with MOX assemblies, or only partially loaded (typically 30%). In the latter case, the remainder is constituted of traditional UO<sub>2</sub> assemblies. Very few of the existing U.S reactors, so-called Generation II reactors, are licensed to be loaded with MOX assemblies.

## Light Water Reactor Fuel Technical Characteristics

Our fuel cycle analysis used typical LWR operating parameters for the OTC and MOX fuel cycles. The first table shows the average fuel composition, at loading and after 5 years of cooling after discharge. When recycling plutonium as MOX in LWRs, there is a choice of loading all of the MOX into a few

LWRs or loading LWRs with a mixture of  $UO_2$  assemblies and MOX assemblies. We use in this study the data for a typical PWR core loaded with about 30%<sub>w</sub> of MOX, as modeled in [De Roo et al., 2009]. For the MOX cycle both the MOX and  $UO_2$  portions of the fuel are shown.

The isotopic vector of the Pu/Am mix used as a make up feed for the MOX pin fabrication corresponds to typical spent  $UO_2$  fuel with 4.5%<sub>w</sub> initial enrichment, 50 MWd/kgHM discharge burn up, decayed for 5 years in cooling storage. The plutonium is then extracted and decayed over 2 years (transit time in reprocessing plants plus fuel fabrication time). This is slightly inconsistent with the data used for the all- $UO_2$  cores in LWRs (same discharge burnup but a lower (4.23%<sub>w</sub> instead of 4.5%) initial enrichment.

### Average LWR Fuel Compositions for the All $UO_2$ and MOX Cases

COMPOSITION OF FUEL FOR THE ONCE THROUGH AND TWICE THROUGH OPTION (%W OF THE INITIAL HEAVY METAL LOAD)						
	LWR - $UO_2$		LWR - MOX			
	COMPOSITIONS IN %W OF THE INITIAL HEAVY METAL LOAD		FUEL COMPOSITIONS IN %W OF THE INITIAL HEAVY METAL LOAD			
	LOAD	AFTER COOLING	LOAD		AFTER COOLING	
			MOX	$UO_2$	MOX	$UO_2$
U (% <sub>w</sub> $^{235}U$ )	100% (4.23)	93.56% (0.82)	91.27% (DU)	100% (4.5)	88.16%	93.57%
Pu	0	1.15%	8.59%	0	6.00%	1.14%
MA	0	0.13%	0.14%	0	0.70%	0.14%
TRU	0	1.28%	8.73%	0	6.70%	1.28%
FP	0	5.16%	0	0	5.14%	5.15%

### LWR/ $UO_2$ and MOX/ $UO_2$ Fuel Compositions

CORE FUEL MASS AND FLOWS IN LWRS AT CAPACITY FACTOR = 90%								
LWR/ $UO_2$			MOX/ $UO_2$					
CORE MASS AT BOC (MTHM)	87.77							
MASS FLOW (MTHM / GWe / YEAR)								
	LOAD	AFTER COOLING	LOAD			AFTER COOLING		
			MOX	$UO_2$	TOTAL	MOX	$UO_2$	TOTAL
HM	19.500	18.494	5.719	13.667	19.386	5.425	12.964	18.389
U ( $^{235}U$ )	19.500 (0.825)	18.244 (0.150)	5.220	13.667	18.887	5.041	12.788	17.829
Pu	0	0.225	0.491	0	0.491	0.343	0.157	0.500
MA	0	0.025	0.008	0	0	0.040	0.020	0.60
TRU	0	0.250	0.499	0	0.491	0.383	0.177	0.560
FP	0	1.006	0	0	0	0.293	0.703	0.996

### Fuel Compositions for the All $UO_2$ and MOX Cases

The second table summarizes the fuel mass flows for the MOX LWR at a capacity factor of 90% and the resulting residence time of 1,667 calendar days (nearly 4.5 years). In the MOX cycle, the Pu/Am oxide is mixed with depleted uranium oxide (0.25%<sub>w</sub> enrichment). The average discharge burnup is 50.3 MWd/kgHM for both  $UO_2$  and MOX. After discharge, both MOX and  $UO_2$  assemblies are cooled for 5 years.<sup>1</sup> The Table summarizes the amount of fuel in the initial core and in the reload batches of the reactor, annualized to facilitate the simulation.

1. [De Roo et al., 2009]'s calculations actually assumed 7 years of cooling for the MOX spent fuel but we prefer to use 5 years for comparison purposes, while keeping the same data. [NEA, 2009] assumes only 3 years of cooling for spent MOX fuel burnt at 45 MWd/kgHM while [NEA, 2002] assumes 7 years of cooling (including reprocessing) for spent MOX fuel burnt at 50 MWd/kgHM.

Buildup of non-fissile (even numbered) plutonium isotopes and higher actinides with the extended irradiation of plutonium, complicates the handling of the fuel and degrades the nuclear reactivity of the fuel. Thus, plutonium is not thought of as suitable for continuous recycling in *thermal* reactors. In fast reactors, all Pu (and more broadly TRU) isotopes are fissionable. In countries that practice the MOX scheme, the plutonium has been recycled only once, which is also our assumption in this study. However, in some countries the spent MOX fuel is stored until it can be reprocessed to extract its transuranic contents and use them as the fuel to initiate fast reactors. Here, we do not examine that option. Therefore, the spent MOX fuel is sent to interim storage after a minimum cooling time and eventually sent for disposal as fuel assemblies. Readers interested in the case of using the MOX spent fuel to initiate fast reactors will find the analysis in the detailed systems analysis report [Guerin and Kazimi, 2009]. Figure 6.2 shows a representation of the twice-through cycle scheme.

**Figure 6.2 Twice-Through Fuel Cycle Scheme**

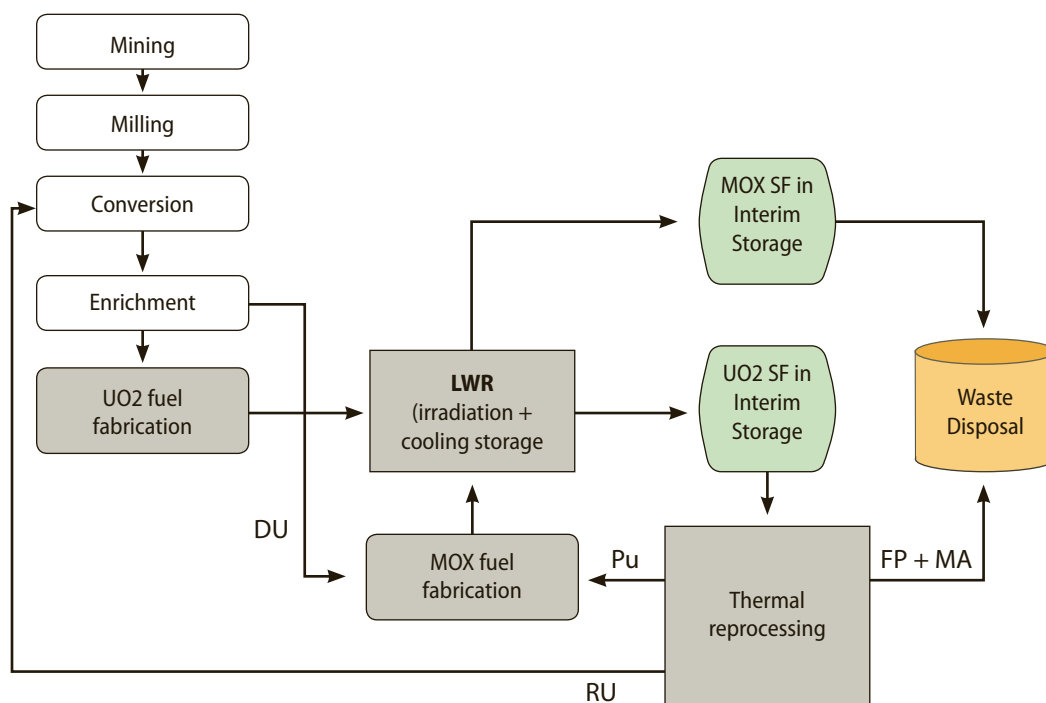

### Fast Reactor Burners

A “fast reactor” is a nuclear reactor in which most fissions occur due to neutrons with energies above 1 keV, while thermal reactor fissions occur mostly by neutrons with energies under 1 eV. At the higher energies, fission cross-sections are smaller, which leads to the need for higher enrichment and higher neutron fluxes in fast reactors. On the other hand, the probability of fission relative to sterile neutron capture is much higher in a fast spectrum for most of the U and TRU isotopes. Hence, burning of plutonium in fast reactors generates fewer higher-mass transuranic isotopes than in thermal reactors. In other words, fast reactors can achieve a relatively more uniform destruction of the TRU isotopes.

When fast reactors are designed to be net consumers of TRUs, they are called “burners” and are characterized by their fissile conversion ratios<sup>2</sup> (CR), which may range from CR=0.0

(fertile-free) to  $CR=1.0$  (break-even, or “self-sustaining”). When fast reactors are designed as net generators of TRU they are called breeders, with a  $CR > 1.0$ .

The fast burner fuel cycle requires reprocessing of the  $UO_2$  fuel discharged from LWRs, after an appropriate cooling time. Transuranics are separated from the fission products in thermal reprocessing plants (uranium is also recovered in the process). These transuranics are mixed with depleted or natural uranium to fabricate fast reactor fuel pins. Fuel assemblies are loaded into fast reactors, irradiated, discharged and decayed over a minimum cooling time. They are then reprocessed in fast reprocessing plants in order to be recycled back into a fast burner. The mixture of uranium and transuranics is separated from fission products (which are sent to disposal) and used to fabricate fresh pins for the fast reactor. Thus, feed materials for fast reactor fuel come from two sources: external supply (TRU separated from LWR spent  $UO_2$  fuel) and self-recycling (U-TRU mix separated from spent FR fuel). As the scheme allows for multi-recycling, it is also known as a closed-fuel cycle: only unusable fission products are eventually sent to disposal. Figure 6.3 shows a representation of the fast reactor fuel cycle, which also applies to the fast breeder scheme (see Section 6.1.4). Mass flows in the fast reactor cores are given in the sidebar.

**Figure 6.3 Fast Reactor Fuel Recycling Scheme**

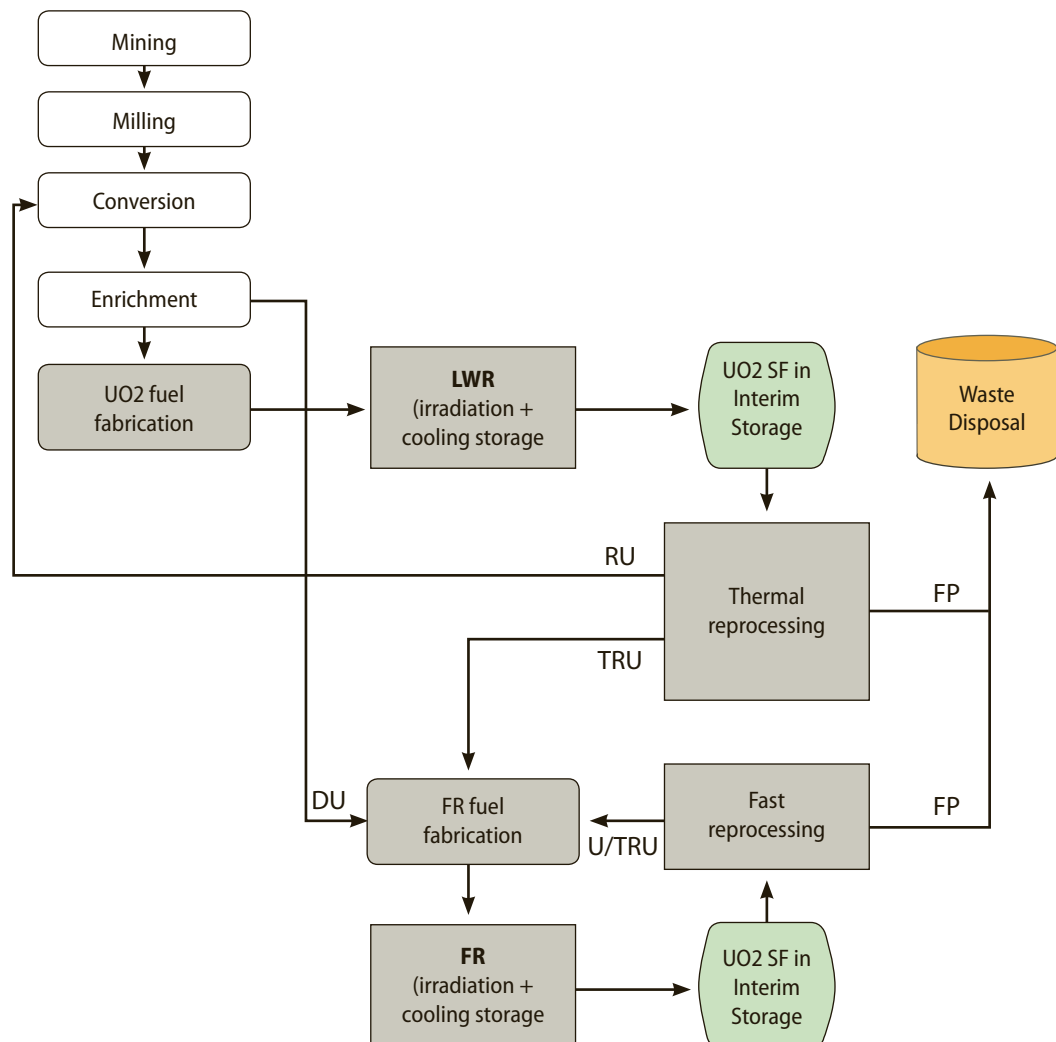

## Fast Breeder Reactors

Unlike a burner fast reactor design, in which limited fertile material is included, a fast breeder reactor requires fertile materials such as  $U^{238}$ , often in blankets surrounding the core, to generate more fuel than it consumes. The blankets are placed in radial and axial positions adjacent to the core. This results in fissile conversion ratios higher than 1.0, therefore often called breeding ratios. However, to compensate for the larger inventory of fertile material in the core and neutron absorption in the blanket, the core may require a higher inventory of fissile isotopes. The core is refueled with transuranics from reprocessing the core and blanket materials. Hence, the TRU mass in the core of a breeder is typically larger than that of a burner core of similar characteristics. However, the fissile material throughput per GWe should be slightly smaller, due to increased buildup of fissile material in the blanket. The past designs of breeder reactors have had a range of fuel inventories per GWe, even when the same fuel material was used [IAEA, 2006].

Having made the distinction of the conversion ratio, the fast breeder fuel cycle scheme is otherwise exactly the same as the fast burner scheme. Differences are quantitative: while a burner (especially of low conversion ratio) will continuously need an external source of TRU (typically from spent LWR fuel) to augment the supply from self-recycling, a fast breeder actually becomes a net source of fissionable materials, as TRU production exceeds its own needs. A representation of the fast reactor fuel cycle is shown on Figure 6.3.

We use as a reference breeder reactor for this study the Advanced Liquid Metal-cooled nuclear Reactor (ALMR), which has a breeding ratio of 1.23 [Quinn et.al. 1993] [Dubberley et.al., 2000]. The ALMR was designed by GE to a greater depth than other metal cooled reactors. Given that the burner reactors used as reference here are metal fueled, it is appropriate to use a metal fuel reactor as the reference breeder. Table 6.1 summarizes the main characteristics of the reactor (scaled up to 1000 MWe from a 319 MWe unit). It is realized that simple size-scaling of the fuel needs would only be an approximation, given the change in surface to volume ratio and implications for neutron leakage from the core. However, such approximations introduce secondary effects that can be tolerated in exploratory system studies. However, a sensitivity case of the fuel requirement effects will be discussed later.

## MODELS AND ASSUMPTIONS OF THE ANALYSIS

The CAFCA code is a materials balance code that tracks the nuclear fuel materials through the various facilities needed to extract, process and burn the fuel in the reactors, then account for the discharged fuel in cooling storage, or longer term interim storage, before it is either sent for disposal in a repository or re-processing to provide some of the needed fuel for reactors. The demand for nuclear energy can be specified in time, and the available nuclear technology can also be specified. In our analysis the LWR is assumed to be available at all times, but reactors that depend on recycling technologies are assumed to become available only at a future time. Here we briefly describe the key assumptions of the analysis. More details are available in Guerin and Kazimi [2009].

All reactors are assumed to have a life-time of 60 years. While the initial license of existing LWRs in the U.S. was issued for 40 years, about 60% of these plants have already received 20 year license extension. It is assumed that the remaining LWRs will also be able to get such a license extension. All new LWRs and fast reactors are assumed to have 60 year operating

license. However, fuel reprocessing plants are assumed to have a lifetime of only 40 years, after which they are retired to allow for new technology to be built.

### Key assumptions about industrial capacity for recycling

The dynamic simulation starts with an initial installed capacity of 100 GWe at the start of 2008, and spent  $UO_2$  fuel inventory of 56,800 tHM. The minimum cooling time is 5 years for all types of discharged fuel.

In the MOX (or TTC) option, the first thermal reprocessing plant starts operation in 2025, and the separated plutonium is immediately used to make MOX fuel. In the options involving fast reactors, the first thermal reprocessing plant starts in 2035, 5 years prior to the introduction of the fast reactors in 2040.

As for the size of the thermal reprocessing plants, a single 1000 tHM/year unit is assumed in all scenarios, this is 25% larger than the most recent plant built in the world (the Rokkasho plant of Japan) but is smaller than the 1700 tHM/yr capacity of the La Hague plant that was built in pieces over several decades. In addition, to make choices that trade off between economies of scale and modularity, we assume different sizes of fast reprocessing units, as suitable for the demand, with the values shown in Table 6.2.

**Table 6.2 Fast Reprocessing Plant Unit Size**

SCENARIO	FR CR=0.0	FR CR=0.5	FR CR=0.75	FR CR=1.0	FR CR=1.2
Fast rep. unit size (tHM/year)	100	200	200	500	500

Another parameter is the industrial capacity to build these processing facilities. The thermal reprocessing plants are assumed to take 4 years to build and license after the need is identified, which means that only one plant can start commercial operation every four years<sup>3</sup>. This industrial capacity is doubled after 2050. As for the fast reprocessing plants, initially (they are available after the year 2040) the industrial capacity is constrained to 2 years/plant, but is doubled after 2065. At that point, it is assumed that the licensing of such facilities become faster than it was when they were first built. Finally, a minimum loading factor of 80% is generally imposed for the reprocessing plants over their life time, meaning that they are only built if a minimum of 80% of their capacity is needed over their lifetime of 40 years. However, some exceptions have been allowed, and will be made explicit.

### Waste management

The notion of waste is not intrinsic; certain materials are designated as waste when they are no longer useful in the cycle, which depends on the particular fuel cycle scenario. CAFCA only tracks the high-level wastes (HLW), indicated by the grey cells in Table 6.3, for the scenarios considered (NA = Not Applicable).

**Table 6.3 HLW in the Fuel Cycle Options**

HLW	SCENARIO			
	ONCE-THROUGH CYCLE	TWICE-THROUGH SCHEME (LWR-MOX)	FAST REACTORS SCHEME (LWR-FR)	TWO-TIER SCHEME (MOX→FR)
Spent UO <sub>2</sub> fuel		NA	NA	NA
FP in spent UO <sub>2</sub> fuel	NA			
MA in spent UO <sub>2</sub> fuel	NA		NA	NA
MOX fuel fabrication losses	NA		NA	
Spent UO <sub>2</sub> /MOX fuel reprocessing losses	NA			
Spent MOX fuel	NA		NA	NA
FR fuel fabrication losses	NA	NA		
FP in spent FR fuel	NA	NA		
FR spent fuel reprocessing losses	NA	NA		
Spent FR fuel	NA	NA	NA	NA

As high-level wastes have various levels of decay heat and radiotoxicity, both varying over time, one cannot simply aggregate their masses to make comparisons among the scenarios. However, “Densification factors” may be used to aggregate the different types of wastes in order to compare the total repository requirements. A densification factor can be defined as [BCG, 2006]: “the quantity of HLW or used fuel that can be disposed per unit length of (disposal drift in) Yucca Mountain is ... referred to as the “drift loading factor” and is expressed in MTHM/m<sub>YM</sub>. ... The densification factor is the ratio of the drift loading factor of HLW to the drift loading factor of used fuel<sup>4</sup>”.

Two potential constraints are considered: volume and heat (taking the waste package into account). In all studies, a total cooling time of 25 years prior to disposal in repository is assumed, and the repository is assumed to be ventilated for 75 years after it is fully loaded. The values of the densification factors are also sensitive to the assumptions about the burnup, the cooling time before reprocessing (e.g the build-up of <sup>241</sup>Am from <sup>241</sup>Pu decay drives up long-term heat) and above all to the amounts of TRU, cesium and strontium remaining in the spent fuel, as shown by Figure 6.4 [Wigeland, 2006]. In this figure, the impact on the repository capacity for waste storage of removal of Cs and Sr as well as transuranic elements (Pu, Am and Cm) is shown. The cumulative densification factor is somewhat correlated with repository costs, as discussed in Chapter 7.<sup>5</sup>

In CAFCA, it is assumed that 99.9%<sub>w</sub> of the Pu or TRU (depending on the scenario) is removed from spent fuel during the reprocessing process<sup>6</sup>. The fission products are assumed to remain in the waste. However, various densification factors can be found in the literature, for both the Pu (or TRU) and fissions Products (FP):

1. The densification factor found in [BCG, 2006] for the FP/MA mix resulting from spent UO<sub>2</sub> fuel reprocessing in the TTC scenario is ~ 4.
2. The [Shropshire et al., 2009] study suggested densification factors from 2 to 10 for the FPs alone (separated from spent UO<sub>2</sub> fuel), with an effective value of 2.5. This value is more pessimistic about the benefit of separations than the [BCG, 2006] estimation. In



**Figure 6.4** Densification Factors as a Function of the Composition of the HLW [Wigeland, 2006]

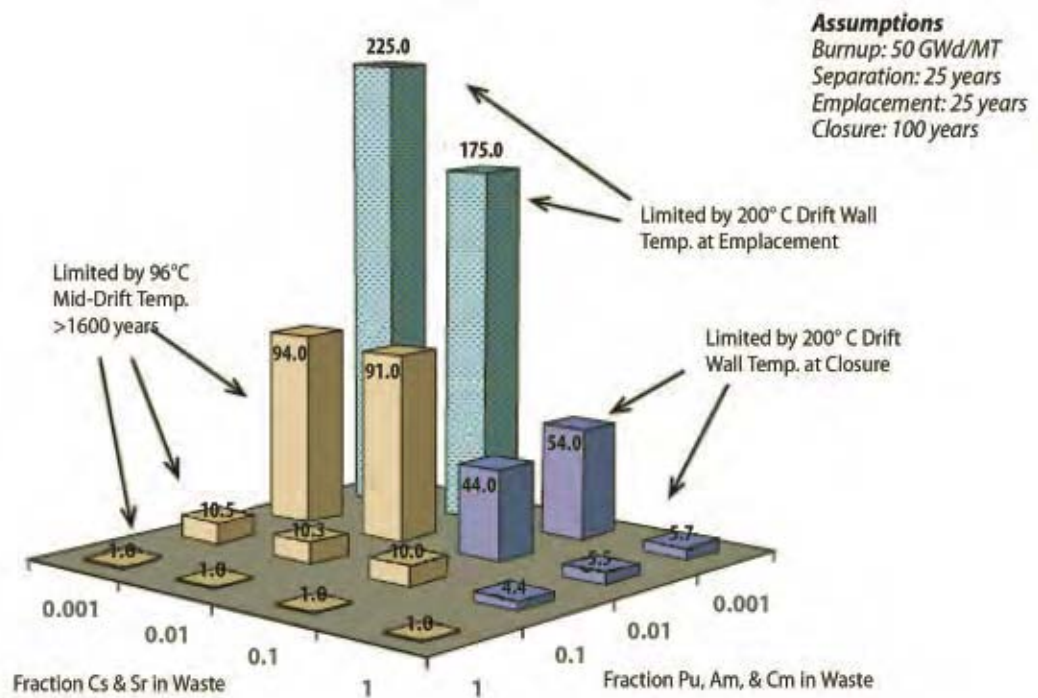

principle, there is little difference between the fission products that are separated from  $UO_2$  spent fuel and those separated from spent MOX and FR fuels.

3. Wigeland and Bauer [2004] found that, with 99.9% removal of plutonium and americium, the densification factor can be between 5 and 6<sup>7</sup>.
4. The densification factor for the spent MOX fuel is ~0.15 [BCG, 2006], reflecting its very high heat content, caused by greater quantities of americium and curium.

Table 6.4 summarizes the densification factors used in our study. Note that the densification factor has a different connotation when it comes to spent MOX fuel. Indeed, in the case of the spent MOX fuel, a densification factor of 0.15 means that 1 kgHM of spent MOX fuel has a larger repository requirement (1/0.15 or 6.7 greater) than 1 kgHM of spent  $UO_2$  fuel. It should be noted that, while the original concept of densification factors was developed in the context of the Yucca Mountain Project, the concept applies to all repositories.

**Table 6.4** Densification Factors for Different Types of Wastes

HLW TYPE	DENSIFICATION FACTOR
Spent $UO_2$ fuel	1
Spent MOX fuel	0.15
FP/MA mix	4
FP	5

## IMPACT OF FUEL CYCLE OPTIONS ON INFRASTRUCTURE

### Reactors

Figure 6.5 shows the total LWR-UO<sub>2</sub> installed capacity in the various fuel cycle schemes for the base case of annual growth of 2.5% per year, while Figure 6.6 shows, for the same schemes, the installed capacity of the advanced reactors involving recycling of discharged fuel from LWRs and/or fast reactors. Recall that the capacity factor of the LWR and that of the FRs differ (90% vs. 85%). Therefore, the total installed capacity may vary from one scheme to another, but the total energy produced per year does not.

**Figure 6.5 LWR-UO<sub>2</sub> Installed Capacity for the Base Growth Case of 2.5% Per Year**

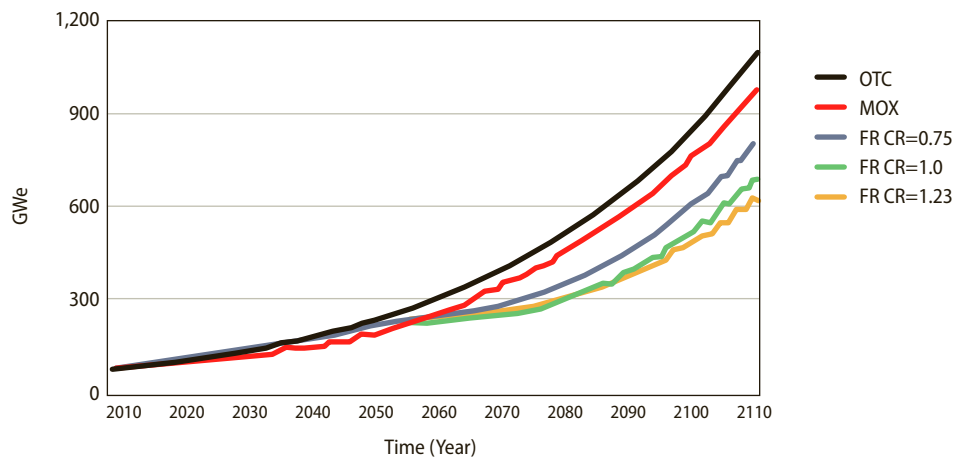

**Figure 6.6 Capacities of Reactors with Recycling Technologies (MOX, FR) for the Base Growth Case of 2.5% Per Year**

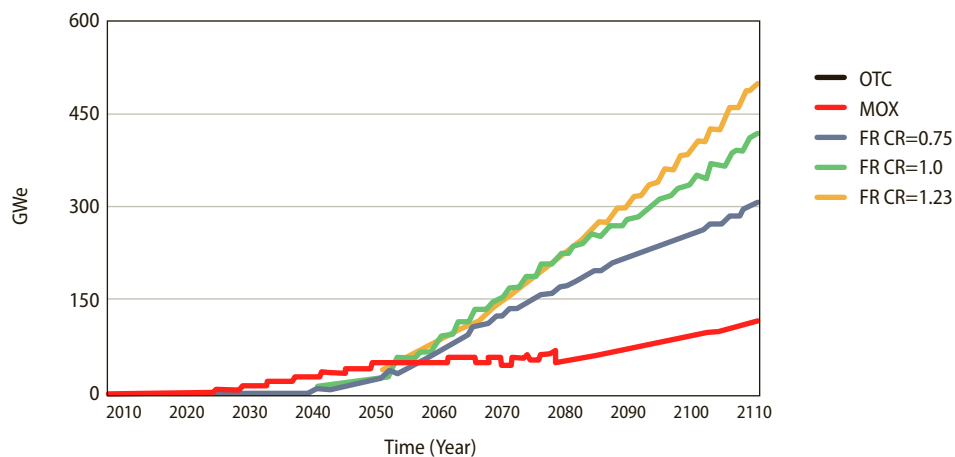

As expected, the breeder installed capacity will over time become greater than that of the other FR options, and those in turn will reach a larger capacity than LWRs-MOX. Table 6.5 shows the installed capacity of each technology for the once through fuel cycle and the four main scenarios in 2050 and 2100 for the three cases of growth rates. It is clear that only in the slow growth scenario would the capacity of fast reactors dominate the nuclear energy supply system by the end of century. In the higher growth scenarios, the LWR will continue to play a major role, providing more than 50% of the nuclear capacity even at the end of the century. This is a result of the traditional assumption that to startup FRs only TRU from LWR spent fuel and FR spent fuel can be used. For a high growth rate, it takes many more LWRs to produce the plutonium needed for startup of the fast reactors.

**Table 6.5 Installed LWR for the OTC, and Advanced Reactor Capacities in the Alternative Schemes in 2050 and 2100 (in GWe)**

GROWTH RATE	FUEL CYCLE	BY 2050	BY 2100
1%	LWR-OTC	166	269
	MOX	41	32
	FR*	20;22; 20	234; 236; 234
2.5%	LWR-OTC	250	859
	MOX	41	91
	FR*	20; 23; 21	259; 345; 391
4.0%	LWR-OTC	376	1,001**
	MOX	41	117
	FR*	20; 23; 21	400; 521; 540

\*Results for CR=0.75, 1.00 and 1.23  
 \*\* The maximum allowed capacity per assumptions in this analysis, reached in 2088

However, it is noticeable that in the base growth case and high growth case, the penetration of a breeder fast reactor at 2100 is close to that of the self-sustaining fast reactor, and both have a significantly higher installed capacity than that of the fast burner. At first glance this appears strange, since the added fissile production in the case of the breeder should enable added FR capacity. However, the fact that the initial core of the breeder reactor requires more fissile material explains the close penetration rate of the FR with unity conversion factor and that of a breeder over this period. The burner and self-sustaining fast reactors minimize the presence of excess fertile material (blankets), whereas the higher breeding ratio reactor needs such blankets. Thus, it needs more fissile loading to compensate for neutron absorption in the blanket.

### Reprocessing plants

Figure 6.7 shows the development of the thermal reprocessing capacities in the various fuel cycle schemes, for the 2.5% growth case. Recall that the unit capacity is 1000 tHM/year and that thermal reprocessing is introduced in 2025 in the MOX scenario vs. 2035 in the FR scenarios. Each facility is assumed to operate for 40 years before being retired. The need for thermal recycling capacity is nearly the same for all schemes until 2070, with somewhat larger capacity needed for the case of a fast burner. However, after 2070, the need for thermal recycling capacity in the case of MOX goes well above the FR cases, due to the exhaustion of the spent fuel in interim storage, and the presence of fissile fuel from reprocessing fast reactor fuel in the FR cases.

As long as no reprocessing is introduced, spent  $UO_2$  fuel discharged from LWRs accumulates in interim storage. A few years after the introduction of the first thermal reprocessing plant, this stockpile reaches a peak, as the reprocessing rate overtakes the inflow rate. In the MOX scenario, the stock of spent  $UO_2$  fuel peaks at 91,000 tHM in 2033 (8 years after introduction of the first reprocessing plant). In the FR scenarios, the peak occurs at 127,000 tHM in 2050 (15 years after the introduction of the first plant).

**Figure 6.7 Thermal Reprocessing Capacity (base case)**

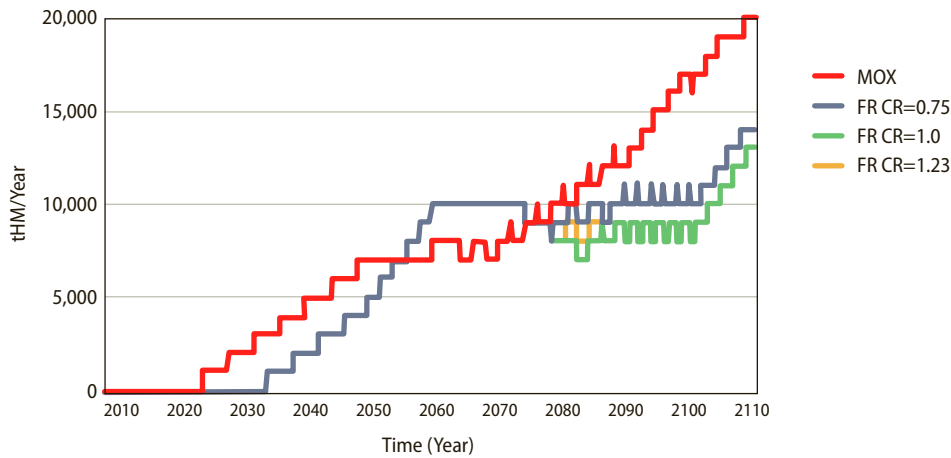

Note that the addition and retirement of a single plant implies a capacity change of 1000 tons/yr, hence the ripples in the curves.

**Figure 6.8 Fast Recycling Capacity for the Base Case of 2.5% Growth**

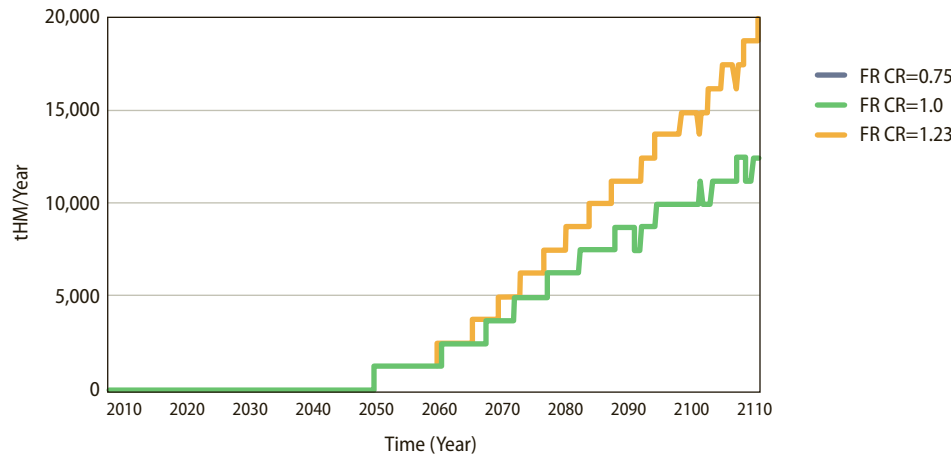

Note that the addition or retirement of a single plant implies a capacity step change of 500 ton/yr.

Figure 6.8 shows the development of fast reprocessing capacity in two cases: The self-sustaining FR with CR=1 and the FR Breeder with CR=1.23. Recall that the unit capacity of a reprocessing facility is 500 tHM/year both of these cases. Also, in both scenarios, the first reprocessing plant starts in 2051, 10 years after the construction of the first FR. By that time enough spent fuel had accumulated to enable the plant to operate above the minimum allowed 80% capacity over its lifetime. The reprocessing capacity needed is much higher in the breeder case than in the self-sustaining case (8,000 tHM/year vs. 5,000 tHM/year in 2110) for two reasons: (1) there are more installed fast reactors (391 vs 345 GWe in 2100) and (2) more significantly, the annual refueling rate of a breeder is larger than that of the self-sustaining case (14.8 vs. 11.2 tHM/year/GWe). However, the TRU content in the discharged fuel is about the same (1.507 vs. 1.571 ton of TRU/year from a 1GWe breeder vs an FR with unity conversion ratio).

### IMPACT ON NATURAL URANIUM REQUIREMENTS AND COST

The introduction of advanced technologies automatically reduces the need for mined natural uranium. The recycling of Pu or TRU from spent fuel as well as the recovered uranium from thermal reprocessing plants, instead of natural uranium, leads to these savings. Table 6.6 shows the cumulative natural uranium utilization for various fuel cycle schemes by the years 2050 and 2100 for the three reference growth rate scenarios. Table 6.7 gives the rate at which mined uranium will be needed in 2050 and 2100 for these cycle options, for the growth rate case of 2.5%.

**Table 6.6 Cumulative Natural Uranium Utilization in Million Tons of U**

GROWTH RATE	FUEL CYCLE	BY 2050	BY 2100
1%	OTC	1.03	2.93
	MOX	0.88	2.34
	FR*	0.98 ; 0.97 ; 0.98	1.77 ; 1.75 ; 1.77
2.5%	OTC	1.26	5.86
	MOX	1.11	4.86
	FR*	1.21 ; 1.21 ; 1.21	4.16 ; 3.78 ; 3.76
4%	OTC	1.56	8.11
	MOX	1.41	6.77
	FR*	1.51 ; 1.50 ; 1.51	5.80 ; 5.34 ; 5.34

\* For fast reactors with conversion ratios of 0.75 ; 1.00 ; 1.23

**Table 6.7 Natural Uranium Utilization Rate (base case of 2.5%) in tons/year**

SCENARIO	DATE	OTC	MOX	FR CR=0.75	FR CR=1.0	FR CR=1.23
Uranium is recycled, after re-enrichment (% difference from OTC)	2050	46,000	35,000 (-23.9%)	40,000 (-13.0%)	40,000 (-13.0%)	40,000 (-13.0%)
	2100	161,000	135,000 (-16.1%)	108,000 (-32.9%)	91,000 (-43.5%)	86,000 (-46.6%)
Uranium is not recycled (% difference from OTC)	2050	46,000	40,000 (-13.0%)	43,000 (-6.5%)	41,000 (-10.9%)	42,000 (-8.7%)
	2100	161,000	148,000 (-8.1%)	117,000 (-27.3%)	100,000 (-37.9%)	95,000 (-41.0%)

The 2100 results are the better indicator of the long-term impact of various fuel cycles, as the system becomes nearer to equilibrium, whereas at 2050 the spent fuel legacy is not depleted yet, providing extra amounts of fissile plutonium and recovered uranium, and the fast reactors are just starting to be deployed.

As seen in Table 6.6 and Figure 6.9, in terms of cumulative uranium savings, for all growth rates, the breeder scenario has nearly the same total U demand as the fast reactors with unity conversion ratio. This is somewhat unexpected given that breeder reactors produce more fissile material than they consume, whereas the CR=1 case reactors produce an amount only equal to what they consume. Upon reflection, it is a logical outcome given that the startup of the breeder reactor requires more TRU than that of the CR=1 case. The net effect is that the total savings of uranium is about equal.

However, the rate of uranium use is diverging, as can be seen in Table 6.7. For the base case of 2.5% annual growth, the breeder fuel cycle yields the best results in the year 2100 in terms of natural uranium savings compared to the once through LWR cycle, reducing its consumption in that year by almost half (46.6%). The burner strategy is less efficient (32.9%) while the MOX strategy only yields very modest results (16.0%, of which half is due to the utilization of recovered uranium). When only TRU is recycled, the reduction in the uranium needed is less than when the discharged uranium is recycled as well.

**Figure 6.9 Cumulative Natural Uranium Consumption (base case)**

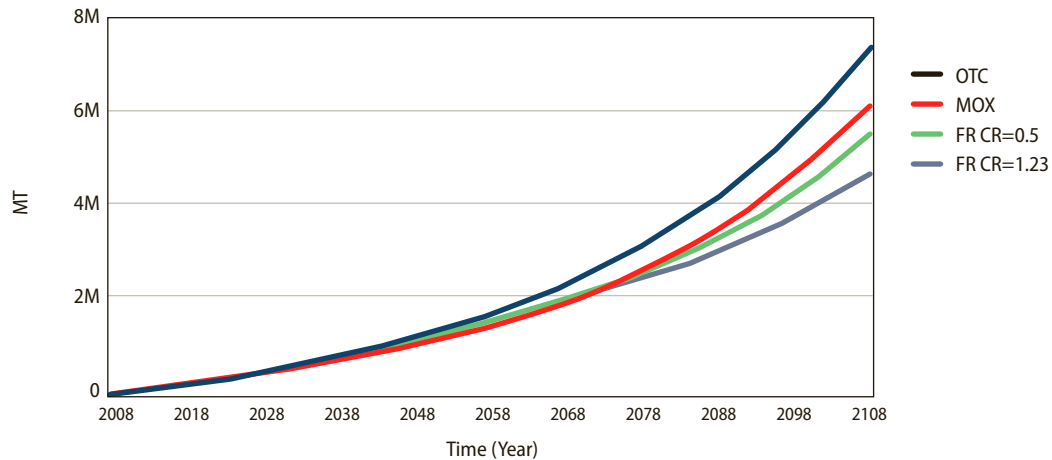

The model developed by Matthews and Driscoll[2009], and described in Chapter 3, can be helpful here to estimate the rise in the cost of uranium at the end of the century<sup>8</sup>. Table 6.8 shows the expected uranium cost for all growth scenarios and fuel cycle options using both the medium (expected) cost case and the pessimistic case. The starting point for the cost in 2008 is \$100/kg, which is close to what the cost is today. It is clear that the cost expected for the medium case at the end of 2100 for the 2.5% growth rate is only 30% higher than what it is today. Given that the cost of U itself is only about 4% of the total fuel cycle cost, this change will be too small to affect the economic competitiveness of nuclear electricity. Even at the largest growth rate and pessimistic cost change case, the U cost may only double by the end of the century. This larger effect is still a relatively small increment in the cost of nuclear electricity.

**Table 6.8 Uranium Cost in \$/kg, Starting With 100 \$/kg in 2008**

GROWTH RATE	FUEL CYCLE	U PRICE MODEL	BY 2050	BY 2100
1%	OTC	medium case	114	125
		pessimistic case	142	180
	MOX	medium case	113	122
		pessimistic case	137	170
	FR*	medium case	114 ; 114 ; 114	119 ; 119 ; 119
		pessimistic case	140 ; 140 ; 140	159 ; 159 ; 159
2.5%	OTC	medium case	116	134
		pessimistic case	148	216
	MOX	medium case	115	131
		pessimistic case	144	205
	FR*	medium case	116 ; 116 ; 116	129 ; 128 ; 128
		pessimistic case	146 ; 146 ; 146	197 ; 192 ; 192
4%	OTC	medium case	118	139
		pessimistic case	155	256
	MOX	medium case	117	136
		pessimistic case	151	224
	FR*	medium case	118 ; 118 ; 118	134 ; 133 ; 133
		pessimistic case	154 ; 154 ; 154	215 ; 210 ; 211

**IMPACT ON ACTINIDE INVENTORIES**

Another key feature of the nuclear fuel cycle is the associated transuranic inventory (either separated or mixed with other products), which can be seen as a source of fuel (MOX, fast reactors) rather than a waste. However, existence of large quantities of TRU in the commercial fuel has been seen by some as potentially posing a proliferation concern. The rationale behind the burning strategies is to reduce the long-term presence of such inventories in the system, while producing energy. If the need for transuranics as a substitute fuel for enriched uranium outweighs proliferation concerns, the breeder option will be preferred.

Figure 6.10 shows for the five main fuel cycle schemes the total amount of TRU in the system, regardless of the TRU location in the system (LWR cores, FR cores, fuel fabrication plants, cooling storages, interim storages, reprocessing plants, wastes). Since TRUs are continuously produced in LWR cores, and the number of these keeps increasing, an upward trend in the total mass of TRU is expected. However, the difference between the once-through and the advanced options is not necessarily intuitive. Indeed, LWRs-UO<sub>2</sub> are net producers of TRU, and deployment of fast reactors reduces the LWR numbers. Therefore, there are two possible trends:

- In the burner schemes: TRU producers (LWR) are replaced by TRU burners (MOX/Fast burners), which moderates the overall growth of the TRU inventory.

**Figure 6.10 Total Amount of TRU in the System (base case)**

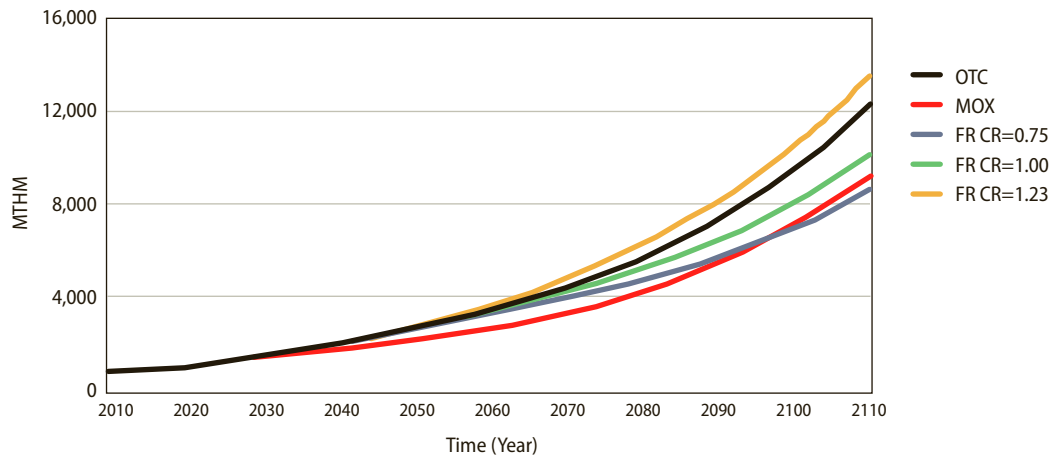

- In the breeder scheme: TRU producers (LWR) are replaced by TRU producers (Fast Breeders), which adds to the overall growth in TRU inventories, and end up with a higher total inventory than the once-through cycle.

As seen in Fig 6.10, starting from a total TRU inventory of 840 tHM (600 tHM in interim storage, 125 tHM in cooling storage, and 115 tHM in LWR cores), the inventory reaches 11,785 tHM in the OTC scenario in the year 2100. However, adoption of the MOX scheme reduces the inventory by a small amount, while the fast burner reactors yield further reduction. The breeder on the other hand ends up increasing the TRU inventory in the entire system slightly above the OTC case.

As can be seen in Figure 6.11 for the self-sufficient fast reactor case at the intermediate growth rate of 2.5%, once the TRU legacy is depleted, the TRU becomes mainly located in the cooling storage (at-reactor pools) and in the reactor cores themselves. To the extent the reactor cores may be considered more secure than interim storage, there is some advantage from a proliferation point of view. Additionally, little TRU is sent to the repository compared to the Once-Through option. However, if at some point in the future the nuclear energy system starts being abandoned in favor of an alternative energy source, the TRU inventory in the entire system will have to be dealt with. Some of it will be used as fuel in the reactors operating at that time. However, a disposal option will be needed at some point in the future, or pure burners will have to be deployed for many decades to reduce the TRU inventory.

### IMPACT ON REPOSITORY NEEDS

Although the recycling options dramatically reduce the total mass of wastes (95%<sub>w</sub> of the spent UO<sub>2</sub> fuel is recovered and recycled), they do not eliminate the necessity of a deep repository, as fission products and unrecoverable TRU amounts (losses) still have to be disposed of. Figure 6.12 shows the total mass of HLW destined to a repository in the various schemes for the base growth case. In the recycling schemes, the assumption of 1% unrecoverable heavy metals is made. Recall that the repository is assumed to open in 2028 and HLW is sent to disposal 25 years after it is generated.



**Figure 6.11 Location of the TRU Inventories**  
(Base Case Growth of 2.5% Per Year and the Self-Sustaining Fast Reactor)

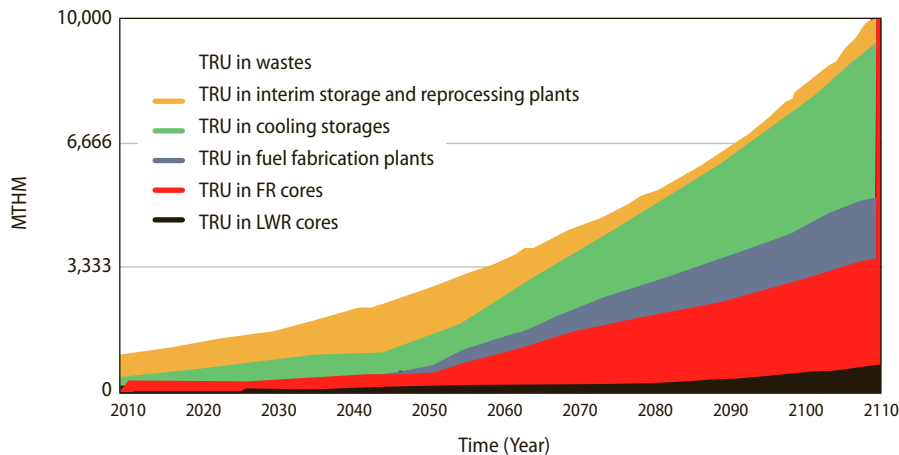

**Figure 6.12 Total Amount of HLW in Repository to Open in 2028 (base case)**

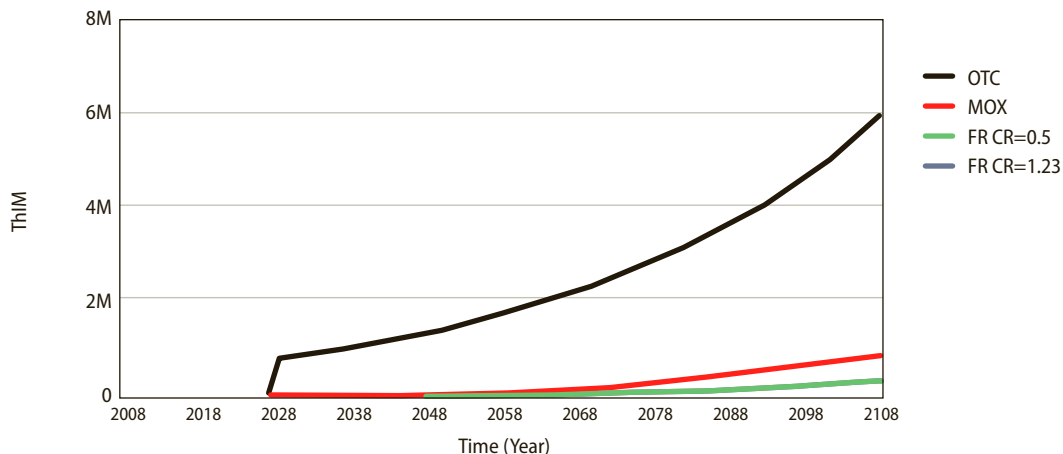

Note: CR = 0.5 line lies on top of CR = 1.23 line

As expected, the OTC generates the largest amount of HLW in terms of mass. The current spent fuel legacy (56,800 tHM) is transferred to the repository in 2028. The accumulation of spent  $\text{UO}_2$  fuel in the repository reaches 444,000 tIHM in 2108. In addition, about two thirds as much as this amount will be waiting in interim storage: 293,000 tIHM in 2108. For comparison, the HLW in the repository rises to only 63,000 tIHM in 2108 in the TTC scenario, plus about two thirds of this amount in interim storage (43,000 tIHM). The HLW amounts in the repository are even smaller for the FR schemes.

However, the mass is not an appropriate metric to compare the different scenarios (see Chapter 5: Waste Management). Wastes vary in decay heat, volume (including packages) and radio-toxicity. Figure 6.13 shows the aggregated amount of wastes using the densification factors given in Table 6.4 as a measure of repository size and cost.

**Figure 6.13 HLW in Repository in YM Equivalent of Spent Fuel (base case)**

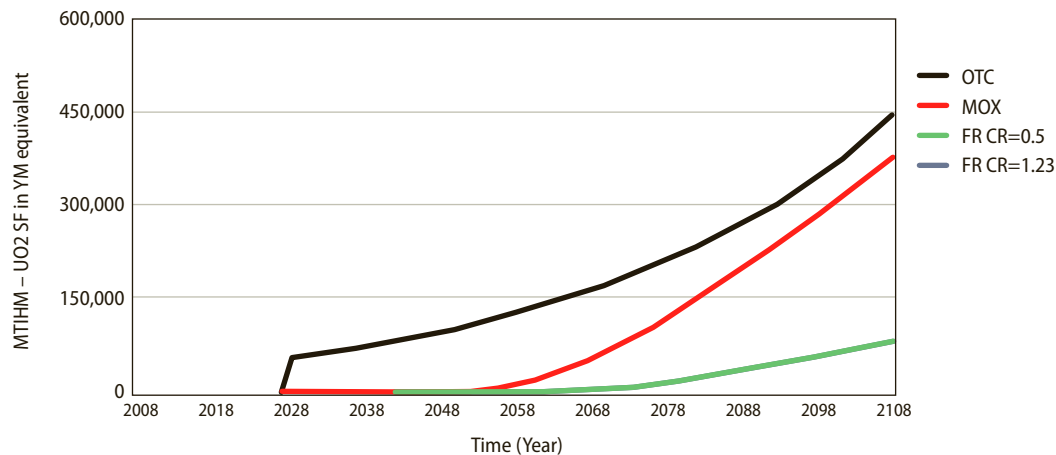

Note: CR = 0.5 line lies on top of CR = 1.23 line

The comparative advantage of the recycling options is reduced when heat generation is considered. In 2108, the repository requirements of the twice-through scenario are equivalent to those of 382,000 tHM of spent  $UO_2$  fuel (or a gain of only 13% with respect to the OTC). In both FR cases, the repository requirements in 2108 are equivalent to 84,000 tHM of spent  $UO_2$  fuel (1.2 YM, or a gain of 81% with respect to the OTC).

Finally, Figure 6.14 shows the amount of TRU in the repository. In the FR scenarios, the 20 tHM of TRU present in wastes in 2100 are diluted in about 38,000 tHM of fission products and therefore do not pose any proliferation concern, until the decay of the fission products. The twice-through scenario reduces the TRU content in wastes, in 2100, by about 35% (4700tHM vs. 7500tHM). Recall that in this scenario the minor actinides are left with the fission products during reprocessing of the spent  $UO_2$  fuel, and are eventually disposed of in a repository. Therefore, the waste contains dilute amounts of fissile materials associated with high radiation fields, thus posing little proliferation concern.

**Figure 6.14 TRU Content in Wastes (base case)**

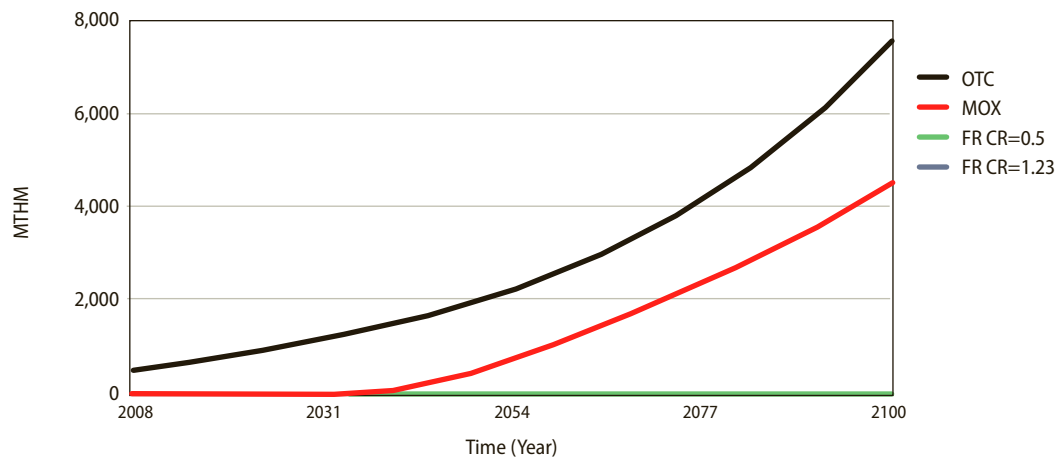

Note: CR = 0.5 line lies on top of CR = 1.23 line

## SENSITIVITY ANALYSIS: ALTERNATIVE ASSUMPTIONS

The impact of variation in the values assumed for some of the key parameters in the analysis of the fuel cycle scenarios presented above has been examined. Results of variation in the important parameters are reported here. The interested reader can get more results in the detailed system study report [Guerin and Kazimi, 2009].

### Sensitivity of fast reactor buildup to the deployment date

The assumption was made in this study that commercial deployment of a fast reactor would start in 2040. However, some might think that this has restricted the share of fast reactor in the nuclear generation capacity to less than 50% throughout the century. Therefore, it is instructive to assess the impact of an earlier deployment rate on the system. Table 6.9 shows the results of introducing the self-sustaining fast reactor in 2025 for the base growth case of 2.5% per year.

**Table 6.9 Effect of Deployment Date on Installed Fast Reactors (CR=1) for the growth case of 2.5% per year [GWe]**

Year of Deployment	By 2050	By 2100
FR CR=1 in 2040	23	345
FR CR=1 in 2025	90	314

It is clear from Table 6.9 that the earlier introduction date impacts the first few decades, allowing more fast reactors in the mix. However, by the end of the century, this early effect is not felt, and the penetration rate might be hurt by the lack of LWRs to produce enough TRU to initiate more fast reactors.

### Sensitivity to time periods of storage and pre-reprocessing

The rate at which fast reactors can penetrate the system is potentially impacted by the minimum cooling time of the spent fuel. As can be seen in Table 6.10 for the case of 2.5% growth rate, if the cooling time needed for the fuel is increased from 5 years to 10 years, the installed capacity of the fast reactor (CR=1) is reduced from 345 GWe to 245 GWe.

**Table 6.10 Installed Fast Reactor (CR=1.0) Capacity for the growth case of 2.5% per year [GWe]**

COOLING TIME	FUEL CYCLE	BY 2050	BY 2100
5 years	FR CR=0.75	20	259
	FR CR=1.0	23	345
	FR CR=1.23	21	391
10 years	FR CR=0.75	20	192
	FR CR=1.0	23	245
	FR CR=1.23	21	274

On the other hand, the introduction date of thermal reprocessing in preparation for the deployment of fast reactors has an appreciable effect in the initial few years after the FR introduction, as can be seen for the year 2050 in Table 6.11. The effect disappears completely by 2070, and the dynamics of TRU availability takes over after that time. Thus the trajectories of the installed FR capacity are close for the two cases examined after 2060.

**Table 6.11 Fast Reactor’s Installed Capacity for the cCse of 2.5% Growth [GWe]**

THERMAL REPROCESSING STARTING YEAR	FUEL CYCLE	BY 2050	BY 2100
2030	FR CR=0.75	28	248
	FR CR=1.0	32	337
	FR CR=1.23	31	387
2035	FR CR=0.75	20	259
	FR CR=1.0	23	345
	FR CR=1.23	21	391

### Sensitivity to initial core fuel requirements

Since the fuel requirements for the fast reactor breeder were extrapolated from the smaller design of the ALMR, it is important to assess the effect of possible improvements (i.e. savings in fuel requirements). Two simulation cases were run for an assumed fuel-saving fast breeder reactor. The new cases with reduced fuel requirements were assumed to require only half as much as the difference between the ALMR and the CR=1 cases in the side bar on fast reactors. In the base cases described in the sidebar, a breeder reactor takes 8.64 MT TRU to start as opposed to 6.31MT TRU for the CR=1 case. The total heavy metal in the startup core is 97.31 MTHM instead of 45.5 MTHM in the CR=1 case. The reduced fuel requirements assumed for the sensitivity study are: the breeder needs only 7.47 MT of TRU in the initial core and only 72 MTHM in the core and blanket. With these assumed requirements, two cases were run, one keeping the breeding ratio at 1.23, and one assuming a smaller breeding ratio of only 1.115. Table 6.12 shows the resulting installed fast reactor capacities in 2050 and 2100 for the base growth case of 2.5% per year.

**Table 6.12 Effect of TRU Requirements on Fast Reactor Installed Capacity For the growth case of 2.5% per year [GWe]**

CONVERSION RATIO	BY 2050	BY 2100
FR CR=1	23	345
FR CR=1.23	21	391
FR CR=1.23*	25	477
FR CR=1.115*	25	408

\*Breeder cases with reduced fuel requirements

It is clear from the table that by 2050 there would be little change in the installed capacity. However, by 2100 the installed capacity will increase if the core with reduced requirements was able to keep the same conversion ratio of 1.23, from 391 to 477 GWe, an increase of 22%. On the other hand, if the reduced fuel requirements led to a decrease in the conver-

## Fast Reactor Technical Characteristics

We use for this study the Advanced Burner Reactor (ABR) designs developed by [Hoffman et al., 2006]. These sodium-cooled reactor core designs achieve low conversion ratio by eliminating the presence of fertile materials including blankets, and achieve different values of CR by changing the amount of inert components in the fuel material. They are mostly reactor physics studies, and none has been sufficiently developed into a practical design. Moreover, safety analysis for the burner reactors has not been fully performed to date. Nevertheless, these core models have generated representative fuel cycle mass flows for systems studies of fast burners as part of the DOE advanced fuel cycle programs. They are also adopted here for similar purposes.

The designs considered in this study are for metal fueled cores with conversion ratios from breakeven (CR=1.0)

to fertile-free (CR=0.0), including the intermediates CR=0.75 and CR=0.5. The plant characteristics are scaled up to reflect a reactor capacity of 1000 MWe, as shown in Table 6.1.

The fuel composition and material flow data used are those for the equilibrium system, in which the U-TRU mix extracted from the spent FR fuel was recycled back into the reactor, together with makeup TRU that was recovered from the spent LWR UO<sub>2</sub> fuel, itself irradiated to 50 MWd/kgHM and stored for five years prior to re-processing. The makeup uranium was assumed to be depleted uranium. The make up amount from external sources decreases with a higher FR conversion ratio. The table gives some characteristics of the FR cycles. All four designs considered that were for 969 MWt plants are scaled for 1000 MWe plants, assuming a thermal efficiency of 0.38.

The second table summarizes the compositions of the FR fuel assemblies for various conversion ratios. One can see that the required fissile concentration increases as the conversion ratio decreases. After discharge, the spent FR fuel was cooled over 297 days in the Hoffman study. For comparison purposes in our study, the minimum cooling time is assumed to be 5 years,<sup>1</sup> while keeping the same fuel composition data.

A capacity factor of 0.85 was assumed, as most of the burner FRs have a shorter fuel cycle than LWRs. In addition, this advanced technology may encounter a period of operation shutdown before matching the LWR record of 90% capacity factor, which took over 30 years to establish. The table summarizes the resulting final mass flows (linearly scaled up from [Hoffman et al., 2006] to obtain a 1000 MWe reactor).

### Fuel Requirements for the Fast Reactor Cases

CORE FUEL MASS AND FLOWS FOR FAST REACTORS AT CAPACITY FACTOR = 85%

	FAST BREEDER REACTOR		FAST BURNER REACTOR				
	Conversion ratio		0.0	0.5	0.75	1.0	
Core Mass at BOC (MTHM)	97.13		9.84	25.66	36.47	45.50	
Core TRU at BOC (MTHM)	8.64		9.70	8.55	7.74	6.31	

	MASS FLOW (MTHM/GWE/YEAR)									
	LOAD	AFTER DISCHARGE	LOAD	AFTER COOLING	LOAD	AFTER COOLING	LOAD	AFTER COOLING	LOAD	AFTER COOLING
HM	14.84	14.01	2.780	1.906	6.194	5.324	8.203	7.327	11.19	10.34
TRU	1.287	1.507	2.741	1.866	2.064	1.677	1.740	1.575	1.552	1.571
TRU net destruction kg/GWe/yr		-220		875		387		165		-19
U	13.52	12.47	0.039	0.040	4.130	3.647	6.463	5.752	9.640	8.763
FP	0	0.831	0	0.874	0	0.870	0	0.876	0	0.857
Pu	1.287	1.507								

### Fast Reactor Technical Characteristics (continued)

The spent FR fuel reprocessing and the FR fuel fabrication (including shipping and storage at reactor site) are assumed to take 1 year<sup>2</sup> each.

1 year of cooling before reprocessing; [NEA, 2009] assumes 4 years of cooling before reprocessing; [NEA, 2002] assumes 2 years of cooling, including reprocessing; [de Roo and Parsons, 2009] assumes 5 years of cooling before reprocessing.

processing and 0.5 year of fuel fabrication; [NEA, 2002] assumes 2 years of storage of the fresh fuel (including fabrication); [de Roo and Parsons, 2009] assumes 1 year of reprocessing, 0.5 year of fuel fabrication + 0.5 year of shipping and storage.

#### Notes

1. We deem 5 years to be more realistic. [Bunn et al., 2003] implicitly assumes only

2. [Bunn et al., 2003] also assumes 1 year of reprocessing and 0.5 year of fuel fabrication + 0.5 year of storage of the fresh fuel; [NEA, 2009] assumes only 0.5 year of re-

### FR Metal Fuel Compositions for Various Conversion Ratios (equilibrium cycle)

COMPOSITIONS IN %W OF THE INITIAL HEAVY METAL LOAD										
Conversion Ratio	FAST REACTOR BREEDER		FAST BURNER REACTOR							
	1.23		0.0		0.5		0.75		1.0	
	LOAD	AFTER DISCHARGE	LOAD	AFTER COOLING	LOAD	AFTER COOLING	LOAD	AFTER COOLING	LOAD	AFTER COOLING
TRU	8.90	10.38	98.59	67.13	33.32	27.07	21.21	19.20	13.86	14.04
U	91.10	84.03	1.41	1.44	66.68	58.88	78.79	70.12	86.14	78.30
FP	0	5.60	0	31.43	0	14.05	0	10.68	0	7.66
Pu	8.67	10.15								
MA	0.23	0.23								

sion ratio to 1.115, the installed capacity is only increased by a small amount, less than 5%. Recalling that the total nuclear capacity in 2100 will be about 860 GWe, the share of fast reactors is about 56% with the improved fuel requirements.

### Startup of Fast Reactors with Enriched Uranium

One option to avoid the coupling of fast reactor startup with reprocessing of LWR spent fuel is to start fast reactors with a core of enriched uranium rather than TRU. As can be seen in the preceding results of the nuclear fuel cycle, the availability of TRU from LWRs for the initial fast reactor core places an upper limit on the deployment rate of fast reactors. Alternatively, starting fast reactors with enriched uranium, and multi-recycling of the resulting TRU, may allow building a larger number of fast reactors, which in turn would save uranium resources. If only fast reactor TRU was recycled, this strategy would obviate the need for facilities to recycle LWR TRU.

Many experimental fast reactors were started using medium- and high-enriched uranium, higher than the current limit on commercial reactor enrichment of 20% U-235— the standard dividing enrichment level distinguishing LEU and HEU (weapons useable). Historically it has been assumed that medium-enriched uranium or plutonium was required to start a fast reactor. Core simulations at MIT show suitable performance for a sodium-

cooled fast reactor (SFR) fueled by enriched uranium below 20%, provided the desired conversion ratio stays about one.<sup>9</sup> The reference uranium-initiated SFR design with CR=1.0 achieved a burnup somewhat below 100MWd/kg using 19.5% enriched uranium oxide fuel with a magnesium oxide (MgO) reflector. The same burnup could be achieved using 14% enriched metal fuel and MgO reflector. After reaching the limiting burnup, the core would be discharged and its TRU content recycled to provide fuel for the next irradiation. In principle, the TRU would continue to be recycled and the fast reactor would operate in a self-sustaining fashion.<sup>10</sup>

In order to assess the benefits and drawbacks of starting reactors with enriched uranium, fuel cycle simulations were run using CAFCA. For purposes of the simulation, only the base case growth in nuclear electric capacity is considered, with 2.5% per year from 2020-2100. Fast reactors are still introduced in 2040. Three scenarios are compared: (1) A once-through scenario with only LWRs being built throughout the simulation, and all spent nuclear fuel is eventually sent to a repository. The second scenario, featuring a traditional fast reactor, involves a self-sustaining sodium-cooled reactor (with a conversion ratio of 1.0), fueled initially by spent LWR TRU and recycled fast reactor TRU after that. All spent fuel is cooled for 5 years before it is reprocessed and recycled as fuel. Both LWRs and fast reactors can be built throughout the simulation. For the enriched uranium FR startup case, LWRs are no longer built after 2040, enabling observations about the maximum impact on demand for mined uranium.

Figure 6.15 shows the effective capacity of LWRs operating over time for each of the three scenarios (the installed capacity will be 11% higher). For the enriched uranium startup scenario, LWRs built before 2040 continue to operate for 60-year lifetimes, and then retire. Correspondingly, more fast reactors must be built than in the traditional fast reactor case in order to keep pace with nuclear power demand (see Figure 6.16).

Contrary to expectation, employing enriched uranium in the startup of fast reactors actually enables uranium *savings* compared to the traditional, TRU-fueled fast reactor fuel cycle (see Figure 6.17). This is because using enriched uranium to start FRs allows an early phase-out of light water reactors, which ends up reducing demand for mined uranium.

Initiating fast reactors with enriched uranium will reduce the generation of high level waste compared to the once through fuel cycle. This is because fast reactors, which recycle their own spent fuel, will replace LWRs. Enriched U fast reactors will not, however, reduce the high-level waste burden on the repository to the extent that traditional fast reactors would. Fast reactors fueled with LWR TRU recycle all the TRU in the system, effectively keeping it in reactors rather than sending it to a repository. For the enriched uranium startup scenario, the recycling process losses and all spent nuclear fuel from the era of LWR build end up at the repository.

There may be a slight proliferation risk advantage for the enriched uranium scenario, because the processing of metal TRU fuel from fast reactors could readily be done in batches through pyroprocessing. Some experts believe that avoiding aqueous reprocessing (the only commercial option at present in order to produce FR fuel from spent LWR fuel) would reduce proliferation risks [Bunn, 2007]; However, this is not likely to be very significant.

**Figure 6.15 The LWR Capacity After Introduction of the Uranium-Initiated Fast Reactor and TRU-Initiated Fast Reactor for the Case of 2.5% Growth**

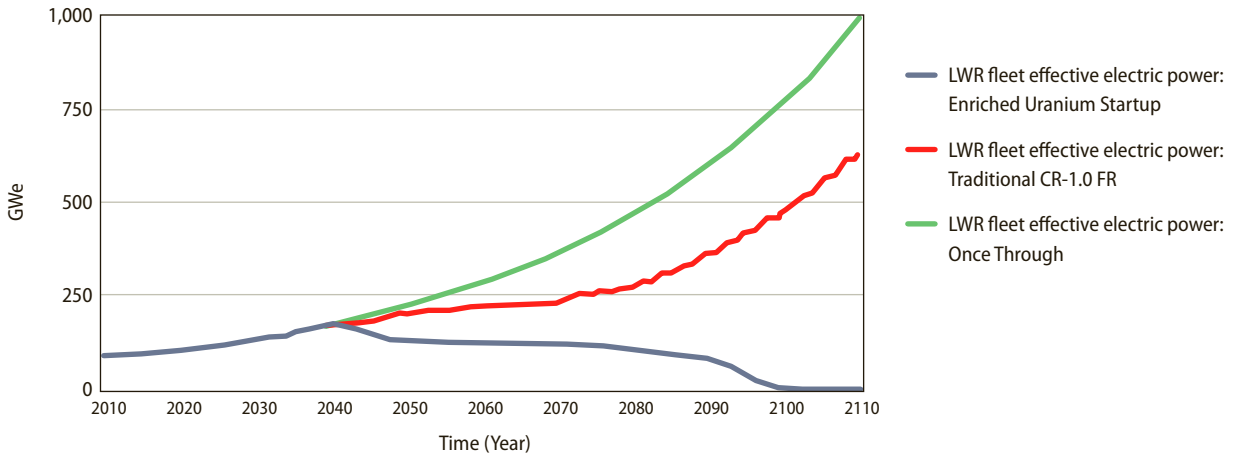

**Figure 6.16 The Fast Reactor Capacity for the Uranium and TRU Initiated Options as well as the OTC Scenario in the Case of 2.5% Growth Rate**

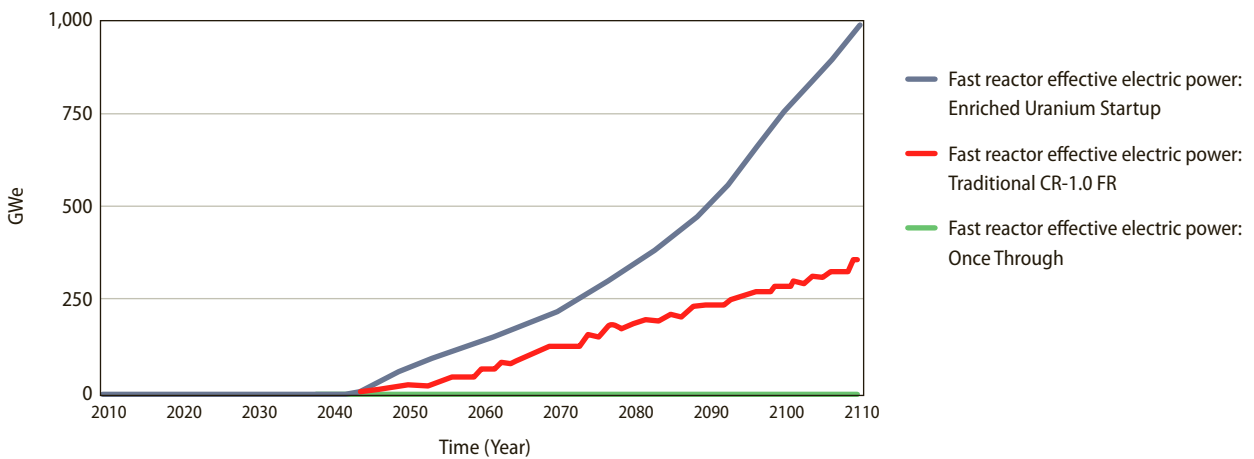

**Figure 6.17 Cumulative Demand for Uranium (in million tons) for the Uranium-Initiated Fast Reactor with CR=1.0 Compared to the Demand for the OTC and the Traditional Plutonium-Initiated Tast Reactor**

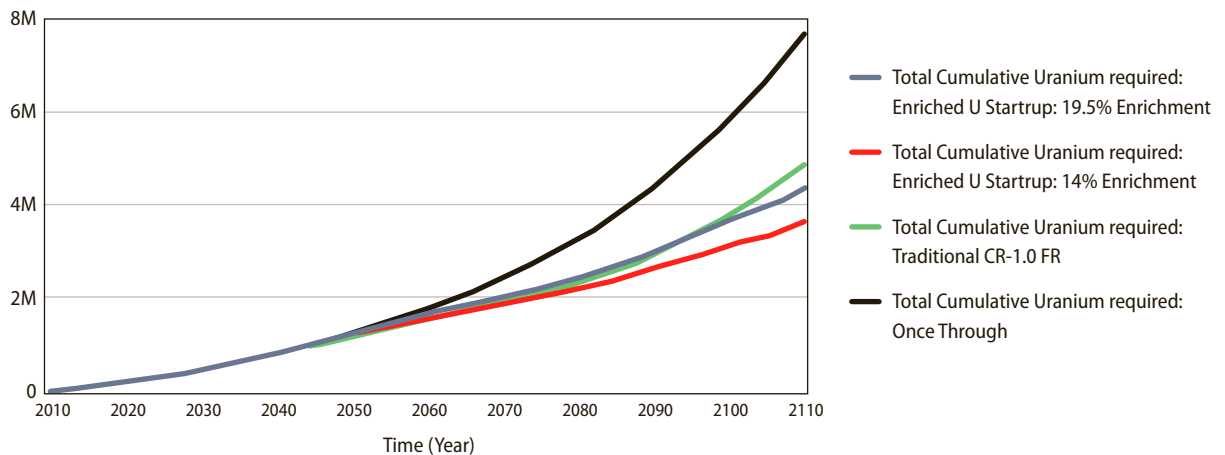



## SUMMARY OF CONCLUSIONS

Among the intriguing results of the dynamic system simulations is that, if the advanced fuel cycles depended for their initial fuel on plutonium or TRU, the share of advanced reactors (including the breeder option) in the total installed capacity is likely to remain less than 50% throughout the century. This is the case despite the accumulated LWR spent fuel that makes available considerable amounts of TRU at the time of introduction of fast reactors. Only for the meekest of growth rates of 1% per year would there be a chance for TRU initiated advanced reactors to provide the majority of nuclear power needed at the end of the century. However, in that case there is little incentive to usher in a recycling scheme that may increase the cost of reactors and their fuel cycle. On the other hand, if the startup of fast reactors depended on enriched uranium, it is possible for the fast reactors to replace the traditional LWR by the end of century.

As a result, at the end of century the effect of introduction of TRU initiated fast reactors on the cumulative natural uranium consumption is below expectations: -35% for the self-sufficient or breeder fast reactor (vs. -24% for the burner and -16% for the MOX) for the nominal case of 2.5% annual growth. These savings have a small effect on the expected availability of low cost uranium. According to the model introduced in chapter 3, using base-case assumptions for uranium demand and availability, the cost which is assumed to be \$100/kg in 2007, ends up at \$128/kg in the fast breeder scenario vs. \$134/kg in the OTC scenario, in constant 2007 dollars. Even in a pessimistic framework about resource availability, the cost escalation remains tolerable at \$192/kg in the breeder scenario vs. \$216/kg in the OTC scenario.

The effect of introducing fast reactors with  $CR=1$  on uranium consumption is nearly equal to that of introducing breeder reactors with  $CR>1$ . But, there are many more reactor technology options (Appendix B) that can achieve  $CR=1$  than  $CR>1$ . There is the potential that some of these reactor options will have significantly lower costs and other advantages over the traditional sodium-cooled fast reactor that can achieve  $CR>1$ . Thus, the choice of the technology of fast reactors should be subjected to a study that considers the advantages of the broader set of options.

All the recycling schemes deplete the spent fuel in interim storage by the end of the 2080s (or 10 years before that in the MOX case) and maintain the stored fuel inventory below 130,000 tHM, well below the OTC scenario level of 600,000 tHM in 2100, for the 2.5% growth scenario. This requires 8,000 to 10,000 tHM/year of thermal reprocessing capacity by 2060. This requirement remains stable in the FR scenarios until the end of the century but must be doubled in the MOX case between 2060 and 2100. Because of the blankets, the fast breeder scenario requires much more fast reprocessing capacity than the burner scenario: 6,000 tHM/year vs. 4,000 tHM/year in 2100 for the base growth case of 2.5% per year.

The breeder ( $CR=1.23$ ) scheme increases the total amount of TRU in the system compared to the OTC. The burner and self sufficient schemes reduce the TRU inventory more than the MOX schemes at the end of the century, compared to the OTC. In the fast reactor schemes, the TRU is mainly located in the reactors, cooling storage, reprocessing plants and fuel fabrication plants, whereas in the MOX scheme, the majority of TRU is contained in the spent MOX fuel, which is considered as waste.

All the recycling options lead to a dramatic reduction in the mass of materials designated as high level wastes compared to the OTC scenario. However, if the heat and volume of the wastes are considered rather than masses (using the appropriate “densification factors”), these reductions would be much more limited.

The impact of variations in the values assumed for some of the key parameters in the analysis of the fuel cycle schemes were studied. In all cases analyzed, only one parameter was changed at a time with respect to the base case. Some notable observations are given below:

- ▣ The transition times between fuel cycles is many decades. Given changes in technology with time, it appears unlikely that any new fuel cycle will reach an equilibrium state. Dynamic simulation of fuel cycles is required to understand the consequences of different technological choices and nuclear power growth rates.
- ▣ Extending the minimum cooling time from 5 years to 10 years for all fuel types reduces the share of fast reactors in the total installed capacity. It limits the availability of TRU to start new fast reactors. By contrast, the extension of the cooling time has a small impact on the MOX scenario.
- ▣ Starting the reprocessing of the spent  $\text{UO}_2$  fuel 10 years, instead of 5 years, prior to the introduction of the fast reactors has a small impact in the short-term (the first fast reactors are commissioned at a higher rate) and almost no impact on the mid-term (25 years later).
- ▣ The use of enriched uranium to start fast reactors with near unity conversion ratio provides a scheme to divorce the speed with which fast reactors can be deployed from the availability of TRU to fuel their initial cores. This facilitates a faster penetration of the nuclear energy system by fast reactors. The lower conversion ratio compared with breeders may also permit a greater range of FR technologies. In addition, such a route to fast reactors avoids the building of a large thermal fuel recycling capacity, which is the costly part of nuclear fuel recycling infrastructure. However, the spent fuel generated by LWRs has to be disposed of in a safe and secure manner, requiring a repository with sufficient capacity.

## REFERENCES

[BCG, 2006] The Boston Consulting Group. *Economics Assessment of Used Nuclear Fuel Management in the United States*, July 2006.

[Bunn et al., 2003] M. Bunn, S. Fetter, J.P. Holdren, B. van derZwann. *The economics of reprocessing vs. direct disposal of spent nuclear fuel*. JFK School of Government, Harvard University, December 2003.

[Bunn 2007] Bunn, Matthew, “Risks of GNEP’s Focus on Near-Term Reprocessing,” testimony for the U.S. Senate Committee on Energy and Natural Resources.

[Busquim et al., 2008] R. Busquim e Silva, M.S. Kazimi and P. Hejzlar. *A System Dynamic Study of the Nuclear Fuel Cycle with Recycling: Options and Outcomes for the U.S. and Brazil*. MIT-NFC-TR-103, MIT, November 2008.

[De Roo and Parsons, 2009] G. deRoo and J. E. Parsons, *The Levelized Cost of Electricity for Alternative Nuclear Fuel Cycles*, a working paper of the Center for Energy and Environmental Policy Studies, MIT, 2009.

[De Roo et al., 2009] G. deRoo, J. Parsons and B. Forget, *Economics of Nuclear Fuel Cycles: Some Real Options and Neutronics Aspects of Recycling*, MIT-NFC-TR-112, MIT, September 2009.

[Dubberley et al., 2000] A.E. Dubberley, C.E. Boardman, K. Yoshida, T. Wu, *Superprism Oxide and Metal Fuel Core Designs*, Proceedings of ICONE 8, 2000.

[Guerin et al., 2009] L. Guerin et al., *A Benchmark Study of Computer Codes for System Analysis of the Nuclear Fuel Cycle*, MIT-NFC-TR-105, MIT, April 2009.

[Gurein and Kazimi, 2009] L. Guérin and M. S. Kazimi, *Impact of Alternative Nuclear Fuel Cycle Options on Infrastructure and Fuel Requirements, Actinide and Waste Inventories, and Economics*, MIT-NFC-TR-111, MIT, September 2009.

- [Hoffman et al., 2006] E.A. Hoffman, W.S. Yang, and R. N. Hill. *Preliminary Core Design Studies for the Advanced Burner Reactor over a Wide Range of Conversion Ratios*, Argonne National Laboratory-Advanced Fuel Cycle Initiative, ANL-AFCl-177. September 2006.
- [Hoffman et al., 2005] E. A. Hoffman, R. N. Hill, and T. A. Taiwo. *Advanced LWR Multi-Recycle Concepts*. Transactions of the American Nuclear Society, vol. 93, November 13-17, 2005, pp. 363-364.
- [IAEA 2006] *Fast Reactor Database: 2006 Update*, IAEA-TECDOC-1531, December 2006.
- [Matthews and Driscoll, 2009] I.A. Matthews and M. J. Driscoll, *A probabilistic Projection of Future Uranium Costs*, Transactions of the American Nuclear Society, MIT, vol 101, Nov. 2009.
- [NEA, 2009] Nuclear Energy Agency, Organization for Economic Co-operation and Development. *Nuclear Fuel Cycle Transition Scenario Studies-Status Report*, NEA/OECD, 2009.
- [NEA, 2002] Nuclear Energy Agency, Organization for Economic Co-operation and Development. *Accelerator-driven Systems (ADS) and Fast Reactors (FR) in Advanced Nuclear Fuel Cycles*, NEA-OECD, 2002.
- [Quinn et al., 1993] J.E. Quinn, P.M. Mahee, M.L. Thompson, T.Wu, *ALMR Fuel Cycle Flexibility*, American Power Conference, 1993.
- [Shropshire et al., 2009] D.E. Shropshire, K.A. Williams, E.A. Hoffman, J.D. Smith, D.J. Hebditch, J.J. Jacobson, J.D. Morton, A.M. Philips, J.P. Taylor. *Advanced Fuel Cycle Economic Analysis of Symbiotic Light-Water Reactor and Fast Burner Reactor Systems*, Idaho National Laboratory, January 2009.
- [Wigeland, 2006] R.A. Wigeland, *Interrelationship of Spent Fuel Processing, Actinide Recycle, and Geological Repository*, Argonne National Laboratory, presented at *International Symposium: Rethinking the Nuclear Fuel Cycle*, held at the Massachusetts Institute of Technology in 2006.
- [Wigeland and Bauer, 2004] R.A. Wigeland and T.H. Bauer. *Repository Benefits of Partitioning and Transmutation*, Argonne National Laboratory, 2004.

## CITATIONS AND NOTES

1. The –undesirable– presence of Americium is due to the decay of Pu-241 into Am-241 (half-life of about 14.4 years).
2. The conversion ratio is defined as the ratio of the rate of production of fissile materials to the rate of destruction of the existing fissile materials, approximated by “the ratio of the macroscopic cross section of U-238 capture to that of TRU fission” [Hoffman et al., 2006]. This last definition neglects secondary sources of fissile materials (e.g. the decay of Pu-240 into Pu-241). Rather than the ratio of instantaneous fissile production and destruction rates, it is more appropriate in the context of this study to define the conversion ratio in terms of integrated amount of fissile material in the discharged fuel divided by the initial loading of a fueling cycle.
3. This includes the construction time.
4. The “used fuel” taken as a reference (densification factor of 1) is spent UO<sub>2</sub> fuel burnt to 50 MWd/kgHM.
5. The [Shropshire et al., 2009] study directly uses the densification factor as a cost ratio.
6. This performance has been obtained only on small-scale extractions so far. Only 99% may be feasible for large-scale facilities; 99.9% is therefore assumed to be a target for the future. Note that the choice between these two assumptions has little impact on the densification factor when Cs and Sr are not removed (5.5 for 99% vs. 5.7 for 99.9% [Wigeland, 2006]). The 99.9% assumption is deemed to be realistic in [NEA, 2002]: “The value of 0.1% for the reprocessing losses is an extrapolation from the current technology to a technology which can be expected to work at a time when transmutation systems could be introduced on a larger scale. The extrapolation is based on expected and partly at laboratory scale proven advances in the wet and dry reprocessing technology. The assumptions are comparable to assumptions which have been made in other national and international transmutation studies”. [Wigeland and Bauer, 2004] makes the same assumption (not including Curium and Neptunium though): “Plutonium and americium are [assumed to be] separated from the spent PWR fuel with an efficiency of 99.9% to address the repository heat load issue”.
7. [Wigeland and Bauer, 2004] also shows that removing cesium and strontium (they would be sent to a short-term separate repository or another facility) would lead to a densification factor of 40-50, but this option is not considered in our scenarios.
8. Note that this model does not address the uranium contained in non-traditional sources, such as phosphates (low production volumes) and in seawater (technology not mature and still too expensive).
9. Ongoing PhD thesis research by Tingzhu Fei supervised by Prof. Michael Driscoll and Visiting Prof. Eugene Shwageraus.
10. The amount of TRU discharged after the initial core may not, in fact, contain sufficient reactivity to sustain the next fast reactor cycle. This has yet to be confirmed. If a reactivity gap exists, it might be filled to some extent by further dropping the initial uranium enrichment (potentially possible with more exotic fuels), thus increasing the breeding ratio of the initial core. Otherwise, other makeup fuels would need to be mixed in with the second-recycle core. The makeup fuels can be small amounts of low enriched uranium.

# Chapter 7 — Economics

## INTRODUCTION

For several decades, the main advantage of recycling nuclear fuel was thought to be economizing on the consumption of raw uranium. The resource was believed to be in short supply, while the demand for nuclear energy was expected to grow dramatically, driving up the price of uranium. The expense of recycling would soon be justified by the savings from avoided purchases of the raw uranium. This vision turned out to be wrong. Uranium proved to be more plentiful than forecasted, and the growth in nuclear power less than forecasted. Moreover, the new fuel and reactor technologies necessary for recycling arrived with more caveats and higher costs than had been expected.

Perhaps one day recycling will justify itself because it economizes on the consumption of raw uranium. Only time will tell. But the current failure of this vision may be salutary if it forces us to broaden our sights and recognize that different fuel cycles entail several other tradeoffs. Some of these tradeoffs are economic, while others are non-economic.

One key economic tradeoff involves the cost of disposal of materials deemed wastes. The critical distinction across the different cycles is in the handling of some of the transuranic elements created in a reactor. Recycling some of these transuranics changes the profile of waste streams over time. In some cases, recycling may lower the discounted cost of disposal, while in other cases it may increase the discounted cost of disposal. The potential economic benefits of an alternative waste stream profile is often overlooked because of the focus on economizing on the consumption of raw uranium. If a fuel cycle is appropriately designed to optimize the ultimate cost of disposal, it could economically justify the extra expense of recycling independently of any benefit from economizing on the consumption of raw uranium. As the results of this chapter show, this is not yet the case with any of the fuel cycles considered in this report. However, future research on fuel cycles should pay closer attention to the economic tradeoff produced by the design of different waste streams.

The non-economic tradeoffs arise on a wide range of issues, including proliferation concerns, health and safety issues as well as waste disposal. Different fuel cycles present different relative advantages and disadvantages with respect to these various issues. Any of these non-economic tradeoffs might justify society's choice of a given fuel cycle, even if that cycle only marginally economized on uranium consumption and required expensive separations or reactors. This chapter focuses exclusively on a comparison of the total cost of different fuel cycles, although cost is only one factor in society's choice of a fuel cycle. Where other factors argue in favor of a fuel cycle that is more expensive, one can think of the extra cost as the price paid to purchase these other benefits.

This chapter reports the cost of the three major fuel cycles discussed in this report: the Once-Through Cycle, a Twice-Through Cycle, and a Fast Reactor Recycle. For the Fast Reactor Recycle the chapter gives results for three different conversion ratios spanning cycles from burner to breeder: these ratios are 0.5, 1.0 and 1.2. The cycles were described in more detail in Chapter 6, and additional information is also given in the Appendix to this Chapter.

The measure of cost applied in this chapter is the levelized cost of electricity (LCOE). The levelized cost takes a full accounting of all costs in a given fuel cycle and allocates them to the electricity produced by the cycle over time. The levelized cost is the constant price that would have to be charged in order to recover all of the costs expended to produce the electricity, including a return on capital. This is a busbar cost that does not include the transmission and distribution costs required to bring the electricity to a particular customer. A formal mathematical definition of LCOE is provided in the Appendix to this chapter. Levelized cost is a standard measure for comparing alternative baseload electricity generating technologies, and employs principles that are standard for comparing alternative technologies in any industry.

Before diving into detailed assumptions and results, two general points should be noted.

## **UNCERTAINTY**

The most important fact to keep in mind in considering any estimate of the cost of alternative fuel cycles is the high degree of uncertainty about key components of each cycle.

First, there is uncertainty about the cost of disposing of the high level wastes from each cycle. While the Once-Through Cycle would seem to be an established technology, the true cost of waste disposal remains uncertain. Political disputes continue to delay the completion and operation of a geologic repository in the U.S. The costs already incurred on construction at Yucca Mountain and the estimates of completion costs under earlier pronouncements on safety standards are a useful guide for estimating waste disposal costs, but not as dispositive as real experience with a fully licensed and operating facility. The cost of disposing of spent MOX fuel is a conjecture unconstrained by actual experience since the countries currently reprocessing and fabricating MOX fuel do not anticipate geologic disposal of the spent MOX, but haven't formalized any alternative disposition. The U.S. had banned reprocessing of spent commercial reactor fuel, and, although the ban has since been lifted there is nevertheless no established regulatory structure for the disposal of the separated high level waste from reprocessing of commercial fuel. Therefore any estimates for the cost of geologic disposal of these wastes must be based on conjectured extrapolations from the standards imposed on unprocessed spent fuel. If the U.S. were to allow reprocessing, the actual regulations might yield a very different waste disposal cost.

Second, there is great uncertainty about the cost of reprocessing spent fuel and the cost of fabricating the recycled fuel. This may be surprising given that the PUREX process for chemically separating plutonium was developed at the dawn of the nuclear age. Nevertheless, only two countries, the French and the British, have built and operated commercial scale plants that extract plutonium from spent reactor fuel, as well as plants for fabricating MOX fuel from the separated plutonium. The Japanese are only now moving to commercial operation their new plant at Rokkasho. Three data points count as a very small number for generating reliable estimates of cost. Moreover, these plants have often been built by state

sponsored entities, and few data are publicly available. The fact that the Japanese plant at Rokkasho has suffered repeated delays in completion, and that the cost is now triple the original estimates, should underscore the size of the uncertainty for this seemingly mature technology. The uncertainty is even greater for other reprocessing technologies, like those under development for fast reactor fuels. These are entirely untested at commercial scale. Any cost estimate for these other processes comes with great uncertainty.

Third, there is enormous uncertainty about the construction and operating costs for fast reactors, which are at the core of many alternative fuel cycles. Almost all fast reactors built to date have been test or demonstration reactors. In a few cases these have included plants that actually provided electricity to the grid, and sometimes at large scale. For example, the Soviet Union's fast reactor program included the BN-350 plant in Kazakhstan and the BN-600 plant in Russia. The former was designed primarily for desalination as well as providing electricity to the grid, and operated between 1972 and 1994. The BN-600 plant, which is still in operation in Russia, was designed to a capacity of 600MW and began operation in 1980. The French Superphénix reactor was designed to a capacity of 1.2 Gigawatts and generated power to the grid between 1985 and 1996, when it was closed. Its operating performance was very poor. Russia is currently constructing another commercial scale fast reactor, the BN-800. The few data that are available for these few examples provides only a very tenuous foundation for estimating costs in a future commercial program.

This large uncertainty about several major cost factors represents an important caveat to any conclusions drawn from the calculations below.

## **COST OF CAPITAL**

A second elusive factor that can play a large role in the economic calculations is the cost of capital.

A cost of capital, or discount rate, is an essential ingredient to any calculation of the cost of alternative fuel cycles. The large capital investments in reactors, reprocessing plants and disposal facilities must be recouped from electricity generated over many years. The levelized cost includes a return on capital invested. A higher cost of capital increases this required return, and a lower cost of capital decreases it. The cost of capital also impacts the relative costs of different fuel cycles. Other things equal, a lower cost of capital improves the ranking of fuel cycles with reprocessing since these tend to involve large, capital intensive operations with paybacks over long horizons.

Advocates for alternative fuel cycles sometimes argue for using an especially low cost of capital to all or parts of the cycle costs. This is justified on the grounds that the reprocessing facilities or the fast reactor will be state owned, and state ownership is thought to imply a lower cost of capital. A variety of arguments are given why state ownership might generate a lower cost of capital. For example, some point to the fact that state entities operate free of certain taxes or levies paid by private companies, thus lowering the rate of return they need to earn to recoup their other costs. Others claim that the state can better bear risk, and so requires a lower return to compensate for the risk. A related argument is that companies operating in a regulated environment face less risk than companies operating in a deregulated environment.

**Table 7.1 Input Parameter Assumptions**

<i>Front-end Fuel Costs</i>		
[1]	Natural Uranium	\$/kgHM 80
[2]	Depleted Uranium	\$/kgHM 10
[3]	Conversion of Natural U	\$/kgHM 10
[4]	Enrichment of Natural U	\$/SWU 160
[5]	Fabrication of UOX from Natural U	\$/kgHM 250
[6]	Conversion of Repr. U	200%
[7]	Enrichment of Repr. U	10%
[8]	Fabrication of UOX from Repr U	7%
[9]	Fabrication of MOX	\$/kgHM 2,400
[10]	Fabrication of FR fuel	\$/kgHM 2,400
<i>Reactor Costs</i>		
[11]	LWR Capital (overnight)	\$/kWe 4,000
[12]	LWR Capacity Factor	85%
[13]	FR Capital premium	20%
[14]	FR O&M premium	20%
[15]	FR Capacity Factor	85%
<i>Reprocessing Cost</i>		
[16]	UOX, PUREX	\$/kgHM 1,600
[17]	UOX, UREX+ or TRUEX	\$/kgHM 1,600
[18]	FR fuel, pyroprocessing	\$/kgHM 3,200
<i>Waste Costs</i>		
[19]	Interim Storage of UOX	\$/kgiHM 200
[20]	Interim Storage of MOX	\$/kgiHM 200
[21]	Disposal of Spent UOX	\$/kgiHM 470
[22]	Disposal of Spent MOX	\$/kgiHM 3,130
[23]	Disposal of HLW from UOX (PUREX)	\$/kgiHM 190 d. factor 2.5 \$/kgFP 3,650
[24]	Disposal of HLW from UOX (TRUEX)	\$/kgiHM 190
[25]	Disposal of HLW from FR	\$/kgiHM 280
[26]	Discount Rate (real)	7.6%

**Notes:**

Figures are in 2007 dollars.

[16]-[18] Reprocessing costs are inclusive of storage, transportation and vitrification.

[21]-[25] Disposal costs are inclusive of transportation and packaging and are quoted as paid at time of unloading, which is five years before being sent to interim storage.

[21] Equal to the 1 mill/kWh statutory fee given our burn-up assumptions. Approx. equal to the historical plus forecasted cost of Yucca Mountain charged on a kWh basis independent of burn-up, using our discount rate. Approximately equal to the 1 mill/kWh statutory fee given our burn-up assumptions and our discount rate.

[22] = [21]/0.15. The 0.15 densification factor applied is based on BCG (2006) figures; approx. equal to \$2,295/\$375. Discrepancy arises due to addition of transportation costs after accounting for the densification factor.

[23] = [24].

[24] = [21]/2.5. The 2.5 densification factor applied is based on Shropshire et al. (2008) and (2009).

[25] = ([24]/5.146%)\*7.8%. I.e., cost is based on the cost of disposal of the HLW from TRUEX measured per kg fission products, multiplied times the quantity of fission products in the fast reactor spent fuel. The 7.8% figure corresponds to a conversion ratio of 1.

[26] 7.6% is the annually compounded rate, r. The equivalent continuously compounded rate, R, is  $R = \ln(1+r) = 7.3\%$ .

We think the application of a lower discount rate based on the claim that some portion of the fuel cycle will be operated by state-owned companies is unsound from a public policy point of view. The fact that certain taxes or other levies are not charged to a state-owned entity is an artifact of the organization of the tax code of a particular country or state, and has nothing to do with the true social cost of the commercial activity making up the nuclear fuel cycle. It is the true social cost that ought to be guiding public policy. Similarly, while certain regulatory structures may lower the amount of risk borne by private investors, thereby reducing the rate of return they need to earn to recoup their investment, this is done by shifting that risk onto ratepayers. The total risk borne by society is not lower due to the regulatory structure, and this total risk is what should matter for a public policy evaluation of alternatives. Most claims that the state can bear risk at a lower cost than industry presume an economy without significant capital markets. Investors in modern developed countries are able to diversify risk to a degree not accounted for in this argument.<sup>1</sup>

The calculations that follow apply a single, commercial cost of capital, one that would be appropriate to private investors operating all aspects of the nuclear fuel cycle in the context of a competitive wholesale electricity market. Even if certain components are owned, managed or operated by government sponsored entities, or if certain parts of the industry operate under cost-of-service regulation, we believe that this is an appropriate basis for the economic comparison of alternative fuel cycles. The cost of capital is meant to reflect the full set of risks borne by society associated with the activities of the fuel cycle, and so

should not be changed to reflect changes in who bears these risks. The use of a lower cost of capital for certain activities artificially lowers the calculated cost and skews the comparison of costs across fuel cycles.

## LEVELIZED COST RESULTS

Table 7.1 lists our key assumptions for the many inputs to the levelized cost calculations for each cycle examined here. The methodology is explained more fully in the Appendix together with a number of other assumptions employed. Full detail on the calculations is available in an on-line research report.<sup>2</sup>

### Once-Through Cycle

Table 7.2 shows the levelized cost for the Once-Through Cycle. The levelized cost is broken down into four main components: the front-end fuel cycle costs, the reactor capital costs, the reactor non-fuel operating and maintenance costs, and the back-end fuel cycle costs. The front-end fuel cycle cost is further broken down into two elements: the cost of the raw uranium and the cost of manufacture, which is defined here to include conversion, enrichment and fabrication. The total levelized cost for the Once-Through Cycle is 83.81 mill/kWh (equivalently 8.381¢/kWh or \$83.81/MWh).<sup>3</sup> Of this, the front-end fuel costs in total account for 8% or 7.11 mill/kWh. The cost of raw uranium is only 2.76 mill/kWh, or 3% of the total levelized cost of electricity, which already makes clear that savings on the purchase of raw uranium, given the input price of uranium, will have little impact on the total cost of electricity. The reactor capital costs account for 81% of the cost, or 67.68 mill/kWh. This is the constant charge for electricity produced by a reactor operating at 85% capacity for 40 years that would just cover the \$4,000/kW overnight cost of building the reactor as well as the maintenance capital expenditures over time and the decommissioning cost. The non-fuel operating and maintenance costs account for another 9% of the cost, or 7.72 mill/kWh. Finally, the back-end fuel cycle cost is 1.30 mill/kWh. This is the fee per unit of electricity produced that would be sufficient to cover the cost of interim above-ground storage of the spent fuel plus the cost of ultimate disposal in a geologic repository.

**Table 7.2 The LCOE for the Once-Through Cycle**

		(MILL/KWH)
[1]	Raw Uranium	2.76
[2]	Fuel Production	4.35
[3]	Front-end Fuel Cycle	7.11
[4]	Capital Charge	67.68
[5]	O&M Costs (non-fuel)	7.72
[6]	Back-end Fuel Cycle	1.30
[7]	LCOE Total	83.81
Notes:		
[3]=[1]+[2].		
[6] incorporates interim storage and ultimate disposal in a geologic repository.		
[7]=[3]+[4]+[5]+[6].		

**Table 7.3 The LCOE for the Twice-Through Cycle**

		(MILL/KWH)
<i>First Pass — UOX Fuel in a LWR</i>		
[1]	Raw Uranium	2.76
[2]	Fuel Production	4.35
[3]	Front-end Fuel Cycle	7.11
[4]	Capital Charge	67.68
[5]	O&M Costs (non-fuel)	7.72
[6]	Reprocessing	2.36
[7]	HLW Disposal	0.40
[8]	Reprocessed Uranium	-0.14
[9]	Plutonium	0.25
[10]	Back-end Fuel Cycle	2.87
[11]	LCOE Total	85.38
<i>Second Pass — MOX Fuel in a LWR</i>		
		(MILL/KWH)
[12]	Depleted Uranium	0.03
[13]	Plutonium	-4.39
[14]	Fuel Production	7.38
[15]	Front-end Fuel Cycle	3.02
[16]	Capital Charge	67.68
[17]	O&M Costs (non-fuel)	7.72
[18]	Back-end Fuel Cycle	6.96
[19]	LCOE Total	85.38
[20]	Price of plutonium, \$/kgHM	-15,734
Notes:		
[3]=[1]+[2].		
[10]=[6]+[7]+[8]+[9].		
[11]=[3]+[4]+[5]+[10].		
[15]=[12]+[13]+[14].		
[18] incorporates interim storage and ultimate disposal of the spent MOX geologic repository.		
[19]=[15]+[16]+[17]+[18].		
[20] is determined to set [11]=[19].		
[20] enters into [9] and [13].		



## Twice-Through Cycle

Table 7.3 shows the levelized cost for the Twice-Through Cycle. In the Twice-Through Cycle raw uranium is first fabricated into uranium-oxide fuel (UOX) for use in a light water reactor. This is called the first pass of the fuel in a reactor. Then the spent fuel is reprocessed, and plutonium, whether in isolation or mixed with uranium, is fabricated into a mixed-oxide fuel (MOX) for reuse in a light water reactor. This is called the second pass of the fuel in a reactor. Of course, the MOX fuel forms only a part of the fuel core of the second reactor. The table shows the levelized cost for both: lines [1]-[11] detail the LCOE for the first pass, the UOX fuel in a light water reactor, while lines [12]-[19] detail the LCOE for the second pass, the MOX fuel in a light water reactor.

For the first pass reactor burning fresh UOX fuel, the front-end fuel costs, reactor costs and non-fuel operating and maintenance costs are identical to those for the Once-Through Cycle—lines [1]-[5]. However, the back-end fuel cycle costs are different since the spent fuel is sent for reprocessing. The costs of reprocessing the spent UOX fuel are included as a part of the back-end fuel cycle cost for the first pass—line [6]. The reprocessing produces three streams: uranium, plutonium and high level waste. The high level waste contains the fission products, minor actinides and impurities. The cost of disposing of this high level waste stream is included as a part of the back-end fuel cycle cost for the first pass—line [7]. A credit for the value of the recovered uranium, which can be used in the fabrication of fresh UOX fuel, is included as a part of the back-end fuel cycle cost for the first pass—line [8]. The size of this credit is determined by the price of raw uranium for which the reprocessed uranium is a substitute, and the differential cost of fabricating UOX from reprocessed uranium. The analysis also requires a credit for the value of the recovered plutonium which will be used to fabricate MOX fuel for the second pass—line [9]. Since the MOX fuel is used to produce electricity that substitutes for electricity produced with UOX fuel, the size of the credit will be such that the LCOE for the first pass and the LCOE for the second pass are exactly equal—i.e., line [11] will equal line [19]. Line [20] shows this credit measured as a price per unit of plutonium, \$ -15,734/kg. Line [9] shows this credit measured as a value per unit of electricity, \$ -0.14 mill/kWh. The fact that the price of the separated plutonium is negative, as is the credit obtained by the first reactor, implies that the first reactor pays for the plutonium to be taken away. The total back-end fuel cycle cost for the first pass is 2.87 mill/kWh—line [10]. This is a much higher cost of disposal than in the Once-Through Cycle.

The total levelized cost for the first pass reactor in the Twice-Through Cycle is 85.38 mill/kWh, which is higher than in the Once-Through Cycle. The difference between the two is entirely due to the higher cost of disposing of the spent fuel by reprocessing as opposed to sending the complete spent fuel package directly to a repository.

For the second pass reactor burning MOX fuel, the front-end fuel cost is composed of the purchase of depleted uranium, a credit for taking the separated plutonium, and the cost of fabricating the MOX fuel. These items are shown in lines [12]-[14] and the total is shown in line [15]. This second pass has a much lower front-end fuel cycle cost than the first pass—3.02 mill/kWh as opposed to 7.11 mill/kWh for the first pass. This is primarily due to the fact that the second pass reactor owner will be paid to take the separated plutonium. The payment equals 4.39 mill/kWh—line [13]—and is a significant help in offsetting the high cost of fabricating the MOX fuel. The levelized reactor capital and operating costs—lines [16] and [17]—are exactly the same whether the reactor is burning UOX fuel or MOX fuel.

The back-end fuel cycle cost for the reactor burning the MOX fuel—line [18]—is 6.96 mill/kWh. This represents the cost of interim above-ground storage and ultimate disposal of the spent MOX fuel in a geologic repository. This is much larger, per unit of electricity, than the cost of disposing of spent UOX (compare line [6] in Table 7.2 against line [18] in Table 7.3), and is worth some additional discussion.

Although there currently exist countries that produce MOX fuel from recycled plutonium, there are no countries that currently dispose of the spent MOX fuel in geologic repositories. Instead, the spent MOX fuel is in interim storage, and the final disposition of the spent MOX fuel remains uncertain. Some imagine that eventually the spent MOX fuel will be recycled again, this time to produce fuel for a system of fast reactors. In order to produce a meaningful levelized cost calculation, some ultimate disposition must be specified. That disposition could either be (a) disposal in a geologic repository, or (b) further recycling. More realistically, the final disposition is uncertain and will depend upon future events. Call this option (c). The LCOE reported in Table 7.3 for the Twice-Through Cycle assumes (a). The analysis below of the LCOE for the Fast Reactor Recycle which is reported in Table 7.4 sheds light on the results that are likely for options (b) and (c). If further recycling is to be done in fast reactors, it would be cheaper to go directly from the spent UOX fuel to a fast reactor fuel, skipping the MOX fuel step, as in the Fast Reactor Recycle. These results all assume a deterministic set of assumptions. One could complicate the problem to recognize the uncertainty in future cost numbers, in which case it is possible that option (c) yields a lower expected cost than either (a) or (b), but in reality the numbers do not warrant this.<sup>4</sup>

The high cost of the ultimate disposal of the spent MOX fuel helps to explain the negative value assigned to the plutonium recovered from reprocessing the spent UOX fuel. Recycling the plutonium only *postpones* most of the cost of disposal. Instead of paying 1.30 mill/kWh for disposal of the spent UOX in the Once-Through Cycle, after reprocessing the spent UOX from the first pass there is a cost of 0.40 mill/kWh for disposal of the separated high level waste. This only appears to be a cost saving. Recycling the plutonium ultimately produces spent MOX fuel at the end of the second pass which has an even higher disposal cost—6.97 mill/kWh. Because the separated plutonium from the first pass brings with it the future liability of disposal as spent MOX, it is necessary to attribute to the plutonium a negative value. For separated plutonium, the future liability value as an ultimate waste product is greater than the future asset value as a fuel.

The assignment of a negative value to the plutonium takes a portion of the cost of MOX disposal that are realized in the second reactor cycle, and attributes them back to the first reactor cycle. Hence, the back-end fuel cycle costs for the first reactor cycle—2.87 mill/kWh—are higher than just the realized cost, 2.76 mill/kWh. The difference of 0.11 mill/kWh is the net of the credit earned for the reprocessed uranium and the debit paid for the separated plutonium.

### Fast Reactor Recycle

Table 7.4 shows the levelized cost for the Fast Reactor Recycle with a conversion ratio of 1. The table shows the LCOE for two reactors. The first is the light water reactor operating with UOX fuel produced from raw uranium: lines [1]-[11] detail this LCOE. The second is a fast reactor operating with fuel fabricated from the transuranics separated out from the spent UOX fuel: lines [12]-[23] detail this LCOE.<sup>5</sup>

**Table 7.4 The LCOE for the Fast Reactor Cycle (CR=1)**

<i>Light Water Reactor</i>		
(mill/kWh)		
[1]	Raw Uranium	2.76
[2]	Fuel Production	4.35
[3]	Front-end Fuel Cycle	7.11
[4]	Capital Charge	67.68
[5]	O&M Costs (non-fuel)	7.72
[6]	Reprocessing	2.36
[7]	HLW Disposal	0.40
[8]	Reprocessed Uranium	-0.14
[9]	Transuranics	1.43
[10]	Back-end Fuel Cycle	4.06
[11]	<b>LCOE Total</b>	<b>86.57</b>
<i>Fast Reactor</i>		
(mill/kWh)		
[12]	Depleted Uranium	0.02
[13]	Transuranics	-19.72
[14]	Fuel Production	4.05
[15]	Front-end Fuel Cycle	-15.66
[16]	Capital Charge	81.22
[17]	O&M Costs (non-fuel)	9.26
[18]	Reprocessing	2.66
[19]	HLW Disposal	0.34
[20]	Depleted Uranium	-0.01
[21]	Transuranics	8.75
[22]	Back-end Fuel Cycle	11.74
[23]	<b>LCOE Total</b>	<b>86.57</b>
[24]	Price of transuranics, \$/kgHM	-80,974

Once again, for the light water reactor burning fresh UOX fuel, the front-end fuel costs, reactor costs and non-fuel operating and maintenance costs—lines [1]-[5]—are identical to those for the Once-Through Cycle. The back-end fuel cycle cost is composed of the costs of reprocessing, the cost of disposing of the separated high level wastes, the credits earned for the stream of separated uranium and the charge paid for the separated transuranics—lines [6]-[9] summing up to line [10]. The costs of reprocessing, levelized across the electricity produced by the fuel being reprocessed, is 2.36 mill/kWh. The cost of disposing of the stream of separated fission products is 0.40 mill/kWh. The credit for recovery of uranium is 0.14 mill/kWh. Finally, a negative value is assigned to the separated transuranics, -\$80,974/kgHM, so that the allocated charge for the separated transuranics is 1.43 mill/kWh. Combining these four elements, the total back-end fuel cycle cost for this reactor is 4.06 mill/kWh. The total LCOE for the LWR reactor in this fuel cycle is 86.57 mill/kWh.

The fast reactor’s combined front-end fuel cost—line [15]—is negative, -15.66 mill/kWh. This is because of the large credit earned for accepting the recycled transuranics embedded in the fuel it purchases, -19.72 mill/kWh—line [13]. It will have to pay 0.02 mill/kWh for the depleted uranium required for the fuel, and a charge equivalent to 4.05 mill/kWh for the fabrication of the fuel—lines [12] and [14]. Capital and operating costs are assumed to be 20% larger for a fast reactor as compared to a light water reactor, yielding a capital charge of 81.22 mill/kWh and a non-fuel operating and maintenance charge of 9.26 mill/kWh—lines [16] and [17]. At the back-end, the spent fast reactor fuel is again reprocessed, separating out a mix of uranium

and transuranics and leaving a stream of high level waste composed of the fission products. The cost of this separation is 2.66 mill/kWh—line [18]. The cost of disposing of the high level waste is 0.34 mill/kWh—line [19]. The credit for the uranium is 0.01 mill/kWh, and the charge for the recovered transuranics is -8.75 mill/kWh—lines [20] and [21]. Therefore, the total back-end fuel cycle cost is 11.74 mill/kWh—line [22]. The final LCOE for the fast reactor is 86.57 mill/kWh.

### Comparing the Levelized Costs Across Cycles

The most important conclusion to draw from a comparison of the levelized cost across the three fuel cycle is that the differences between them are small relative to the total cost of electricity. The highest cost among the three, the Fast Reactor Recycle, is 2.76 mills/kWh more expensive than the lowest cost, the Once-Through Cycle. This amounts to less than

**Figure 7.1 LCOEs for Alternative Cycles, by Component**

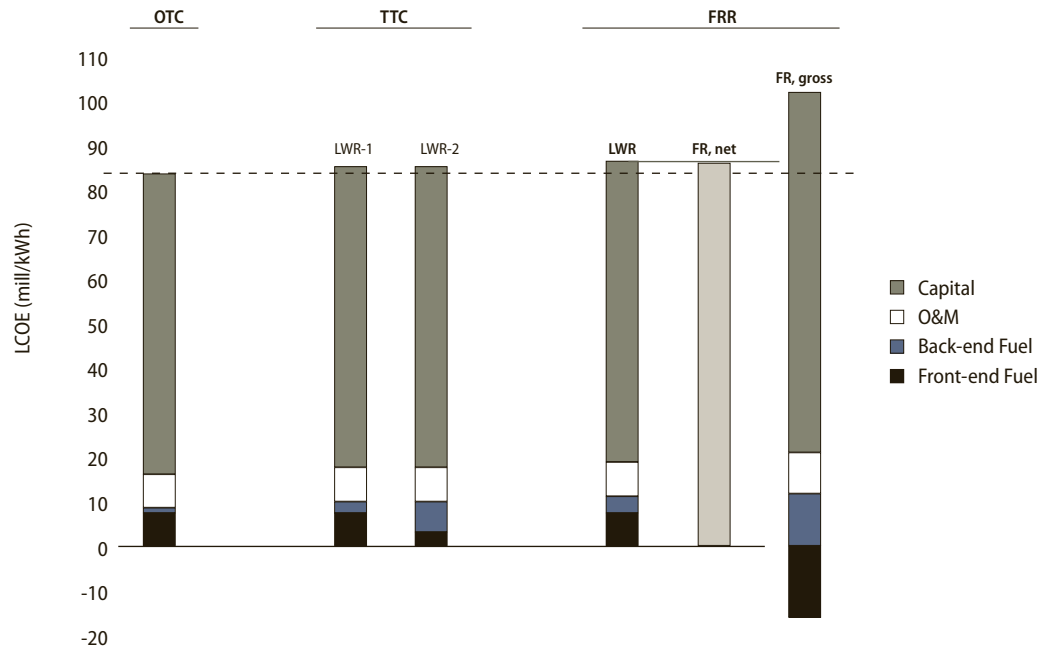

Source: 4858 US/AEC. 69-36 Nuevo EV, 87-Present Uv U308v

Notes: The graph displays the LCOE figures from Tables 7.2, 7.3 and 7.4. The first bar shows the LCOE, by component, for the Once-Through Cycle. The second and third bars show the two LCOEs for the Twice-Through Cycle: the left-hand bar is the LCOE for the first pass reactor, while the right-hand bar is the LCOE for the second pass reactor. The fourth, fifth and sixth bars show the LCOEs for the Fast Reactor Recycle: the left-hand bar is the LCOE for the light water reactor, while the center and right-hand bar show the LCOE for a fast reactor. The total fuel cycle cost for the fast reactor is negative, so that the total LCOE is less than the sum of the reactor capital and O&M costs. The center bar shows the total or net cost. The right-hand bar shows each cost component, with the capital, O&M and back-end fuel cycle costs being positive and the front-end fuel cycle cost being negative.

a 3% increase in cost. The small size of this difference shows up even more clearly in the graphical display of the costs in Figure 7.1. Thus, if a given cycle has important non-economic advantages, then these can be purchased at a reasonable cost.

The cost increase is small because fuel cycle costs are a small part of the overall total cost of electricity. The incremental cost compared to just the fuel cycle costs of the Once-Through Cycle—front- and back-end—would represent a 33% increase. Compared to just the back-end of the fuel cycle costs of the Once-Through Cycle, the incremental cost would represent a 212% increase.

The importance of the cost of reprocessing shows up clearly in a comparison of Tables 7.2 and 7.3. In the Once-Through Cycle, the cost of disposal of the spent UOX fuel is 1.30 mill/kWh. If, instead, the fuel is to be recycled, the cost of reprocessing is already 2.36 mill/kWh. This is before accounting for the cost of disposing of the separated high level waste and the credits or charges for the separated uranium and plutonium. This is almost double the cost of direct disposal. It is easy to see that it would be hard for this cost difference to be made up for by the savings on raw uranium needed for the second reactor: the total cost of uranium for fresh UOX is only 2.76 mill/kWh. On top of this, the cost of fabricating MOX fuel are much, much higher than the cost of fabricating fresh UOX fuel. Finally, the much

higher cost of disposal of the spent MOX fuel guarantee that the Twice-Through Cycle will be greater than the cost of the Once-Through Cycle.

For the Fast Reactor Recycle, the numbers in Table 7.4 tell a similar story about the high costs of reprocessing and waste disposal as compared against modest savings on raw fuel. In this case, though, the higher ultimate waste disposal costs are not as obvious. There is not a high disposal cost charged to the fast reactor as in Table 7.3 for the second pass reactor in the Twice-Through Cycle. This is because in the Fast Reactor Recycle, the transuranics continue to be recycled, while in the Twice-Through Cycle the spent MOX was sent for direct disposal. But this recycling only postpones the realization of the high liability of managing the transuranics. The future liability of managing the transuranics is recognized through the high charge assessed for their removal.

For the Fast Reactor Recycle one additional factor also comes to play in a comparison with the Once-Through Cycle. The capital and operating costs for the fast reactor are so much higher than the capital and operating costs for the light water reactor—15.08 mill/kWh in total. This differential is so large that no amount of savings on the use of raw uranium could outweigh it—given the assumed price of uranium.

Table 7.5 shows how the LCOE for the Fast Reactor Recycle varies with the conversion ratio. Given the assumed parameters, the LCOE is lowest for a burner reactor and highest for a breeder reactor. This is because of the assumption that fast reactors are more expensive than light water reactors. From the perspective of generating electricity, it is cheaper to use light water reactors, and a cycle with a low conversion ratio generates more of its electricity with light water reactors. The value of the fast reactor is their handling of the transuranics. Since the transuranics are a liability, it is best to use the expensive fast reactors, if at all, for the purpose of burning those transuranics.

**Table 7.5 Impact of the Conversion Ratio on the Fast Reactor Recycle LCOE**

	CR = 0.5	CR = 1	CR = 1.2
1. Price of transuranics, \$/kgHM	-41,100	-80,974	-100,534
2. LCOE, mill/kWh	85.86	86.57	86.91

## CITATIONS AND NOTES

1. At a finer level of policy analysis, a case might be made for particular risk-sharing arrangements between state and private entities. These risk-sharing arrangements could optimize performance incentives or provide other important advantages for efficiently implementing a nuclear program. Such tactical considerations do not alter the general perspective that the aggregate social cost of a nuclear fuel cycle must be evaluated using a cost of capital comparable to what would be employed by any commercial entity, and that this cost of capital is roughly constant across cycles.
2. The methodology is described in the Appendix. A more detailed presentation appears in De Roo, Guillaume, and John E. Parsons, A Methodology for Calculating the Levelized Cost of Electricity in Nuclear Power Systems with Fuel Recycling, *Energy Economics*, forthcoming 2011, doi 10.1016/j.eneco.2011.01.008. Although a few parameter inputs vary, the calculations follow by exactly the same steps. A spreadsheet containing the detailed calculations is available on the web for download at [http://web.mit.edu/ceep/workingpapers/DeRooParsons\\_spreadsheet.xls](http://web.mit.edu/ceep/workingpapers/DeRooParsons_spreadsheet.xls).
3. In our 2009 *Update of the 2003 Future of Nuclear Power* Report we calculated a base case LCOE for nuclear power of 8.4¢/kWh, which matches the figure reported here. The key inputs to the two calculations are the same, although there are some minor differences in a few inputs and in the format of the calculation and therefore the outputs are not strictly comparable. The main difference in format comes from the fact that the *Update* calculation uses a nominal Weighted Average Cost of Capital of 10% and an inflation rate of 3%, while the calculations in this report are done in real terms. Therefore we use the equivalent real Weighted Average Cost of Capital of 7.6% as our discount rate.
4. De Roo, Guillaume, Economics of Nuclear Fuel Cycles: Option Valuation and Neutronics Simulation of Mixed Oxide Fuels, Masters Thesis, MIT, 2009.
5. In the Fast Reactor Recycle, spent fast reactor fuel is also reprocessed and the separated transuranics and uranium mixture is once again fabricated into fuel for another pass through a fast reactor. To a first order approximation, the LCOE will be the same whether the fast reactor uses transuranics separated out from spent UOX fuel or a mixture of transuranics and uranium separated out from spent fast reactor fuel.



# Chapter 8 — Fuel Cycles and Nonproliferation

The Nuclear Non-Proliferation Treaty (NPT), which came into force in 1970, underpinned a largely successful international nonproliferation regime for several decades. It achieved this by balancing interests through three principal commitments:

- ▣ agreement by non-nuclear-weapons states to refrain from any attempt to develop or acquire nuclear weapons and to accept internationally administered safeguards on nuclear facilities;
- ▣ agreement by the nuclear weapons states to move in the direction of nuclear disarmament;
- ▣ agreement by all to cooperate on the peaceful use of nuclear technology, including global nuclear power development.

However, the last decade has proved challenging, with all three pillars of the NPT facing a new dynamic.

In regard to the first pillar, programs in Libya and North Korea and the extent of the A. Q. Khan network centered in Pakistan were revealed. While Libya renounced its program, North Korea withdrew from the NPT and tested nuclear explosives. India, a non-signatory to the NPT, received a waiver from the Nuclear Suppliers Group to engage in nuclear commerce. Iran, while claiming that its program is for peaceful purposes, has hidden uranium enrichment projects, suggesting to many a nuclear weapons motivation.

The reach of international terrorist organizations also came into sharper focus in this decade, starting with the events of 9/11. Al Qaeda has explicitly expressed its desire to acquire nuclear weapons. This has reenergized the disarmament discussion by raising the question as to whether the risks of having a nuclear weapon or weapons-usable fissile material fall into the hands of well-financed terrorists outweigh the post-Cold War security benefits of nuclear weapons and weapons-usable materials stockpiles.<sup>1</sup>

At the same time, an expectation grew that nuclear power would, after a period of very slow growth worldwide, start on a new trajectory of major expansion, largely outside the industrialized countries that currently operate most of the nuclear fleet. For example, in the Mideast alone, Iran, UAE, Jordan, Saudi Arabia, Egypt, Turkey, and Syria have all expressed intent to pursue nuclear power. To the extent that these countries construct and operate nuclear power reactors without engaging in uranium enrichment or plutonium separation from irradiated fuel, the proliferation risks are minimal and assistance from the nuclear suppliers in line with the NPT is expected. The concern is that the nascent nuclear



power program might be used, as is being done in Iran, to justify fuel cycle development. The primary obstacle to a nuclear weapons program remains access to the needed fissile material – high enriched uranium (HEU) and separated plutonium. With enrichment or reprocessing capability, even one obtained as a legitimate activity under the NPT, the risks are for a “breakout capacity” to produce weapons material or for clandestine facilities based upon the technology and experience gained in the fuel cycle. While the Iranian situation is of the greatest concern with regard to proliferation related directly to nuclear power development, the renewed commitment to enrichment in Brazil and the commissioning of a large commercial reprocessing plant in Japan have added to a sense that fuel cycle facilities may be spreading geographically along with the anticipated “nuclear renaissance”. Such an outcome would present a fundamental challenge to U.S. nonproliferation policy, but is nevertheless interpreted by a large number of non-nuclear signatories to the NPT as consistent with the NPT so long as full scope safeguards are implemented. The question is on the table as to whether or not the NPT needs reexamination in order to address this “threshold state” concern that a country could reach the brink of a nuclear weapons program with domestic activities and fuel cycle assistance permitted under the NPT. The threshold state phenomenon can significantly impact geopolitical realities even if the country does not cross the threshold, as evidenced in the Middle East.

In this report, we focus only on the proliferation risks associated with international fuel cycle development and on their mitigation through institutional and technical means. Clearly, the issues posed by clandestine nuclear weapons programs outside the nuclear power sector are of great importance, but they are outside the scope of our fuel cycle analysis. Our discussion is framed by the conviction that, at least for the near to intermediate term, the U.S. focus should be on approaches that are within the existing NPT framework, that are based on economic incentives, that recognize the diminished role of the U.S. as nuclear supplier to the world, and that entail U.S. participation in international fuel cycle development.

## CONTEXT

There are two issues of context that deserve some elaboration for a discussion of proliferation and the fuel cycle: the nature of weapons-usable fissionable materials in the fuel cycle, and the likely extent of nuclear power international deployment over the next several decades.

It has been stated often and by many that acquisition of nuclear weapons usable fissionable material, HEU or plutonium, is the most significant challenge for developing a nuclear explosive. This is correct.<sup>2</sup> Consequently, the fuel cycle facilities of concern are enrichment plants and reprocessing facilities. The former employ the same basic technology for producing low-enriched uranium (LEU) for LWR fuel (with enrichments typically in the 4-5% range) or HEU for weapons (technically defined as U235 enrichment above 20%, but in reality greater than 90% for weapons programs). The technologies in commercial use today, gaseous diffusion or centrifuges, are relatively difficult to master since they work on physical separation of isotopes with less than 1% mass difference (the separation is performed on the UF<sub>6</sub> molecule). The technologies are classified in all countries that have developed them, although leakage is known to have occurred through the Khan network tracing back to stolen early European centrifuge designs.

On the other hand, reprocessing for plutonium separation from SNF is a chemical process and, while high safety and health standards are needed for large throughput commercial operation, the basic approach is well known. There is no isotopic separation, just chemical separation of different elements. For nuclear explosive use, different plutonium isotopic mixtures have very similar critical masses. Therefore, physical safeguards and associated accounting schemes for SNF and separated plutonium are essential to the nonproliferation regime.

However, there is sometimes confusion about the quality of the fissionable material produced in the fuel cycle with respect to weapons usability. While having at least a critical mass of material is essential, other characteristics are important as well. The issues revolve around neutron background and heat generation for different isotopic mixtures. The importance of minimizing neutron background for high yield nuclear explosives is already discussed in the Los Alamos Primer<sup>3</sup> that presents the original lectures delivered to the wartime Los Alamos design team. High heat levels complicate design for use of the chemical explosives used to detonate the weapon.

HEU has the best of both characteristics – low neutron background and heat - and thus poses the easier design route to a nuclear explosive. A great deal of the work needed to reach 90% enrichment has already been accomplished in reaching 5%, so high standards of control on LEU and on enrichment technology are needed.

The dominant fissile isotope of plutonium is Pu239, bred in a two step process by neutron capture on U-238 as the LWR LEU fuel is utilized. Weapons grade plutonium is predominantly made up of this isotope (over 90%). However, in a commercial reactor, the fuel remains in the core for several years and many other plutonium isotopes are produced in significant quantities through sequential neutron capture. In particular, the even isotopes (Pu-238,240,242) produce large neutron backgrounds and considerable heat, and there are significant differences for different fuel cycles.

Figure 8.1 displays the spontaneous neutron and heat levels for six materials in different fuel cycles, in each case normalized to one kilogram of plutonium. Weapons-grade plutonium has very low heat and few neutron emissions; it is produced for dedicated weapons programs in dedicated reactors with low fuel burnup to minimize production of higher isotopes. Its desirability for weapons use compared with commercial fuel is evident in the figures.

The diamond closest to the origin shows the heat and neutron emissions of a kg of plutonium separated from LWR SNF in once-through operation. Both heat and neutron backgrounds are substantially greater than those for weapons-grade. However, the result for the full TRU content, shown as “1 kg Pu plus all other actinides, discharged from a LWR” is seen in the bottom figure to be dramatically greater. Including the fission products raises the heat level substantially. The high amounts of heat and neutrons are responsible for the self-protecting nature of the SNF. Of course, this SNF cannot be used for a nuclear explosive (as opposed to “dirty bomb”<sup>4</sup>) without separation of the plutonium.

MOX(Pu) corresponds to the case of once-recycled MOX. It has appreciably higher heat and neutron emissions compared to once-through LWR Pu, although not qualitatively different. The once-through fast reactor Pu result is similar. However, it is important to note that the neutron characteristics are important not only for judging weapons usability but also for evaluating fuel refabrication for closed fuel cycles. Clearly the increased background

**Figure 8.1 Weapons-Usability Characteristics of Nuclear Fuels**

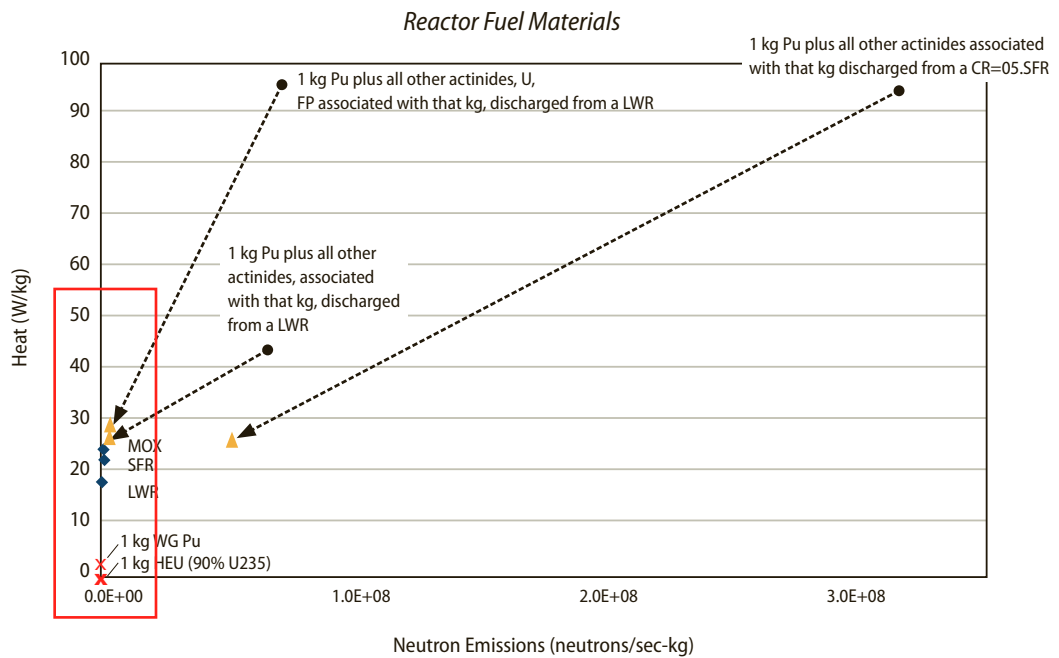
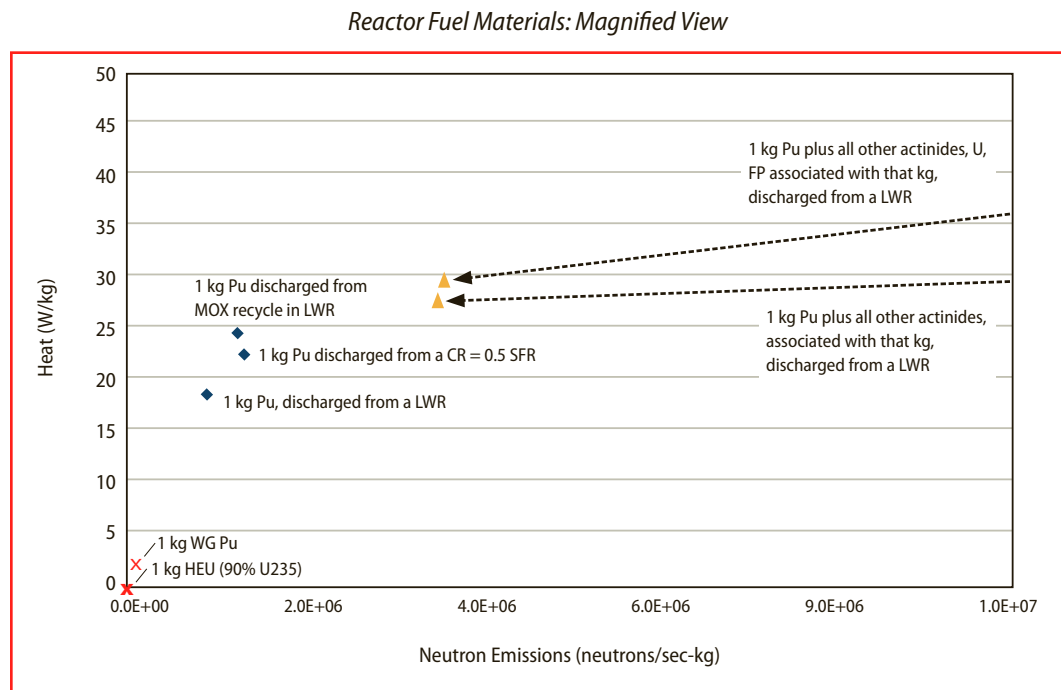

Note that dotted arrows connect endpoints; they do not represent the true decay path over 100 years.

Source: Heat and spontaneous neutron emissions from weapons-grade plutonium, spent fuel from LWR (4.2% enrichment, 51 MWd/kg burnup) and spent fuel from a Fast Reactor (FR - conversion ratio 0.5, "equilibrium" fuel pass). For reference, HEU: 2.3 n/sec-kg, 5.3E-05 W/kg; WG Pu: 1.0E+05 n/sec-kg, 2.3 W/kg.

Data credits: E. Hoffman (2009) – FR spent fuel, B. Forget (2010) – LWR spent fuel.

raises the cost, with the need for worker health and safety being paramount, leading to fully remote operation and maintenance. While we cannot be quantitative here in characterizing weapons usability, the MOX materials are considered to be of proliferation concern. It must be kept in mind that high yield reliable nuclear weapons are not required in many contexts: a crude lower nuclear yield device can be effective for national aims in regional contexts and for terrorist groups. This lower standard for nuclear explosives means that lower-grade fissionable materials can be used.

Keeping all the transuranics (TRU) associated with the Pu extracted from LWR irradiated fuel (i.e., including the minor actinides) appreciably increases both heat and neutron background. Perhaps of more interest, the heat and neutron emissions for an “equilibrium” full TRU recycle in a fast reactor are even larger (ten years after removal from the reactor). This would pose an extraordinary challenge for misuse in a nuclear weapon, effectively requiring further partitioning.

Another important issue is the fuel characteristic after a considerable storage time. The vectors on Figure 8.1 show what happens after one hundred years. Clearly the once through LWR fuel loses a considerable part of its radiation barrier, emphasizing the need for continuing safeguards. The fast reactor “equilibrium” TRU fuel still retains a very substantial neutron emissions background even after a hundred years.

The conclusion from this venture into plutonium isotopics is that separation of plutonium from SNF provides material that is clearly not as desirable as weapons grade but that nevertheless represents a major risk unless safeguards, accountability, and security are all at the highest standards at all locations where such material is stored. This has taken on additional gravity in the context of increasingly sophisticated terrorist groups with international reach and ambitions.<sup>5</sup> The characteristics of separated TRU on the other hand, particularly that under discussion for closed fast reactor fuel cycles, is far less desirable and usable for explosives. However, for the same reasons, it will pose a major challenge for safe and economic fuel cycle operations.

Another contextual issue is the anticipated spread of nuclear power and its attendant proliferation concerns. These concerns are centered mostly on countries that are just beginning or just thinking about building nuclear power programs. The programs will be small for quite some time, relative to the scale at which investments in fuel cycle facilities make economic sense. Of course, the growth trajectory for nuclear power is unknown: a commitment to mitigating CO<sub>2</sub> emissions could still spur a major expansion, but the high capital costs or a serious nuclear accident could dampen such prospects substantially. The 2003 MIT Future of Nuclear Power report constructed a scenario of what a one terawatt global nuclear deployment might look like in 2050. Even in such a growth scenario, the result was that about 80% of the deployed nuclear power would still be in the major nuclear states in that time frame. It is important to keep this in mind in contemplating the scale of the proliferation challenge associated with fuel cycle development: the challenges are substantial, but are likely to be relatively few in number. Today, the trajectory for nuclear power growth is below the terawatt path.

## INSTITUTIONAL APPROACHES TO FUEL CYCLE PROLIFERATION CHALLENGES

The principal objective of international fuel cycle nonproliferation policy is limitation of the spread of enrichment and reprocessing facilities and technology, most especially in regions of geopolitical concern. For the last quarter of the 20<sup>th</sup> century, these objectives were largely met. The Nuclear Suppliers Group (NSG), formed after the Indian nuclear explosive test in 1974, grew to treat such facilities differently from reactors and fuel supply. This has stemmed from an interpretation of the NPT by the NSG that there is not a requirement to assist with such technologies and, to a very large degree, a lack of interest by non-NSG members to acquire them.<sup>6</sup> In the early years of the NSG, agreements such as that for German supply of end-to-end fuel cycle capability to Brazil were not implemented.

During this period, the United States played a dominant role. Among many factors underpinning this role was the leading U.S. position in the global nuclear technology business. The nearly forty year hiatus in ordering new nuclear plants in the U.S. has taken its toll on national capacity, and many other countries now have effective and competitive nuclear industries. The days of a near monopoly by U.S. companies on nuclear technology will not return. Indeed, it will be a challenge to reestablish a major position as even more players emerge on the international market, such as Russia, South Korea, and China. Nonproliferation policies with regard to the fuel cycle need to evolve in step with these commercial realities.

Instead, the United States has, in recent years, given increased emphasis to limiting the spread of enrichment and reprocessing through its bilateral agreements on the Peaceful Uses of Atomic Energy (the so-called 123 agreements). It is a very bad idea to adopt this as a universal approach. The UAE included a binding commitment to abstain from enrichment and reprocessing in its 123 agreement with the United States; this is a welcome statement of leadership by the UAE. Nevertheless, it is unrealistic and unproductive to expect that this can be extended universally. First the United States already has executed many 123 agreements without this condition, including in the Middle East (Egypt and Turkey), and it cannot be expected that the condition would be negotiated into renewals. Second, the Department of State has suggested that the condition would be applicable in the Middle East, with different regions treated differently. Yet Jordan and Saudi Arabia, for example, have already signed nuclear cooperation agreements with major supplier countries without such a condition. While the U.S. negotiated the UAE agreement with the fuel cycle restrictions, South Korea successfully won the bid for construction of the first nuclear power reactors in the UAE and indeed in the region. The other members of the NSG show no indication of formalizing restrictions that go beyond the NPT in their cooperative nuclear agreements. The U.S. approach is ad hoc and does not add up to a strong policy.

A broad-based attempt to impose abstention through bilateral cooperative agreements will have at least two negative impacts. It raises the temperature on how Article IV of the NPT is interpreted, and it will serve to further diminish the U.S. role in international nuclear commerce if it blocks entry into additional 123 agreements or impedes agreement renewals. This will serve neither security nor economic interests. And the ability of the U.S. to improve its position in that global market, as already stated, faces enormous challenges of rebuilding both a domestic market and a nuclear industrial capacity as a platform for international sales and influence.

At least for the near term, economic incentives should be aligned with security goals, and a focus on a multilateral NSG approach based on fuel cycle economic realities has a higher probability of success. We have seen that the economically most sensible fuel cycle approach for “green field” nuclear power programs is, and will remain for some time, LWRs for electricity with long term storage of first-pass irradiated fuel. This supports an approach based on economic incentive for limiting the spread of reprocessing, at least for several decades. For fresh LWR fuel, limiting the spread of enrichment will require an economic and secure supply. For small nuclear power deployments, as is the case for green field programs, the economic choice is clearly purchase of fuel on the international competitive market.

The SNF will eventually require geological isolation of some or all of its constituents, depending on whether SNF partitioning and/or recycling of plutonium/TRU is implemented in the long term. Experience suggests that establishing national geological isolation programs requires substantial resources and a political process that can be sustained over a very long period. Avoiding this challenge carries substantial incentive for small nuclear programs. This suggests a fuel leasing approach: the nuclear fuel supplier retains ownership of the fuel and removes the SNF after a short cooling period back to the country of origin or possibly to a third country that establishes an international geological repository. Clearly the challenge that faces such an approach today is the willingness of the fuel supplier (or third party country) to accept the SNF without requiring return of the constituents: in other words, to lease the fuel rather than sell the fuel and provide storage/reprocessing services. The fuel supplier would of course treat the returned SNF as it does its own, ideally long term storage for many decades until the optimum fuel cycle path is determined. Without minimizing the difficulty of SNF return, for this is indeed a major challenge, we stress that the nuclear growth scenario described above suggests that the returned SNF in question would likely be a small fraction of the SNF handled in the fuel supplier’s domestic program. In the U.S., irradiated fuel from research reactors has already been returned for nonproliferation reasons. The public must be informed about the tradeoff of a relatively small increment to the waste management challenge in return for a major strengthening of the nonproliferation regime, at least for the decades it will take to gain more clarity on the growth trajectory of nuclear power globally and the technology pathways for fuel cycle development. *The failure to develop a broadly-accepted domestic SNF storage and disposal strategy limits U.S. nonproliferation policy choices in the context of nuclear fuel cycles; thus, nonproliferation objectives are served by effective waste management strategies.*

One specific approach along these lines has been termed the Assured Nuclear Fuel Services Initiative (ANFSI).<sup>7</sup> It specifically suggests that the leasing scheme be implemented between commercial entities negotiating commercial contracts for fuel-service transactions. Importantly, the contracts should, as is customary, have a fixed term, say ten years, during which time the country leasing the fuel would agree to abstain from developing either enrichment or reprocessing capability. There is a commercial logic to this abstention in that the leasing country is not developing the capacity to compete against the supplier during the contract period, in return for the benefits of economic supply of fresh fuel and elimination of the waste challenge. The IAEA would apply safeguards to such transactions, ideally in the framework of the Additional Protocol (see box). Of course the contracts can be renewed for another period. The benefits of securing the nonproliferation advantages of fuel leasing for a material period such as ten years should not be underestimated, rather than chasing the illusion that countries will by treaty or long term binding agreement give up “rights” that they insist are part and parcel of the NPT deal. Frankly, this will not happen except perhaps in isolated cases, as should be evident from the experience of the last decade.<sup>8</sup> ANFSI does

### The IAEA Additional Protocol

An IAEA fact sheet on safeguards states:

“The Additional Protocol is a legal document granting the IAEA complementary inspection authority to that provided in underlying safeguards agreements. A principal aim is to enable the IAEA inspectorate to provide assurance about both declared and possible undeclared activities. Under the Protocol, the IAEA is granted expanded rights of access to information and sites.”<sup>8</sup>

The Additional Protocol allows IAEA inspectors to request information and inspect any fuel cycle facilities within a country that has signed the agreement. The IAEA can further request information about fuel cycle R&D within the country, as well as examine facilities and systems for the export or import of nuclear-related goods. Perhaps most importantly, the additional protocol allows for expanded sampling and inspection, so that IAEA inspectors can detect activity beyond the boundaries of declared nuclear sites.

<sup>8</sup>International Atomic Energy Agency, “IAEA Safeguards Overview: Comprehensive Safeguards Agreements and Additional Protocols,” Vienna, Austria. Web-based factsheet: [http://www.iaea.org/Publications/Factsheets/English/sg\\_overview.html](http://www.iaea.org/Publications/Factsheets/English/sg_overview.html), accessed September 3, 2010.

not contemplate reopening the NPT for a contentious negotiation that is unlikely to succeed, especially in the absence of a consistent position even among the Nuclear Suppliers Group (NSG). It is a voluntary approach based on economic incentive and the notion that a spotlight will be placed on countries that decline an obviously good deal. The recent international approach to Iran provides some hope that a spotlight can be effective in turning up the heat when proliferation concerns are evident.

ANFSI contemplates going further in terms of economic incentive for fresh fuel purchase on the international market. Enrichment services are a small part of nuclear power costs, a fraction of a cent per kWh of electricity. Even if the enrichment costs were fully subsidized for early stage nuclear power programs as part of a non-proliferation-motivated incentive to avoid enrichment development during the contract period, the total costs would be less than a billion dollars per year for the next couple of decades. We are not advocating such a direct subsidy of the full enrichment costs, but it is useful to see that the scale is small, so there can be many attractive ways to encourage participation in the leasing approach through economic incentive in fuel supply (in addition to the benefit on the

waste management side). In addition to direct approaches (credits, price discounts, insurance and export financing), indirect approaches such as a link to carbon credits for avoided emissions could be pursued.<sup>9</sup>

There has been much discussion about internationalizing fuel cycle facilities, going back over sixty years and given some renewed impetus in 2005 by the IAEA (see Table 8.1 for a selective history). Of course, such proposals have made little progress in the face of national prerogatives, with the possible exception of the recent attempt to establish a fuel bank for security of supply for those without enrichment capacity. This is not in conflict with ANFSI. For example, enrichment plants with international shared ownership and IAEA safeguards could be the entity entering into the commercial contracts, possibly in competition with private companies. URENCO, originally a German, Dutch, British consortium, was established through a limited form of international ownership. This would be a plus in regards to security of fresh fuel supply and far preferable to a profusion of national enrichment facilities, especially if combined with a robust international fuel bank. However, it would not address the most challenging aspect of fuel leasing, return of the SNF and eventual geological isolation of HLW, and indeed could even complicate it. The repositories still need to be in sovereign countries, and a commercial attraction of fuel leasing is revenue enhancement in supplier countries.

**Table 8.1 A Selective History of International Nonproliferation Initiatives**

DATE	INITIATIVE	OBJECTIVES	RESULT
1946	Baruch Plan	U.S. proposal for intense oversight/ international management of the civilian nuclear fuel cycle	Vetoed by Soviets, who oppose facility inspections and giving up a U.N. veto on atomic matters
1977	Regional Nuclear Fuel Cycle Centers Study	Study initiated by the IAEA to assess feasibility of establishing multinational fuel cycle facilities	Study finds that facilities are technically feasible, but too many challenges exist with tech transfer and providing security of supply
1975–1980	International Nuclear Fuel Cycle Evaluation	Study initiated by the U.S., conducted by the IAEA and other countries and orgs - intended to address the technical connections between fuel cycles and weapons	Study finds that no technical solution is adequate; process contributes to rollback of nuclear supplier intentions to provide enrichment/reprocessing technology (e.g., Germany to Brazil)
1980–1987	Committee on Assurance of Supply	IAEA group addresses fuel banks and other supply strategies	–
2005	Multilateral Approaches to the Fuel Cycle	IAEA Director General requests a report describing options and outlooks for MNAs	Impact includes some increased interest in multinational fuel cycle arrangements
2006	NTI commits \$50M for bank	Drum up interest and matching funds for an LEU bank	Total \$150M goal reached with Kuwait's donation in March 2009
March 2010	IAEA and Russia sign fuel bank agreement	Establish a 120-MT LEU stockpile in Angarsk, Russian; IAEA will control sales from the stockpile	Russian authorities declare fuel bank operational in Dec. 2010

Clearly ANFSI and other fuel leasing approaches face some core challenges: security of supply, technological leadership, and political asymmetry.

**Security of supply:** As already noted, international enrichment facilities would provide a degree of security of supply, but other approaches do so as well. Government-to-government assurances that fuel services will not be withheld for any reason other than a material violation of international non-proliferation commitments under the NPT and IAEA safeguards agreements would backstop commercial contracts. Even this will still need to be backed by a firm multilateral guarantee. In particular, the IAEA, with assistance from the Nuclear Threat Initiative and several countries, has established a fuel bank to address this. The IAEA should be authorized by the United Nations Security Council to assume a guarantor role through the fuel bank or fuel reserve, ensuring access to the contracted fuel services so long as nonproliferation commitments are observed. The Additional Protocol is important in this regard. The IAEA role could be extended with respect to nuclear fuel supply to a coordinating role analogous to that of the International Energy Agency in cases of supply disruption in the oil markets. Further, the long term contracts with fixed prices dispel price volatility concerns during the contract term.

**Technological leadership:** Some countries argue that a fuel leasing arrangement combined with the commitment to abstain from enrichment and reprocessing will prevent development of indigenous technological leadership. These arguments are not compelling for a ten year contract period – and probably not for periods beyond that. First, the technologies in question are not likely to form the basis of a major contribution to the national economy, especially given that fuel cycle evolution is not clear at the moment and fuel services represent a small part of the cost of nuclear power. The spillover effects of national investments



in technology innovation are likely to be much greater in other sectors. Further, there is no permanent rejection in ANFSI of the “birthright” to develop enrichment and reprocessing technology, just a decision to abstain for a fixed contract period as a judgment of net economic and political benefit, during a period in which the future of nuclear power and fuel cycle development become clearer. Finally, those agreeing to the leasing conditions should be admitted, without additional political tests, to an international R&D program on advanced reactors that could be central to future fuel cycles. This cooperation would not extend to enrichment or reprocessing technologies and would require participation in the Additional Protocol. The R&D program should have a period of laboratory research, conceptual design, and modeling and simulation rather than near-term large-scale demonstration facilities.

**Asymmetry and incentives:** The criticism of creating another set of “haves” and “have-nots” layered on top of the NPT distinction of nuclear weapons states has been leveled at fuel leasing approaches. However, ANFSI calls for voluntary entry into fixed-term contracts with both economic and political incentives. The nonproliferation benefits include lock-in for the contract period of commitments to abstain from enrichment and reprocessing technology development and a spotlight on countries with nascent nuclear power programs that choose not to gain the economic and political benefits offered.

Indeed, the biggest asymmetry in ANFSI is really in the other direction: the suppliers take full responsibility for waste management, with the evident domestic political challenges of winning public support in the interests of nonproliferation policy. The saving grace here may be the relatively small increment in waste management responsibilities in most cases. As a second-best option, the supplier state should agree to retrieve the SNF for long term storage and to return no more than the fission products (within reasonable specifications for TRU), no earlier than one century later; Russia is moving in this direction. If the supplier state is pursuing a closed fuel cycle within that period, there is no issue. If not, the choice would be SNF disposal or partitioning of the fission products and disposal of the TRU through transmutation, mixing with HLW, deep boreholes, or some other secure means; with a functioning repository program at that time, the direct SNF disposal is likely to be the choice in the absence of a closed fuel cycle. Of course, if the supplier states cannot bring themselves to take back the SNF in the context of publicly accepted waste management systems, the path will be open to a multiplicity of reprocessing operations some time in the future, with its attendant proliferation risks.

Clearly, ANFSI and other fuel leasing approaches face considerable challenges for implementation. Indeed, the recent history with regard to Iran and Brazil highlights this fact. Both situations, for very different reasons, would logically be amenable to an ANFSI-like approach, but the U.S. and international responses have not been shaped by the economic arguments in concert with declared nonproliferation objectives of all parties. Instead, the very different perception about national intentions in these two cases has led to diametrically opposite responses that weaken the prospect for a consistent international regime.

In summary, we recommend that the United States pursue its fuel cycle nonproliferation agenda by continuing to emphasize cohesion within the NSG and by providing economic and political incentives for commitments to abstention from enrichment and reprocessing technology development and deployment in nascent nuclear power programs. The flip side of the incentives coin is a focus on those countries that reject an attractive offer and the resulting enhanced opportunity for targeted multilateral approaches towards the fuel cycle activities of these countries.

## TECHNICAL APPROACHES TO FUEL CYCLE PROLIFERATION CHALLENGES

Any end-to-end nuclear fuel cycle can contribute to proliferation in that it requires enrichment capacity and/or produces plutonium. The principal barriers to proliferation are institutional: most important are the commitments of most sovereign nations to not acquire or develop nuclear weapons based upon self-interest, and negotiated international agreements and implementing agencies, such as the NPT and the IAEA, respectively. Nevertheless, technical means can contribute significantly to the implementation of nonproliferation norms, enhancing transparency for the international community, confirming security of nuclear materials for operators, and raising the bar against diversion. We shall touch on a few topics directly relevant to nuclear fuel cycle development: technology choices guided by proliferation resistance criteria, and technical safeguards.

### Fuel cycle choices

Plutonium is the weapons-usable material produced in the current fuel cycle, since it is created from the dominant uranium isotope in LEU fuel, U-238, in the neutron environment of the reactor core. Figure 8.1 spells out the technical dimensions of the materials issue. One proliferation-resistant choice is the LWR once-through fuel cycle since the plutonium remains in a very high radiation environment. The least attractive cycle for proliferation resistance is the MOX/PUREX cycle in which plutonium is extracted from irradiated fuel for recycling. We saw in Chapter 6 that this fuel cycle does not have economic or waste management benefits, but it has nevertheless been practiced for decades by some countries with sunk costs in large reprocessing facilities (sometimes constructed for dual military-civilian purposes). Unfortunately more than 250 metric tons of separated plutonium has accumulated in storage. While the security standards have generally been very good in the western countries with these stocks, this accumulation of plutonium is very unappealing and sets an unfortunate example for nascent nuclear power programs elsewhere. Strong safeguards and security of the stockpiles are essential.

The choice of full recycle of TRU in fast reactors leads to material that is clearly unattractive for nuclear weapons purposes (see Figure 8.1). This is, in principle, beneficial for the nonproliferation regime. However, by the same token, the fuel cycle will be more challenging to operate, and possibly too expensive. It would seem impractical that such a fuel cycle would operate in countries with small programs. On the other hand, fuel cycle “parks” (either international or nationally operated as part of a large nuclear enterprise) with such reactors could accept LWR SNF from countries with small programs and process the fuel to supply the fast reactors – in effect, acting as a waste management program for the LWR TRU. Such a choice would mimic the leasing approach of spent fuel takeback. Theoretically, this fuel cycle (including the waste management “service” for LWRs in small programs) possesses a high degree of proliferation resistance. However, the technical challenges of realizing such a fuel cycle economically are formidable and will require decades of research and development. The intermediate risk is that evolving nuclear power programs could adopt the argument that the MOX/PUREX cycle will be a bridge to full TRU recycle in the long term. This quite possibly could be a bridge to nowhere other than enhanced proliferation risk or worse.

## Reprocessing choices

Commercial reprocessing of LWR SNF has used the aqueous solvent extraction PUREX process. It produces three streams: very pure plutonium; uranium; fission products and minor actinides. Other aqueous approaches have been developed that avoid separation of pure plutonium (e.g., UREX, see Appendix E). However, there is a view that the process chemistry can be changed easily to separate out the plutonium, so the degree of nonproliferation advantage gained by these alternatives is debated.

Pyroprocessing has been developed as an alternative approach, especially well-suited to metallic rather than oxide fuels. The plutonium extracted through pyroprocessing is mixed with some rare earth elements, uranium, and other actinides. The Idaho National Laboratory has worked on pyroprocessing in order to handle metallic fuel from the Experimental Breeder Reactor II. Extensive work is going on in South Korea to develop this technology, under the argument that pyroprocessing is more proliferation resistant.

The major pyroprocessing proliferation advantage is that all operations take place behind considerable shielding with robotic manipulators and consequently the facility may be easier to safeguard. Further, since they are more compact and modular than large scale aqueous facilities, they could reasonably be co-located with one or two fast reactors and integrated into an effective safeguards system. On the other hand, material accounting becomes more challenging and pyroprocessed materials are in metallic form, potentially providing important experience for weaponization. All in all, pyroprocessing may improve on PUREX with respect to proliferation resistance, but not sufficiently so as to drive the fuel cycle and reactor choice or policy choices of the U.S. on the disposition of U.S.-origin fuel. And the reality is that countries entering into reprocessing in the relatively near term are much more likely to choose the well understood, relatively straightforward aqueous process.

## Enrichment choices

A key nonproliferation issue is detection of enrichment facilities that could be used to make HEU. The first generation of large scale commercial (or dual use) enrichment technologies was that of gaseous diffusion. Its footprint and power requirements are very considerable for a scale relevant to a weapons program (and certainly for the larger scale needed for a commercial plant), meaning that it is a difficult technology to hide from modern surveillance capabilities.

Centrifuges, the second generation technology, offer a much smaller footprint in terms of space and power. The associated difficulty in detecting such plants was played out with the belated discovery of Iran's hidden centrifuges. This technology does require special materials to withstand the centrifuge operating conditions, and these can be monitored to a degree, but the success in evading detection in Iran for quite some time suggests the limits of these approaches. A major complication is that even special materials and critical components for centrifuges increasingly have multiple civilian applications; examples are carbon fiber for centrifuge rotors, golf clubs, commercial aircraft, and myriad other uses, and precision motor controllers. Safeguarding and materials accounting in declared enrichment plants is challenging; detecting clandestine facilities in which the centrifuge technology has been replicated is even more so. The Additional Protocol is aimed at addressing such problems, but it is not in effect in a number of countries of interest (such as Iran).

We may now be on the threshold of third generation technology with a further significant reduction in footprint and power requirement (and therefore cost of enrichment services, providing the commercial imperative for development and deployment). In particular, laser advances over the last several decades have led to numerous efforts at developing isotope separation (equivalently enrichment in a specific isotope) technologies based on selective atomic or molecular excitations. A specific Australian-origin technology called SILEX (Separation of Isotopes by Laser Excitation) has been advanced to the Nuclear Regulatory Commission (NRC) for licensing by the Global Laser Enrichment (GLE) consortium (GE-Hitachi-Cameco). The cost advantages proclaimed by GLE are exactly those associated with a very small signature for surveillance. Further, the technology is promoted as having other important isotope separation applications, such as silicon, carbon and oxygen, meaning that its development for uranium enrichment in other countries could be “covered” by a need for other useful isotopes. This has led to an active discussion of a fundamental question: does the Nuclear Regulatory Commission need to make a judgment on proliferation risk in considering the license to operate? Slakey and Cohen argue this case, stating that the Atomic Energy Act requires that the NRC judge whether a technology is “inimical to the common defense and security” of the United States, while the applicants note that a proliferation judgment was not rendered in approving a license for a centrifuge plant.<sup>10</sup> The distinction is in the maturity of the technologies, with the laser technology never operated commercially and the centrifuge plant replicating a European design already operated at large commercial scale. There is no question that the technology will remain classified and that high levels of compliance will be sought if the license is issued. The concern is over leakage, as has occurred with the centrifuge technology. But the reality is that the basic technology was developed outside the United States over many years. Many other countervailing factors would need to be considered as well, including the importance for United States nonproliferation policy to regain footing as a global nuclear supplier. The need to consider proliferation issues in NRC deliberations seems obvious, but the conclusions of such deliberations seem much less so and will need to take into account classified specifics of the technology and its history as well as overall United States economic and security factors. Input to the NRC from DOE, State, and the intelligence community is important for any such deliberation.

*An important lesson from this unresolved discussion is that we can expect isotope separation technology to advance. This heightens the importance of moving with more urgency to update the global nonproliferation regime, rather than inevitably being reactive to a yet unknown breakthrough technology.*

## Safeguards

Next generation safeguards are an important part of the response to these challenges. Technology-based safeguards have had a principal focus on timely detection of fissile material theft or diversion from nuclear fuel cycle facilities, complementing physical security and facility inspections. The goal is a sufficiently accurate inventory of fissile materials at each stage of the fuel cycle to enable governments to account for and protect nuclear materials within their borders and to assist the IAEA in its monitoring of international commitments under the NPT. A summary table of technical objectives at various stages of the fuel cycle, taken from a 2005 American Physical Society (APS) report, is shown in Table 8.2.

**Table 8.2 Safeguard Technical Objectives**

ENRICHMENT PLANTS	REACTORS AND FUEL FABRICATION	REPROCESSING PLANTS	WASTE SITES
Detect concealed enrichment plants	Detect concealed production reactors	Detect concealed reprocessing plants	Detect diversion of nuclear material or spent fuel
Detect production of highly enriched uranium or excess amounts of low enriched uranium in declared plants	Detect covert production of nuclear material Uncover diversion of nuclear material from declared inventories	Uncover undeclared use of facilities for separation or purification activities Detect diversion of nuclear material	

Nuclear Energy Study Group of the American Physical Society Panel on Public Affairs. Hagengruber, R. (study chair). (May 2005). Nuclear Power and Proliferation Resistance: Securing Benefits, Limiting Risk. Washington, D.C.: American Physical Society Panel on Public Affairs.

The safeguards technologies resulting from the first generation of robust R&D have now been deployed widely and effectively. However, the array of recent and future challenges has not been addressed with a commensurate response. An important factor is the sheer increase in the IAEA safeguards responsibilities, with many more facilities under safeguards likely in the future and, in the last several years, an order of magnitude increase in the number of Additional Protocol agreements implemented. These are good developments, but technologies are needed that can safely limit the burden of inspections. Introduction of new reactor, reprocessing, and/or enrichment technologies and new large scale fuel cycle facilities, including long term storage sites, will add complexity and new protocols to the IAEA effort. As already noted, the Iran situation has highlighted the importance of detection of undeclared fuel cycle facilities, and the concern about terrorism has heightened the importance of integrated safeguards and security. Yet, modern enabling technologies, such as modeling and simulation and integrated sensor, information, and communications systems, are employed minimally today.

A few of the areas that call for a renewed commitment to safeguards technology R&D include:

- ❑ **Safeguards-by-design:** This entails integration of facility-specific safeguards systems into the early stages of nuclear facility design, for both physical and process configuration, while respecting the imperatives of efficient safe commercial operation. Modeling and simulation will be an essential tool. The Japanese Rokkasho Reprocessing Facility provided a good model for advancing safeguards-by-design.
- ❑ **Real-time process monitoring:** New, faster, and more accurate non-destructive assay in operating plant conditions is a technological challenge. Advanced detection algorithms, such as Bayesian statistics, and diversion pathway modeling (part of safeguards-by-design for new plants) will complement current safeguards for keeping track of fissile materials. For example, at an enrichment plant, enrichment and mass flows will be needed simultaneously for feed, product, and tails streams.
- ❑ **Data integration:** An overall safeguards system will require integration of authenticated heterogeneous data, potentially from hundreds of sources, as the basis for remote facility monitoring. An automated system will alert inspectors to anomalies and potentially initiate physical containment measures autonomously.

- Environmental monitoring: Environmental samples (ground, water, air, surfaces) taken outside the facilities, together with very sensitive analysis of elemental and isotopic composition, are a crucial system element for detection of undeclared facilities. This is technologically challenging, particularly if a large area is to be covered and the host country is not cooperative. Novel communicating sensor networks and small energy sources may be key enablers.

Until recently, the DOE safeguards technology program operated with only a few million dollars per year, incommensurate with the scope and urgency of the challenges and opportunities. The Next Generation Safeguards Initiative (NGSI), begun in 2008, has program plans approaching \$50M/year. This is a more appropriate level, although it must be pointed out that not all of this is directed at next generation technology since NGSI has additional responsibilities (human capital development, international engagement,...). The technology program needs to be built and sustained with the highest priority.

There are considerable technical challenges in development of next generation safeguards for the real world operating environment of fuel cycle facilities. A dedicated and coordinated program of field testing in representative facilities will be required. A variety of commercial and national laboratory facilities can be employed in the United States for demonstrating and refining many of these technologies. Collaboration with international partners for meaningful demonstration projects will also be essential, given the limited number of domestic modern nuclear facilities. *The DOE should develop an open and transparent stakeholder process to provide a safeguards technology roadmap aligned with the challenges of global fuel cycle development.*

## CITATIONS AND NOTES

1. Goddard, B. (Director). (2010). *Nuclear Tipping Point* [Motion Picture]. United States: Nuclear Security Project.
2. Jones, Rodney and Mark McDonough. *Tracking Nuclear Proliferation: A Guide in Maps and Charts, 1998*. Washington, D.C., Carnegie Endowment for International Peace. 1998.
3. The Los Alamos Primer, R. Serber, University of California Press, 1992)
4. A dirty bomb consists of a radioactive source and a conventional explosive where the goal is to disperse radioactivity. It is not a nuclear weapon and there is no nuclear yield. The radioactive material does not have to be fissionable (e.g., cobalt-60, used widely for industrial gamma ray sources).
5. Bunn, Matthew. *Securing the Bomb 2010*. Cambridge, Mass. and Washington, D.C.: Project on Managing the Atom, Belfer Center for Science and International Affairs, Harvard Kennedy School and Nuclear Threat Initiative, April 2010.
6. McGoldrick, F. (2011). *The Road Ahead for Export Controls: Challenges for the Nuclear Suppliers Group*. Washington, D.C.: Arms Control Today, January/February 2011. [http://www.armscontrol.org/act/2011\\_01-02/McGoldrick](http://www.armscontrol.org/act/2011_01-02/McGoldrick), accessed January 13, 2011.
7. Deutch, J. et al. (Winter 2004-2005). Making the World Safe for Nuclear Energy *Survival*, 46, (4), 65-80.
8. McGoldrick, F. (November 30, 2010). The U.S.-UAE Peaceful Nuclear Cooperation Agreement: A Gold Standard or Fool's Gold? In *Policy Perspectives* Washington, D.C.: Center for Strategic and International Studies.
9. Deutch, J. et al. (Winter 2004-2005). Making the World Safe for Nuclear Energy *Survival*, 46, (4), 65-80.
10. Slakey, F. and L. Cohen. (March 4, 2010). Stop laser uranium enrichment. *Nature*, 464 (7285), 32-33.



# Chapter 9 — American Attitudes about Nuclear Power and Nuclear Waste<sup>1</sup>

Public attitudes toward nuclear power have shaped the federal and local policies concerning siting and construction of new nuclear plants and the development of interim and long-term waste storage facilities. The collapse of public support nationwide for nuclear power following Three Mile Island as well as local opposition to specific facilities is one factor contributing to the weak growth in this industry over the past 30 years.

Since 2002, the MIT energy studies have gauged public understanding of and attitudes toward nuclear power and other energy sources. These studies are random sample surveys of adults in the United States, conducted in 2002, 2003, 2006, 2007, and 2009, over the Internet by Knowledge Networks. The 2002 and 2007 surveys go into the greatest depth about nuclear power and more extensive analyses of these surveys as well as data are available through the MIT CANES<sup>2</sup> and MIT Political Science Department<sup>3</sup>. The 2007 study replicates much of the 2002 survey, which is presented in the report *The Future of Nuclear Power*. The 2009 survey contains a smaller battery of questions focused on waste disposal and to get the most current reading on attitudes toward construction of new nuclear plants. These surveys replicate questions asked by earlier surveys, some dating as far back as 1973. This allows us to extend the time series of public opinion surveys on nuclear power, especially questions concerning waste, safety, and expansion of nuclear power. In addition, the surveys include new items in order to examine the bases for public support.

Of particular interest is whether growing concern about global warming might lead to greater support for nuclear power. Addressing this question requires including measures of concern about global warming as well as support for nuclear power in the same survey as well as measures of other concerns that might explain the overall attitude an individual has toward nuclear power. These other factors include cost of electricity production using nuclear power, possible local environmental risks, likelihood of an accident, and concerns about waste storage. This chapter focuses on what these surveys reveal about overall support for nuclear power and its connection to public concern about waste storage.

## **SUPPORT FOR BUILDING NEW NUCLEAR POWER PLANTS**

To begin with, some background. A series of public opinion surveys establish a clear trend of declining public support for building additional nuclear power plants from the mid 1970s through 2000. The surveys were conducted by various organizations<sup>4</sup>, especially Cambridge Energy Research Associates (CERA) and Gallup, asking the question “Do you support or oppose building new nuclear power plants?”<sup>5</sup> The trend shows a precipitous drop in sup-



port for nuclear power over the period 1975 to 1985. By 1990, a large majority expressed opposition to the construction of nuclear power plants. This trend, if continued, would raise an immediate policy question, because, as the original report *The Future of Nuclear Power* projects, the United States may need to build an additional 300 to 400 power plants over the coming decades.

Between 1990 and 2000 very few survey organizations asked this question. The MIT Surveys begin in 2002 and were repeated in 2007 and show a public more evenly split about nuclear power, compared to the surveys in 1990. The 2009 MIT Energy Survey found markedly higher support for nuclear power than in previous surveys. Fully 61% of the 1,289 respondents said they favored building new nuclear power plants in the United States. One possible explanation is the 2008 presidential campaign, in which Republican-nominee John McCain called for a significant expansion in the number of nuclear power plants, especially during debates, and Democratic-nominee Barack Obama offered no immediate objection.

The 2002 and 2007 surveys asked a somewhat different question than had surveys in the previous century. Specifically, the surveys asked whether the U. S. ought to expand or reduce the use of nuclear power. The question allowed people to also indicate whether they would like to increase or reduce the use of nuclear power, keep it the same, or not use it at all. In addition to nuclear power, the survey asked respondents' attitudes toward six other power sources: coal, natural gas, oil, hydroelectric, solar, and wind.

**Do you think the U.S. should reduce or increase its use of nuclear power?**

	2002	2007
Increase	28%	34%
Not Change	25%	25%
Reduce	38%	29%
Not Use	9%	12%

Comparison of the 2002 and 2007 surveys show a 6 percentage point increase in those supporting an increase in nuclear power and a similar drop in the ranks of those who want to reduce or eliminate the power source. However, asking this more refined version of the question also reveals that those who want to reduce or eliminate nuclear power still outnumber those who want to increase it but the trend is increasingly positive to new nuclear plants.

There does, then, appear to be indications of rising support for the expansion of nuclear power. Given the different levels of support indicated by different question wordings suggests that no single question may be ideal, and instead survey research in the future ought to employ multiple measures and ought to continue past measures, for which there is a ready basis for comparison.

**OPINIONS ABOUT NUCLEAR WASTE**

Waste is a critical lynch pin in further development of nuclear power.

Toward the end of the 2007 study, the survey asked respondents if the nuclear waste problem was solved would they support expansion of nuclear power. 51 percent said that they

would, compared to 34 percent who said that they favored an increase in nuclear use in the United States.

The problem is that most Americans do not think that such a solution is currently available.

The 2002 and 2007 MIT surveys carried a simple question about waste storage that had been employed occasionally in earlier surveys. Specifically, “Do you agree or disagree with the following statement? Nuclear waste can be stored safely for many years.”

Of those with an opinion, 36 percent agreed with the statement and 64 percent disagreed in 2002. That percentage fell somewhat by 2007, with 31 percent agreeing with the statement and 69 percent in disagreement. Opinions about the safety of waste storage, in turn, predict support for construction of additional nuclear plants. In multivariate analyses, opinions about waste storage had stronger effects on attitudes toward construction of additional power plants than any other factor except for price and local environmental risks.

A large majority of Americans remain skeptical about waste storage, and that skepticism, as well as concerns about cost and local environmental impacts, dampens support for expanding the use of nuclear power in the United States.

## ATTITUDES ABOUT INTERIM WASTE STORAGE

Waste storage raises immediate policy questions, especially about the development of an interim facility. Public opinion may offer some guidance as to how the United States should proceed with interim waste storage, quite apart from general opinions about waste or about the feasibility of long-term waste storage. Importantly, public opposition to the Yucca Mountain facility in the state of Nevada and in national polling has helped justify delay in the development and deployment of that waste storage site.

The MIT Surveys in 2009 and 2007 examined public opinion on two facets of waste storage policy: (1) storage at power plants versus a central facility, and (2) Yucca Mountain.

The 2009 survey explored the question of central versus decentralized interim storage directly. The question was designed to capture the realistic policy alternatives of continuing above ground storage at existing power plants or storing at a central facility underground, without mentioning Yucca Mountain. Other waste storage concepts are possible, but as yet they are just concepts.

*Nuclear power plants produce a small amount of highly dangerous radioactive waste. Before waste can be put in permanent storage it must be stored at an interim facility for several decades. Waste from existing nuclear power plants is kept above ground at the power plants. How do you think the U. S. should store this waste?*

At nuclear power plants, above ground	15%
At a single central storage facility, underground	23%
Not Sure	61%

Those Americans who have an opinion on the matter were somewhat more likely to favor underground storage at a central facility over above ground storage at power plants. But the survey gives little encouragement to those supporting such a centralized facility. The majority of survey respondents has no opinion or is not sure. As the public learns more on this issue, opinions may shift in either direction or toward some alternative.

The policy debate over waste storage in the United States over the past two decades has focused on one facility, that in Yucca Mountain, Nevada. On this matter Americans had more definite opinions and their attitudes offer some insight into the politics of the matter. The question developed for this purpose attempted to capture one of the most important features of the current political situation with regard to the Yucca Mountain facility, namely, the emergence of political opposition within the state. Opposition within the state has delayed the deployment of the facility and may lead it to be shelved permanently. The survey reveals that local consent may be pivotal in the nation's thinking about this (or another facility) as well.

*If the Nuclear Regulatory Commission approves the license of the Yucca Mountain nuclear waste storage facility, do you think the United States should use this facility?<sup>6</sup>*

	2007	2009
Yes, definitely	18%	24%
Yes, only if the state of NV agrees	24%	29%
No, find another facility	12%	2%
No, we shouldn't have such a facility	18%	11%
Not Sure	27%	34 %

Public opinion on Yucca Mountain is more clearly formed than it is about the general approach to waste storage. Although the percentage of people who say they are Not Sure remains sizable, it is much lower than with an abstract waste storage facility.

In both surveys a plurality of respondents support the deployment of the Yucca Mountain facility. 42 percent expressed at least provisional support in 2007 and 53 percent expressed provisional support in 2009. By contrast 30 percent opposed the facility in 2007 and 13 percent opposed it in 2009. Part of the change may reflect the question wording, which was adapted to the changing administrative situation. In the middle of 2008, the DOE filed the application to begin deployment of the project, and the preamble to the 2009 question reflected the fact that the NRC was considering that license.

Even if the NRC approved the license, obtaining majority support for the project still depended on one key condition – assent from the state of Nevada. 29 percent would support deployment of the Yucca Mountain facility only if the state of Nevada were to also improve. A similarly large fraction expressed the same view in 2007.

This finding indicates that any federal effort must work hand-in-hand with the states and be structured to obtain local support first and maintain that support through to the deployment of the facility.

## ATTITUDES ABOUT GLOBAL WARMING AND NUCLEAR POWER

Growing concern about carbon emissions from fossil fuels and global warming may bolster public support for nuclear power as an option, just as concerns about waste storage have acted as a drag. The potential connection between carbon emissions and climate change motivated the original MIT Study on the Future of Nuclear Power. And, since that time, there has been growing international and national focus on climate change and the possible contribution of nuclear power to the reduction of carbon emissions. Expert judgments concerning global warming are increasingly used to justify the expansion of nuclear power as part of national climate policy.

The connection between expanding nuclear power and reducing carbon emissions is not, however, so clear among the American public.

The 2002 and 2007 MIT surveys found no evidence that public concern about carbon emissions and climate change translates into higher levels of support for nuclear power. The surveys asked about concern about global warming using a variety of questions, including identification of global warming as an important environmental problem, statements of concern about global warming, and willingness to pay higher electricity bills to lower carbon emissions. The surveys also asked about willingness to expand the use of nuclear power. In the 2002 and 2007 surveys, there was either no or a negative correlation between respondents' degree of concern with global warming and their support for expansion of nuclear power. That was true for simple correlations and partial correlations, holding constant demographic characteristics of individuals and understanding of and attitudes about energy and environmental issues. This lack of correlation suggests that if people become more concerned about climate change, we do not expect public support for nuclear power to change as well.

The 2003 MIT energy survey reveals that the reason may lie in public impressions about nuclear power. In that survey approximately half of the people stated that nuclear power was a substantial contributor to carbon emissions.

The 2009 survey asked people directly about their willingness to trade off global warming risks against nuclear power risks. Specifically, the survey asks:

*Nuclear Power plants produce little or no greenhouse gases, such as carbon dioxide. Should the U.S. expand the use of nuclear power as a means of reducing the risks of global warming?*

Expand nuclear power to lower carbon emissions.	36%
The risks associated with nuclear power are too great, even though global warming is a serious problem.	25%
The risks of global warming are exaggerated and do not justify the use of nuclear power.	15%
The risks of global warming are exaggerated but I'd like to see more nuclear power for other reasons.	23%

While the modal response was to say that the risks of global warming justify the expansion of nuclear power, that group was far from a majority of respondents. A majority did chose options favoring the expansion of nuclear power, but that coalition consists of those

who are very concerned with global warming and therefore support nuclear power (and, incidentally, tend to favor environmental protection over economic growth) plus those who think the risks of global warming are exaggerated but who also favor nuclear power. The pro-nuclear coalition, then, consists of groups who normally find themselves at odds.

These responses to this survey also offer insight into the potential connection between concern about global warming and support for nuclear power. The response to the above question may be thought of as capturing two variables, willingness to use nuclear power and concern about risks of global warming. Respondents are asked to weigh each and reveal how they would trade off one risk against the other. An alternative representation of the responses to the above question, then, is as two-by-two table. The first cell of the table corresponds to those who would like to use nuclear power and who think the risk of global warming is very high; the second cell consists of those who do not think global warming presents a high risk and would like to expand nuclear power regardless; and so on.

*Implied Relationship between Global Warming Risk and Willingness to Use Nuclear Power.*

		GLOBAL WARMING RISK	
		HIGH	LOW
Nuclear Use	Yes	36%	23%
	No	25%	15%

A standard chi-squared test reveals that one cannot reject the hypothesis that the two variables in the table are statistically independent. That is, the likelihood of supporting nuclear power is approximately the same among those who said that global warming presented a high risk and those who did not. If public understanding of these two issues remains the same, then increasing concern about global warming will not lead directly to increased support for nuclear power. Support for nuclear power might be indirectly tied to climate change, as the climate issue may alter elite discourse about energy policy and, in turn, public opinions. However, over the past 7 years we have seen little evidence that those who are more concerned about global climate emissions are more likely to support nuclear power. A connection might be established with increased public understanding of the comparative carbon emissions of fossil fuels and of nuclear power.

**CITATIONS AND NOTES**

1. Prepared by Stephen Ansolabehere, sda@gov.harvard.edu.
2. <http://mit.edu/canes/publications/programs/nes.html>
3. <http://web.mit.edu/polisci/portl/index.html>.
4. The results of earlier polls and trends are reviewed by Eugene A. Rosa and Riley E. Dunlap, "Nuclear Power: Three Decades of Public Opinion Trends," *Public Opinion Quarterly* 58 (1994): 295.
5. The Nuclear Energy Institute's surveys ask somewhat different questions, especially whether the respondent supports nuclear power, period, or expansion of capacity at existing facilities.
6. The wording in 2007 was slightly different as reflected the changing regulatory circumstances. "The United States is developing a nuclear waste storage facility in Yucca Mountain, Nevada. Do you think the U.S. should complete and use this facility?"

# Chapter 10 — Recommended Analysis, Research, Development, and Demonstration Programs

Our analysis of the future of the nuclear fuel cycle has been carried out in the context of a potential global nuclear power deployment over this century on a much larger scale than is the case today. Stringent limits on CO<sub>2</sub> emissions would greatly enhance the importance of nuclear power as a large-scale alternative to fossil fuel combustion. Our recommendations are geared towards enabling nuclear power as a viable marketplace option.

## CRITERIA AND GOALS

Analysis, research, development, and demonstration (ARD&D) must play an important role if nuclear power is to be economically competitive while further enhancing safety performance commensurate with an order of magnitude larger deployment, addressing waste management challenges in a scientifically grounded manner that provides public confidence, and mitigating nuclear proliferation risks associated with fuel cycle development globally. The ARD&D priorities should be driven by the strategic needs identified throughout our study. The ARD&D program goal is to provide the technical basis for critical decision points in fuel cycle development, choices that have multi-decadal implications. Multiple technology options call for R&D prior to making very expensive large-scale demonstration decisions that lock in fuel cycle development pathways. A disciplined ARD&D program aligned with strategic objectives will be a necessary condition for stability over the decadal time scale needed for major progress in the nuclear reactor and fuel cycle domain.

The results of our analysis that underpin the ARD&D recommendations include:

- ▣ There is ample affordable uranium for nuclear power expansion throughout this century.
- ▣ LWRs will be the workhorse of the nuclear fleet for decades.
- ▣ Long term storage of irradiated LWR fuel, with a century planning horizon, is the preferred approach. This can be done safely at the reactor, a centralized facility, or in a repository that allows future spent nuclear fuel retrievability.
- ▣ Geological isolation of SNF and/or HLW will ultimately be employed and is scientifically sound.
- ▣ Waste management will be facilitated by better classification of all waste streams and by development of waste forms tailored to the disposal pathway.

- ❑ Waste management must be integrated with the design of the fuel cycle. This creates new options such as partitioning/reprocessing of irradiated fuel that may enhance waste management and public acceptance.
- ❑ There are multiple options for advanced reactor/closed fuel cycle choices, and these options need research and analysis that enables timely marketplace decisions.
- ❑ End-to-end nuclear fuel cycle costs must be competitive with the future costs of other low-carbon options if deployment is to scale appreciably.
- ❑ Institutional and technical advances are needed to minimize fuel cycle proliferation risks.

**Table 10.1 Fuel Cycle Objectives and Potential RD&D Implications**

OBJECTIVES	POTENTIAL IMPLICATIONS
Economics	<ol style="list-style-type: none"> <li>1. Reactor life extension beyond 60 years (may be lowest cost option)</li> <li>2. High efficiency reactors</li> <li>3. Advanced technologies for LWRs with enhanced performance, thus building upon existing industrial base</li> <li>4. Modular reactors for specialized markets, more favorable financing conditions, or industrial heat (displacing fossil fuels).</li> <li>5. Efficient regulatory process for a wider class of reactors than large LWRs</li> </ol>
Safety and Security	<ol style="list-style-type: none"> <li>1. Super fuel forms that withstand severe conditions with reduced safety challenges for reactors (but make recycle more difficult)</li> <li>2. Wider use of information technology for plant safety and operations</li> <li>3. Coupled reprocessing-repository facilities to reduce process risks</li> </ol>
Waste Management	<ol style="list-style-type: none"> <li>1. Tailored waste forms/ advanced fuel designs for disposal</li> <li>2. Special management of actinides or long-lived fission products Novel separations with waste stream minimization Transmutation—waste destruction Borehole disposal</li> <li>3. Repository with multi-century retrievability</li> <li>4. Collocated fuel cycle facilities to maximize local benefits</li> </ol>
Resource Availability & Utilization	<ol style="list-style-type: none"> <li>1. Uranium resource assessment</li> <li>2. Uranium from seawater</li> <li>3. Fast spectrum reactors with open, modified, or closed fuel cycle</li> <li>4. Repository with retrievable SNF</li> </ol>
Non-proliferation & Safeguards	<ol style="list-style-type: none"> <li>1. Avoidance of high-enriched uranium and separated plutonium e.g., Fast reactors fueled with natural uranium after startup/no reprocessing</li> <li>2. Borehole disposal of TRU</li> <li>3. Advanced safeguards</li> </ol>

Each of these defines part of the overall high-priority RD&D agenda. A high level summary of some of the implications is provided in Table 10.1.

The very limited amount of fuel cycle R&D carried out in the U.S. over the last quarter century has centered on technology pathways established early in the nuclear power development program (see Appendix E). In moving forward, a broader set of options needs to be explored in the spirit of technology tradeoffs within multi-objective fuel cycle design.

## RD&D TO SUPPORT RECOMMENDATIONS

A robust RD&D program will need three components: research and development, supporting research and testing infrastructure, and demonstration projects. Key areas that have seen serious underinvestment include: RD&D for enhanced LWR capability; RD&D for spent fuel storage and waste disposal; R&D for innovative nuclear energy applications and concepts; and development of advanced modeling and simulation tools to underpin analysis of technology options. Our recommendations for key R&D program elements are:

*Uranium resources.* The fuel cycle assumption in the 1960s and 1970s was that uranium resources were limited; thus, one must choose fuel cycles to maximize efficient use of uranium. Our analysis concludes that this assumption is incorrect and there are sufficient uranium resources at economic prices for the large growth of nuclear power. Because uranium resource estimates are central to fuel cycle choices, we recommend that the United States should initiate an international R&D program to provide higher confidence in long-term uranium resource supply curves.

The goal of such an international program is to improve our understanding of global uranium mining costs versus cumulative production. This should include the implications of newer mining technologies such as in-situ uranium recovery, understanding at what costs technologies such as seawater uranium might effectively cap uranium costs, and methods to estimate lower-grade resources between those of commercial interest today and uranium from seawater.

The last such global uranium assessment was completed in the early 1980s. Since then there have been major advances in technology and our understanding of uranium geochemistry. We recommend a program of \$20 million per year for 5 years as part of a globally coordinated uranium assessment.

*LWR Enhanced Performance.* LWRs are the only commercial reactors used today in the United States. The historical record shows that it took the United States several decades to develop, deploy, and learn to efficiently operate LWRs. Our dynamic systems modeling show that LWRs will likely be the dominant reactor type for much of this century. If there are to be major improvements in relatively short time frames in nuclear power economics, safety, waste management, resource utilization, or proliferation resistance, new technologies must be developed for both new and existing LWRs.

Appropriate RD&D activities include enhanced performance and life extension for existing LWRs, new build LWR technology (new materials, advanced fuel clad such as SiC, etc.), and advanced fuel development through lead reactor fuel test assemblies. There is the potential for transformational technologies including new fuels that would result in major increases in safety margins and improved repository performance, the potential for higher thermal efficiency (40+%) LWRs, and LWR variants with the capability for sustainable closed fuel cycles and for efficiently burning selected radionuclides. We recommend an RD&D expenditure of \$150 million per year. As technologies approach deployment, the development and demonstration programs should be jointly funded programs with industry to assure the commercialization of such technologies.

*SNF/HLW Management.* We recommend long-term SNF storage (at reactor, centralized storage facility, or a repository that allows future SNF recovery) to (1) maintain fuel cycle



options because we do not know today if LWR SNF is a waste or a resource and (2) reduce repository costs and performance uncertainties through aging of SNF to reduce its decay heat.

A geological repository is required independent of the choice of fuel cycles, and we recommend expeditious movement toward siting, licensing, and construction of one or more repositories. We have also recommended major technical and institutional changes in the U.S. waste management program and have noted that the most successful waste management programs have developed multiple options that reflect both technical and institutional requirements of repository siting—including public acceptance.

An R&DD program is required to support these recommendations. R&D is needed to provide high-confidence in very long term SNF storage and the ability to transport SNF after storage. Storage R&D will be needed for new fuels and SNF with higher burnups. R&D is needed to create new waste management technical and institutional options (borehole, partitioning for waste management, co-sited and integrated repository/reprocessing fuel cycles). Existing options should be improved (enhanced waste forms and engineered barriers). Research will also be required to support development of a risk-based waste classification system as part of the regulatory structure for waste disposal. We recommend a waste management R&DD program of \$100 million/year.

*Closed Fuel Cycles and Fast Reactors.* Historically closed fuel cycle and fast reactor programs were based on two technical assumptions that drove fuel cycle decisions: (1) uranium resources are very limited and (2) a fast reactor with a very high conversion ratio ( $CR > 1$ ) is required to extend uranium resources. Improved understandings of uranium resources and new dynamic simulation tools have led us to the conclusion that both assumptions are false. Reducing these technical constraints opens up a much broader set of fuel cycle options that can better meet multiple fuel cycle goals.

Simultaneously, new technologies (hard-spectrum light water reactors, fast reactors with once-through fuel cycles, integrated reprocessing-repository facilities, novel separations technologies) and optimization for lower conversion ratios have created potentially a much wider set of viable fuel cycle options with potentially better economic, nonproliferation, and waste management characteristics.

This leads to the R&D recommendation for a program to understand and evaluate the wider set of options based on multiple criteria. A focused multiyear analysis and experimental program is recommended to understand the options, determine viability, define the time lines for development, and down-select to a short set of options before choosing a long-term fuel cycle strategy. This will require advanced fast reactor concept analysis; simulation; experiments to address key uncertainties; basic science and engineering; new separations and analysis; and safety and operations analysis. For many options, only a limited number of technical questions (requiring experiments and analysis—Appendix B) must be addressed to narrow the choice of options to a manageable number. A multiyear R&D program (\$150 million/year) is recommended.

*Modeling and Simulation.* A major constraint for nuclear energy has been the long development cycles associated with new technologies relative to other energy technologies. This is partly a consequence of the need for long-term tests of the behavior of materials in radiation environments. Radiation damage determines the technical limit of how long a fuel

assembly or other component can remain in a reactor core until its physical properties degrade. Radiation damage from radioactive decay can determine the long-term behavior of a waste form in a repository. The historical strategy to improve materials is to develop a new material, irradiate it, and test its properties. After several cycles of development and testing, an improved material is developed. This strategy has almost tripled the lifetime of nuclear fuel assemblies in today's LWRs. However, as the technology improves the R&D time required for the next advance increases because of the longer irradiation times needed to support goals of developing longer lived materials. The same challenge exists for space nuclear power systems where the decade-long missions creates major challenges to test materials for the required times. New R&D strategies are needed.

Advances in modeling and simulation of materials and systems (with supporting experimental work to confirm models) have begun to result in tools that may be able to dramatically shorten development cycles (such as fewer cycles of test irradiations), enable better understanding of options, and reduce costs<sup>1,2</sup>. This cross cutting R&D benefits all nuclear research. Such technologies may enable the U.S. to examine a broader set of options and understand implications before making major fuel cycle decisions. The recently launched DOE innovation hub (Center for Advanced Simulation of Light Water Reactors) with a focus on modeling and simulation to enhance LWR performance is a good start. Modeling and simulation at the extreme scale can also accelerate licensing of new technologies by developing and employing new methods for risk quantification<sup>1</sup>.

Modeling and simulation at the system level will underpin a new analysis regime for guiding fuel cycle decisions addressing multiple objectives.

An R&D budget of \$50 million per year is recommended.

Ultimately there is no substitute for testing to validate or disprove the conclusions of simulations. The testing time frames are long and thus the need for long-term research programs with appropriate irradiation facilities to create long-term fuel cycle options (see below).

*Novel Applications and Innovative Concepts.* This study focuses on actions that can enable scaleup of nuclear power as a response to carbon emissions constraints. Today nuclear reactors are used for the production of base-load electricity; however, base-load electricity is less than a third of the total energy market. New nuclear technologies such as high-temperature reactors, small reactors, and hybrid energy systems (nuclear-renewable systems for electricity and liquid fuels production, nuclear-geothermal energy storage systems, etc.) could contribute to a total low-carbon energy system. Such nontraditional uses of nuclear energy imply modifications to the nuclear technologies and development of specialized non-nuclear technologies.

There is a need to explore innovative concepts more robustly. We identified new potentially attractive nuclear technology options (Appendix B)—including advanced reactor concepts that did not exist three decades ago and innovations (primarily in materials) that may change the viability of old technologies. A peer-reviewed competitive program should be the centerpiece of an R&D program for novel concepts. We recommend an R&D program of \$150 million per year to address these new applications and innovative concepts.

*Nuclear Security.* Nonproliferation is fundamentally an institutional challenge, but next generation technical safeguards are an important complement. Such technologies can both enable international nonproliferation agreements and provide confidence in compliance.

The commercial fuel cycle is one of several possible routes to nuclear weapons. To support fuel cycle nonproliferation efforts, we recommend an R&D program of \$50 million per year in advanced safeguards technologies. The goal is nuclear materials containment, surveillance, security and tracking focused on the commercial fuel cycle. Technologies such as safeguards-by-design, real-time process monitoring, data integration, and environmental monitoring are examples of areas requiring more focus. This safeguards R&D program should be complementary to the larger effort focused on all aspects of nonproliferation and continue to be supportive of International Atomic Energy Agency safeguards programs.

While the nuclear security budget is normally described in terms of technical safeguards, other R&D activities that we recommended above support this national security mission. Perceptions of uranium resources drive many fuel cycle decisions. Understanding uranium resources can place fuel cycle decisions and the associated safeguards decisions on a stronger foundation. Development of alternative waste management options such as borehole disposal may provide SNF disposal options for the U.S and be suitable for countries with smaller nuclear energy programs—with the potential benefit of better meeting nonproliferation objectives. There are repository options that would make plutonium recovery much more difficult. Some types of SNF are significantly less attractive as a source of fissile material in the context of nonproliferation (Appendix C). If the United States is to influence

**Table 10.2 Summary of R&D Recommendations**

ITEM	\$ 10 <sup>6</sup> PER YEAR	EXPLANATION
Uranium Resources	20	Understand cost versus cumulative world production
LWR Nuclear Power Reactor Enhanced Performance	150	Enhanced and life extension for existing LWRs New build LWR technology (New materials, fuel clad, etc.) Advanced fuel development through lead test assemblies
SNF/HLW Management	100	Dry cask storage life-extension Deep borehole and other disposal concepts Risk-based waste classification system Enhanced waste forms/engineered barriers
Fast reactors and closed fuel cycles	150	Advanced fast reactor concept analysis and experiments, simulation, basic science, engineering, and cost reduction New separations and analysis Safety and operations analysis
Modeling and Simulation	50	Advanced nuclear simulation innovation; Advanced materials for nuclear applications
Novel Applications and Innovative Concepts	150	High-temperature reactors; Modular reactors; Hybrid energy systems (nuclear-renewable-fossil options for liquid fuels, industrial heat). Peer-reviewed, competitive program for novel concepts.
Nuclear Security	50	Advanced safeguards for commercial fuel cycles Nuclear materials containment, surveillance, security, and tracking technologies

worldwide choices of closed fuel cycles, being a knowledgeable participant in the development of those fuel cycle technologies is an important facilitator. Such R&D should be integrated with those for SNF/HLW management, closed fuel cycles and fast reactors, and novel applications and innovative concepts, exploiting the cross-cutting connections.

This total R&D program will require an investment of about \$670 million per year; a rough breakout is suggested in Table 10.2. The Department of Energy R&D planning<sup>3</sup> has moved towards closer alignment with these recommendations.

To carry out the R&D program effectively, much of the supporting R&D infrastructure must be established<sup>4</sup>. To support R&D for new reactors and fuel cycles, facilities will ultimately be required with special test capabilities. Examples include fast neutron flux materials test facilities, fuel examination facilities, fuel-cycle separations test facilities, and facilities for novel nuclear applications (hydrogen production, heat transport to industrial facilities, etc.). Some of these facilities are billion-dollar (or more) facilities—separate from the R&D expenditures listed above. A structural investment on the order of \$300 million per year will be required for a decade or so to begin to make a significant difference.

In addition to the traditional infrastructure facilities, we recommend a transuranic/SNF user facility to better utilize investigator-initiated research capabilities of universities to support national needs and provide the skilled R&D workforce needed to support nuclear power, nonproliferation, and national security missions. Such a facility requires glove boxes and hot cells, health and safety support infrastructure, and the required security to enable research with significant quantities of transuranic elements, SNF, and other radionuclides. Facilities within traditional national laboratories structures have not been able to meet this need because priorities have been given to programmatic and national security missions with associated secrecy requirements. Such a user facility would be similar to other user facilities (Spallation Neutron Source, Advanced Photon Source) supported by the DOE Office of Basic Energy Science and the National Science Foundation. Such user facilities have been created elsewhere in the world, such as the Institute of Transuranic Elements (ITU) in Germany—a European Community user facility for researchers across Europe.

Last, to support commercial viability of new types of advanced reactors and associated fuel cycles, demonstration projects are ultimately required. Such demonstration projects should be joint government-industrial programs and may involve investments of several billion dollars. This is the most difficult step in the development and deployment of new technologies where the U.S. has traditionally had great difficulties. There will be relatively few demonstration projects. The highest priority choices will emerge in time given the R&D program outlined above. These choices should be made with the view toward supporting licenseability of economically viable new technologies. Examples of possible demonstration projects include high-temperature reactors, hard-spectrum light-water reactors, and liquid-metal-cooled fast reactors. International collaboration should be considered for such projects to expand the set of options that can be investigated.

Licensing is one of the major challenges in the commercialization of new nuclear technologies. Demonstration that the technology meets safety and environmental requirements is central. The federal government should explore ways to reduce the time and cost of licensing new technologies using a risk-based technologically-neutral licensing framework<sup>5</sup> and consider assistance to overcoming this commercialization barrier.

There have been major changes in our understandings of fuel cycle constraints (larger uranium resources, conversion ratio of one for sustainable reactors,...), goals have changed, and new technologies (Appendices B and C) have been developed. These factors have expanded fuel cycle options and provide us with choices that we did not previously have. However, there has been little examination of fuel cycle options for several decades. Because of the large resources required to develop and implement alternative fuel cycles and national impacts, there are large incentives to examine options before making multi-decade decisions. The central objective of the proposed RD&D program is to provide the information to make informed choices in the available time.

## ORGANIZATION OF RD&D

There are major roles for government and private industry. Much of the RD&D and most of the major infrastructure facilities support multiple government missions. Irradiation test facilities and fuel examination facilities are required for nuclear power, naval propulsion, and space nuclear power. Fuel cycle infrastructure facilities support non-nuclear-power nonproliferation programs. Major infrastructure facilities typically last for decades and will support different national missions over time as they have done in the past.

Nuclear energy R&D has been primarily funded by the Department of Energy (DOE) and its predecessor organizations, Energy Research and Development Administration (ERDA) and the Atomic Energy Commission (AEC). Several offices have supported R&D relevant to the nuclear fuel cycle:

- DOE-NE – reactor and fuel cycle development
- DOE-EM – defense waste (but many technologies applicable to commercial fuel cycles)
- DOE-RW – SNF-HLW disposal (now merged into NE)
- DOE-NNSA – non-proliferation
- DOE-OS – scientific knowledge

The integration of DOE-RW (waste management) into DOE-NE (fuel cycle) is a step in the right direction for R&D. In addition there are a number of agencies responsible for regulatory oversight: NRC, EPA and state agencies. Some of these agencies have their own needs for nuclear research and development, most specifically safety-related R&D supported by the NRC. Within the DOE management structure, R&D is distributed across National Laboratories, as well as universities and industry. Another complication is that these laboratories have stewardship by different DOE offices (NE, EM, Science and Defense Programs), with different priorities with respect to facilities maintenance and development. *DOE needs to develop a coherent plan and management structure for fuel cycle RD&D, including development and maintenance of the critical research infrastructure.*

The recently published DOE-NE research and development roadmap<sup>3</sup> addresses the key challenges to increase the use of nuclear energy both domestically and internationally, with one of its objectives being the development of sustainable nuclear fuel cycles. It has a strong focus on improving LWR systems and is a start in the right direction. The roadmap identifies areas where enabling technologies need to be developed, but the specific tasks related to the development of these enabling technologies are not defined.

## Advanced Technology Opportunities

The United States has not made significant investments in understanding fuel cycle options for several decades. In this time new options (Appendix B) with potentially better characteristics but major uncertainties have been partly developed. Several of these are described here.

**LWRs with modified cores.** The appeal of liquid-metal cooled fast reactors (LMFRs) is that they enable a closed fuel cycle that extracts 50 times as much energy from uranium as does the once-through (open) fuel cycle of existing LWRs. But demonstration LMFRs to-date have been more expensive compared to existing light water reactors (LWRs) and so have never been commercialized. The sodium fast reactor was chosen in the 1970s as the preferred sustainable reactor because of its high conversion ratio. Our analysis indicates that a lower conversion ratio near unity is preferable for a sustainable reactor. Advances in the design now indicate that a hard-spectrum LWR could have a conversion ratio near unity and be a sustainable reactor. Such modified-core LWRs are likely to be less costly to develop than LMFRs, because only the reactor core needs to change, and may be more economic to operate. Moreover, this approach may provide the option of using some of the existing reactor fleet for a closed, sustainable fuel cycle that would greatly extend uranium resources. There has been significant work in several countries on such modified-core LWRs, but additional research and demonstration would be required to determine commercial viability.

**Advanced High-Temperature Reactors.** In the last decade, a new reactor concept has been proposed that uses liquid fluoride salts as coolants and graphite-matrix coated-particle fuel. The reactor combines the coolant developed for molten-salt reactors and the fuel developed for gas-cooled high-temperature reactors. One variant uses pebble-bed graphite-matrix coated-particle fuel. With this option, the fuel pebbles would not be fixed in place as with a conventional fuel assembly, but would slowly move through the reactor core. This allows continuous re-fueling and three dimensional optimization of the reactor over time, en-

abling novel fuel cycles. For example, such a reactor may be operated in a combined uranium-thorium fuel cycle in a once-through mode or may have a high conversion ratio (near unity) if operated with a closed fuel cycle. The reactor would operate at low pressures and with high coolant temperatures resulting in increased efficiency of electric power generation. Thus such reactors could have lower capital costs and enhanced safety and nonproliferation characteristics relative to LWRs. RD&D would be needed to determine long-term commercial viability. This reactor is also called the fluoride salt high-temperature reactor.

**Uranium from Seawater.** Seawater contains about four billion tons of uranium, enough to support thousands of reactors for thousands of years. Recent Japanese research suggests that the cost of obtaining uranium from seawater may ultimately be low enough to be commercially feasible, which would enable once-through fuel cycles for centuries. The economic viability of this option depends upon the long-term durability in seawater of the ion exchanger that is used to separate uranium. R&D is required to determine the potential for seawater uranium.

**Nuclear renewable futures.** Historically, nuclear energy has been considered as a source of base-load electricity, which constitutes a quarter to a third of the world's total energy needs. However, there are additional candidate markets, such as meeting peak and other variable electricity demands by coupling base-load nuclear reactors to huge energy storage systems, or production of renewable liquid fuels in nuclear-powered biorefineries. Viability depends upon both the economics of nuclear power and successful development and commercialization of technologies such as gigawatt-year heat storage, high-temperature electrolysis for hydrogen production, and hydrocracking of lignin. Developments in this area could significantly expand low-carbon energy options for the United States and may drive market requirements (temperature of delivered heat, reactor size, etc.) that, in turn, would drive reactor and fuel cycle decisions.

There are large financial and policy incentives for cooperative international programs where different nations build different research infrastructure facilities with agreements for long-term sharing. It would enable the U.S. and others to examine multiple fuel cycle options through demonstration projects before making major long-term commitments.

Unlike in the past, most new nuclear reactor and fuel cycle research is being done elsewhere (France, Japan, China, India, Russia, and South Korea)—a very different environment from that in which the U.S. led nuclear energy R&D. Large-scale cooperation has been historically difficult to achieve. However, research areas such as waste management science and technology serve the global interest and will in many cases be employed by national authorities. This may be a fruitful avenue for collaboration with less intellectual property complications than reactor technology development.

## CITATIONS AND NOTES

1. U.S. Department of Energy *Science Based Nuclear Energy Systems Enabled by Advanced Modeling and Simulation at the Extreme Scale*, E. Moniz and R. Rosner, Cochairs, Crystal City, Va., May 2009)
2. <http://www.er.doe.gov/ascr/ProgramDocuments/ProgDocs.html>
3. U.S. Department of Energy, *Nuclear Energy Research and Development Roadmap: Report to Congress* (April 2010)
4. Idaho National Laboratory, *Required Assets for a Nuclear Energy Applied R&D Program* (March 2009)
5. Safety regulations for nuclear power plants have been designed for LWRs. The regulations for LWR safety are not appropriate for other reactor technologies. The U.S. Nuclear Regulatory Commission is moving toward “technology-neutral” licensing where new technologies must meet the same safety goals but can use different approaches to meet those goals. However, cost and time to license any new technology is a major barrier to innovation and better systems—including nuclear systems with better safety, waste management, and nonproliferation characteristics. Federal funding in demonstration projects reduces the barriers for technologies with large social benefits but small economic ones to the companies commercializing such technologies.

# Chapter 3 Appendix — Uranium Resource Elasticity Model

Our conclusions on uranium costs versus cumulative production are based on a series of models where the results depend upon the input assumptions and the model. This appendix describes the mathematical models used in our analysis. The models can be used with different sets of assumptions.

## METHODOLOGY

The approach adopted involved development of a price elasticity of cumulative uranium consumption based on Deffeyes' model of reserves as a function of ore grade [1]. His work extended the log-normal model previously applied to individual mined deposits (e.g., by Krige for gold) [2] to the worldwide ensemble of deposits of uranium: See Figure A1. The region of interest in the figure is on the left-hand side, above about 100 ppm uranium, below which grade the energy expended to extract the uranium will approach a significant fraction of that recoverable by irradiation of fuel in LWRs. Numerical integration of his log-normal frequency distribution gives cumulative reserves as a function of ore grade in ppm. This result can then be manipulated to yield the sought-for elasticity. Numerical analysis validated the following semi-analytic approximation in the range of interest ( $10^2 - 10^4$  ppm).

$$s = \frac{\% \text{ increase in cumulative reserves}}{\% \text{ decrease in ore grade}} \quad [1]$$
$$\approx \frac{\sqrt{\pi}}{2\sigma^2} \left[ \ln x - \nu + \frac{\sigma}{\sqrt{2}} \right]$$

where

$x$  = ore grade, ppm U

$\nu$  = mean value of  $\ln x$ : (2.51)

$\sigma^2$  = variance of  $\ln x$ : (1.52)<sup>2</sup>

and note that  $\ln x = 2.303 \log x$ , since base 10 plotting is most common.



Figure 3A.2 shows the results. As can be seen, at about 1000 ppm, supply is predicted to **increase** about 2% for every 1% **decrease** in average grade mined. Note that  $s$  is positive (as opposed to conventional elasticity, which is its negative), and a linear function of  $\log x$ .

**Figure 3A.1 Deffeyes Log-Normal Frequency Model for Distribution of Uranium in the Earth. [1, 3]**

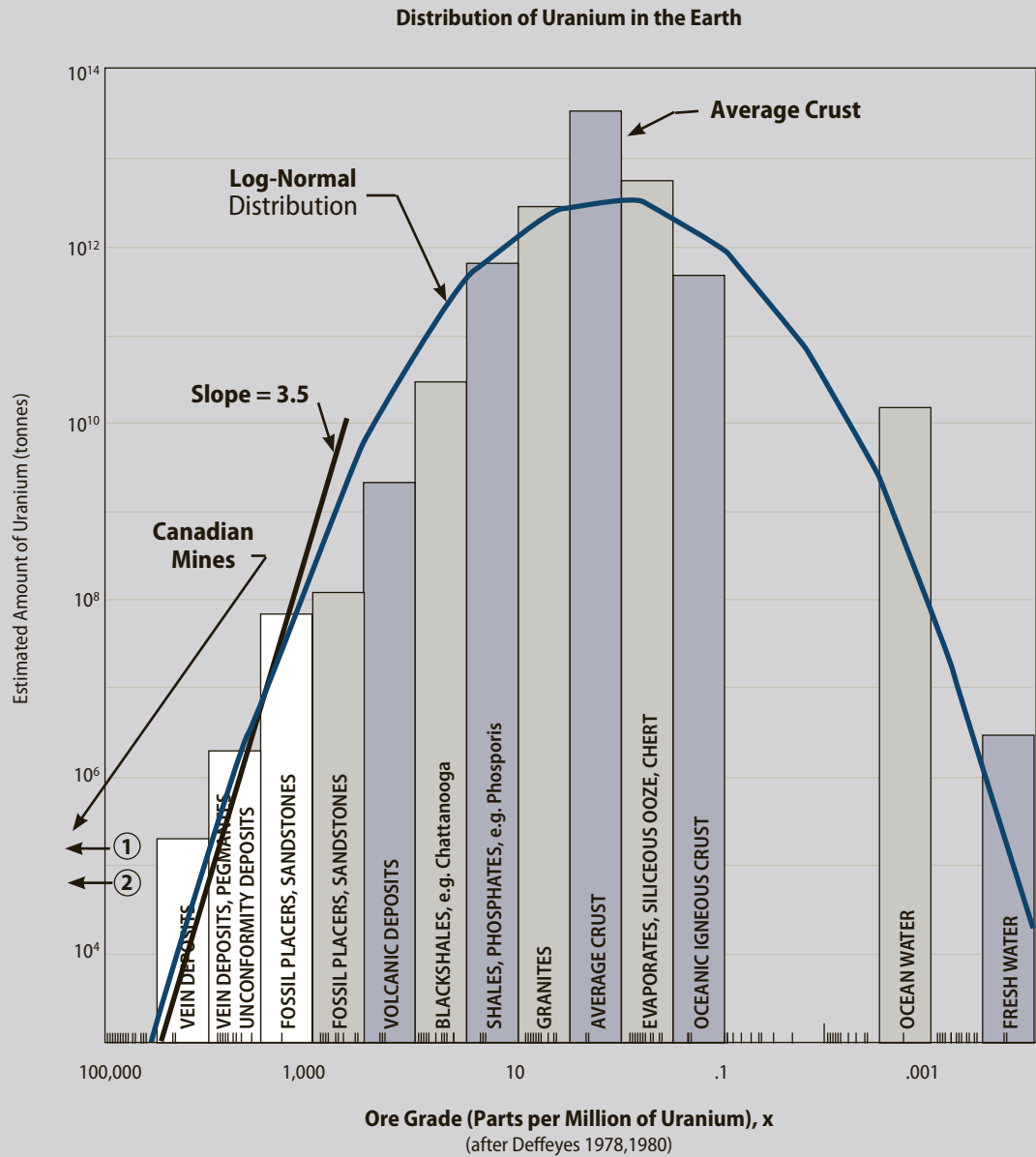

This result was then combined with the classical economy of scale and learning curve models of engineering economy (see Section 3B) to obtain a relation between cost  $C$ , \$/kgU and cumulative consumption of nuclear electricity (hence uranium)  $G$ , GWe-yr.

**Figure 3A.2 Elasticity of Uranium Resources with Respect to Ore Grade**

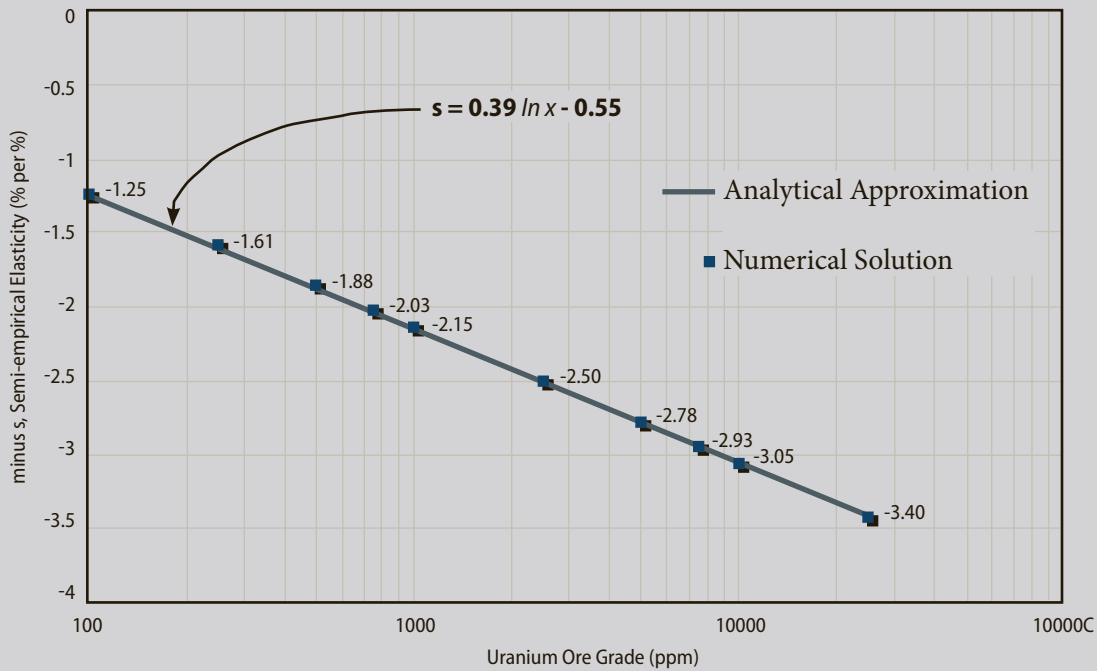

$$\left(\frac{C}{C_r}\right) = \left(\frac{G}{G_r}\right)^\theta \quad [2]$$

in which

$$\theta = \left(\frac{n}{s}\right) - \alpha$$

where

$n$  = economy of scale exponent (typically 0.7)

$\alpha$  = learning exponent:  $\ln(f/100) / \ln 2$

(hence 0.23 for  $f = 85\%$ )

In Eq. [2]  $C_r$  and  $G_r$  are reference (start of interval) values: for example, \$/kg  $U_{NAT}$  and cumulative gigawatt years of electric energy generation, respectively. Note that  $G$  can also be expressed as cumulative uranium consumption, since we assume a constant proportionality of 200 MT/GWe-yr at full power.

It should be evident that extrapolation into an ill-defined future is not properly a deterministic undertaking. Hence, following the lead in a similar effort in 1980 by Starr and Braun of EPRI, a probabilistic approach was adopted [4].

Figure A.3 plots Eq (2), where advantage has been taken of the fact that it is a straight line on log×log paper. Values of  $Cr = 100$  \$/kg and  $Gr = 10^4$  GWe-yr are assigned based on 2005 as the reference year. Trend lines for three values of  $\theta$  are shown, based on the probabilistic assessment described in Section 3.C. The plot is to be interpreted as the probability (e.g., 85%) that the cost (e.g., 200 \$/kg) will be less than the value on the trace plotted (in this example supporting  $\sim 10 \times 10^4$  GWe yr). Note that the 100% probability line (not shown) is given by  $\theta = 0.5$ , which matches the  $0.40 \leftrightarrow 0.52$  values in four of the (non-probabilistic) models surveyed by Schneider (5). Our value of 0.29 matches his “optimistic” value of 0.30.

Points are plotted on Figure 3A.3 corresponding to 2007 Red Book values for identified and identified-plus-undiscovered resources at under 130 \$/kg: 5.5 and 13.0 million metric tons. Also shown are cumulative consumption indicators for 100 years at one, five and ten times today’s rate. These benchmarks support the expectation that uranium production costs should be tolerable for the remainder of the 21<sup>st</sup> century — long enough to develop and smoothly transition to a more sustainable nuclear energy economy.

### Sample Applications

To employ this figure in scenario analysis one merely integrates under a postulated GWe vs time history (starting at 2005), divides by  $10^4$ , adds 1 (to include pre-2005 consumption), and reads off the projected cost of natural uranium in 2005 dollars as  $(C/Cr) \times 100$  \$/kg. Values for different values of  $\theta$  are readily plotted. In the following, the “conservative” 85<sup>th</sup> percentile value (i.e., median plus approximately-one sigma) of  $\theta = 0.29$  is used.

For example:

A scenario gives 50,000 GWe yr between 2005 and 2050, Hence  $(G/Gr) = 5 + 1 = 6$ . For  $\theta = 0.29$ , Figure 3A.3 gives  $(C/Cr) = 1.7$ , thus  $C = 170$  \$/kg in 2005 dollars as of 2050.

Scenarios are often based on simple exponential growth:

$$E(t) = Er e^{\gamma t}, \text{ Gwe}$$

Thus cumulative energy generation over a period of T years is:

$$\left(\frac{G}{Gr}\right) = 1 + \left(\frac{Er}{\gamma Gr}\right)[e^{\gamma T} - 1]$$

For example:

$$\begin{aligned} \text{Let } Er &= 400 \text{ GWe} \\ Gr &= 10^4 \text{ GWe yr} \\ \gamma &= 0.04 \text{ per yr} \\ T &= 80 \text{ years} \end{aligned}$$

Then

$$\left(\frac{G}{Gr}\right) = 24.5$$

**Figure 3A.3 Relative Uranium Cost vs. Normalized Cumulative Nuclear Energy Generation**

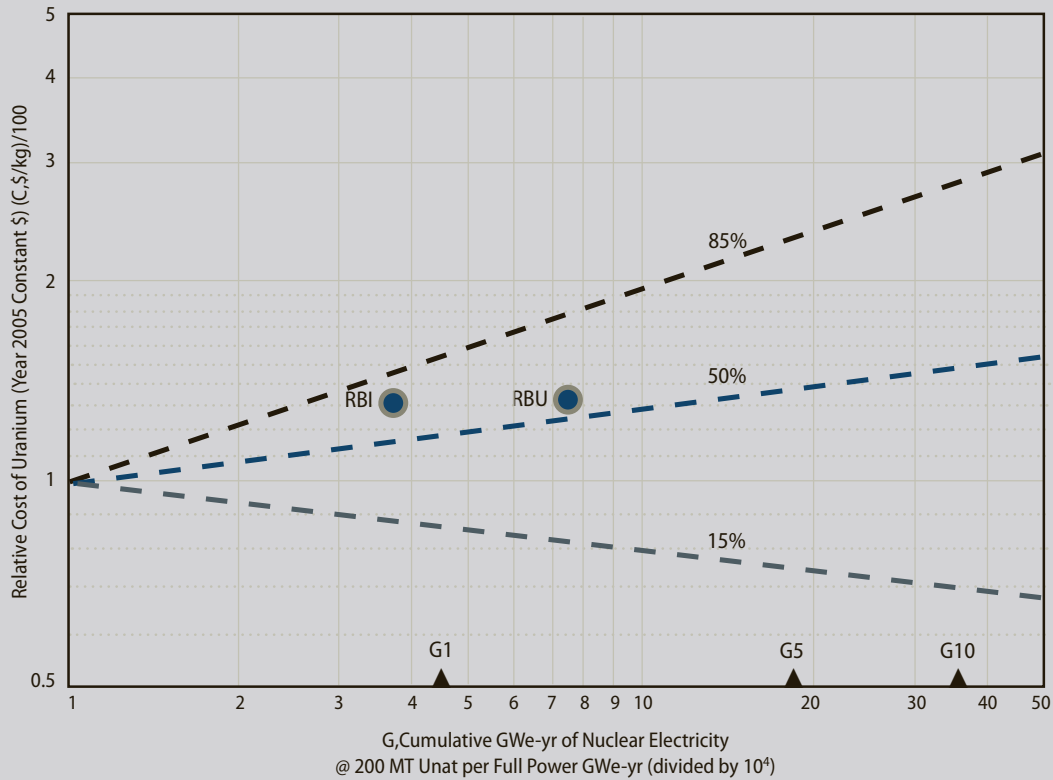

**Figure Key**

Lines Plot  $\left[ \frac{C, \$/\text{kgU}}{100} \right] = \left[ \frac{G, \text{GWe} - \text{yr}}{10^4} \right]^\theta$

- $\theta = -0.10$  for 15% CPDF Percentile, Optimistic Choice
- $\theta = 0.11$  for 50% CPDF Percentile, Median Case
- $\theta = 0.29$  for 85% CPDF Percentile, Conservative Choice

where G1 = 100 years at today's rate of uranium consumption and electric generation

G5 = 100 years at 5 × today's rate (equivalent to 2.7%/yr exponential growth)

G10 = 100 years at 10 × today's rate (equivalent to 3.6%/yr exponential growth)

also: RBI = 2007 Red Book, Identified, < 130 \$/kg

RBU = RBI + Undiscovered, < 130 \$/kg

BASE YEAR point @ [1,1] is 2005: 100 \$/kg & 10<sup>4</sup> GWe-yr

Again, assuming that  $\theta = 0.29$ , the plot gives  $C \cong 250$  \$/kg (vs. Eq. 2 @ 252.8), which would warrant serious consideration of timely development of alternatives to once-through LWRs. Again note that our estimates are in constant dollars: nominal dollars decades from now would be much higher.

By introducing the further approximation that the reference condition is just the integral of the exponential scenario from  $-\infty$  to 0, the following analytic relations can be derived (which obviates the need for the graphic method):

Cost at time T:

$$\frac{C(T)}{Cr} = e^{\theta\gamma T}$$

Average cost, 0 to T:

$$\frac{\bar{C}}{Cr} = \frac{e^{\theta\gamma T} - 1}{\theta\gamma T}$$

Thus for  $\theta = 0.29$ ,  $\gamma = 0.04/\text{yr}$ ,  $T = 80$  yrs as in our earlier example:

$$\frac{C(80)}{Cr} = 2.53; \quad \frac{\bar{C}}{Cr} = 1.65$$

$C(80)/Cr$  agrees within readable precision with the value given by the plot on Figure A.3.

## DERIVATION OF COST/CONSUMPTION RELATION

The approach applied in the present work was to combine models for the ore grade elasticity of cumulative resources (% change in cumulative natural uranium divided by % change in cutoff ore grade, ppm natural uranium), with economy of scale and learning curve correlations to find a relation between cost, \$/kg  $U_{\text{NAT}}$ , and cumulative resources  $\geq x$  ppm in grade, in metric tons of natural uranium. In turn, the required uranium can be expressed in terms of GWe-years of nuclear energy. The reader can then readily superimpose a demand growth scenario.

Assume scale effects apply to the mass of ore excavated and processed to obtain a kilogram of natural uranium. Then for an ore grade of  $x$  ppm, the unit cost is just:

$$\left(\frac{C}{Cr}\right) = \left(\frac{Xr}{X}\right)^n, \text{ $/kgU} \quad [3]$$

where  $n$  = scale exponent, typically  $\sim 0.7$  for many industrial chemical engineering processes and  $r$  refers to a reference case – e.g., the start of period.

The ore grade ratio can be related to cumulative resources through the ore grade elasticity of cumulative resources inferred from, in the present instance, a log-normal model based on Deffeyes' analysis. The model gives the slope (elasticity) as a function of the grade  $x$ ; using a representative average value over the range of interest:

$$\text{elasticity} = \frac{d \ln U}{d \ln X} = \varepsilon \quad [4]$$

$$\text{hence } \left( \frac{U}{U_r} \right) = \left( \frac{X}{X_r} \right)^\varepsilon = \left( \frac{X}{X_r} \right)^{-s}$$

where  $s$  is a positive quantity: the negative of the conventional elasticity.

In the above,  $U$  is the complementary cumulative distributive function, being the cumulative resource above the cutoff grade of  $X$  ppm (i.e., the integral from  $X$  to  $\infty$ ), as opposed to the conventional cumulative function (the integral from 0 to  $X$ ). Thus the slope,  $d \ln U / d \ln X$ , is negative: the resource **decreases** as  $X$  is increased. If conventional elasticity,  $\varepsilon$ , is defined as % **increase** in  $U$  per % **increase** in  $X$ , then the elasticity,  $s$ , of interest here is % increase in  $U$  per % **decrease** in  $X$ , hence  $s = -\varepsilon$ . Confusion can be avoided by recognizing that  $s$  is always a positive quantity. Thus the negative  $\varepsilon$  values plotted in Figure A.2 are taken as positive  $s$  values in our analyses.

Equations [3] and [4] combine to give:

$$\left( \frac{C}{C_r} \right) = \left( \frac{U}{U_r} \right)^{\frac{n}{s}} \quad [5]$$

This expression allows for cost scaling due only to unit operation size. However, it is well known that added savings accrue due to learning during long-term operation. For minerals, progressive learning also improves the technology used in prospecting for, delineating, and assaying promising deposits.

For learning effects we assume a learning unit of  $M$  metric tons of product ( $U_{\text{NAT}}$ , not its host ore) in which case the number of units processed is just  $N = U/M$ , where  $U$  is cumulative natural uranium production. Thus, since  $Nr = Ur/M$ , one simply has for the ratio with/without learning:

$$\left( \frac{C}{C_r} \right) = \left( \frac{U}{U_r} \right)^{-\alpha} \quad [6]$$

where

$$\alpha = - \left[ \frac{\ln(f/100)}{\ln 2} \right]$$

in which  $f$ , the progress rate is typically about 85%, hence  $\alpha = 0.23$

Therefore multiplication of Eq. [5] by the with/without correction factor gives the composite expression:

$$\left( \frac{C}{C_r} \right) = \left( \frac{U}{U_r} \right)^\theta \quad [7]$$

where

$$i = \left( \frac{n}{s} \right) - \alpha$$

which has the virtue of reducing to correct limits

(e.g., as  $n \rightarrow 0$ , or  $s \rightarrow \infty$ , or  $\alpha \rightarrow 0$ ).

Thus for  $n = 0.7$ ,  $s = 2$ ,  $\alpha = 0.23$ , one has  $i = 0.12$ .

Note that Eq. [7] suggests employing a log-log plot, such that the relation appears as a straight line.

One further modification is useful. Assume that LWR reactors require a fixed amount of natural uranium per GWe-year of electrical energy generated (e.g. 200 MT  $U_{\text{NAT}}$ /full power GWe-yr). Then

$$\left(\frac{C}{Cr}\right) = \left(\frac{G}{Gr}\right)^\theta \quad [8]$$

This normalized form is employed in the presentation of our results.

The relations can also be manipulated to give cost as a function of ore grade:

$$\left(\frac{C}{Cr}\right) = \left(\frac{Xr}{X}\right)^{\bar{s}\theta} \quad [9]$$

where  $\bar{s}$  is an average value over the range of  $x$  values considered. For example, let  $\bar{s} \sim 2.25$  (roughly appropriate for  $x = 2000$  ppm in Figure A.2; and take  $\theta = 0.11$  (our 50% percentile value in Figure A.3). Then cost is inversely proportional to  $x^{0.25}$ , such that a factor of ten decrease in grade would increase cost per kilogram by approximately 1.78 times. This may seem optimistic, but one should keep in mind that it is a forward looking projection after economy of scale and learning effects have had the opportunity to come into play.

It is interesting to note that a fit to cost vs crustal abundance data for different metals plotted in Ref (6) gives an inverse proportionality of  $x^{0.39}$ . The exponent is what our model would predict for  $\theta = 0.17$ , the 65% value.

### PROBABILISTIC ESTIMATION OF THE COST CORRELATION PARAMETER, $\theta$

To implement the simple cost versus cumulative consumption model devised in this chapter, characterization of three coefficients is required:

- $n$ , the economy of scale exponent
- $s$ , the negative of the resource vs. ore grade elasticity
- $f$ , the percent learning (hence  $\alpha$ )

These combine to yield  $\theta$ :

$$\theta = \frac{n}{s} - \alpha \equiv \frac{n}{s} + \frac{\ln(f/100)}{\ln 2} \quad [10]$$

All of these parameters can vary over a wide range, which introduces an unavoidable degree of uncertainty in  $\theta$ . Accordingly, a Monte Carlo based approach is adopted to repetitively randomly sample all three from probability distributions so as to develop a frequency distribution for  $\theta$  using Eq. (A10).

## Probabilistic Approach

Given the present state of knowledge, the parameters  $n$ ,  $s$ , and  $f$  were each assumed uniformly distributed over a range suggested by a review of the applicable literature:

$$\begin{aligned}0.5 &\leq n \leq 1.0 \\1.5 &\leq s \leq 3 \\70\% &\leq f \leq 100\%\end{aligned}$$

The ranges were selected as follows:

### (a) Economy of scale exponent, $n$

Reference (7) reports  $n$  values for a total of 28 plants and processes. The mean is 0.63 and the range 0.40 to 0.83.

Simon suggests a data-based exponent of 0.5 based on the scale of an industry as opposed to that of an individual production unit (8).

Finally, several of the cruder models for uranium costs surveyed by Schneider (9) take no credit for scale economies, hence, in effect,  $n = 1.0$ .

To encompass this information a uniform range between 0.5 and 1.0 was assumed.

### (b) Resource vs. grade elasticity, $s$

Determination of this parameter based on Deffeyes' model has been described in the main text of this chapter. The results were plotted in Figure A.2.

The range selected spans ore grades between 200 and 10,000 ppm. This allows for not only evolution over time, but for the fact that grade varies within a given mine and between different mines, and exploitation is not necessarily in descending rank order of grade.

### (c) Learning, $f$

Reference (10) reviews learning curve studies, and reports a range consistent with other findings of approximately 70 to 100%. The upper limit also accommodates most earlier uranium production cost studies, which apparently take no credit for learning.

## Results of Analysis

Figure 3A.4 plots the results generated by  $10^4$  trials, sorted into  $\Delta\theta$  bins, together with a smoothed polynomial curve fit.

The results were used to identify  $\theta$  values corresponding to  $\leq 15\%$ ,  $\leq 50\%$ ,  $\leq 85\%$ , namely  $\theta = -0.10, 0.11, 0.29$ . These are the values used in Figure A.3 to provide "optimistic," "median case," and "conservative" cost lines. Note in Figure A4 that some values of  $\theta$  are negative, which shows that the approach could accommodate the historical records of falling metal costs over the course of the 20<sup>th</sup> century if appropriate values of  $n$ ,  $s$ , and  $f$  were specified.



**Figure 3B.1 Cumulative Probability Distribution Function for  $\theta$**

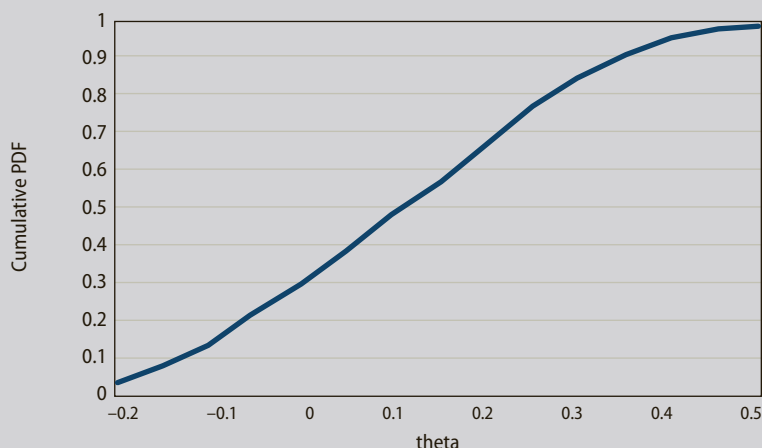

### Discussion

The overall model in its present form is admittedly crude. However, it provides a framework for incorporation of future improvements. In particular, better (than uniform) frequency distribution functions for  $n$ ,  $s$ , and  $f$  could be specified, given greater insight into uranium geochemistry and mining experience. Allowing  $n = 1$  and  $f = 100\%$  merely to accommodate past oversimplification is open to question. Following the practice adopted in the recent AFCI review (3), a triangular PDF, zero at the low and high values of the range, and peaked at the nominal value, may be warranted.

### SEPARATIVE WORK (SWU) REQUIREMENTS

This subject is of interest because SWU can be traded off for natural uranium feed requirements, by reducing the enrichment facility tails composition. Per kg of product,  $P$ , at enrichment  $X_p$ , given in weight percent (w/o),  $F$ , the  $U_{NAT}$  feed required is:

$$\frac{F}{P} = \frac{X_p - X_w}{X_N - X_w}$$

where  $X_N = 0.711$  w/o, natural uranium enrichment  
 $X_w =$  specified tails enrichment

Curve fits to data from the exact expression for kg of SWU per kg of product (S/P) in the range of interest ( $2.5 < X_p < 7$  w/o) give the following linear approximations:

$X_w$ W/O	S/P ~
0.10	$3.00 X_p - 3.03$
0.15	$2.57 X_p - 2.72$
0.20	$2.27 X_p - 2.51$
0.25	$2.06 X_p - 2.36$
0.30	$1.89 X_p - 2.24$
0.35	$1.75 X_p - 2.14$

Other values can be determined by interpolation.

Fuel cost is minimized at a tails composition given to a good approximation by:

$$X_{w,OPT} = \left[ \frac{1}{2.425 + 1.925 \left( \frac{C_F}{C_S} \right)} \right], \text{ w/o}$$

where  $C_F$  = cost of natural uranium (plus conversion to  $UF_6$ ), \$/kg  
 $C_S$  = cost of SWU, \$/kg

Thus for  $C_F/C_S = 2.2$ ,  $X_{w,OPT} = 0.15\%$ .

Comparing  $X_w = 0.3$  w/o and  $X_w = 0.15$  w/o for  $X_p = 5$  w/o gives  $F/P = 11.44$  and  $8.65$ , respectively. Hence in this case reducing tails to their optimum value decreases  $U_{NAT}$  consumption by 24%. Or, for example, moving from 0.25 w/o to 0.10 w/o tails increases SWU, hence separation costs, by 50%, and reduces ore requirements by 22%.

## CITATIONS AND NOTES

1. K. Deffeyes, I. MacGregor, 1978, 1980, "Uranium Distribution in Mined Deposits and in the Earth's Crust," Final Report to US DOE, Grand Junction Office, August 1978; also *Scientific American*, Vol. 242 (1980)
2. G. S. Koch Jr., R. F. Link, "Statistical Analysis of Geological Data," Wiley, 1970
3. D. E. Shropshire et al., 2008, "Advanced Fuel Cycle Cost Basis," INL/EXT-07-12107, Rev. 1, March 2008.
4. C. Starr and C. Braun, "Supply of Uranium and Enrichment Services," *Trans. Am. Nucl. Soc.* Vol. 37, Nov. 1980
5. E. Schneider, W. Sailor, 2008, "Long-Term Uranium Supply Estimates," *Nuclear Technology*, Vol. 162, June 2008
6. M. Taube, "Evolution of Matter and Energy on a Cosmic and Planetary Scale," Springer-Verlag, 1985
7. M. S. Peters, K. D. Timmerhaus (1980), "Plant Design and Economics for Chemical Engineers," 3<sup>rd</sup> Edition, McGraw-Hill
8. J. L. Simon, "The Ultimate Resource," Princeton University Press, 1981
9. E. Schneider, W. Sailor, "Long-Term Uranium Supply Estimates," *Nuclear Technology*, Vol. 162, June 2008. Also "The Uranium Resource: A Comparative Analysis," *Global 2007*, Sept. 2007
10. R. Duffey (2003), "Innovation in Nuclear Technology for the Least Product Price and Cost," *Nuclear Plant Journal*, Sept. – Oct. 2003



# Chapter 5 Appendix — Waste Management

## PRINCIPLES OF WASTE MANAGEMENT

Radioactive waste, like any other forms of waste, is the residual product from the operation of a facility. Its potential impact on the public and the environment depends on its physical, chemical and radionuclide characteristics. These characteristics determine risk and establish a recommended disposition path for the material.

For any hazardous waste, there are only three waste management options: destruction (transformation to a less hazardous substance), dilution to acceptably low concentrations in the environment, or isolation from mankind and the biosphere for a period commensurate with the longevity of the hazard. The primary method for management of radioactive wastes is isolation. The isolation should be long enough such that if and when the radioactive residues eventually re-appear in the biosphere, they will be present at concentrations low enough to satisfy some health-based dose acceptance criteria.

This waste management strategy is a consequence of the defining characteristic of radioactive materials—they decay to non-radioactive elements over time. For example, radioactive cobalt-60 has a half-life of ~5 years. With a half-life of 5 years, half the cobalt-60 decays away to stable nickel-60 in 5 years. In another 5 years, half of the remaining cobalt-60 decays away. The process continues until all the cobalt-60 is gone. Most radioactive wastes contain mixtures of different radioactive isotopes where the characteristics of the longer-lived radionuclides usually determine the preferred disposal option. Figure 5A.1 shows the SNF radioactivity versus time after discharge from the reactor.

For any radioactive waste, the waste isolation technology chosen depends upon the half-life of the radionuclide, geochemical mobility, and radiotoxicity. For radionuclides with half-lives of a few days or less, such as some medical wastes, the waste may be stored in a cabinet or closet at the facility until the radionuclides have decayed to very low concentrations. For longer-lived wastes, the disposal (storage) facility must isolate the waste for longer periods of time.

## WASTE GENERATION

Different fuel cycles generate different waste streams. Table 5A.1 lists wastes from the open and closed fuel cycles. The United States has an open fuel cycle. Several countries (France, Japan, etc.) recycle fissile materials back to reactors.

**Figure 5A.1 Decay of Radioactivity in Spent Nuclear Fuel with Time**

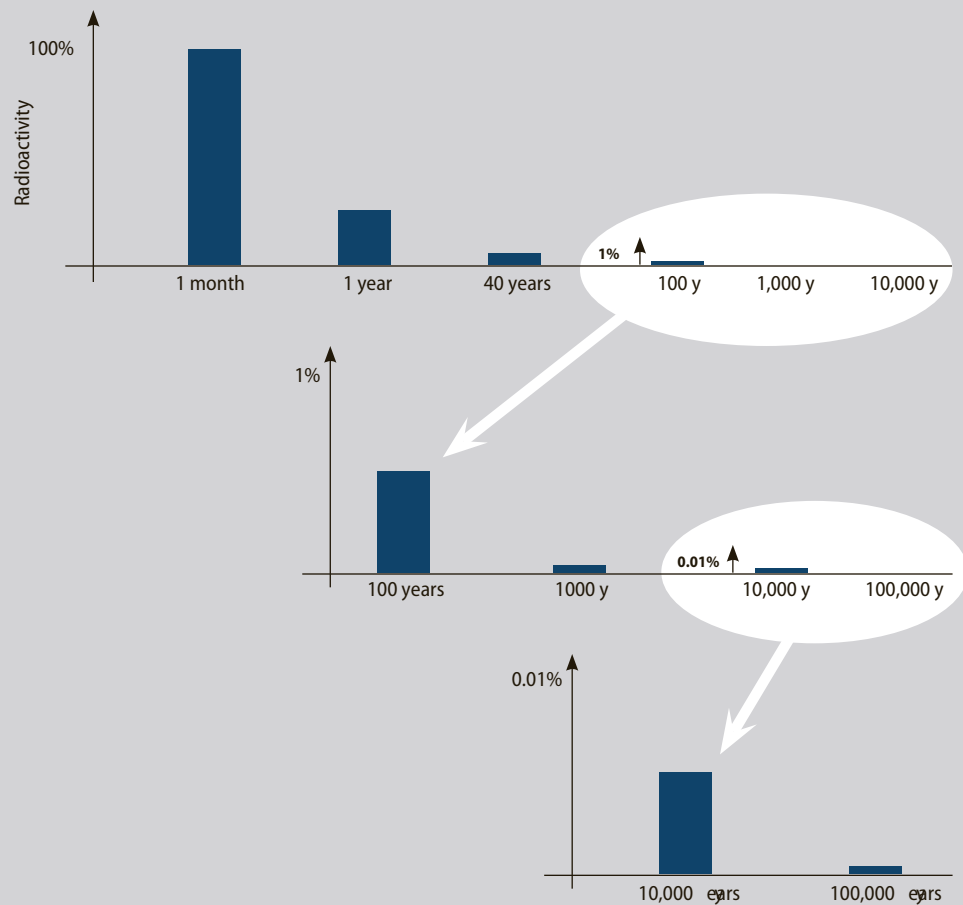

Source: A. Hedin, Spent Nuclear Fuel—How Dangerous Is It?, Svensk Kambranslehantering AB, TR-97-13, March 1997.

The primary waste from today's once through fuel cycle is LWR SNF. The composition of a typical spent LWR assembly<sup>1</sup> is shown in Figure 5A.2. Other types of fuel assemblies will have different characteristics; however, in general the actinides and fission products are generally a small fraction of the total fuel assembly.

The fuel cycle incentives for recycle of SNF are discussed elsewhere. If SNF is recycled, there are three potential waste management benefits.

- *Reduced uranium mining.* Significant wastes are generated in uranium mining and assessments<sup>2</sup> show that the largest fuel cycle impacts are from uranium mining—not the repository. Recycle reduces the impacts from these operations by reducing uranium mining operations.
- *Option for superior storage and or disposal forms relative to SNF.* If SNF is recycled, the waste form chemistry can be selected to maximize repository performance.
- *Reduction of fissile materials from waste streams.* This has three potential benefits.
  - Reduced heat generation in the wastes that can reduce repository size. Actinides are responsible for the longer term heat generation in the repository—particularly <sup>241</sup>Pu

**Table 5A.1 Primary Waste Resulting from Once-Through Operation\* and Closed Fuel Cycles From a 1-GW(e) Power Plant**

OPERATION	TYPE OF WASTE	
	OPEN FUEL CYCLE	CLOSED FUEL CYCLE
Uranium mining and Milling	Sandy Tailings – same composition as uranium ore and not classified as radioactive waste	Lesser quantity
Conversion and Enrichment	Depleted Uranium (~175 tons) stored either as $UF_6$ or $U_3O_8$ . May be waste or useful product for making recycle fuel or further recovery of $^{235}U$ .	Lesser in quantity. Requires dedicated lines for conversion and enrichment of reprocessed uranium. New types of depleted uranium tails containing U-232
Fuel Fabrication	Very small quantities of LLW	Contains long-lived isotopes and requires geological disposal
Electricity Generation (LWR cooling pools, Interim storage and Geological disposal)	<ul style="list-style-type: none"> <li>• 200-350 m<sup>3</sup> LLW and ILW (small quantities ILW primarily during decommissioning)</li> <li>• 20 m<sup>3</sup> (27 tonnes) of SNF equivalent to about 75m<sup>3</sup> disposal volume</li> </ul>	Spent Recycled Fuel whose composition differs from $UO_x$ derived SNF. If full recycle all types of spent fuel are recycled.
Reprocessing Facility	None	<ul style="list-style-type: none"> <li>• High level wastes (glass) containing fission products and some actinides</li> <li>• Recycle of plutonium</li> <li>• Partial or full recycle of other actinides depending upon goals</li> <li>• Activated cladding and hardware and entrained solids</li> <li>• Off-gas (<math>H_2</math>, <math>I_2</math>, C, Kr and Xe)</li> <li>• Secondary wastes (IX resins, zeolites, organic solvents, etc.) depending upon the choice of technology</li> </ul>

\* World Nuclear Association, *Radioactive Waste Management*, June 2009, <http://www.world-nuclear.org/info/inf04.html>

**Figure 5A.2 Composition of a Typical Spent LWR Assembly**

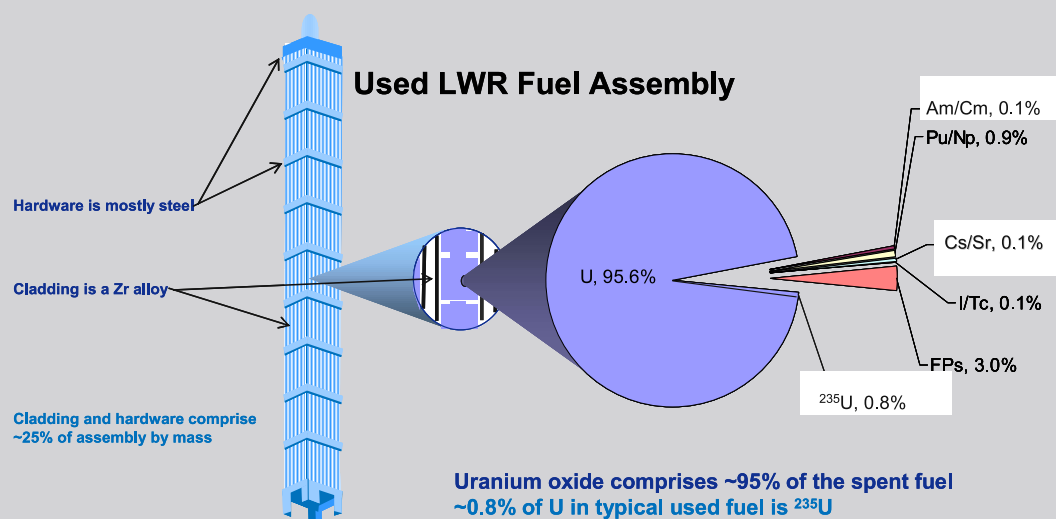

and  $^{241}\text{Am}$ . For the short term, heat is dominated by fission products and this is unchanged by recycling.

- Safeguards. Removal or reduction of fissile materials reduces the complications from safeguards in waste facilities.
- Hazard reduction. Reducing the toxicity of the waste reduces risks from disruptive events (volcano, human intrusion) to the repository.

The waste management disincentive for SNF recycle is that recycling creates many additional waste streams compared to a once-through fuel cycle resulting in a more complex waste management system.

## GEOLOGICAL REPOSITORY DESIGN AND CHARACTERISTICS

Geological disposal is the preferred option for isolation of long-lived radioactive and chemical wastes from the biosphere and man. This appendix provides a brief description of the science, engineering, and regulation of geological waste isolation systems.

### Repository Science

Geological isolation is based on the observation that materials deep underground in many locations have remained unchanged for millions to hundreds of millions of years. The lifetimes of radioactive wastes are short relative to these timeframes.

Geologic repositories are located several hundred meters underground to protect the disposal site from natural events (land erosion, glaciation, etc.) and man-made events (surface disturbances, war<sup>3</sup>, etc). All existing and planned repositories use traditional mining technology for repository construction. This allows close inspection of the rock at the disposal horizon while not disturbing the rock above the disposal horizon.

The primary transport mechanisms for radionuclides from the repository to the biosphere and man are dissolution of radionuclides into groundwater or formation of stable colloids (small particles) in groundwater, movement of that groundwater to the biosphere, and use of that groundwater for drinking or the growing of food. There are several mechanisms to slow radionuclide transport via groundwater to the open environment to provide time for radioactive decay.

- ▣ *Groundwater flow.* Water flow through the site is minimized by choosing sites with low water flow. Engineered barriers such as waste packages and backfill slow groundwater contact with the waste. Radionuclides that reach groundwater are diluted by the groundwater flow.
- ▣ *Insoluble waste form.* For radionuclides to move in groundwater, they must be soluble or form colloids in groundwater. The geology and engineering barriers (waste form, waste package, and backfill) can be chosen so most radionuclides are insoluble in groundwater. Within a waste form, the insoluble components slow the release of soluble components by matrix diffusion.

▣ *Radionuclide absorption.* As groundwater with radionuclides flows through engineered barriers and rock, many radionuclides are absorbed on rock surfaces slowing their transport to the biosphere and providing time for radioactive decay.

Different repositories located in different geologies have different geochemical conditions and different types of groundwater. Consequently, the radionuclides that may escape from a repository over time are different for different repositories. Table 5A.2 lists the nuclides that are thought to determine the performance in several proposed repositories—the radionuclides most likely to escape from a repository via groundwater and result in a radiation dose to humans.

The primary failure modes for repositories are mechanisms such as slow corrosion of waste packages and dissolution of radionuclides into groundwater—mechanisms that require thousands to hundreds of thousands of years. In most repository environments, actinides (plutonium, etc.) are not expected to escape from the repository because of their low solubility in groundwater and sorption on rock.

A repository is a local zone containing highly hazardous materials. Natural or manmade intrusion (such as well drilling) can release other radionuclides<sup>4</sup> and short circuit the geological barriers to waste isolation. In these failure scenarios, waste toxicity can become a relevant measure of risk. While actions such as drilling a well within the repository boundary can have serious impacts for individuals, in most intrusion scenarios the impacts are local and limited because relatively small quantities of wastes are physically brought to the surface.

Since the 1970s radiotoxicity has been sometimes used as an indicator<sup>5,6,7</sup> of the intrinsic hazard of wastes. The waste in a repository is compared to the toxicity of uranium or other natural ore bodies. There are many measures of toxicity depending upon whether a specific radionuclide is dissolved in drinking water, inhaled as a particle, is a one-time dose to a human, or cumulative accumulation in the human body. The relative toxicity of the repository<sup>8,9,10</sup> becomes less than that of a uranium ore body somewhere between a thousand and five million years, depending upon toxicity conversion factors. However, such comparisons have limited validity. There is the question of whether a uranium ore body is the appropriate basis of comparison. Uranium, like lead, arsenic, and cadmium, is a heavy metal and its chemical toxicity exceeds its radiotoxicity. Large heavy-metal ore bodies have similar toxicities to uranium ore bodies and thus repositories after some period of time. There is also the fundamental difficulty that toxicity does not measure risk. There is enough lead in car batteries to chemically kill everyone in the U.S. many times over—yet the risk from chemical poisoning from car batteries is low. That is because the risk from any toxic material is determined by its chemical behavior that determines if it can migrate via groundwater or other routes from disposal sites to man.

**Table 5A.2 Radionuclides Controlling Repository Performance in Different Geologies**

REPOSITORY	LIMITING RADIONUCLIDE
United States (Tuff)	<sup>99</sup> Tc (half-life: 2. x 10 <sup>5</sup> y) for times 0-20,000 years <sup>239</sup> Pu (half-life: 2. x 10 <sup>4</sup> y) for times 20,000 to 200,000 years <sup>242</sup> Pu (half-life: 4. x 10 <sup>5</sup> y) for beyond 200,000 years
Sweden (Granite) <sup>1</sup>	<sup>226</sup> Ra (half-life: 1600 y) from uranium and other actinide decay chains
France (Clay) <sup>2</sup>	<sup>129</sup> I and <sup>36</sup> Cl (Normal evolution scenario)
Belgium (Clay) <sup>3</sup>	<sup>79</sup> Se (half-life: 1.1. x 10 <sup>6</sup> y (then <sup>129</sup> I, <sup>99</sup> Tc)

Notes

- 1.Svensk Karnbranslehantering AB (Swedish Nuclear Fuel and Waste Management Company), *Long-Term Safety for KBS-3 Repositories at Forsmark and Laxemar-A First Evaluation*, TR-06-09 (October 2008).
- 2.ANDR A Dossier 2005 Clay: *Assessment of Geological Repository Safety*
- 3.D. Mallants, J. Marivoet, and X. Sillen, "Performance Assessment of the Disposal of Vitrified High-Level Waste in a Clay Layer", *J. Nuclear Materials*, **298**, 125-135 (2001)



## Repository Engineering

All repositories for SNF disposal plan to use long-lived waste package designed to last thousands to hundreds of thousands of years. Because radioactivity decays with time (Figure 5A.1) the waste package can provide a significant barrier to radionuclide release when the hazard is the greatest and enable the wastes to be retrieved if a problem is found in the performance of the repository.

SNF and HLW generate significant decay heat that could raise repository temperatures sufficiently to accelerate degradation of the waste, waste package and geology with degradation of repository performance. This has several implications.

- ❑ Repository temperatures are controlled by limiting the decay heat per waste package (that is, the quantity of SNF and HLW in each package) and spreading out the waste packages over a large underground area. Decay heat is conducted from the waste through the waste package and the rock ultimately to the earth's surface.
- ❑ Repository cost and size is partly dependent upon total SNF and HLW decay heat. The greater the total heat load, the larger the number of waste packages and the more tunnels that must be constructed to spread the SNF and HLW over a large area. For the proposed YM repository, about 40 tons of SNF can be emplaced per acre of repository space. This implies about 50 acres of repository are needed to dispose of a year's production of SNF in the U.S (~2000 tons).
- ❑ Repository programs have adopted a policy of storing SNF and HLW for 40 to 60 years before disposal to reduce decay heat and thus reduce repository costs and performance uncertainties. Engineering tradeoffs determine storage times. After the first decade, the fission products strontium-90 ( $^{90}\text{Sr}$ ) and cesium-137 ( $^{137}\text{Cs}$ ) produce most of the decay heat. These radionuclides have 30-year half-lives and thus the radioactivity and decay heat drops in half every 30 years. After ~50 years, the transuranic isotope  $^{241}\text{Am}$  becomes the dominant source of decay heat in SNF with a half life of 470 years before decaying to Neptunium-237 ( $^{237}\text{Np}$ ). The decay heat per fuel assembly initially decreases at a rapid rate and then slows down when the decay heat is controlled by  $^{241}\text{Am}$ . This occurs 40 to 60 years after SNF discharge—the technical basis for the storage time.

Repository capacities are not limited by waste volume or mass. For some wastes there are incentives to increase waste volumes to improve repository performance. For example, liquid HLW is converted into HLW glass for disposal.<sup>11</sup> This increases waste volumes by a factor of three to four compared to calcining the waste; but, glass is a superior waste form with lower handling risks and is less soluble in water—resulting in better repository performance.

Economics is not a major repository engineering constraint. The cost of geological disposal of HLW and SNF is a small fraction of the cost of nuclear electricity—typically a few percent of the cost of electricity.

## Repository Regulation and Performance Assessments

In the United States, the Environmental Protection Agency (EPA) defines the safety standard that the repository must meet<sup>12</sup>. For the proposed YM repository, the EPA maximum allowable radiation dose at the boundary of the repository for the most exposed person<sup>13</sup> must not exceed 15 mrem/year anytime during the first 10,000 years or 100 mrem from 10,000 to one million years. As a basis of comparison, the total average annual radiation dose to an American is estimated to be 360 mrem/year. While the regulatory standards vary from country to country, the allowable releases in other countries is some fraction of the natural background radiation levels.

It is difficult to predict what will happen far into the future. This has led to examination of different types of safety indicators<sup>14</sup> to obtain some perspective of future risks independent of any specific site or facility. These indicators are generally based on observations of the performance of natural analogues including uranium ore deposits, other metal ore deposits, and the evolution of natural nuclear reactors over time.<sup>15</sup> For example, the U.S. Nuclear Regulatory Commission<sup>16</sup> has also compared the relative toxicity of a radioactive waste repository to a uranium ore body to help establish a reasonable time frame of concern when evaluating a repository. Their analysis indicates that within about 10,000 years the repository toxicity is within a factor of ten of the ore body.

The results of many different types of assessments have created the broad consensus within the geological and scientific community that a properly sited and designed repository presents very low risks to the public.

There are proposals to burn radionuclides in wastes in nuclear reactors to improve repository performance by destroying (1) the more toxic long-lived radionuclides in waste or (2) the major heat-generating radionuclides. Our analysis and analysis by others<sup>17</sup> have found only limited benefits in the context of waste management.

- ❑ Chemical behavior, physical form, and half-life determine the potential for release of a radionuclide from a repository—not toxicity. Destroying the most toxic radionuclides may or may not improve repository performance.
- ❑ The radionuclides that limit repository performance are different for different geologies. If the goal is to destroy the radionuclides that limit repository behavior, the repository site must be known before undertaking a program to burn specific actinides.
- ❑ There are risks associated with actinide burning. Our analysis (Chapter 6) shows that it would take a century or longer to destroy a significant fraction of the long-lived radionuclides. The risks of processing and handling such wastes appear significantly greater than the risks of disposal.

Some closed fuel cycles destroy selected long-lived radionuclides as a byproduct of fissile fuel cycle. It is a benefit that should be considered when considering alternative fuel cycles.

## REPRESENTATIVE REPOSITORY DESIGNS: UNITED STATES, SWEDEN, AND FRANCE

Four repository designs are briefly described herein and show that there are many different ways to design a geological repository.

The Waste Isolation Pilot Plant,<sup>18,19,20</sup> the operating repository in the U.S for defense transuranic waste, is in a massive bedded Permian salt deposit 658-meters underground. Salt has two characteristics: it is plastic so openings close over a period of decades and its existence indicates no flowing groundwater. If there was flowing groundwater, the salt would have been dissolved. The hydraulic conductivity of the formation is less than  $10^{-14}$  m/s and the diffusion coefficient is less than  $10^{-15}$  m<sup>2</sup>/s, thus the presence of trapped 230 million-year-old sea water throughout the formation. The primary safety case is that salt beds are massive structures over tens or hundreds of miles. The physical size implies hundreds of thousands to millions of years to dissolve sufficient salt to threaten such a repository. The EPA requires at least one engineered barrier at any geological disposal site. The engineered barrier is magnesium oxide that is embedded with the transuranic wastes to buffer the pH of any liquid in the salt to 8.5 to 9—conditions under which plutonium is relatively insoluble and colloids do not form. It is a chemical barrier to the movement of radionuclides in this system.

The proposed U.S. repository at Yucca Mountain for SNF and HLW is in tuff—consolidated volcanic ash. The repository is above the water table in an oxidizing environment—the only proposed repository in such an environment and thus a design significantly different than other proposed repositories. SNF is to be placed into steel containers typically containing 21 fuel assemblies. The steel containers have a thick external layer of a highly-corrosion resistant nickel alloy. The waste packages are to be placed in tunnels that will remain open after repository closure. Above the waste packages is a titanium drip shield (semicircular structure) to divert water as it flows from the surface through the tuff to the groundwater below the repository horizon. The engineering barriers are designed to delay contact of the wastes with water.

The proposed Swedish repository is in granite—a solid rock with a chemically reducing environment. The waste package is a steel container with a thick external layer of copper. Copper was chosen for the waste package because metallic copper has existed unchanged for hundreds of millions of years in Swedish granite—a basis to expect long-term integrity of the waste package. The copper waste package is placed at repository depth and surrounded by a compacted bentonite-sand mixture between the waste package and granite. This material has low permeability to water flow and absorbs many radionuclides. Bentonite is typically used in earth dam construction to minimize water flow. All repository tunnels are to be filled with a similar mixture to minimize groundwater flow in the repository. The planned repository in Finland has a similar design.

The proposed repositories in France and Belgium are located in clay that has a very low permeability to groundwater flow, has highly reducing chemical conditions that minimize the solubility of most radionuclides in groundwater, and high absorption of radionuclides. Most radionuclides (and all actinides) are highly insoluble in such environments. However, clay has a very low thermal conductivity; thus, the waste loading per acre will be lower than in other repositories to avoid excessive temperatures in the repository. The wastes will be in steel waste packages. All access tunnels will be filled with low-permeability backfill to minimize groundwater movement.

## U.S. REPOSITORY HISTORY

The United States initiated its repository program in the mid 1950s for the disposal of defense wastes. After a series of failed attempts,<sup>21, 22</sup> the Congress passed the Nuclear Waste Policy Act (NWPA) in 1982 that included a long-term plan to site, build and operate a repository for SNF and HLW.

The Act defined the transfer of liability for HLW and SNF from utilities to the government, allowed the option to create a separate agency for managing the repository program, created a levy on nuclear-generated electricity to pay for disposal with the program having direct access to the fund, a plan to build one repository in the east and a second repository in the west based on considerations of equity, and authorization for the program to negotiate with states and local governments to provide long-term compensation. In the years following the NWPA, there were major changes in the program.

- ▣ The decision was made to manage the program within the Department of Energy in a dedicated organization rather than create an independent agency.
- ▣ A series of laws<sup>23</sup> to balance the federal budget changed the financing. Originally, the repository program was to have full access to the trust fund. The changes in federal law resulted in program funding determined by annual Congressional appropriations.
  - Congress under-funded the program.
  - Congress set yearly repository priorities, determining the program scope.
  - Compensation to states and local communities for a proposed repository depended upon annual appropriations
  - The NWPA was amended in 1987<sup>24</sup> with a decision that only one site would be considered for a repository and that site would be the Yucca Mountain site in Nevada. This broke the previous agreements on the repository siting process.<sup>25</sup> It resulted in increased opposition to the proposed Yucca Mountain repository in Nevada and a series of events that led to the recent Administration decision to terminate that project.

Many of these difficulties were foreseen. The NWPA required a report on alternative means of financing and management (AMFM). An advisory panel, established in 1984, prepared a report<sup>26</sup> that recommended the establishment of a FEDCORP, a federally chartered, government-owned corporation, to be responsible for all operations prior to closure of the repository based on the previous decades of repository program history. In many cases key decisions associated with earlier repository program failures were driven by other agency priorities that were considered more important. To address that difficulty, the FEDCORP would be governed by a presidentially appointed Board of Directors. DOE did not accept the findings of this report. In 2001, there was an update to the 1984 report.<sup>27</sup> Again the updated report recommended a FEDCORP approach once the program was ready to construct the repository; in addition the report suggested a number of funding approaches that would better connect expenditures of the program to its revenue sources. The challenge of how to structure the program to provide the long-term program continuity given short-term political forces has been a central theme of efforts to develop a viable repository program.<sup>28</sup>

## BOREHOLE DISPOSAL

There are three methods of geological isolation based on depth of burial: open pit mining (<1 kilometer), mined geological disposal (<2 kilometer), and boreholes (2 to 10 kilometers). There is renewed interest in borehole disposal of wastes because advances in oil drilling technology allow construction of boreholes to depths significantly greater than is possible by conventional mining techniques.<sup>29</sup>

The major limitation is that the volume of materials that can be practically disposed of are limited and thus it is an option for SNF, HLW, and selected fission products/minor actinide disposal but would not be suitable for higher volumes of intermediate-level wastes that require geological disposal. The attractive features of borehole disposal include: a larger fraction of the world's geology is thought to be suitable for borehole disposal, the wastes may be more difficult to retrieve (a potential nonproliferation advantage), and the technology may offer superior isolation of wastes by a unique isolation mechanism. The salt concentration of groundwater and hence density of groundwater increases with depth. Deep dense salty groundwater does not mix with the less dense fresh water above it and thus there is no mechanism for water near the wastes with dissolved radionuclides to mix and migrate with fresh water. Significant R&D is required to determine technical viability.

The characteristics of borehole disposal create new fuel cycle options.

- ▣ *Separation and disposal.* There have been many proposals to separate troublesome radionuclides in SNF and transmute (destroy) them in a reactor to address waste management or nonproliferation (plutonium destruction) concerns. An alternative is separation and borehole disposal—an option that does not depend upon the nuclear properties of the radionuclide and can dispose of troublesome radionuclides in a single step immediately after separation. This applies to both open and closed fuel cycles.
- ▣ *Regional or small nation repositories.* Limited studies suggest that the economics of borehole disposal would enable small capacity disposal sites. This creates the option of regional repositories and may provide a technology better suited to countries with small nuclear power programs.

## CITATIONS AND NOTES

1. C Pereira, "Recycling of Used Nuclear Fuel," ACCA Chemistry Series on Nuclear Chemistry, Benedictine University, Lisle, October 7, 2008
2. Paul Scherrer Institut, *Comprehensive Assessment of Energy Systems (GaBe): Sustainability of Electric Supply Technologies under German Conditions: a Comparative Analysis*, PSI Bericht Nr. 04-15 (December 2004).
3. C. V. Chester and R. O. Chester, "Civil Defense Implications of the U.S. Nuclear Power Industry During a Large Nuclear War in the Year 2000," *Nuclear Technology*, **31**, pp. 326 (December 1976)
4. The expectation for a repository is that records of its existence will last as long as society lasts. If society collapses and rebuilds, the existence of a repository would be detected with the geotechnical survey equipment of the 1960's used by geologists to find mineral ore bodies.
5. J. Hamstra, "Radiotoxic Measure for Buried Solid Radioactive Waste," *Nuclear Safety*, **16**(2), 180-189 (1975)
6. B. L. Cohen, "High-Level Radioactive Waste from Light-Water Reactors," *Rev. Mod. Phys.*, **49**, 1-20 (1977).
7. International Atomic Energy Agency, *Safety Indicators in Different Time Frames for the Safety Assessment of Underground Radioactive Waste Repositories*, IAEA TECDOC-767 (1994)
8. O. J. Wick and M. O. Cloninger, *Comparison of Potential Radiological Consequences from a Spent Fuel Repository and Natural Uranium Deposits*, PNL-3540, Pacific Northwest National Laboratory, Richland, Washington (1980)

9. NAGRA, Nuclear Waste Management in Switzerland: Feasibility Studies and Safety Analyses, Project Report NGB 85-09 Baden, Switzerland (1985)
10. J. O. Liljenzin and J. Rydberg, Risks from Nuclear Wastes (Revised Edition), SKI Report 96:70, Swedish Nuclear Power Inspectorate, Stockholm, Sweden (1996)
11. "Spent Nuclear Fuel Reprocessing in France", Mycle Schneider and Yves Marignac, A research report of the International Panel on Fissile Materials, April 2008
12. U.S. Environmental Protection Agency, *Public Health and Environmental Radiation Protection Standards for Yucca Mountain, Nevada*, 40CFR Part 197, Washington D.C.
13. The maximum allowable radiation dose is to an individual living at the repository site boundary that drinks local groundwater and uses the local groundwater to grow the crops he eats.
14. P. Salter, M. Apte, and G. Smith, Alternative Indicators of Performance: Use of Radionuclides Fluxes, Concentrations, and Relative Radiotoxicity Indices as Alternative Measures of Safety.
15. A. P. Meshik, "The Workings of an Ancient Nuclear Reactor," *Scientific American* (October 2005)
16. U.S. Nuclear Regulatory Commission, Proposed Rule for the Disposal of High-Level Radioactive Wastes in a Proposed Geological Repository at Yucca Mountain, Nevada, 10CFR63, RIN 3150-AG04, Washington D.C. (1998).
17. U.S. National Research Council, Nuclear Wastes: Technologies for Separations and Transmutation (1996)
18. <http://www.wipp.energy.gov/>
19. National Academy of Science, *The Waste Isolation Pilot Plant: a Potential Solution for the Disposal of Transuranic Wastes* (1996)
20. N. Zacha, editor, Radwaste Solutions (entire issue), May/June 2009.
21. T. F. Lomenick, *The Siting Record: An Account of the Programs of Federal Agencies and Events That Have Led to the Selection of a Potential Site for a Geologic Repository for High-Level Radioactive Waste*, ORNL/TM-12940 (March 1996)
22. J. S. Walker, *The Road to Yucca Mountain*, University of California Press, 2009
23. The Nuclear Waste Policy Act of 1982, The Gramm-Rudman-Hollings Balanced Budget and Emergency Deficit Control Act of 1985, and The Omnibus Budget Reconciliation Act of 1993
24. The 1987 Amendments to the Nuclear Waste Policy Act of 1982.
25. M. Wald, "Is There a Place for Nuclear Waste", *Scientific American* (August 2009)
26. U.S. Department of Energy, "Managing Nuclear Waste – A Better Idea", DOE/NBM-5008164 (December 1984)
27. Alternative Means of Financing and Managing the Civilian Radioactive Waste Management Program
28. R. B. Stewart, "U.S. Nuclear Waste Law and Policy: Fixing a Bankrupt System", *New York University Environmental Law Journal*, **17**, 783-825 (2008).
29. B. Sapiie and M. Driscoll, *A Review of Geology-Related Aspects of Deep Borehole Disposal of Nuclear Waste*, MIT-NFC-TR-109, Massachusetts Institute of Technology (August 2009)



# Chapter 7 Appendix — Economics

## DEFINITION OF THE LEVELIZED COST OF ELECTRICITY (LCOE)

The methodology for calculating of the levelized cost of electricity (LCOE) for the Once-Through Cycle is by now a very familiar standard one. The methodology for fuel cycles with recycling is less familiar and not yet standardized. The difficulty arises because one output from one reactor becomes an input to another reactor—either separated plutonium in the Twice-Through Cycle or separated transuranics in the Fast Reactor Cycle. If there were an easily observable market price for these separated products, then it would be straightforward to use the same methodology employed for the Once-Through Cycle, adjusting the calculation to recognize the different outputs or inputs in a system with recycling and valuing these new inputs and outputs at this market price. However, since recycling is not yet a widely used technology, there is not yet a reliably quoted market price for these recycled products. We can, instead, impute to them a value based on the cost of separating the products and their value as recycled fuel. How to do this imputation is what has not yet become familiar or standardized. This appendix lays out the methodology we employed together with some of the rationale. A fuller case for the methodology and comparison with other methods used in other studies is provided in an on-line research report.<sup>1</sup>

Table 7A.1 provides a list of the key variables used in this Appendix.

### The Once-Through Cycle

The LCOE for the traditional, Once-Through Cycle is the formula:

$$\ell_1 = \frac{\int_A^B C_t e^{-Rt} dt}{\int_A^B Q_t e^{-Rt} dt}, \quad (7A.1)$$

where  $C_t$  denotes the full set of realized costs at each date  $t \in [A, B]$ ,  $Q_t$  denotes the time profile of electricity produced at each date  $t \in [A, B]$ , and  $R$  denotes the continuously compounded discount rate.<sup>2</sup> The costs include all costs from the purchase of the raw ore, the fabrication of the fuel, construction and operation of the nuclear reactor, and finally the disposal of the spent fuel.<sup>3</sup>



**Table 7A.1 List of Variables**

<b>ONCE-THROUGH CYCLE</b>	
$\ell_1$	LCOE for the Once-Through Cycle;
	$\ell_1 = f_1 + k_1 + m_1 + d_1$
$f_1$	front-end fuel cost, levelized in mill/kWh;
	$f_1 = u_1 + b_1$
$k_1$	reactor capital cost, inclusive of future maintenance, capital expenditures and decommissioning costs, levelized in mill/kWh;
$m_1$	non-fuel operating and maintenance cost, levelized in mill/kWh;
$d_1$	cost of disposal of spent UOX fuel, including the cost of interim storage and geologic repository, levelized in mill/kWh;
$u_1$	cost of the raw uranium, levelized in mill/kWh;
$b_1$	enrichment, conversion and fabrication cost for UOX, levelized in mill/kWh;
<b>TWICE-THROUGH CYCLE</b>	
$\ell_2$	LCOE for the Twice-Through Cycle;
$\ell_{2,1}(p)$	LCOE for the first reactor in the cycle, i.e, the reactor burning fresh fuel and sending its spent fuel for reprocessing; this is a function of the value attributed to the separated plutonium, $p$ ;
	$\ell_{2,1}(p) = f_{2,1} + k_{2,1} + m_{2,1} + d_{2,1}(p)$
$f_{2,1}$	front-end fuel cost for the first reactor in the cycle, levelized in mill/kWh;
$k_{2,1}$	reactor capital cost for the first reactor in the cycle, levelized in mill/kWh;
$m_{2,1}$	non-fuel operating and maintenance cost for the first reactor in the cycle, levelized in mill/kWh;
	cost of disposal of spent fuel, including the cost of reprocessing, disposal of high level wastes and credits for the separated uranium and plutonium, levelized in mill/kWh;
	$d_{2,1}(p) = s_{2,1} + w_{2,1} - u_{2,1} - z_{2,1}(p)$
$s_{2,1}$	reprocessing cost, inclusive of interim storage for the separated streams and of low and intermediate-level waste disposal, levelized in mill/kWh;
$w_{2,1}$	high level waste disposal cost, levelized in mill/kWh;
$u_{2,1}$	credit for the separated uranium, levelized in mill/kWh;
$z_{2,1}(p)$	credit for the separated plutonium, levelized in mill/kWh;
$\ell_{2,2}(p)$	LCOE for the second reactor in the cycle, i.e, the reactor burning recycled fuel; this is a function of the value attributed to the separated plutonium, $p$ ;
	$\ell_{2,2}(p) = f_{2,2}(p) + k_{2,2} + m_{2,2} + d_{2,2}$
$f_{2,2}(p)$	front-end fuel cost for the first reactor in the cycle, levelized in mill/kWh; this is a function of the value attributed to the separated plutonium, $p$ , used to fabricate the fuel;
	$f_{2,2}(p) = u_{2,2} + z_{2,2}(p) + b_{2,2}$
$k_{2,2}$	reactor capital cost for the second reactor in the cycle, levelized in mill/kWh;
$m_{2,2}$	non-fuel operating and maintenance cost for the second reactor in the cycle, levelized in mill/kWh;
$d_{2,2}$	cost of disposal of spent MOX fuel, levelized in mill/kWh;
$u_{2,2}$	cost of purchasing depleted uranium used in fabricated the recycled fuel, levelized in mill/kWh;
$z_{2,2}(p)$	cost of purchasing the separated plutonium used for fabricating the recycled fuel, levelized in mill/kWh;
$b_{2,2}$	cost of fabricating the recycled fuel, levelized in mill/kWh;
$p$	value attributed to the separated plutonium, \$/kg; variable is solved for in deriving the two LCOEs, $\ell_{2,1}(p)$ and $\ell_{2,2}(p)$ ;

*continued next page*

**Table 7A.1 List of Variables (continued)**

FAST REACTOR RECYCLE	
$\ell_3$	LCOE for the Fast Reactor Recycle;
$\ell_{3,L}(p)$	LCOE for the light water reactor in the cycle; this is a function of the value attributed to the separated transuranics, $p$ ;
	$\ell_{3,L}(p) = f_{3,L} + k_{3,L} + m_{3,L} + d_{3,L}(p)$
$f_{3,L}$	front-end fuel cost for the light water reactor in the cycle, levelized in mill/kWh;
	$f_{3,L} = u_{3,LA} + b_{3,L}$
$k_{3,L}$	reactor capital cost for the light water reactor in the cycle, levelized in mill/kWh;
$m_{3,L}$	non-fuel operating and maintenance cost for the light water reactor in the cycle, levelized in mill/kWh;
$d_{3,L}(p)$	cost of disposal of spent fuel, including the cost of reprocessing, disposal of high level wastes and credits for the separated transuranics and uranium mix, levelized in mill/kWh;
	$d_{3,L}(p) = s_{3,L} + w_{3,L} - u_{3,LB} - z_{3,L}(p)$
$u_{3,LA}$	cost of the raw uranium, levelized in mill/kWh;
$b_{3,L}$	enrichment, conversion and fabrication cost for UOX, levelized in mill/kWh;
$s_{3,L}$	reprocessing cost, levelized in mill/kWh;
$w_{3,L}$	high level waste disposal cost, levelized in mill/kWh;
$u_{3,LB}$	credit for the separated uranium, levelized in mill/kWh;
$z_{3,L}(p)$	credit for the separated transuranics, levelized in mill/kWh;
$\ell_{3,F}(p)$	LCOE for a fast reactor in the cycle; this is a function of the value attributed to the separated transuranics, $p$ , used to fabricate the fuel;
$f_{3,F}(p)$	front-end fuel cost for a fast reactor in the cycle, levelized in mill/kWh; this is a function of the value attributed to the separated transuranics, $p$ , used to fabricate the fuel;
	$f_{3,F}(p) = u_{3,FA} + z_{3,F}(p) + b_{3,F}$
$k_{3,F}$	reactor capital cost for a fast reactor in the cycle, levelized in mill/kWh;
$m_{3,F}$	non-fuel operating and maintenance cost for a fast reactor in the cycle, levelized in mill/kWh;
$d_{3,F}(p)$	cost of disposal of spent fuel, including the cost of reprocessing, disposal of high level wastes and credits for the separated transuranics and uranium mix, levelized in mill/kWh;
	$d_{3,F}(p) = s_{3,F} + w_{3,F} - u_{3,FB} - \alpha z_{3,F}(p)$
$u_{3,FA}$	cost of purchasing depleted uranium used in fabricated the fast reactor fuel, levelized in mill/kWh;
$z_{3,F}(p)$	cost of purchasing the separated transuranics used for fabricating the fast reactor fuel, levelized in mill/kWh;
$b_{3,F}$	cost of fabricating the fast reactor fuel, levelized in mill/kWh;
$s_{3,F}$	reprocessing cost for fast reactor fuel, inclusive of interim storage for the separated streams and of low and intermediate-level waste disposal, levelized in mill/kWh;
$w_{3,F}$	high level waste disposal cost, levelized in mill/kWh;
$u_{3,FB}$	credit for the separated uranium, levelized in mill/kWh;
$z_{3,F}(p)$	credit for the separated transuranics, levelized in mill/kWh;
$\alpha$	the TRU mass ratio (i.e. the ratio of the mass of TRU in fast reactor spent fuel to the mass of TRU in fresh fuel) adjusted for the present value difference between when the fuel is initially loaded and when it is next loaded;
	$\alpha = (q_2/q_1)e^{-R(B_2-B_1)}$ , where $q_2/q_1$ is the TRU mass ratio, $B_1$ is the date of loading of the fuel into the first fast reactor and $B_2$ is the date of loading of the recycled transuranics from the first fast reactor into a second fast reactor; $R$ is the continuously compounded annual rate of interest;
$p$	value attributed to the separated transuranics, \$/kg; variable is solved for in deriving the two LCOEs, $\ell_{3,L}(p)$ and $\ell_{3,F}(p)$ ;

## The Twice-Through Cycle

The LCOE for the Twice-Through Cycle is similar to equation (7A.1), except that we have to represent the costs incurred and electricity produced for both the first pass with fresh UOX fuel through a reactor and the second pass with the recycled, MOX fuel through a second reactor. So the numerator of our formula will show two profiles of costs, and the denominator will show two profiles of electricity production:

$$\ell_2 = \frac{\int_{A_1}^{B_1} C_{1t} e^{-Rt} dt + \int_{A_2}^{B_2} C_{2t} e^{-Rt} dt}{\int_{A_1}^{B_1} Q_{1t} e^{-Rt} dt + \int_{A_2}^{B_2} Q_{2t} e^{-Rt} dt} \quad (7A.2)$$

The subscript 1 denotes the first pass with fresh UOX fuel, while the subscript 2 denotes the second pass with recycled, MOX fuel. The window of time  $[A_1, B_1]$  encompasses the electricity produced in the first reactor using the fresh UOX fuel, while the window of time  $[A_2, B_2]$  encompasses the electricity produced in the second reactor using the recycled, MOX fuel. Correspondingly,  $C_{1t}$  denotes the full set of realized costs related to the electricity produced in the first reactor,  $C_{2t}$  denotes the full set of realized costs related to the electricity produced in the second reactor, and  $Q_{1t}$  denotes the time profile of electricity produced in the first reactor, while  $Q_{2t}$  denotes the time profile of electricity produced in the second reactor.

The full set of realized costs will include the costs of reprocessing the fuel at the end of the first pass, including any storage costs, the costs of disposing of any separated waste stream that will not be passed along to the second reactor, the costs of fabricating the MOX fuel from the plutonium that is passed along from the first reactor to the second, and the cost of disposing of the spent MOX at the conclusion of the second pass. It is arbitrary whether the costs of reprocessing and MOX fuel fabrication are assigned to the first or to the second reactor, since the definition of the LCOE depends only upon the total costs for the complete pair of passes. We choose to assign the reprocessing costs to the first reactor, and the MOX fabrication costs to the second reactor. This allocation does not impact any of the results, only the form in which they are presented.

Our definition of the LCOE looks at the whole cycle. Costs incurred at any point in the cycle—whether during the first pass of fresh UOX fuel, or in the reprocessing of the spent fuel and fabrication of the MOX fuel, or in the second pass with the MOX fuel—are levelized across the electricity produced throughout the full cycle, by both passes of the fuel.

### *The Price of the Recycled Elements – Plutonium*

Equation (7A.2) does not include any explicit assessment of the value or price of the recovered plutonium passed from one reactor to another. The LCOE is defined independently of whatever price one might assign to the recovered plutonium, since the cost to one reactor would be exactly cancelled out in the equation as a credit to the other reactor. Of course, by attributing a price to the plutonium,  $p$ , one can decompose the LCOE of the cycle into two separate LCOEs, one for the electricity produced from the first pass reactor and one for the electricity produced from the second pass reactor:

$$\ell_{2,1}(p) = \frac{\left( \int_{A_1}^{B_1} C_{1t} e^{-Rt} dt - qp e^{-RB_1} \right)}{\int_{A_1}^{B_1} Q_{1t} e^{-Rt} dt}, \quad (7A.3)$$

and,

$$\ell_{2,2}(p) = \frac{\left( +qp e^{-RB_1} + \int_{A_2}^{B_2} C_{2t} e^{-Rt} dt \right)}{\int_{A_2}^{B_2} Q_{2t} e^{-Rt} dt} \quad (7A.4)$$

There is a unique  $p^*$  such that these two LCOEs equal one another, and are equal to the LCOE for the cycle as a whole:

$$\ell_2 = \ell_{2,1}(p^*) = \ell_{2,2}(p^*). \quad (7A.5)$$

This condition is what we use to determine the price of plutonium for the cycle.<sup>4</sup>

### The Fast Reactor Recycle

In recycling of spent fuel through fast reactors, the process of passing along a portion of the original fuel to the next reactor is repeated ad infinitum. A truly complete LCOE calculation requires a full accounting of the infinite chain of costs incurred as the packet of fuel moves from one reactor to the next. So the numerator of our formula will now show an infinite chain of profiles of costs, and the denominator will show an infinite chain of profiles of electricity production. Let subscript  $j$  index the passes through a reactor, with  $j=1$  referring to the initial pass through the light water reactor with fresh UOX fuel, and  $j=2,3,4,\dots$  referring to the subsequent passes through fast reactors using fast reactor fuel fabricated using recycled transuranics. The window of time  $[A_j, B_j]$  encompasses the electricity produced in the  $j^{\text{th}}$  pass through a reactor,  $C_{jt}$  denotes the full set of realized costs in pass  $j$  at date  $t$ , and  $Q_{jt}$  denotes the time profile of electricity produced in pass  $j$  at date  $t$ . Then the LCOE for the Fast Reactor Recycle is given by:

$$\ell_3 = \frac{\sum_{j=1}^{\infty} \left[ \int_{A_j}^{B_j} C_{jt} e^{-Rt} dt \right]}{\sum_{j=1}^{\infty} \left[ \int_{A_j}^{B_j} Q_{jt} e^{-Rt} dt \right]}. \quad (7A.6)$$

A proper representation of the chain of costs in a full actinide recycling system is very complex. Each pass through a reactor changes the isotopic composition of the fuel. In particular, the vector of uranium and transuranic elements is changing with each pass, only gradually approaching an equilibrium vector. The isotopic composition determines the neutronic behavior which must be taken into account in fabricating the new fuel at each stage, changing the costs at each pass. A proper calculation of the levelized cost for the cycle as a whole must account for the complete profile of these changing costs through time, requiring a unique assessment of  $C_{jt}$  for each  $j$ .

The levelized cost formula in equation (7A.6) can be greatly simplified if we assume that the vector of transuranics is constant through all of the fast reactor cycles, as if the equilibrium vector were reached at the extraction of the transuranics from the light water reactor. We then assume that all of the various costs at each fast reactor cycle scale according to the transuranics mass ratio,  $q_2/q_1$ , which measures the quantity of the transuranics exiting the cycle relative to the quantity entering the cycle. This ratio is linked to but different from the conversion ratio by which fast reactors are usually labeled.<sup>5</sup> Under this constant transuranics vector assumption, the present value of the costs at each pass through a fast reactor is a simple scaling of the costs at the first pass in fast reactors, with the scaling factor being

$$\alpha^{j-2} = \left( \frac{q_2}{q_1} e^{-R(B_2-B_1)} \right)^{j-2}. \quad (7A.7)$$

Consequently, the infinite chain of distinct cost calculations can be reduced to one involving only two cycles with different cost elements:

$$\ell_3 = \frac{\int_{A_1}^{B_1} C_{1t} e^{-Rt} dt + \sum_{j=2}^{\infty} \alpha^{j-2} \left( \int_{A_2}^{B_2} C_{2t} e^{-Rt} dt \right)}{\int_{A_1}^{B_1} Q_{1t} e^{-Rt} dt + \sum_{j=2}^{\infty} \alpha^{j-2} \left( \int_{A_2}^{B_2} Q_{2t} e^{-Rt} dt \right)}.$$

Assuming  $\alpha < 1$ , which will be true in the cycles we examine, this equation, collapses to,

$$\ell_3 = \frac{\int_{A_1}^{B_1} C_{1t} e^{-Rt} dt + \frac{1}{1-\alpha} \int_{A_2}^{B_2} C_{2t} e^{-Rt} dt}{\int_{A_1}^{B_1} Q_{1t} e^{-Rt} dt + \frac{1}{1-\alpha} \int_{A_2}^{B_2} Q_{2t} e^{-Rt} dt}. \quad (7A.8)$$

Given the large uncertainties involved in estimating major elements of the total cost for the recycle technology, this approximation seems reasonable.

### The Price of the Recycled Elements – the Transuranics

Paralleling our earlier solution for an attributed price of plutonium, we now derive an attributed value for the transuranics passed from one cycle to another.<sup>6</sup> An arbitrary price for the transuranics,  $p$ , decomposes the LCOE for the cycle as a whole into a pair of LCOEs, one for the initial pass—through a light water reactor—and one for the succeeding passes—through a fast reactor:

$$\ell_{3,L}(p) = \frac{\left( \int_{A_1}^{B_1} C_{1t} e^{-Rt} dt - q_1 p e^{-RB_1} \right)}{\int_{A_1}^{B_1} Q_{1t} e^{-Rt} dt}, \quad (7A.9)$$

$$\ell_{3,F}(p) = \frac{\left( q_1 p e^{-RB_1} + \int_{A_2}^{B_2} C_{2t} e^{-Rt} dt - \alpha q_1 p e^{-RB_2} \right)}{\int_{A_2}^{B_2} Q_{2t} e^{-Rt} dt}. \quad (7A.10)$$

Define by  $p^*$  the unique attributed value of the transuranics such that the LCOE for each pass is the same as the LCOE calculated for the entire cycle:

$$\ell_3 = \ell_{3,L}(p^*) = \ell_{3,F}(p^*). \quad (7A.11)$$

### LCOE BY COMPONENT

For each fuel cycle we factor the LCOE into components:  $f$  denotes levelized cost of the front-end of the fuel cycle, including the raw ore, conversion, enrichment and fabrication,  $k$  is the capital charge for the light water reactor,  $m$  is the operating and maintenance charge for the reactor, and  $d$  is the cost associated with the back-end of the fuel cycle, whether disposal, including any above-ground storage and final geologic sequestration, or reprocessing. All four cost components are represented as a charge per kWh levied as the electricity is produced. Each charge is calculated to be sufficient, in present value terms, to cover the actual respective cash flows for each activity at the time the cash flow is incurred.

We write the LCOE for the Once-Through Cycle as:

$$\ell_1 = f_1 + k_1 + m_1 + d_1, \quad (7A.12)$$

where the subscript 1 attached to each variable denotes the Once-Through Cycle. For later comparison purposes, it will be useful to write the front-end cost as the sum of the cost of raw uranium,  $u_1$ , and the sum of the enrichment, conversion, and fabrication costs,  $b_1$ , with  $f_1 = u_1 + b_1$ . The values for the LCOE, the four main components and the breakdown of the front-end fuel cycle costs are shown in Table 7.2 in the main chapter.

In the Twice-Through Cycle, the pair of LCOEs is written as:

$$\ell_{2,1}(p) = f_{2,1} + k_{2,1} + m_{2,1} + d_{2,1}(p), \quad (7A.13)$$

$$\ell_{2,2}(p) = f_{2,2}(p) + k_{2,2} + m_{2,2} + d_{2,2}, \quad (7A.14)$$

where the first subscript, 2, attached to each variable denotes the Twice-Through Cycle, and the second subscript, either 1 or 2, denotes the reactor within the cycle. By definition,  $f_{2,1} = f_1$ ,  $k_{2,1} = k_1$  and  $m_{2,1} = m_1$ . We also assume that  $k_{2,2} = k_{2,1}$  and  $m_{2,2} = m_{2,1}$ , although in general this need not be the case. The back-end fuel cycle cost for the first reactor in the Twice-Through Cycle is decomposed as:

$$d_{2,1}(p) = s_{2,1} + w_{2,1} - u_{2,1} - z_{2,1}(p), \quad (7A.15)$$

where  $s_{2,1}$  is the levelized reprocessing cost,  $w_{2,1}$  is the levelized cost of disposal of the separated high level waste stream,  $u_{2,1}$  is the levelized credit for the recovered reprocessed uranium, and  $z_{2,1}$  is the levelized value of the separated plutonium. This last component is measured per kWh of electricity produced in the first reactor and is a function of the attributed value of plutonium,  $p$ , measured per kgHM. The front-end fuel costs for the second reactor is decomposed as:

$$f_{2,2}(p) = u_{2,2} + z_{2,2}(p) + b_{2,2}, \quad (7A.16)$$

where  $u_{2,2}$  is the levelized cost for the depleted uranium used in the MOX fuel,  $z_{2,2}$  is the levelized value of the separated plutonium used in the MOX fuel, and  $b_{2,2}$  is the levelized cost of fabricating the MOX fuel. The levelized value of the separated plutonium is measured per kWh of electricity produced in the second reactor and is a function of the attributed value of plutonium,  $p$ , measured per kgHM. The back-end cost of the second reactor,  $d_{2,2}$ , does not depend on the value of separated plutonium, but is equal to the fixed interim storage and the disposal costs for spent MOX. All of these components shown in Table 7.3 in the main chapter, together with the pair of total LCOEs,  $\ell_{2,1}$  and  $\ell_{2,2}$ .

In the Fast Reactor Recycle, the pair of LCOEs is written as:

$$\ell_{3,L}(p) = f_{3,L} + k_{3,L} + m_{3,L} + d_{3,L}(p), \quad (7A.17)$$

$$\ell_{3,F}(p) = f_{3,F}(p) + k_{3,F} + m_{3,F} + d_{3,F}(p), \quad (7A.18)$$

where the first subscript, 3, attached to each variable denotes the Fast Reactor Recycle, and the second subscript, either  $L$  or  $F$ , denotes the reactor within the cycle. In our Fast Reactor Recycle, the initial pass through the light water reactor is the same as in the Once-Through Cycle, up to disposal. Therefore,  $f_{3,L} = f_1$ ,  $k_{3,L} = k_1$  and  $m_{3,L} = m_1$ . The back-end fuel cycle cost for the first reactor in the Fast Reactor Recycle is decomposed as:

$$d_{3,L}(p) = s_{3,L} + w_{3,L} - u_{3,L} - z_{3,L}(p), \quad (7A.19)$$

where  $s_{3,L}$  is the levelized reprocessing cost,  $w_{3,L}$  is the levelized cost of disposal of the separated high level waste stream,  $u_{3,L}$  is the levelized credit for the recovered reprocessed

uranium, and  $z_{3,L}$  is the levelized value of the separated transuranics. This last component is measured per kWh of electricity produced in the first reactor and is a function of the attributed value of transuranics,  $p$ , measured per kgHM. The front-end fuel costs for the fast reactor is decomposed as:

$$f_{3,F}(p) = u_{3,FA} + z_{3,F}(p) + b_{3,F} \quad (7A.20)$$

where  $u_{3,FA}$  is the levelized value of the depleted uranium contained in the fast reactor fuel,  $z_{3,F}$  is the levelized value of the transuranics contained in the fast reactor fuel, and  $b_{3,F}$  is the cost of fabricating the fast reactor fuel. The levelized value of the transuranics in the fast reactor fuel is measured per kWh of electricity produced in the fast reactor and is a function of the attributed value of the separated transuranics,  $p$ , measured per kgHM. The cost of disposing of the spent fuel from the fast reactor is:

$$d_{3,F}(p) = s_{3,F} + w_{3,F} - u_{3,FB} - \alpha z_{3,F}(p), \quad (7A.21)$$

where  $s_{3,F}$  is the levelized reprocessing cost for fast reactor fuel,  $w_{3,F}$  is the levelized cost of disposal of the separated high level waste stream,  $u_{3,FB}$  is the levelized credit for the recovered reprocessed uranium,  $z_{3,F}$  is the levelized value of the separated transuranics, and the parameter  $\alpha$  is given by equation (7A.7) above. The levelized value of the transuranics is measured per kWh of electricity produced in the fast reactor and is a function of the attributed value of the separated transuranics,  $p$ , measured per kgHM. These various components of the LCOEs for the Fast Reactor Cycle are shown in Table 7.4 in the main chapter, together with the pair of total LCOEs,  $\ell_{3,L}$  and  $\ell_{3,F}$ .

## IMPLEMENTATION

This section of the Appendix explains how the LCOE calculations are executed. Table 7.1 in the main text lists our assumptions for the many inputs to the levelized cost calculations for each cycle. Table 7A.2–7A.4 provide some additional detail on the engineering assumptions for each cycle. The characteristics of the cycles correspond to those described in Chapter 6 and in more detail in an on-line research report.<sup>7</sup>

All of the input costs are assumed to be constant in real terms. This is a common assumption in calculations of the LCOE from alternative generating technologies, but not a necessary one.<sup>8</sup> Indeed, it is an assumption that is worth questioning precisely when analyzing alternative nuclear fuel cycles, since a key argument in favor of recycling is concern that the scarcity of the raw materials relative to the exponentially growing demand for electricity that will drive the price of the fuel to escalate more rapidly than the general inflation rate. Our assumption that real prices are constant is critical for the way that we allocate costs across components of a cycle that follow one another in time. Nevertheless, forecasting the time profile of any of the input costs is a perilous exercise which we did not embark on here.

In our 2009 *Update of the 2003 Future of Nuclear Power* Report we calculated the LCOE for the Once-Through Cycle using a nominal Weighted Average Cost of Capital of 10% and an inflation rate of 3%. The calculations in this report are done in real terms. The equivalent real Weighted Average Cost of Capital is 7.6%. This is an annual discount rate. The equivalent continuously compounded discount rate is 7.3%.



Burn-up	50	MWd/kgHM
Cycle length	1.5	years
Core mass, UOX	84.7	MTHM/GWe
Fuel batches	3	
Fuel batch residence time	4.5	years
Thermal efficiency	33%	
Generation per kgHM UOX	10.04	kWe
Loss during conversion	0.2%	
Loss during enrichment	0.2%	
Loss during fabrication	0.2%	
Lead time for ore purchase	2	years
Lead time for conversion	1.5	years
Lead time for fabrication	0.5	years
Enrichment of UOX	4.5%	
Optimum Tails Assay	0.29%	
Feed	10.05	(initial kgU/enriched kgU)
Separative Work Units	6.37	
Reactor life	40	years
Incremental capital costs	40	\$ million/GWe/year
Decommissioning cost	700	\$ million/GWe
Fixed O&M Costs	56.44	\$/kW/year
Variable O&M Costs	0.42	mills/kWh
Depreciation, MACRS schedule	15	years
Tax rate	37%	
Spent fuel pool storage period	5	years

In most other studies that calculate the LCOE for the Once-Through Cycle, the time frame most commonly used,  $[A,B]$ , is the useful life of a single reactor—e.g. 40 years—with allowances at the front-end for the construction period and at the back-end for dismantling. Separate calculations will have been made to take costs incurred outside of this time frame—such as the cost of preparing a disposal site or the costs of constructing a reprocessing facility—which translate these expenditures into a levelized charge paid within the time frame  $[A,B]$ . So long as all costs are accounted for and present valued in a consistent fashion, it is immaterial what reference time frame is employed. In our calculations,  $[A_j, B_j]$  is the time that a unit of fuel is resident in a reactor—e.g. 4.5 years—together with buffer periods at the loading and unloading when the relevant fabrication and interim storage operations occur. This time frame is much shorter than the life of the reactor, so we treat reactor costs in the same way that the usual calculation treats disposal costs: in a side calculation we determine a rental charge for the reactor that must be paid while the fuel is resident, i.e. for  $t \in [A_j, B_j]$ . This charge is set so that the combined rental fees paid by all of the units of fuel resident over the life of the reactor equal the cost of the reactor in present value terms.

### Once-Through Cycle

Table 7A.2 shows the key engineering and other economic assumptions used to calculate the LCOE for the Once-Through Cycle.

To illustrate how we calculate the levelized cost components, we calculate the levelized cost of the raw uranium,  $u_1$ , as follows. Based on our assumptions, in order to have 1 kgHM of UOX fuel we require 10.05 kgHM of fresh uranium ore (yellowcake) at the assumed price of \$80/kgHM, which is converted into 10.03 kgHM of uranium hexafluoride. We assume a 2-year lead time for ore purchase. Given our assumptions, each kgHM of UOX fuel has the effective electricity generating capacity of 10.04 kWe throughout the 4.5 years it is resident in the core. With 8,766 hours in a year, this enables us to calculate the levelized cost of raw uranium per unit of electricity produced as:

$$u_1 = \left( \frac{(\$80)(10.05)}{(1+r)^{-2}} \right) \bigg/ \left( 10.04 \int_0^{4.5} 8,766 e^{-Rt} dt \right) = 2.76 \text{ mill/kWh,}$$

where  $r$  is the annual discount rate and  $R$  is the continuously compounded discount rate. Similar calculations for the other components give the values reported in Table 7.2 in the main chapter.

## Twice-Through Cycle

Table 7A.3 shows the key engineering and other economic assumptions used to calculate the LCOE for the Twice-Through Cycle. The calculations of the levelized costs for the various components are conducted in exactly the fashion as described immediately above. However, since the Twice-Through Cycle involves the expression of the cost and credit for the separated plutonium, we detail that calculation in particular, and we show how the value for the separated plutonium is derived. Also, because the cost of disposing of the spent MOX is critical to the final LCOE, we explain that calculation in some detail.

### *Reprocessing and Fuel Fabrication Costs as a Function of the Value of Separated Plutonium*

Each 1kg of spent UOX leads to the separation of 0.011kg of plutonium. We denote the attributed price of plutonium as  $p$ , denominated in \$/kgHM, and then calculate the total attributed value to the separated plutonium, measured per unit of electricity originally produced by the fuel being reprocessed as:

$$z_{2,1}(p) = \frac{p(0.011)}{(1+r)^{10.5}} \left/ \left( 10.04 \int_0^{4.5} 8,766 e^{-Rt} dt \right) \right. = 1.57 \cdot 10^{-5} p \text{ mill/kWh.}$$

We leave this value expressed as a function of the as yet unspecified attributed price of plutonium,  $p$ . This is solved for below.

By a similar calculation for the second reactor which is fed with MOX fuel fabricated from the separated plutonium, and assuming that 8.73% of the fuel by weight is composed of plutonium and Americium coming from spent UOX, we have:

$$z_{2,2}(p) = \frac{p(0.0875 \text{ kgHM})}{(1+r)^{-1}} \left/ \left( 10.04 \int_0^{4.5} 8,766 e^{-Rt} dt \right) \right. = 2.79 \cdot 10^{-4} p \text{ mill/kWh.}$$

### *The Second Reactor Back-end Fuel Cycle Cost*

We assume that after a period of temporary storage the spent MOX will be sent to a geological repository just as we had assumed for the spent UOX in the Once-Through Cycle. We base our calculation of the cost of disposal of the spent MOX off of the cost of disposal of spent UOX. This had included two parts: a cost of above-ground storage equal to \$200/kgiHM, and a cost of disposal in a geological repository equal to \$470/kgiHM. The \$470/kgiHM cost for disposal is derived from the current 1 mill/kWh statutory charge to be paid 5 years after unloading of the fuel. For spent MOX we assume the identical cost for the

**Table 7A.3 Twice-Through Fuel Cycle Specifications**

FIRST REACTOR, BURNING UOX		
Front-end fuel parameters	same as OTC	
Reactor capital costs	same as OTC	
Reactor operating costs	same as OTC	
Spent fuel pool storage period	same as OTC	
Loss during reprocessing (U & Pu)	0.2%	
Reprocessed uranium recovered	0.930	kgHM/kgiHM
Plutonium recovered	0.011	kgHM/kgiHM
Enrichment target for reprocessed U	5.16%	
Optimum Tails Assay for reprocessed U	0.39%	
Feed for reprocessed U	7.63	(initial kgU/enriched kgU)
Separative Work Units for reprocessed U	4.80	
Price of Reprocessed U from UOX	108.30	\$/kgHM
SECOND REACTOR, BURNING UOX AND MOX		
Loss during MOX fabrication	0.2%	
U-235 content of depleted uranium	0.25%	
Depleted uranium required as % weight	91.3%	
Plutonium required as % weight	8.6%	
Lead time for plutonium separation	2 years	
Americium as % weight	0.1%	
Reactor capital costs	same as OTC	
Reactor operating costs	same as OTC	

above ground storage. However, the cost of disposal in a geological repository is higher for spent MOX fuel since the composition of the fuel is different. There are many factors that go into determining how the design and scale of the repository would need to be different, and the ultimate variation in cost will depend on many elements of the design changes. The required volume of space is only one metric. Nevertheless, the change in space requirements needed to handle the heat load is often used as a key indicator. Since no geologic repository for spent MOX has actually ever been designed, this indicator is left as the best starting point for estimating the cost differential for disposal of spent MOX relative to the disposal of spent UOX. The BCG study (2006) produced for Areva estimates a densification factor of 0.15, meaning that 150g of spent MOX would take up as much space in a repository as 1 kg of spent UOX fuel, i.e. 6.67 times the space per kgHM. We apply this factor to determine the cost of disposal in a geologic repository for spent MOX fuel, \$3,130/kgHM. Therefore, for the second reactor, the total levelized back-end cost, measured per unit of electricity produced is:

$$d_{2,2} = \frac{\$200 + (\$677 / 0.15)}{(1+r)^{9.5}} \bigg/ \left( 10.04 \int_0^{4.5} 8,766 e^{-Rt} dt \right) = 6.96 \text{ mill/kWh.}$$

#### *The Value of Plutonium and the LCOE for the Twice-Through Cycle*

We solve for the attributed value of plutonium by filling in the values of equations (7A.13) and (7A.14) and then applying the condition in equation (7A.5):

$$\begin{aligned} \ell_{2,1}(p^*) &= 7.11 + 67.68 + 7.72 + (2.36 + 0.40 - 0.14 - 1.57 \times 10^{-5} p) \\ &= (0.03 + 2.79 \times 10^{-4} p + 7.38) + 67.68 + 7.72 + 6.96 = \ell_{2,2}(p^*). \end{aligned}$$

We find that  $p^* = -15,734$  \$/kgHM, so that,

$$z_{2,1}(p^*) = 0.25 \text{ mill/kWh,}$$

$$d_{2,1}(p^*) = 2.87 \text{ mill/kWh,}$$

$$z_{2,2}(p^*) = -4.39 \text{ mill/kWh,}$$

and,

$$f_{2,2}(p^*) = 3.02 \text{ mill/kWh,}$$

and,

$$\ell_{2,1}(p^*) = \ell_{2,2}(p^*) = 85.38 \text{ mill/kWh.}$$

## Fast Reactor Recycle

Table 7A.4 shows the key engineering and other economic assumptions used to calculate the LCOE for the Fast Reactor Recycle. The calculations of the levelized costs for the various components are conducted in exactly the fashion as described above. The cost and credit for the separated transuranics is calculated in the same fashion as was just illustrated for the separated plutonium in the Twice-Through Cycle.

<b>LWR REACTOR</b>		
Front-end fuel parameters	same as OTC	
Reactor capital costs	same as OTC	
Reactor operating costs	same as OTC	
Spent fuel storage period	same as OTC	
Loss during reprocessing (TRU)	0.2%	
Reprocessed uranium recovered	0.93	kgHM/kgiHM
TRU recovered	0.013	kgHM/kgiHM
<b>FAST REACTOR</b>		
Burn-up	73	MWd/kgHM
Cycle length	1.2	years
Core mass	43.4	MTHM/GWe
Fuel batches	5	
Fuel batch residence time, average	4.2	years
Thermal efficiency	41%	
Generation per kgHM FR fuel	19.57	kWe
Loss during FR fuel fabrication	0.2%	
Depleted uranium required as % weight	86.1%	
TRU required as % weight	13.9%	
Depleted uranium recovered	0.78	kgHM/kgiHM
TRU recovered	0.14	kgHM/kgiHM

## CITATIONS AND NOTES

1. The methodology is described in the Appendix. A more detailed presentation appears in De Roo, Guillaume, and John E. Parsons, A Methodology for Calculating the Levelized Cost of Electricity in Nuclear Power Systems with Fuel Recycling, *Energy Economics*, forthcoming 2011, doi 10.1016/j.eneco.2011.01.008. Although a few parameter inputs vary, the calculations follow by exactly the same steps. A spreadsheet containing the detailed calculations is available on the web for download at [http://web.mit.edu/ceepr/www/publications/workingpapers/DeRooParsons\\_spreadsheet.xls](http://web.mit.edu/ceepr/www/publications/workingpapers/DeRooParsons_spreadsheet.xls).
2. In implementing the calculations we often have occasion to utilize the equivalent annually compounded discount rate,  $r \equiv \exp(R) - 1$ .
3. For economy of notation we write this and other formulas as if expenditures and production of electricity occur continuously over time. Some readers may be more familiar with a version of the formulas in which expenditures and production are expressed annually. Nothing of substance changes when one does the calculation this other way. One just has to implement the appropriate redenomination of key variables. For example, the interest rate needs to be translated from a continuously compounded variable to an annually compounded variable.
4. We calculate the value of the uranium recovered from the spent fuel at the conclusion of the first pass with reference to the assumed cost of fresh uranium and the differential cost of fabricating 'equivalent' UOX fuel using reprocessed uranium.
5. The conversion ratio is the ratio of the rate of production of new fissile transuranics to the rate of fissile transuranics consumption by the neutron chain reaction. At equilibrium, if the transuranics mass ratio is equal to one, then the conversion ratio is also equal to one. Around this point, the two ratios move together, with the conversion ratio having a greater amplitude than the transuranics mass ratio.
6. In fact, it is not really the transuranics that are exchanged from one step of the cycle to another, but more generally, a mix of transuranics and depleted uranium. Hence we should consider a price for the mix. But since at each step, the new fuel can be obtained by addition of depleted uranium or transuranics to the mix, we can show that the value of the mix is equal to the value of its separated elements. In our calculations, the price of depleted uranium is given as an input parameter. Therefore, we can extract and reason with a price for the transuranics alone.
7. Guérin, L. and M. S. Kazimi, Impact of Alternative Nuclear Fuel Cycle Options on Infrastructure and Fuel Requirements, Actinide and Waste Inventories, and Economics, MIT-NFC-TR-111, MIT, September 2009.
8. For example, the MIT (2003) study of *The Future of Nuclear Power* assumes different rates of inflation for maintenance capital expenditures, operating costs, fuel costs and electricity when calculating its LCOEs for a nuclear power plant.

# Appendix A — Thorium Fuel Cycle Options

Thorium has been considered as a nuclear fuel since the very beginning of the atomic energy era. However, its use in early reactors, whether light-water cooled or gas cooled, has not led any commercial nuclear reactors to operate on a thorium cycle. The primary difficulty with the use of thorium arises from the fact that it occurs in nature exclusively as Th-232 which is not a fissile isotope, whether by a fast or a thermal neutron. It still represents a valuable energy resource because, if irradiated with neutrons, Th-232 is converted into U-233, which is an exceptionally good fissile isotope. The process of conversion is similar to that of converting U-238 into Pu-239 and presented in Figure A.1.

**Figure A.1 Conversion of fertile isotopes**

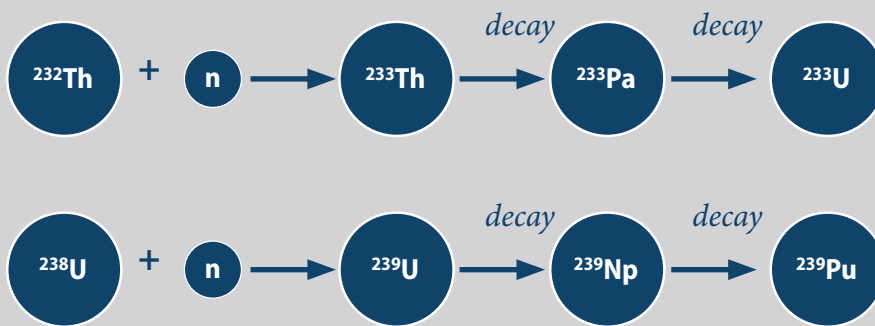

The requirement of an initial neutron investment before thorium can become useful and generate energy implies that a fissile isotope originating from some other source should be part of a thorium fueled reactor in order to supply these initial neutrons. Practical choices for the initial fissile fuel component include enriched uranium, plutonium separated from the spent fuel of a uranium cycle, or dismantled nuclear weapons, or U-233 separated from irradiated thorium. The practical implication is that there would be a very long time delay before thorium fuels could make a significant contribution to U.S. energy needs under any circumstance.

The use of thorium in a U-Th fuel cycle in reactors has been investigated since the early days of nuclear power development, and is the subject of periodic reviews [e.g. Kazimi, 2003]. Most of the recent work has been done in India—a country with limited uranium resources but very large thorium resources. Assessment of the Pu-Th fuel cycle for reactors started to appear only in the 1990s, with the availability of discarded Pu from the military programs. Driving a non-critical reactor with thorium by neutrons supplied from accelerator targets [Rubia et al., 1995] or a fusion device [Lidsky, 1975] has also been proposed to provide U-233 to power reactors, but such options are at present too expensive to be of use to commercial power generation.

Historically, the interest in thorium was driven by one of the following objectives:

- extension of nuclear energy fuel resources
- reduction of existing separated Pu stockpile
- reduction of Pu content in the nuclear fuel cycle to improve its proliferation resistance
- improving the characteristics of waste, particularly with regards to the long term content of radioactive actinides.

The potential of meeting these objectives is discussed here in some detail.

## AVAILABILITY OF NUCLEAR FUEL

Thorium is estimated to be about three times as abundant in the Earth's crust as uranium. Therefore, effective utilization of Th in the nuclear fuel cycle would significantly increase fuel availability for fission reactors in the future. It is also thought to be a route for achieving energy independence for countries with large thorium but limited uranium reserves, such as India and Brazil.

The traditional approach to solving the nuclear fuel availability problem has been through developing fast spectrum breeder reactors, which can generate fissile material at the same or a faster rate than they consume it. The physical phenomenon that makes the utilization of fast reactors more favorable than thermal reactors, such as today's light water reactors, is the fact that more neutrons become available for breeding new fissile material if the average energy of neutrons causing the fission becomes higher than about 100 keV. This fact is illustrated in Figure A.2, which shows the average number of neutrons released in fission from various isotopes per neutron absorbed as a function of the absorbed neutron energy.

**Figure A.2 Fission neutron yield per absorption for various fissile isotopes**

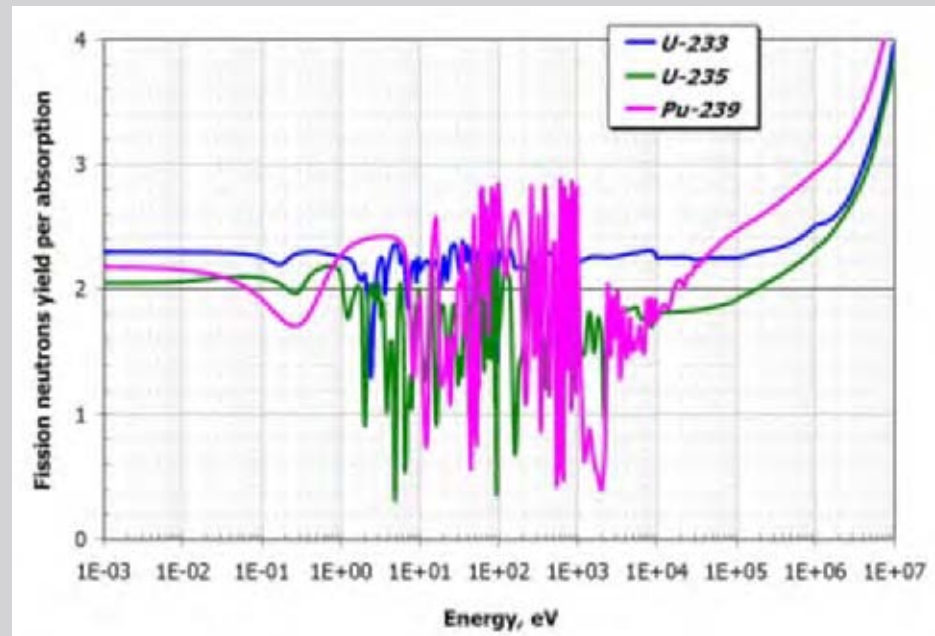

As can be observed from Figure A.2, all common fissile isotopes exhibit a similar increase in the number of neutrons available for breeding at high energies. However, for Uranium-233, unlike U-235 and Pu-239, the number of neutrons released per absorption in the thermal neutron energy region (below 1 eV) is sufficiently higher than 2.0 to enable breeding also in thermal reactors. Thus, self-sustainable Th-U fuel cycles can operate at any neutron spectrum, while the U-Pu fuel cycle unavoidably requires a fast neutron spectrum.

In a thermal spectrum, Th-232 has higher neutron capture cross section than U-238 by about a factor of three, which also makes the fertile to fissile material conversion more efficient. It has the additional advantage of reducing the excess reactivity in an initial core, which reduces the amount of needed control material to suppress this initial reactivity.

These unique features of Th – U-233 fuel combine to allow the proven light water reactor technology to be used for achieving self-sustainable reactor operation thus avoiding the development of more complex fast reactors with large cost uncertainty.

It is also worth noting that even in fast breeder reactors, the thorium fuel cycle may offer some advantages with respect to flexibility of the core design. One of the safety-related concerns common to all fast spectrum reactors is the positive reactivity feedback due to the coolant thermal expansion. The use of Th fuel reduces the magnitude of this effect (or may even eliminate it) because of the smaller increase in the number of neutrons released per absorption in U-233 as the spectrum hardens as compared with other fissile nuclides, and also due to the smaller fast fissions effect of Th-232 compared to U-238.

Considerable research has been conducted in the past to investigate feasibility of thorium cycle [IAEA, 2005, Todosow et al., 2005, Kim and Downar, 2002]. Thorium fuel has been irradiated and examined in a variety of reactors, including the US and German gas-cooled reactors featuring coated particle fuel, in addition to boiling and pressurized water reactors at Elk River and Indian Point in the US. These studies showed very good performance of Th fuel as a material [Belle and Berman, 1984], in both oxide form in LWRs as well as in carbide form in gas-cooled reactors. Economics favored the uranium fuel cycle and the work was discontinued.

Most notably however, the feasibility of a closed Th – U-233 fuel cycle has been demonstrated by the Light Water Breeder Reactor (LWBR) program in a pressurized water reactor at Shippingport, Pa. The results of this program confirmed experimentally that net breeding of U-233 (with a fissile conversion ratio of just over one) can be achieved using a heterogeneous uranium-thorium core in a thermal spectrum light water reactor [Atherton, 1987].

In the near future perspective, a number of difficulties will have to be overcome in order for the Th-U fuel cycle to be implemented in the current or advanced reactors.

**PROLIFERATION AND SECURITY GROUND RULES.** Irradiating thorium produces weapons-usable material. Policy decisions on appropriate ground rules are required before devoting significant resources toward such fuel cycles. U-233 can be treated two ways.

- Analogous to U-235. If the U-235 content of uranium is less than 20% U-235 or less than 13% U-233 with the remainder being U-238, the uranium mixture is non-weapons material. However, isotopic dilution in U-238 can significantly compromise many of the benefits.



- Analogous to plutonium. Plutonium can not be degraded thus enhanced safeguards are used. The same strategy can be used with U-233. A complicating factor (see below) is that U-233 is always contaminated with U-232 that has decay products that give off high energy gamma radiation which requires additional measures to protect worker health and safety. There has been no consensus on the safeguards/nonproliferation benefits of this radiation field.

**FUEL PROCESSING TECHNOLOGY.** Spent fuel reprocessing technology must be available in order to recycle the generated U-233. This requirement is also true for traditional U-Pu self sustainable fuel cycles in fast reactors. Although ThO<sub>2</sub> reprocessing has been successfully demonstrated in the past, it is more complex than reprocessing of U-Pu mixed oxide (MOX) fuel [Lung, 1997]. This is due to the fact that ThO<sub>2</sub> is more chemically stable and therefore requires the use of corrosive chemicals and larger volumes of solvents involved in the extraction process.

**FUEL FABRICATION.** A second difficulty is the requirement of using hot-cells, in contrast to glove boxes as in the case of U-Pu MOX, for fuel fabrication that can significantly escalate the cost of fabrication. A small amount of U-232 inevitably accumulates in any Th containing fuel during irradiation, which would be carried over together with the reprocessed U-233. The radioactive decay chain of U-232 contains nuclides that emit very high energy gamma rays that are difficult to shield. These strong gamma emitters build up to significant concentrations within just several months following the fuel discharge and do not decay until after about 130 years, making both very fast reprocessing and extended cooling time impractical approaches to mitigating this problem. On the other hand, it has also been argued that the high dose rate from separated U-233 due to U-232 daughters decay provides sufficient self protection and detectability to consider the closed Th-U-233 fuel cycle more proliferation resistant than the U-Pu cycle, in which Pu can potentially be diverted without detection more easily.

Fabrication might also be more complex due to the very high melting point of ThO<sub>2</sub> (3350°C) as compared with UO<sub>2</sub>. This implies that higher sintering temperature or special sintering agents will be required in order to fabricate high density ThO<sub>2</sub> fuel pellets.

**LWR CORE DESIGN.** An LWR core design for a self sustainable Th cycle would be more complex and likely to have lower power density than conventional UO<sub>2</sub> core operating in once through fuel cycle. The number of fission neutrons released per absorption in U-233 is only marginally sufficient for break-even breeding and sustaining the core criticality. Therefore, reactivity control of the core must be engineered carefully to minimize parasitic absorption and leakage of neutrons. Additionally, spatial separation of fissile and fertile regions within the core is required in order to maximize the conversion ratio. This would result in some power imbalance between the fissile and fertile-rich regions, which would limit the achievable overall power density.

## PLUTONIUM RECYCLING

In recent years, proliferation concerns over the growing stockpile of civilian as well as military Plutonium prompted a number of studies to explore the possibility of Pu burning in existing LWRs. Utilization of mixed oxide U-Pu (MOX) fuel offers the most readily available alternative because of the existing experience with the use of MOX in LWRs. However, the rate of Pu destruction and the net fraction of Pu that can be destroyed per pass through

the core are limited for the MOX fuel because neutron captures in U-238 generate new Pu as the originally loaded Pu is burnt by fission.

Thorium, on the other hand, would not generate any new Pu if used as a matrix for Pu disposition. The use of Th fuel matrix instead of natural or depleted uranium would roughly triple the rate of Pu destruction and improve the fractional Pu burnup from about 20% for the conventional MOX case to over 60% for the Th MOX case [Shwageraus et al.,2004]. Even deeper burndown is possible if Weapons Grade (WG) Pu is used as fissile driver instead of Reactor Grade (RG) Pu. However, using thorium as the exclusive inert material creates a proliferation issue since the resulting uranium would be weapons-useable and recoverable by chemical separation.

Isotopic composition of the Pu vector changes dramatically with irradiation in both Uranium and Thorium based MOX fuels because the fissile isotopes are preferentially depleted in the thermal LWR spectrum leaving mostly “even” Pu isotopes in the spent fuel. Such an isotopic mix is generally considered more proliferation resistant.

Production of minor actinides in the Pu-Th MOX fuel will also be less than in Pu-U MOX, reducing the long-term environmental impact of the spent fuel in the repository [Gruppelaar and Schapira, 2000].

Results of several independent studies showed that LWR core physics of mixed oxide PuO<sub>2</sub>-ThO<sub>2</sub> fuel is very similar to the conventional PuO<sub>2</sub>-UO<sub>2</sub> MOX fuel leading to the conclusion that Th MOX fuel can be used in the existing LWRs with minimal impact on the core design and operation [IAEA, 2003].

Although all of the studies so far focused on once-through Pu burndown, multiple Pu recycling may be feasible with ThO<sub>2</sub> matrix in LWRs because of the more favorable void coefficient of reactivity.

Thorium that is used as a ThO<sub>2</sub> matrix has very favorable thermo-physical properties such as higher than UO<sub>2</sub> thermal conductivity and lower coefficient of thermal expansion. It has also been shown that ThO<sub>2</sub> has higher radiation stability and retention of fission gases when irradiated to the same burnup at the same temperature [Belle and Berman, 1984].

The once-through Pu disposition scenario assumes direct disposal of the spent MOX fuel in a geological repository. In this case, the high chemical stability of ThO<sub>2</sub> becomes beneficial. Thorium has only one oxidation state unlike Uranium which oxidizes from UO<sub>2</sub> to U<sub>3</sub>O<sub>8</sub> and thus tends to be more mobile in the repository environment such as Yucca Mountain. Smaller amounts of long lived minor actinides also help to reduce the long term radiotoxicity of the spent fuel. However, decay of Th transmutation chain nuclides such as Pa-231 and U-233 make the spent Th MOX fuel in-situ radiotoxicity even higher than that of the conventional MOX for the time period between about 10<sup>4</sup> and 10<sup>6</sup> years [Gruppelaar and Schapira, 2000, IAEA, 2003].

Although initially loaded Pu is effectively destroyed using the Th MOX, the presence of U-233 in the spent fuel, by itself, raises proliferation concerns because, theoretically, it can be chemically separated and used in weapons. As mentioned earlier, one approach would be to argue that trace quantities of U-232 will be carried together with U-233 and therefore provide sufficient barrier against diversion of fissile material due to the high radiation dose rate.

In case self-protection of U-232 daughters by high radiation doses is found inadequate by itself, it has also been suggested that dilution (denaturing) of U-233 by a pre-existing small amount (10 to 15%) of natural uranium added to the fuel mixture prior to the irradiation will be needed. Such denaturing significantly reduces the effectiveness of Pu destruction, as it enables generation of new Pu from the added U, although it still remains preferable to the conventional MOX fuel.

## **REDUCTION OF PU CONTENT IN SPENT FUEL**

Thorium can, if used as part of the nuclear fuel, reduce the Pu accumulation rate in the total fuel cycle, and in particular in the spent fuel of the LWR fleet operating in a once-through mode of the fuel cycle. This is accomplished by substituting most of the U-238 as fertile fuel component with Th, which does not generate Pu. Medium enriched uranium is still needed as a fissile driver for the Th. Studies performed on this subject identified a number of challenges with implementation of this approach.

Uranium-238 cannot be replaced completely with thorium because, in that case, the fissile uranium enrichment needed as driver will have to be 100 percent. Non-proliferation guidelines limit the maximum uranium enrichment to under 20 percent. For example, if the reactor core contains 5% U-235, the fuel will contain at least 20% U-238 in addition to 75% Th-232. The fact that U-238 cannot be eliminated from the fuel implies that generation of some Pu would be impossible to avoid entirely.

As stated earlier, U-233 is a superior fissile material to Pu-239 in a thermal neutron spectrum. Therefore, in addition to reducing Pu generation rate, Th-U fuel may also provide some uranium savings due to better conversion of Th into U-233. However, taking advantage of the U-233 superior fissile properties has to be realized in-situ, i.e. without separating it from the spent fuel. Furthermore, U-233 tends to build up more slowly than Pu-239 during irradiation. Therefore, long irradiation time would be required to benefit in-situ from the bred U-233. Thus, high burnup fuel would have to be designed, including corrosion resistant clad that might stay in the core for 10 or more years.

A number of approaches have been suggested to implement the once through thorium – enriched uranium fuel cycle in LWRs. The simplest approach, which would require practically no changes in the core design, is to use homogeneously mixed thorium – enriched uranium fuel in about 3:1 proportion. This approach results in a moderate reduction in the Pu production rate by roughly a factor of two. It also makes the Pu isotopic vector slightly less suitable for weapons use. However, the fuel burnup that can be achieved per unit mass of natural uranium required to manufacture the fuel and also per unit of separative work (SWU) required for the uranium enrichment is much lower in the case of homogeneously mixed U-Th fuel. This decrease in the natural uranium and SWU utilization leads to considerably higher fuel cycle cost, questioning the merit of this approach given only modest improvement in proliferation resistance characteristics [Galperin et al., 2002, Shwageraus et al., 2005].

The main reason for the inferior characteristics of a homogeneous U-Th fuel cycle is the fact that the subcritical Th fuel component requires relatively long irradiation time (initial neutron investment) in order to realize the benefits of the superior fissile properties of U-233. The natural uranium utilization which is at break even with the conventional UO<sub>2</sub> fuel

could be achieved at about 100 MWd/kg burnup for the U-Th fuel cycle, which is beyond the current LWR fuel experience. It would also require the uranium fraction of the fuel to be about 50% (1:1 proportion of U and Th) correspondingly increasing the Pu production rate and diminishing the proliferation resistance advantage of the fuel.

An alternative approach to minimize the Pu production in a once through fuel cycle that could avoid limitations of the homogeneous fuel concept is to allow separate fuel management for the uranium and thorium parts of the fuel. In such a heterogeneous core, the Th-rich fuel would stay long enough and generate energy (from bred U-233) required to compensate for the initial neutron investment, while enriched uranium part would be changed more frequently. Furthermore, fuel pins lattice in the uranium and thorium regions could be optimized separately to maximize breeding and in-situ burning of U-233.

Two heterogeneous core design options were proposed and investigated recently, and are known as Radkowsky Seed-Blanket Unit (SBU) [Galperin et al., 1997] and Whole Assembly Seed-Blanket (WASB) [Wang et al., 2003]. In the former design, the Th blanket and fissile seed zones are confined within a single 17×17 typical PWR fuel assembly, whereas, in the latter case, each of the seed and blanket fuel pin types occupy the entire 17×17 fuel assembly. The fuel pins arrangements in SBU and WASB assemblies are shown in Figure A.3. While the original design of the SBU relied on metallic fuel for the seed, as does the fuel offered by Thorium Power (now Lightbridge), the MIT suggested design uses UO<sub>2</sub> pellets, with central holes to avoid reaching high temperatures.

In both designs, the blanket fuel stays in the core for multiple irradiation cycles (10 years or longer), while the fissile seed fuel is refueled as a conventional 3-batch core approach, every 12 to 18 months. These heterogeneous core design options have similar performance, reducing the Pu production rate by a factor of 3 to 4 while operating at fuel cycle cost and natural uranium utilization comparable to the conventional UO<sub>2</sub> fuel LWRs. In the SBU fuel approach, the mechanical fastening of the inner seed sub-assembly within the larger assembly may add a complication not present in the WASB. In addition, spent fuel volume and therefore storage requirements can be reduced by up to 40% by employing Seed-Blanket core designs. The long term radiotoxicity is similar to UO<sub>2</sub> fuel with some penalty after 10<sup>4</sup> years due to decay of U-233 daughters as typically observed for the Th-containing fuels. Nevertheless, this higher radiotoxicity may be compensated by the fact that ThO<sub>2</sub> is more chemically stable than UO<sub>2</sub> and thus provides better retention of radioactive nuclides.

It was also shown that the heterogenous concept can be applied for burning excess Plutonium providing some additional benefits such as higher control rods reactivity worth which is typically a problem for Pu-Th as well as for U-Pu MOX fuel while maintaining the same Pu burning efficiency [Galperin et al., 2000].

The major concerns with the heterogenous approach that could challenge its implementation are related to high burnup (above 100 MWd/kg) of the seed fuel and long in-core residence time of the blanket fuel. Therefore, development and use of advanced cladding materials for both fuel pin types and large plenum to accumulate fission gases for the seed pins will be required to alleviate these problems.

**Figure A.3 Schematic view of SBU and WASB fuel assemblies**

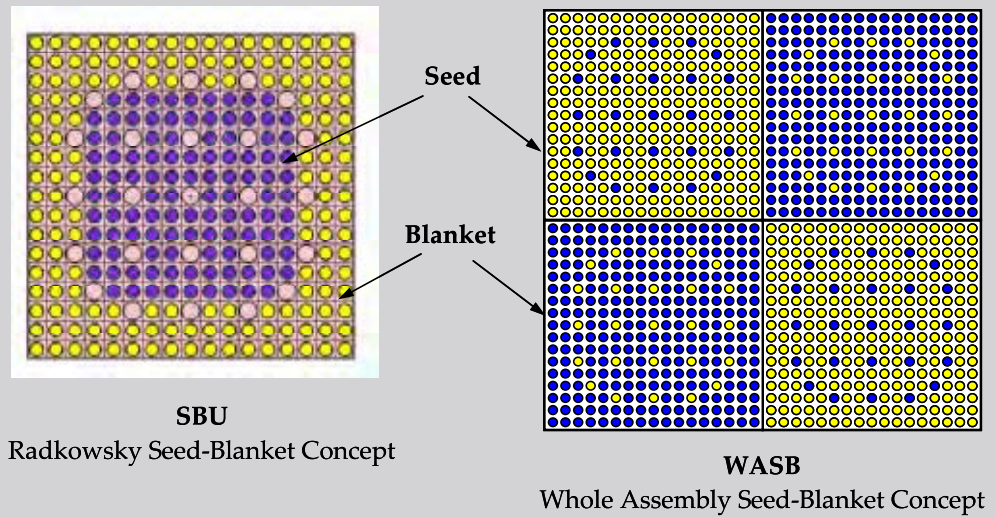

### SUMMARY

Use of thorium can enhance the nuclear fuel availability by employing self sustainable Th-U233 fuel cycle. This can be accomplished using existing LWR technology but would require spent fuel reprocessing and remote fuel fabrication capabilities.

Thorium can also be used to improve proliferation resistance of the fuel cycle by burning excess plutonium as Th-Pu MOX fuel and by reducing the quantity and quality of Pu in the once through cycle spent fuel. These strategies can be applied universally to the entire fleet of existing LWRs although PWRs were studied in somewhat more details. Various options of using thorium fuel with different levels of design complexity were studied for the purpose of improving proliferation resistance. Generally, the extent of Pu generation rate reduction is traded off with the design complexity and availability of advanced cladding materials.

Chemical and irradiation stability of ThO<sub>2</sub> represent significant advantage with respect to fuel behavior in the core and in the repository. The same characteristics however complicate fuel reprocessing and thus escalate the costs associated with U-233 recycling.

Similar two-way reasoning can also be applied to the high radiation dose rate from separated U-233 due to decay of U-232, which inevitably accumulates in small quantities in Th containing fuels. On one hand, high radiation dose provides self protection to separated fissile material against diversion and misuse. On the other hand, it makes the U-233 recycling more complex and costly.

Overall, recent research and past experience indicate that there are no technological show-stoppers that could prevent the use of Th fuel and fuel cycle in the existing and evolutionary Light Water Reactors for achieving either sustainability or proliferation resistance goals. However, the technology of thorium fuel does not offer sufficient incentives from a cost or waste point of view to easily penetrate the market. Only if reduction of Pu content of the fuel cycle, and acceptability of U-233 instead, are favored by the proliferation evaluation community would there be a reason to move in the near future to apply the thorium cycle.

## CITATIONS AND NOTES

- Atherton R. (Coordinator), "Water cooled breeder program summary report (Light Water Breeder Reactor development program)," WAPD-TM-1600, Bettis Atomic Power Lab, (1987).
- Belle J. and Berman R.M., Ed., *Thorium Dioxide: Properties and Nuclear Applications*, US DOE/NE-0060, (1984).
- Galperin A., Segev M., Todosow M., "Pressurized water reactor plutonium incinerator based on thorium fuel and seed-blanket assembly geometry", *Nuclear Technology*, **132**, 214-226, (2000).
- Galperin A., Shwageraus E., Todosow M., "Assessment of Homogeneous Thorium/Uranium Fuel for Pressurized Water Reactors", *Nuclear Technology*, **138**, 111-122, (2002).
- Galperin, A., Reichert, P., Radkowsky, A., "Thorium Fuel for Light Water Reactors-Reducing Proliferation Potential of Nuclear Power Fuel Cycle," *Science & Global Security*, **6**, 3, 265-290 (1997).
- Gruppelaar H., Schapira J.P. (Editors), *Thorium as a Waste Management Option*, Final Report EUR 19142EN, European Commission, (2000).
- International Atomic Energy Agency, "Potential of Thorium-based Fuel Cycles to Constrain Plutonium and to Reduce the Long-lived Waste Toxicity," IAEA-TECDOC-1349, (2003).
- International Atomic Energy Agency, "Thorium Fuel Cycle – Potential Benefits and Challenges," IAEA-TECDOC-1450, Vienna (2005).
- M. S. Kazimi, "Thorium Fuel for Nuclear Energy" American Scientist (2003).
- Kim T.K., and Downar T., "Thorium Fuel Performance in a Tight-Pitch Light Water Reactor Lattice", *Nuclear Technology*. **138**, 17-29, (2002).
- Lidsky, L.M., "Fission-fusion systems - Hybrid, symbiotic and Aagean," *Nuclear Fusion*, **15**, 151-173, (1975).
- Lung M., "A Present Review of the Thorium Nuclear Fuel Cycles", European Commission, Nuclear Science and Technology Series, EUR 17771, (1997).
- Rubbia C., Rubio J. A., Buono S., Carminati F., Fiétier N., Galvez J., Gelés C., Kadi Y., Klapisch R., Mandrillon P., Revol J. P., and Roche Ch., "Conceptual Design of a fast Neutron Operated High Power Energy Amplifier," CERN-AT-95-44(ET), Geneva, (1995).
- Shwageraus E., Hejzlar P., Kazimi M. S., "Use of Thorium for Transmutation of Plutonium and Minor Actinides in PWRs", *Nuclear Technology*, **147**, 53-68, 2004.
- Shwageraus E., Zhao X., Driscoll M. J., Hejzlar P, Kazimi M. S., Herring J. S., "Micro-heterogeneous Thoria-Urania Fuels for Pressurized Water Reactors", *Nuclear Technology*, **147**, 20-36, (2005).
- Todosow M., Galperin A., Herring S., Kazimi M., Downar T., Morozov A., "Use of Thorium in Light Water Reactors", *Nuclear Technology*, **151**, 168-176, (2005).
- Wang D., Kazimi M.S., and Driscoll M.J., Optimization of a Heterogeneous Thorium-Uranium Core Design for Pressurized Water Reactors, MIT-NFC-TR-057, (July 2003).



## Appendix B — Advanced Technologies

The focus of this report is primarily on traditional reactor and fuel cycle concepts. However, there are several alternative technologies that, if successfully developed and economically deployed, would result in major changes in the fuel cycle and the future of nuclear power. Each of these alternative technologies has to overcome technical or economic uncertainties. They were not considered credible alternatives when nuclear fuel cycles were evaluated in the 1970s because (1) the technology was not sufficiently developed or (2) the technology was not considered viable given the assumptions of limited uranium resources and the priority for development of reactors with the highest possible fuel conversion ratio. They should now be considered when examining the future nuclear power or fuel cycle options.

We do not claim this is a complete list of options (Table B.1). Nor do we claim that the traditionally favored future fuel cycle (based on sodium-cooled fast reactors with fuel recycling) is the wrong future option—it may be the right option. Instead it is our judgment that there have been so many changes in technology and the criteria to judge fuel cycles that it is advisable to reexamine the options before major decisions on fuel cycles are made. For each of these technologies, there is herein a short description of the concept (in italics) which summarizes its significance, weaknesses, and strengths that is followed by a more detailed technical description.

**Table B.1 Advanced Technologies**

TECHNOLOGY	POTENTIAL ADVANTAGES	TECHNICAL CHALLENGE
<i>Reactors</i>		
High-conversion LWR	Economics, experience base, fuel management flexibility	Fuel performance, accident analysis
Once-through sustainable sodium-cooled fast reactor	Nonproliferation, no fuel reprocessing.	Cladding radiation limits
Lead-cooled fast reactor	Economic fast reactor, enhanced safety	Materials corrosion by lead, high freezing temperature
Advanced High Temperature Reactor	Economics, multiple fuel cycles, thorium fuel cycle	Limited analysis, fuel power density limits
<i>Fuel Cycles</i>		
Uranium from Seawater	Uranium for millennia	Absorber lifetimes
Low-enriched uranium startup of fast reactors	Nonproliferation, economics, sustainability	Limited analysis, possible cladding burnup limits
Borehole disposal of long-lived radioactive waste	Repository acceptance, nonproliferation	Limited analysis, no testing
Co-location of fabrication, reprocessing, and repository facilities	Repository acceptance, economics, risk, safeguards	Limited analysis
Nuclear Renewable symbiosis	Enable renewables and liquid fuels production	Coupling nuclear to other application technologies



## REACTOR TECHNOLOGIES

Nuclear power economics are primarily determined by the capital cost of the nuclear reactor; thus, reactor choices often drive fuel cycle choices. In the last decade there have been studies and laboratory developments suggesting, but not demonstrating, potentially economic alternative reactor concepts that, if developed, would have a major impact on fuel cycle choices. In each case there are one or more technical issues that have not been fully resolved but where a relatively limited focused effort over a few years could determine concept viability.

### High-Conversion LWR

*Abstract—The historical choice of the fast reactor to enable full utilization of the energy content of uranium and burning actinides is the sodium-cooled fast reactor (SFR). SFRs were chosen because of their high conversion (breeding) ratio (1.2 to 1.3) that enables them to produce fuel faster than it is consumed. They have not been deployed because of their higher capital cost compared to LWRs. Our fuel cycle dynamic modeling indicates that a conversion ratio near unity may be preferred. LWRs with modified reactor cores can have conversion ratios near unity (but not 1.2) and thus could be a viable alternative to SFRs. Sustainable high-conversion LWRs [1] with conversion ratios near unity have several potential advantages as an alternative to SFRs: (1) use of the existing reactor system technology except for the reactor core, (2) expected capital and operating costs [except fuel cycle] similar to existing LWRs, and (3) operations similar to existing LWRs. Commercialization would require development of the reactor core but not of the entire nuclear reactor system. The concept of a sustainable high-conversion LWR is a result of many developments and new ideas over a period of decades.*

Because today LWRs have lower capital costs than SFRs and high reliability (a consequence of operating experience), a sustainable high-conversion LWR operating with a closed fuel cycle may be more economic and have a lower development cost than an SFR. The development of the reactor core technology may provide the option of using some of the existing reactor fleet for a closed, sustainable fuel cycle. The analysis, experiments, and demonstrations to determine the technical, safety, and economic viability of a high-conversion LWRs have not been done.

### Thorium Fuel Cycle Options

An LWR can have a conversion ratio near unity using a thorium fuel cycle. This was demonstrated in the light-water breeder reactor program between 1977 and 1982 at the Shippingport Nuclear Power Station [2]. Because thorium is a fertile material, not a fissile fuel, such reactors must be started up on enriched uranium or plutonium. The Shippingport experiment used high-enrichment uranium and U-233, an option that would not be considered viable today for nonproliferation reasons. New thorium fuel cycle options using low-enrichment uranium are discussed in Appendix A on thorium fuel cycles.

### Uranium Fuel Cycle Options

In a reactor using U-235 as the fertile isotope, the dominant factor in determining the conversion ratio is its neutron energy spectrum. A fast spectrum (high neutron kinetic energies) will yield a high conversion ratio. The average neutron kinetic energy in a reactor increases as the moderator-to-fuel ratio decreases. This is because moderators (named

because of their effects on the neutron energy), such as water, slow down the fast neutrons resulting from fission. Thus, fast reactor designs that use non-moderating coolants such as liquid metallic sodium are able to obtain fast spectra and achieve high conversion ratios (up to 1.3) for uranium-based fuel. In contrast, current LWRs have thermal spectra (low average neutron energies) which result in conversion ratios between 0.5 and 0.6.

Water-cooled reactors can produce conversion ratios near unity if an epithermal (between thermal and fast) spectrum is achieved. This can be done by reducing the moderator-to-fuel ratio and/or using heavy water ( $D_2O$ ) as a coolant since it is a less efficient moderator.

Neutrons do not lose as much energy per collision when scattering off of heavy water ( $D_2O$ ) compared to light water ( $H_2O$ ) since the deuterium nuclei in heavy water molecules are twice as massive as the hydrogen nuclei in light water. Therefore, the neutron spectrum is harder (faster) when  $H_2O$  is replaced with  $D_2O$  in a water-cooled reactor with a low moderator-to-fuel ratio. This is one way to obtain a higher conversion ratio. However, the use of heavy water comes with some disadvantages: (1) heavy water costs several hundred dollars per kilogram, (2) the reactor system must be designed to minimize losses of the expensive coolant and avoid contamination with  $H_2O$ , and (3) neutron capture by deuterium produces tritium, a radioactive isotope of hydrogen that must be efficiently collected through recovery systems.

Because most of the world's reactors are pressurized water reactors (PWRs), a type of LWR, most of the early work on sustainable LWRs was associated with PWRs. A high-conversion PWR using the plutonium-uranium fuel cycle was first suggested by Edlund [3] in 1976. The concept was to harden the spectrum by reducing the water-to-fuel volume by redesigning the core of a Babcock & Wilcox PWR into one with a hexagonal pin lattice and hexagonal assemblies. This resulted in a conversion ratio of about 0.9 while maintaining sufficient cooling and a small negative void reactivity coefficient.

The concept of retrofitting an existing PWR using a hexagonal lattice for a high-conversion ratio was proposed by Broeders in 1985 for a Kraftwerk Union 1300 MWe PWR [4]. This design also introduced heterogeneous seed and blanket reactor core designs that had two major beneficial impacts; (1) it increased the conversion ratio to 0.96 and (2) it resulted in a large negative void coefficient [better nuclear safety upon overpower occurrence]. When the water temperature increases, the resultant decrease in its density yields a harder spectrum resulting in more fast neutrons leaking from the fissile regions into the fertile regions resulting in more neutron absorption and lower power levels. Seed and blanket designs became a fixture of all future sustainable LWRs. Seed and blanket concepts imply the seed operates at a high power output and the blanket operates at a low power output—characteristics that tend to reduce thermal margins and increase pumping power requirements. The safety constraint is cooling the higher powered seed under loss of coolant accident conditions.

Ronen [5] proposed a 1000MWe PWR with a conversion ratio of 0.9, which featured axially heterogeneous rods with alternating layers of fissile plutonium (MOX) fuel and fertile (natural  $UO_2$ ) regions. This was followed by the high-gain PWR proposed by Radkowsky [6], which features two seed-blanket cores: a prebreeder and breeder. The concept used rapid fuel reprocessing to minimize the loss of  $^{241}Pu$  through beta decay (14.4 year half life).  $^{241}Pu$  has the highest  $\eta$  (number of neutrons emitted per capture of a neutron) of all uranium and plutonium isotopes and can greatly increase the conversion ratio. The prebreeder core uses a soft spectrum to produce the  $^{241}Pu$  through sequential thermal neutron capture

via  $^{239}\text{Pu}$  and  $^{240}\text{Pu}$ , and then the fuel is quickly reprocessed and moved to the fast spectrum breeder core where the  $^{241}\text{Pu}$  is fissioned. An overall conversion ratio of 1.08 and a strong negative void reactivity can be achieved if very rapid (3 months) reprocessing technologies can be developed.

Hittner [7] investigated a convertible spectral shift reactor that is a high conversion reactor using spectral-shift to optimize breeding. The water-to-fuel volume ratio is adjusted by filling water holes in the assemblies with depleted uranium. The uranium rods are inserted in the beginning of the cycle to hold down excess reactivity and breed Pu. They are withdrawn progressively by mechanical systems with burnup. A conversion ratio of 0.95 is achievable.

The most recent work on sustainable PWRs was conducted in Japan [8, 9]. The designs use hexagonal seed-blanket assemblies where fissile pins are placed in the center of the assembly with fertile pins on the periphery. Moderating  $\text{ZrH}_{1.7}$  pins are used in the blanket regions [8] to make the void coefficient more negative by softening the spectrum. Both conceptual designs feature a tight hexagonal pitch and a conversion ratio of 1.0. The Japanese work on high-conversion light water reactors has moved from PWRs to sustainable boiling water reactor (BWR) designs because (1) Japan has more BWRs than PWRs and (2) advances in understanding boiling in these reactors have created new design options. Work elsewhere continues on high-conversion PWRs. The history over several decades has been of continuing progress in development of viable high-conversion PWR reactor cores.

Boiling water breeders can afford to have higher pitch-to-diameter ratios relative to pressurized water breeders since the water density can be decreased by increasing the steam void fraction. The most recent work on light water breeders has been done by Hitachi [10] and JAEA [11, 12] on the RBWR (Resource-renewable Boiling Water Reactor) and FLWR (Innovative Water Reactor for Flexible fuel cycle), respectively. Both designs are retrofits for existing 3926-MWt Advanced Boiling Water Reactors where only the core is redesigned. Both have conversion ratios greater than 1.0 and a negative void coefficient by using axially heterogeneous fuel (alternating fissile/fertile zones), tight hexagonal pitch and hexagonal assemblies, and core average void fractions of  $\sim 0.60$ , higher than the typical ABWR void fraction of  $\sim 0.4$ .

One of the differences between the two designs (aside from pin dimensions, number of pins per assembly, and other geometric differences) is that the FLWR employs a 2-stage core concept where the conversion ratio can be varied from 1 to somewhat greater than one. Both cores have the same geometry so the first stage can proceed to the second in the same reactor system, providing flexibility during the reactor operation period for future fuel cycle circumstances. Both designs are still in the research and development stage but represent the state-of-the-art designs for high-conversion LWRs [13]. The Japanese development of the high-conversion LWR, coupled with bringing into commercial operation the new Rokkasho reprocessing facility, may provide a contingency option for rapid conversion to a closed sustainable fuel cycle, if desired.

Redesigning current light water reactor cores with lower water-to-fuel volume ratio and heterogeneous seed-blanket arrangements may be the simplest and quickest option for a sustainable reactor. However, more research and development is required for this technology, especially for application to PWRs, the most common type of LWR. The question is how to best achieve a conversion ratio of unity while providing sufficient cooling margins under accident conditions.

## CITATIONS AND NOTES

1. Ronen, Y., *High Converting Water Reactors*, CRC Press, Boca Raton, FL, 1990.
2. Connors, D.R. et al., *Design of the Shippingport Light Water Breeder Reactor*, WAPD-TM-1208, Bettis Atomic Power Lab, West Mifflin, PA, 1979.
3. Edlund, M.C., "Physics of Uranium-Plutonium Fuel Cycles in Pressurized Water Reactors," *Transactions of the American Nuclear Society*, 24, 508, 1976.
4. Broeders, C.H.M., "Conceptual design of a (Pu, U)O<sub>2</sub> core with a tight fuel rod lattice for an advanced pressurized light water reactor," *Nuclear Technology*, 71, 82–95, 1985.
5. Ronen, Y. and Y. Dali, "A High-Conversion Water Reactor Design," *Nuclear Science and Engineering*, 130, 239-253, 1998.
6. Radkowsky, A. and Z. Shayer, "The High Gain Light Water Breeder Reactor with a Uranium-Plutonium Cycle," *Nuclear Technology*, 80, 190-215, 1988.
7. Hittner, D., J.P. Millot, and A. Vallee., "Preliminary Results of the Feasibility on the Convertible Spectral Shift Reactor Concept," *Nuclear Technology*, 80, 181, 1988.
8. Hibi, K., et al., "Conceptual designing of reduced-moderation water reactors (2)—design for PWR-type reactors," *Proceedings of the 8th International Conference on Nuclear Energy*, Paper 8423, April 2-6, 2000.
9. Shelley, A. et al., "Optimization of seed-blanket type fuel assembly for reduced-moderation water reactor," *Nuclear Engineering and Design*, 224, 265-278, 2003.
10. Takeda, R., et al., "General Features of Resource-Renewable BWR (RBWR) and Scenario of Long-term Energy Supply," *Proceedings of the International Conference on Evaluation of Emerging Nuclear Fuel Cycle Systems*, GLOBAL '95, 1, 938, 1995.
11. Iwamura, T., et al., "Concept of Innovative Water Reactor for Flexible Fuel Cycle (FLWR)," *Nuclear Engineering and Design*, 236, 1599-1605, 2006.
12. Uchikawa, S., T. Okubo, and Y. Nakano, "Breeder-type Operation based on the LWR-MOX Fuel Technologies in Light Water Reactors with Hard Neutron Spectrum (FLWR)," *Proceedings of ICAPP 2009, Tokyo, Japan*, Paper 9022, May 10-14, 2009.
13. International Atomic Energy Agency, *Status of Advanced Light Water Reactor Designs 2004*, IAEA-TECDOC-1391, 2004.

## Once-Through Sustainable Fast Reactor

*Abstract—It has been traditionally assumed that a closed fuel cycle with reprocessing and recycling of fuel is required for sustainable nuclear energy. However, there have been proposals for decades to develop sustainable fast reactors with once-through fuel cycles that have startup reactor cores of enriched uranium and are refueled with natural or depleted uranium. The SNF becomes a waste but uranium utilization is an order of magnitude greater than in today's LWRs. In each fuel assembly uranium-238 is converted to plutonium and that plutonium is then fissioned in situ to produce energy. This reactor has several potential advantages. The fuel cycle costs would be low. Such reactors would eliminate the need for uranium enrichment plants except for one such plant worldwide for startup reactor cores—thus most proliferation concerns associated with front-end fuel cycle facilities would be minimized. Last, a country could (1) buy a reactor and the first reactor core and (2) fabricate depleted or natural uranium replacement fuel at low cost and not need enriched uranium after initial startup. Alternatively a lifetime supply of the low-cost depleted or natural uranium fuel assemblies could be purchased and be part of the initial reactor core. There would be no incentive for countries to build enrichment plants to assure fuel supplies for existing reactors.*

*The technical limitation is that the fuel and fuel cladding must withstand very high burnup. Recent advances in computational design methods by TerraPower have enabled design of once-through fast reactor cores with lower (but still very high) fuel burnups relative to earlier designs of such reactors. It is not known if existing fuel cladding materials can go to these high*

*burnups, but the gap between the necessary fuel burnup for a technically viable reactor and the experience base has narrowed. The TerraPower reactor is a modified sodium fast reactor but the concept would be applicable to lead-cooled fast reactors (see below). Beyond technical feasibility is the separate question of economic viability of the fast reactor.*

The concept of a once-through sustainable reactor with in-situ breeding is not new. The concept of a reactor that could breed its own fuel inside the reactor core was initially proposed and studied in 1958 by Saveli Feinberg [1]. This concept is often referred to as the breed and burn reactor concept. Driscoll et al. published further research on the concept in 1979 [2], as did Lev Feoktistov in 1988 [3], Edward Teller/Lowell Wood in 1995 [4], Hugo van Dam in 2000 [5], Hiroshi Sekimoto in 2001 [6] and Yarsky et al. in 2005 [7]. Previous studies have shown that the primary technical challenge is fuel cladding that must survive very high neutron fluences and fuel burnups to achieve a steady-state breed-and-burn condition. Recently, TerraPower, LLC has developed methods to achieve steady-state breed-and-burn cores that significantly reduce the neutron fluence and burnup, and consequent core materials degradation. Their proposed traveling wave reactor (TWR) with lower materials requirements was achieved by a combination of core design features and engineering accommodations that would need to be demonstrated in a prototype TWR.

Various concepts are under exploration from a small modular design rated at hundreds of MW(e), to a large monolithic power plant for baseload electrical power production of a gigawatt or more to address the potential range of applications. The first versions of TWRs are based on elements of sodium-cooled fast-reactor technology [8-10]. The core design that emerged as most promising has an approximate cylindrical core geometry composed of hexagonally shaped fuel bundles (assemblies) containing a combination of enriched and depleted uranium metal alloy fuel pins clad with a sodium thermal bond in ferritic-martensitic steel tubes. Depending on power density, after a predetermined time (e.g., one to two or more years) of core operation, the reactor is shut down in order to move high-burnup assemblies to low-power regions of the core, replacing them with depleted uranium assemblies. This fuel shuffling accomplishes three functions: (1) controls the power distribution and burnup so that core materials remain within operating limits, (2) manages excess reactivity, in conjunction with control rods and (3) extends the life of the reactor core because core life is largely determined by the number of depleted uranium assemblies available for shuffling.

All the fuel movements are accomplished in a sealed reactor vessel, which contains enough depleted uranium assemblies to support reactor operation for the plant lifetime. After the initial small number of enriched fuel assemblies initiate reactor operation, enough fissile material in depleted uranium assemblies will have been bred so that the core continues to run on depleted uranium until the end of plant life. The feed material (except for the startup enriched uranium fuel assemblies) can be depleted uranium (over a million tons in world inventory), natural uranium, or LWR SNF after conversion to a metallic form (without separation of radionuclides). The fuel cycle costs would be expected to be lower than for any other reactor.

The technical issue is whether the fuel can obtain a high burnup required to breed enough fuel to maintain reactor operation. The experimental data base on fuel cladding fluence limits does not go to the required burnup; thus, it is not known whether existing materials could meet these requirements or new materials would be required.

## CITATIONS AND NOTES

1. S. M. Feinberg, "Discussion Comment," *Rec. of Proc. Session B-10*, ICP UAE, United Nations, Geneva, Switzerland, 1958.
2. M. J. Driscoll, B. Atefi, D. D. Lanning, "An Evaluation of the Breed/Burn Fast Reactor Concept," MITNE-229, Dec. 1979.
3. L. P. Feoktistov, "An Analysis of a Concept of a Physically Safe Reactor," Preprint IAE-4605/4 (in Russian), 1988.
4. E. Teller, M. Ishikawa, and L. Wood, *Completely Automated Nuclear Power Reactors for Long-Term Operation*, Proc. of the Frontiers in Physics Symposium, American Physical Society and the American Association of Physics Teachers Texas Meeting, Lubbock, Texas, United States, 1995.
5. H. Van Dam, "The Self-Stabilizing Criticality Wave Reactor," Proc. of the 10<sup>th</sup> International Conference on Emerging Nuclear Energy Systems, ICENES 2000, p. 188, NRG, Petten, Netherlands, 2000
6. H. Sekimoto, K. Ryu, and Y. Yoshimura, "CANDLE: the New Burn Strategy", *Nuclear Science and Engineering*, 139, 1-12, 2001
7. P. Yarsky, M. J. Driscoll, and P. Hejzlar, *Integrated Design of a Breed and Burn Gas-Cooled Fast Reactor Core*, MIT-ANP-TR-107, 2005
8. C. Ahlfeld, P. Hejzlar, R. Petroski, T. A. Weaver, A. Odedra, T. Burke, J. McWhirter, "Cost and Safety Features of 500 MWe to 1150 MWe Traveling-Wave Reactor Plants, *Trans. Am. Nucl. Soc.*, 101, pp 491-492, November 15-19, 2009.
9. K. D. Weaver, C. Ahlfeld, J. Gilleland, C. Whitmer, and G. Zimmerman, "Extending the Nuclear Fuel Cycle with Traveling-Wave Reactors," Paper 9294, *Proc. of Global 2009*, Paris, France, September 6-11, 2009
10. T. Ellis, R. Petroski, P. Hejzlar, G. Zimmerman, D. McAlees, C. Whitmer, N. Touran, J. Hejzlar, K. Weaver, J. C. Walter, J. McWhirter, C. Ahlfeld, T. Burke, A. Odedra, R. Hyde, J. Gilleland, and L. Wood, "Traveling Wave Reactors: A Truly Sustainable and Full-Scale Resource for Global Energy Needs," ICAPP10, San Diego, June 13-17, 2010.

## Lead-Cooled Fast Reactor

*Abstract—Sodium-cooled fast reactors (SFRs) have been the historical choice of fast reactor to enable full uranium conversion to higher actinides and burning of actinides. However, SFRs are not presently economic with capital costs estimated to be significantly greater than LWRs. Lead-cooled fast reactors (LFRs) are similar in design to SFRs. LFRs should have lower costs than SFRs because (1) lead is less chemically reactive than sodium or potassium resulting in simplified plant design and (2) lead-coolants have higher boiling point than sodium, and can operate at higher temperatures and thus be more efficient in converting heat to electricity. However, structural material corrosion has limited the actual peak coolant temperatures of LFRs to levels lower than SFRs resulting in lower thermal-to-electricity efficiency. Corrosion problems also limit the velocity of lead coolant through the reactor core, resulting in larger, more costly, reactor cores. New high-temperature metal alloys that are corrosion resistant in lead have been developed in the laboratory but have not been tested under the full set of credible reactor conditions. If the corrosion resistant characteristics of these alloys are confirmed for realistic reactor conditions and assuming that there are no other unexpected challenges, LFRs could become an attractive alternative to SFRs.*

Fast reactors have traditionally used liquid metal coolants because of their excellent nuclear properties in a fast reactor core and their good heat transport properties. Sodium and sodium-potassium mixtures have been preferred because of their low corrosion rates with typical metals of construction. However, there are disadvantages to sodium and potassium: (1) their boiling points limit the peak reactor coolant temperatures to ~550°C and (2) they are highly chemically reactive when exposed to air or water. The limits on peak coolant temperatures limit power plant efficiency and the chemical reactivity adds major complications to the power plant design.

These difficulties can be avoided by using lead or lead-bismuth liquid coolants. The high boiling point of lead (1620°C) allows much higher peak reactor coolant temperatures

(~700°C) with higher thermal-to-electrical efficiencies. Lead is much less chemically reactive in air or water, allowing significant plant simplification. Some of these desirable characteristics led Russia to develop and deploy lead-cooled fast reactors for their Alpha-Class fast attack submarines. The Russians have also developed designs for lead-bismuth-cooled commercial fast reactors and recently announced plans to develop a small modular lead-cooled fast reactor with a power output of 100 MW(e).

Lead is corrosive. It can dissolve many other metals. With careful control of lead chemistry, protective oxide layers can be created on metal surfaces to reduce corrosion. However, it is thought that the difficulty in controlling corrosion was one of the major factors leading to the Russian decision not to build additional submarines with lead-cooled reactors. The difficulties in corrosion control limit lead-cooled reactors to coolant exit temperatures between 400 and 500°C.

A cooperative program between MIT, Los Alamos National Laboratory, Idaho National Laboratory, and the DOE has developed a series of new alloys [1,2,3] that may allow operating temperatures to 700°C, and enable high-power-density, lower-cost reactor cores. A series of Fe-Cr-Si alloys were developed based on Fe-12 wt% Cr plus 1-2.5 wt% Si chemistry. The Fe-12Cr-2Si alloy has demonstrated a resistance to corrosion in Pb/Pb-Bi eutectic that will allow operation of materials at temperatures to 700°C. The dual oxide (Cr based/Si based) layer provides a high degree of protection.

While these alloys exhibited the requisite corrosion resistance, these alloys do not meet strength requirements for cladding applications. They must be combined with stronger metals to form bimetallic tubing with both the clad strength and corrosion resistance that is required. The alloy can be fabricated in the form of either: (1) welding wire that can then be used as an overlay for either an extrusion billet (for tubing, piping, or cladding production) or as an overlay for more complex shapes or (2) as a sleeve that can be used as either an insert or an overlay that can be co-extruded with the base structural material. Functionally graded composites consisting of a corrosion resistant layer on a structural alloy have been produced in two forms: (1) tubing suitable for piping applications and (2) tubing suitable for fuel cladding applications [4]. Significant work, including radiation tests, is required before this can be considered a demonstrated solution to address lead-cooled reactor constraints.

For complete assessment of the LFR potential, the impact of (1) the higher freezing temperature of lead, compared to sodium, on the design of the primary coolant circuit so as to avoid partial plugging need and (2) compatibility of the lead coolant temperature limits on the design of the secondary circuit (whether a supercritical CO<sub>2</sub> cycle or a superheat steam turbine cycle) should be evaluated.

## CITATIONS AND NOTES

1. Ballinger, R. G. and Lim, J. "An Overview of Corrosion Issues for the Design and Operation of lead and Lead-Bismuth Cooled Reactor Systems", *Nuclear Technology*, 147 (3), September, 2004, pp. 418-435
2. Loewen, E. P., Ballinger, R. G., and Lim, J. "Corrosion Studies in Support of a Medium Power Lead Cooled Reactor", *Nuclear Technology*, 147 (3), September 2004, pp. 436-457.
3. J. Lim, R. G. Ballinger, P. W. Stahle, N. Li, "Effects of Chromium and Silicon on Iron-Alloy Corrosion in Pb-Bi Eutectic", *ANS Annual Summer Meeting, Reno, NV*, June 4-8, 2006.
4. Short, M. "Manufacturing of Functionally Graded, Si enriched Ferritic Steels", PHD thesis, in progress, Nuclear Science and Engineering Department, April 2010.

## Advanced High-Temperature Reactor

*Abstract—In the last decade, a new reactor concept has been proposed: the Advanced High-Temperature Reactor (AHTR) that uses liquid fluoride salts as coolants and the coated-particle fuel developed for gas-cooled high-temperature reactors. It is also called the fluoride-salt high-temperature reactor (FHR). It has potentially promising economics because of the compact primary systems that operate at low pressures with large thermal margins and sufficiently high coolant temperatures to enable use of higher efficiency power cycles. Unlike other reactors, it naturally uses a combined uranium-thorium fuel cycle in a once-through mode and may have a conversion ratio near unity if operated with a closed fuel cycle. In the context of fuel cycles it is a radical departure because one variant can use flowing pebble-bed fuel to enable three dimensional optimization of the reactor core with time that creates new fuel cycle options that are today only partly understood. The reactor does not have any single technical issue that determines technical viability when operated at temperatures below 700 °C, but rather there has been insufficient work to date to understand the potential capabilities and limitations. Since the coolant freezes at several hundred degrees C, maintaining such high temperatures at all times in the coolant circuit is important to reliability.*

The AHTR is a new reactor concept [1] that uses the traditional gas-cooled high-temperature reactor fuel and a liquid salt coolant. The fuel is a coated-particle fuel incorporated into a graphite matrix. The graphite matrix can be in the form of prismatic fuel blocks, or fuel assemblies, or pebbles—spheres several centimeters in diameter. Test and prototype helium-cooled high-temperature reactors have been built with (1) prismatic fuel blocks in the U.S and Japan and (2) pebble-bed fuel in Germany and China. China is currently constructing a prototype helium-cooled pebble bed reactor. The AHTR, like high-temperature gas-cooled reactors, has a thermal to intermediate neutron spectrum.

Several liquid salt coolants are being considered for the AHTR. The leading candidate is a mixture of  ${}^7\text{LiF}$  and  $\text{BeF}_2$ . The coolant exit temperatures would be  $\sim 700^\circ\text{C}$  resulting in a reactor with a high thermal-to-electricity efficiency. The coolant is the same fluid used in the molten salt reactor (MSR) except unlike the MSR with fuel dissolved in the coolant, the AHTR uses a clean coolant and thus avoids the corrosion challenges associated with earlier concepts. Two small molten salt test reactors were built. One was for the Aircraft Nuclear Propulsion Program in the 1950s. The second was for the Molten Salt Breeder Reactor program of the 1960s. MSRs can be sustainable reactors with conversion ratios near unity using a thorium fuel cycle. The pebble bed AHTR in some respects can be considered a solid-fuel variant of the MSR. (More recently, the French have initiated an R&D program for a fast-spectrum MSR [2]. This is a more advanced reactor concept than the concepts described in this chapter with the unusual characteristics of a very low fissile fuel inventories, a fast-spectrum reactor with a large negative void coefficient, and a long-term candidate for efficient burning of fissile materials).

The pebble-bed AHTR may enable a modified thorium-uranium 235 fuel cycle for an open cycle with improved uranium utilization or potentially a closed thorium-uranium 233 fuel cycle with a conversion ratio near unity. The unusual fuel cycle options are a consequence of (1) the pebble fuel and (2) liquid cooling efficiency that avoids local hot spots. In a pebble-bed reactor, the fuel consists of pebbles several centimeters in diameter. These pebbles move through the reactor core over a period of a few weeks producing power inside the reactor core. As pebbles exit the reactor, radiation detectors determine their burnup. Pebbles with low burnup are recycled back to the reactor core. Pebbles with high burnup become SNF.



There are several unique consequences of flowing fuel—all which increase the fuel efficiency of this reactor and create unusual fuel cycle options.

- *Uniform SNF.* All of the SNF is fully irradiated. In all other solid-fuel reactors the center of the fuel assemblies are fully irradiated but there is only partly burnt fuel at the end of the fuel assemblies that are at the edge of the reactor core. In a pebble-bed reactor, pebbles with low burnup are cycled back into the reactor until they have reached full burnup allowing full utilization of all fuel.
- *Three dimensional fuel geometry.* The pebbles in the reactor core can be arranged in three dimensional geometries to maximize fuel performance. Laboratory experiments demonstrated [3] that pebbles in a pebble bed reactor move in near plug flow through the reactor core. By proper placement of pebbles at the entrance to the reactor, their flow through the reactor can be predicted and controlled. In effect three dimensional zoned reactor cores can be created with variable composition of fuel across the reactor core to maximize the conversion ratio. Three dimensional zoning can be done in traditional reactors with traditional fuel assemblies; but, as the fuel is burnt, its composition changes. Because of the extended time to refuel reactors, it is not viable to rearrange traditional fuel assemblies every few weeks to optimize the reactor core as fuel is burnt. In contrast with online refueling of a pebble bed reactor, the AHTR core can be continuously optimized in three dimensions.

Recent work [4] shows that the combination of three-dimensional zoned reactor cores with moving pebbles may enable significant improvements in fuel utilization with a combined uranium-thorium fuel cycle. The fresh pebbles with thorium and some uranium initially form a blanket around the reactor core to both absorb neutrons to produce fuel and to be a radiation shield around the reactor core. After the fissile content is increased, these pebbles are used as fuel.

As a new reactor concept, there have been limited studies—thus the difficulty to credibly assess this concept. No single technological barrier has been identified (such as corrosion in lead-cooled reactors) when the maximum temperature is kept below 700 C. There are a series of technical questions. The power densities (30 to 60 kW/liter) are high for high-temperature reactor fuel but the peak fuel temperatures are much lower than in a gas-cooled high-temperature reactor, which are typically assumed to reach higher coolant temperatures. Avoiding plugging of the coolant circuit under all operating conditions needs to be ascertained.

Associated with all high temperature reactors (and high-temperature advanced fossil and solar systems) is the need to develop power cycles to fully take advantage of the higher temperatures to produce electricity more efficiently. It may be viable to extend traditional steam power cycles to higher temperatures. Closed helium cycles begin to become an option at these temperatures. Supercritical carbon dioxide power cycles have the potential for significantly lower costs and higher efficiencies but are at the laboratory stage of development. Last, for the AHTR, there is the option for an air Brayton power cycle using mostly existing technology—the heat to electricity efficiency is somewhat lower (40% versus 45%) than other options but such a power cycle requires no water cooling and may enable a wider set of siting options.

The initial assessments indicate the potential for lower costs than a LWR with a once-through fuel cycle—partly because of the higher thermal-to-electricity efficiency from the higher operating temperatures and partly because of the small physical size of the reactor plant. For a closed fuel cycle there would be significant challenges relative to LWR or SFR

SNF in terms of recycling the SNF. The high-temperature reactor fuel that is the basis for this concept is difficult to reprocess and thorium fuel cycles generate  $^{232}\text{U}$  that has a decay product with a 2.6 MeV gamma ray that makes fuel fabrication difficult. The fuel has several other characteristics that create significant technical barriers against diversion relative to other types of SNF—see appendix C.

## CITATIONS AND NOTES

1. C. W. Forsberg, P. S. Pickard, and P. F. Peterson, "A Molten-Salt-Cooled Advanced High-Temperature Reactor for Production of Hydrogen and Electricity," *Nuclear Technology*, 144, pp. 289-302 (December 2003).
2. E. Merle-Lucotte, D. Heuer, M. Allibert, X. Doligez, and V. Ghetta, "Minimizing the Fissile Inventory of the Molten Salt Fast Reactor," *Advances in Fuel Management IV (ANFM 2009)*, Hilton Head Island, South Carolina, USA, April 12-15, 2009.
3. A. C. Kadak and M. Z. Bazant, "Pebble Flow Experiments for Pebble Bed Reactors," 2nd International Topical Meeting on High-Temperature Reactor Technology, Beijing, China, September 22-24, 2004.
4. A. T. Cisneros, E. Greenspan, and P. Peterson, "Use of Thorium Blankets in a Pebble Bed Advanced High-Temperature Reactor," Paper: 10046, *Proc. of ICAPP'10, San Diego, California*, June 13-17, 2010.

## FUEL CYCLE TECHNOLOGIES

Independent of reactors, there are a series of fuel cycle technologies that could have major impacts on future fuel cycle choices.

### Uranium from Seawater

*Abstract—Seawater contains about four billion tons of uranium. Recent Japanese research suggests that the cost of seawater uranium may ultimately be sufficiently low to place an upper limit on the cost of uranium, which may enable a once-through fuel cycle to be economically competitive for centuries. The economic viability of this option depends upon the long-term durability of the ion exchange media and other equipment in seawater. The data to fully evaluate the commercial viability of this option do not now exist. If there was high confidence in the economics of seawater uranium (high or low), it could be major factor in fuel cycle choices.*

This potential source of uranium has long intrigued fuel cycle researchers despite its low concentration ( $\sim 3.3$  ppb), because of the immensity of the total resource: about  $4 \times 10^9$  metric tons. The challenge is to devise an economic system to process the large volumes of seawater required. The most recent approaches for uranium from seawater have involved the use of ocean currents or wave action to promote contact with and flow through fibrous ion exchange media. The collector could be considered a type of artificial kelp that selectively extracts uranium from seawater.

MIT carried out a significant program [1,2] in this area under DOE support in the early 1980s. The highly selective ion exchange medium, acrylic amidoxime, identified by our tests remains the material of choice today. Since then, the only continuing research effort has been conducted in Japan, which now has reached the stage of module tests in the ocean. Their current [3] cost estimate, based on demonstrated capabilities, is approximately 750 \$/kg, with future projections as low as 125 to 210 \$/kg. Updating MIT models from 1984 for a similar concept [2] give 1170 \$/kg today and as low as 117 \$/kg if the long term Japanese

performance goals can be achieved. Recent Japanese studies indicate significant progress in reducing uranium recovery costs [4]

Thus this option can neither be planned on, nor ruled out at present. A modest test program in cooperation with Japan to determine whether plausible future costs can be reduced to  $\leq 300$  \$/kg would appear prudent because of the profound implications if successful.

## CITATIONS AND NOTES

1. M.J. Driscoll, "An Artificial Kelp Farm Concept for the Extraction of Uranium from Seawater," MITNE-260, April 1984
2. F.R. Best and M.J. Driscoll, "Prospects for the Recovery of Uranium from Seawater," *Nuclear Technology*, Vol. 73, No. 1, April 1986
3. "Confirming Cost Estimations of Uranium Collection from Seawater," (anon.), JAEA R&D Review section 4-5, page 63 (2006)
4. M. Tamada, "Current Status of Technology for Collection of Uranium from Seawater", Erice Seminar, 2009.

### Alternative Fast Reactor Startup Strategies Using Low-Enriched Uranium, a Once-Through Fuel Cycle, and Transitioning to a Closed Fuel Cycle

*Abstract—Our analysis indicates that a conversion ratio near unity is preferred for sustainable fast reactors and that we are not tightly constrained by uranium resources. The changing ground rules may create new startup strategies for fast reactors. Preliminary assessments indicate that a conversion ratio of unity should allow startup of fast reactors on low-enriched uranium rather than plutonium or medium-enriched (weapons useable) uranium. There is also the possibility that a fast reactor could be developed with (1) a once-through fuel cycle with a conversion ratio near unity and (2) fuel cycle costs near the traditional LWR once-through fuel cycle. If this can be achieved, fast reactors could be developed and initially deployed using a once-through fuel cycle. The deployment of fast reactors would depend upon an economic fast reactor without the economic necessity to simultaneously develop and deploy the associated closed fuel cycle. If a large reactor fleet was built and fuel costs increased, the SNF could be recycled to create the classic fast reactor fuel cycle.*

In a nuclear reactor fission produces neutrons that (1) continue the fission process, (2) are lost by leakage, absorption in structural materials or absorption in the coolant, and (3) are absorbed by U-238 or Th-232 and converted into fissile Pu-239 or U-233. A sustainable reactor with a high conversion ratio requires a high concentration of fissile materials (U-235, Pu-239, or U-233) to produce sufficient neutrons to breed fuel. In a fast reactor the conversion ratio is maximized by minimizing the loss of neutrons and maximizing the number of neutrons absorbed by fertile materials. This is traditionally accomplished by surrounding the reactor core with fertile U-238 and placing U-238 zones inside the reactor core. Neutrons leak from zones with high fissile fractions and are captured by the  $^{238}\text{U}$  which is converted into Pu-239.

If a conversion ratio of unity is acceptable, not as many neutrons are required to produce Pu-239. The external blanket of U-238 can be eliminated. If these neutrons that were going to the blanket can be reflected back into the reactor core for fission, the fissile concentration of the reactor core can be reduced. Recent advances in neutron reflectors [1] suggest that this may be possible. If confirmed, a fast reactor could be started on low-enriched uranium and

avoid some of the nonproliferation challenges associated with high-enriched uranium. The preferred startup strategy for fast reactors would be low-enriched uranium. LWR SNF would not need to be reprocessed to provide plutonium for the startup of commercial fast reactors.

If fast reactors can be started up on low enriched uranium, the follow-up question is: Can fast reactors be operated economically on a once-through fuel cycle like an LWR? The fast reactor will have a significantly higher enrichment than a LWR. If both reactors are to have the same fuel cycle costs, the fast reactor SNF burnup will need to be higher than an LWR. Fast reactor fuels traditionally have higher fuel burnups than LWRs because with a conversion ratio of unity or higher, the reactor is producing fissile fuel as fast as it is being consumed. In contrast, in LWRs the fissile material is burnt up and the concurrent reduction in reactivity limits ultimate fuel burnup. If sufficiently high burnup is obtainable, the fuel cycle costs for a once-through fast reactor should be equal to an LWR. One could develop and deploy fast reactors (assuming that the capital cost is equivalent to an LWR) on a once-through fuel cycle with the option of later converting to a closed fuel cycle using the fast reactor SNF. The required SNF burnup for this option would likely be less than the sustainable once-through fast reactor discussed earlier. Capital costs for fast reactors remain a challenge.

## CITATIONS AND NOTES

1. R. R. Macdonald and M. J. Driscoll, "Magnesium Oxide: An Improved Reflector for Blanket-Free Fast Reactors," Transactions of the American Nuclear Society, San Diego, June 2010.

### Borehole Disposal of Long-Lived Radionuclides

*Abstract—Advances in the oil/gas/geothermal well drilling technology have motivated renewed attention to the use of deep boreholes for disposal of intact SNF assemblies or separated wastes from reprocessing—including options such as disposal of minor actinides. A single borehole can hold 20 years of SNF discharged from a reactor. Boreholes would be drilled several kilometers into low-permeability granitic basement rock that also provides a chemically reducing environment—conditions that can provide secure geological isolation. The depth of disposal is significantly greater than with traditional geological repositories. As described earlier (Chapter 5), boreholes have potential advantages over conventional geological repositories for disposal of low-volume waste that have high decay heat or wastes with radionuclides that have long half-lives.*

As an advanced technology, its impact on the fuel cycle may be enhanced by its institutional characteristics. Basement rocks at drillable depths are more widely available than other geologies. It may enable economically viable smaller repositories for regional repositories or provide a technology for countries with only a few reactors to dispose of their HLW or SNF in a way that it may be difficult to recover with potential incentives in the context of nonproliferation (See waste management chapter).

### Collocation and Integration of Reprocessing, Fuel Fabrication, and Repository Facilities.

*Abstract—The initial development of closed fuel cycles occurred before the development of geological repositories to dispose of long-lived wastes. As a consequence, it was assumed that reprocessing, fuel fabrication, and repository facilities would be separately sited. Our assessment*

*is that it will be many decades before the U.S. adopts a closed fuel cycle, and thus the possibility exists that a geological repository for disposal of wastes will be sited before implementation of any closed fuel cycle. This creates the option of collocation and integration of reprocessing and fuel fabrication, with the repository facilities, which could result in potentially major reductions in closed fuel cycle costs and risks. It enables technical options for termination of safeguards on wastes containing fissile materials. Collocation and integration of back-end fuel cycle facilities may also aid the siting of future repositories. A reprocessing-fabrication facility would provide many more direct and indirect jobs than would a geological repository. It is not known if the benefits of collocating and integrating backend facilities are sufficiently large to drive fuel cycle choices.*

In the 1950s it was thought that the cost of the closed fuel cycle would be low. This was partly based on the experience of reprocessing defense SNF at the Hanford site with onsite disposal of wastes. However, the improper disposal of those wastes resulted in high-cost remedial action programs. By the 1960s it was understood that geological disposal should be used for the ultimate disposal of many wastes. In the 1960s and early 1970s, the U.S. government encouraged private construction of reprocessing and fuel fabrication facilities. Because no geological repository existed, there was no option for collocation of reprocessing, fabrication, and repository facilities. Reprocessing, fabrication, and repository facilities would be separately located.

Separate siting of closed fuel cycle reprocessing and fabrication facilities necessitates storage and transport of wastes to the geological repository. In turn, these requirements favor reprocessing and fabrication processes being chosen to minimize waste volumes. However, by the 1980s it was recognized that the costs of geological repositories for the disposal of low-heat wastes (clad and hardware, transuranics, low-level, failed equipment, etc.) would be inexpensive but that the costs of disposal of high-heat wastes (spent nuclear fuel and high-level waste) would be significant. Most of the wastes from reprocessing and fuel fabrication plants are low-heat wastes. If the reprocessing and fabrication plants were collocated and integrated with the repository [1], the restrictions on waste volumes for low-heat wastes would be dramatically relaxed with several impacts.

- *Cost.* Relaxation of waste volume constraints enables the use of lower cost processes in reprocessing (such as the chemical decladding of SNF that was done at Hanford) and fabrication plants. The recognition that collocation of backend facilities could result in significant cost savings resulted in German plans [2] in the 1970s to collocate and integrate all fuel cycle facilities at Gorleben—their proposed repository site. Because of the German decision to use a once-through fuel cycle, that option was never implemented.
- *Risk.* Facility collocation eliminates some shipping and storage requirements (except storage of HLW before disposal). Facility integration has the potential to significantly reduce the process complexity by reducing the requirements to minimize waste volumes with resultant reductions in potential accident risks.
- *Repository performance.* The relaxation of waste volume constraints allows lower waste loadings in final waste forms. This, in turn, (1) enables the use of waste forms with potentially superior performance but that for technical reasons have low waste loadings, (2) reduces radiation damage to the waste form over time and (3) allows isotopic dilution of solubility-limited radionuclides to boost performance.

- *Safeguards.* Many wastes contain fissile materials. If wastes are converted into waste forms with low waste loadings and very low concentrations of fissile materials, safeguards can be terminated on these wastes because the fissile materials are not practically recoverable.

There have not been any assessments of the technical, economic, and institutional implications of separate versus collocated-integrated backend fuel cycle facilities for many decades. It is not known whether the benefits are so large as to drive facility siting decisions—assuming that closed fuel cycles are adopted after the siting of a geological repository.

## CITATIONS AND NOTES

1. C. Forsberg, "Collocation and Integration of Reprocessing, Fabrication, and Repository, Facilities to Reduce Closed Fuel Cycle Costs and Risks", *Proceedings of ICAPP '10*, San Diego, CA, USA, June 13-17, 2010
2. F. Barnaby, "Gorleben Revisited", *Ambio*, 8 (4), 182-183 (1979).

## NUCLEAR RENEWABLE FUTURES

*Abstract—The largest uncertainty in understanding fuel cycle futures is the size of the nuclear enterprise that determines when alternative fuel cycles may be desirable. Historically, nuclear energy has been considered as a source of base-load electricity. This composes a quarter to a third of the world's energy market. However, if nuclear energy is used for other applications, the total size of the nuclear enterprise could be much larger. There are several candidate markets: (1) variable daily, weekly, and seasonal electricity production by coupling base-load nuclear reactors to gigawatt-year energy storage systems and (2) providing heat and hydrogen for production of liquid fuels from fossil, biomass, and carbon-dioxide sources. Viability depends upon both the economics of nuclear power and successful development and commercialization of nuclear-user technologies such as gigawatt-year heat storage, high-temperature electrolysis for hydrogen production, and hydrocracking of lignin. Developments in this area could define the size of the nuclear enterprise and reactor requirements (such as required peak temperature) that, in turn, drive many fuel cycle decisions.*

*Variable electricity production.* Electricity demand varies with the time of day, a three-day weather-related cycle in the mid latitudes, a weekly cycle associated with the work week, and the seasons. Today variable electricity demand is primarily met with fossil plants that have low capital costs and high operating costs. If concerns about climate change limit atmospheric greenhouse gas releases, the low-carbon options are nuclear energy, fossil fuels with carbon dioxide sequestration, and renewables. These options have high capital costs, have low operating costs, and are expensive choices to meet variable power loads. Renewable electricity production does not match electricity demand (peak wind at night in the spring—time of lowest electric demand; solar peaks in June but electricity demand peaks in August).

Three storage media have been identified for seasonal electricity storage: water, heat, and hydrogen. Hydroelectricity is geographically and capacity limited. The other two options couple with nuclear power plants. The nuclear geothermal option uses heat from reactors at time of low electricity demand to heat a large volume of underground rock (500 m cube per gigawatt-year of heat storage). At times of high electricity demand the nuclear plant produces electricity and the heated rock becomes part of a geothermal electricity production

system [1]. The nuclear power plant operates continuously at base load. This is intrinsically a large scale energy storage system because it is not viable to store small quantities of heat underground. The high surface to volume ratio of the rock results in unacceptable quantities of heat leaking out of small systems. These and other systems are being developed but significant R&D is required before decisions can be made on the viability of gigawatt-year energy storage systems.

*Liquid fuels Production.* The United States consumes 20 million barrels of oil per day—39% of the nation's energy consumption. Sixty percent of that oil is imported. Most of the oil [2] is used in transportation [transportation: 13.66; industry: 4.94; residential and commercial: 1.10, and electricity generation: 0.22]. Oil consumption is the largest source of greenhouse gas releases in the United States, a major national security challenge for the U.S., and the largest single component of our large national trade deficits. There are large incentives to reduce oil consumption. Existing technologies such as high-efficiency vehicles and near-term technologies such as plug-in hybrid vehicles may reduce oil demand by half [3] for the whole transportation sector. However, the transport sector will still need a high-energy-density transportable fuel.

The production of liquid fuels requires a carbon source, a hydrogen source, and energy. Historically crude oil provided all three in the production of liquid fuels. Today natural gas provides some of that energy. Refineries consume about 7% of the total energy in the U.S. The less the feedstock resembles gasoline or diesel fuel, the more energy is required in the conversion process. For a coal liquefaction plant the energy used in and the carbon dioxide released from the coal liquefaction plant exceeds the energy content of the liquid fuel and the carbon dioxide released when the fuel is burnt. For a biomass to liquid fuels plant, a third or more of the biomass may be consumed as boiler fuel at the biorefinery.

Nuclear energy can provide external heat and hydrogen for liquid fuels production. If fossil fuels are the feedstock, consumption of fossil fuels (oil, natural gas, coal) at the refinery and greenhouse gas releases from the refinery can be avoided. If biomass is the feedstock, the liquid fuels production per ton of biomass can be doubled or tripled—potentially avoiding the primary limitation of biomass: insufficient biomass resources to replace oil.

These non-traditional applications of nuclear energy may drive reactor choices and indirectly fuel cycle choices. Most of the applications can be met by existing light water reactors; however, some applications require high-temperature heat and in many other cases there are large incentives for heat provided at 700°C versus the 300°C temperature heat provided by LWRs. This would require the development of high-temperature reactors. For some applications there would be large incentives to develop smaller reactor sizes.

## CITATIONS AND NOTES

1. Y. H. Lee, C. W. Forsberg, M. J. Driscoll, and B. Sapiie "Options for Nuclear-Geothermal Gigawatt-Year Peak Electricity Storage Systems", *2010 International Congress on Advances in Nuclear Power Plants (ICAPP 10)*, San Diego, (13-17 June 2010).
2. Energy Information Administration, *Annual Energy Outlook 2008 with Projections to 2030*, U.S. Department of Energy, [http://www.eia.doe.gov/oiaf/aeo/aeoref\\_tab.html](http://www.eia.doe.gov/oiaf/aeo/aeoref_tab.html) (2009)
3. C.W. Forsberg, "Nuclear Energy for a Low-Carbon-Dioxide-Emission Transportation System with Liquid Fuels," *Nuclear Technology*, 164, 348-367 (December 2008).

# Appendix C — High-Temperature Reactors with Coated-Particle Fuel

As in the 2003 *Future of Nuclear Power Study*, we recommend a public-private program to determine the commercial viability of high-temperature reactors (HTRs) using coated-particle fuel. This recommendation is based on five anticipated desirable characteristics of these reactors: production of high-temperature heat that enables more efficient production of electricity, may simplify siting due to reduced water requirements for power plant cooling, and supports liquid fuels production; high levels of safety with less dependence on reactor operations relative to other types of power reactors; spent nuclear fuel (SNF) with reduced concerns relative to safeguards and nonproliferation; the capability to burn a high-fraction of the fissile fuel; and excellent performance of the spent nuclear fuel as a waste form.

HTRs are not new. Test and demonstration reactors were built in the United States and Germany in the 1970s. More recently, Japan and China have built test reactors and China is in the process of building a demonstration plant. The U.S. Department of Energy Next Generation Nuclear Plant (NGNP) program recently announced awards to two industrial teams led by Westinghouse and General Atomics to undertake preliminary design of a commercial prototype HTR. The commercial interest in HTRs is a result of several factors: (1) growing markets for high-temperature heat; (2) improvements in fuel reliability and reactor designs that may significantly improve economic viability; and (3) the potential for economic smaller-scale nuclear power plants.

## POTENTIAL MARKETS

LWRs have peak coolant temperatures of  $\sim 300^{\circ}\text{C}$  and are primarily used for the production of electricity. HTRs today have peak coolant temperatures between  $700$  and  $850^{\circ}\text{C}$  with the long-term potential of higher temperatures. Higher exit coolant temperatures enable the more efficient production of electricity (40 to 50% versus efficiencies in the mid 30s for LWRs), and reduced demand for power plant cooling water.

There is the potential for HTRs to simplify plant siting by eliminating the need for power-plant cooling water. Conventional thermal power stations (nuclear, fossil, geothermal, solar thermal, etc.) require large quantities of cooling water. The siting of nuclear plants is made more difficult because people and cities are usually near water (rivers, lakes, and oceans). If the requirement for cooling water is eliminated, the reactor siting options are greatly expanded. There are existing, but expensive, industrial dry cooling technologies. The dry-cooling is more favorable for HTRs relative to LWRs because more efficient plants require less cooling per unit of electricity output. HTRs have a second option—direct air-cooled Brayton power cycles with no water requirements. Only limited work has been done on such options.



The HTRs can be used to provide high-temperature heat to chemical plants, refineries, steel production, and other industrial applications—markets currently served by fossil fuels and that are responsible for about 16% of the total greenhouse gas emissions of the U.S. The largest high-temperature process heat market are refineries that consume about 7% of the nation's total energy demand—about equal to the total energy output of the nation's existing nuclear power plants.

The longer-term incentive for the HTR is its potential for liquid fuels production while minimizing greenhouse gas releases. Liquid fuels can be produced from oil, natural gas, oil sands, oil shale, coal, and biomass. However, the less the feedstock resembles gasoline or diesel fuel, the more energy is required to convert the feedstock into gasoline and diesel fuel. While the refining of light crude oil consumes ~15% of the crude oil in the refining process, the energy consumed by a coal liquefaction plant exceeds the energy value of the gasoline and diesel fuel that is produced. Because we are transitioning from light crude oil to alternative feedstocks, the carbon dioxide emissions from the production of a gallon of gasoline or diesel fuel are expected to rise over the next several decades.

If external energy sources are available for refineries, coal liquefaction plants, and biorefineries, greenhouse gas emissions can be minimized. For biofuels, the availability of external energy sources for biorefineries determines the contribution of biofuels. It has been estimated that the U.S. could ultimately produce 1.3 billion tons of renewable biomass per year without major impacts on food and fiber production. If burned, the energy output would equal about 10 million barrels of diesel fuel per day. If converted to ethanol, the energy value of the ethanol would be equivalent to 5 million barrels of diesel per day with most of the remaining energy used in the biomass-to-fuels production process. If external heat and/or hydrogen are available, the same biomass could produce about 12 million barrels of diesel fuel per day. Biofuels have the potential to replace oil in the transport sector but only if biorefineries have external energy sources. Because plants extract carbon dioxide from the atmosphere, the use of biofuels does not increase greenhouse gas emissions to the atmosphere provided that a low-carbon energy source provides the energy to the biorefinery.

Recent reviews (Forsberg 2008) have evaluated the use of nuclear energy for liquid fuels production. Some applications can use lower temperature heat from LWRs but many applications require high-temperature heat. The largest long-term market may be the production of gasoline and diesel from biomass using high-temperature processing and hydrogen. Biorefinery processes (Ondrey 2010) today convert only a fraction of the biomass to gasoline and burn the remaining biomass to provide the heat and hydrogen for the biorefinery. By replacing the biomass consumed in operating the biorefinery, an HTR could triple fuel yields per ton of biomass.

## **TECHNOLOGY DESCRIPTION**

There are various designs of HTRs but all use the same basic coated-particle fuel. The potentially unique societal benefits (safety, safeguards and nonproliferation, fissile fuel burning, and waste-form performance) of HTRs are associated with the characteristics of this fuel. Potential disadvantages (such as higher fuel manufacturing costs) are also associated with this fuel.

The fuel (Figure C.1) consists of small particles of uranium or plutonium oxides or oxycarbides surrounded by layers of carbon-containing materials and silicon carbide (or sometimes zirconium carbide) with the coated particles embedded in a graphite matrix. The particles are the size of grains of sand. The graphite matrix can be in several different geometric forms—usually pebbles the size of tennis balls or hexagonal blocks. This fuel form has several unique characteristics:

- ❑ *Temperature limits.* The fuel failure temperatures are high compared to any other fuel. Initial failure of some of the particles begins above 1600°C. This is above the melting point of iron.
- ❑ *Chemical reactivity.* The chemical reactivity is low in most chemical environments with the silicon carbide being chemically inert in most environments.
- ❑ *High burnup.* Coated-particle fuel can have fuel burnups an order of magnitude greater than LWRs, thus extending fuel resources.
- ❑ *Dilute fuel.* The fissile content of the fuel is one to two orders of magnitude less than other reactor fuels. HTRs are thermal neutron reactors that require a fuel (usually uranium) and a moderator (graphite). In an HTR the fuel and moderator are combined whereas in an LWR the fuel assembly does not contain the moderator (water).

**Figure C.1 Coated-Particle Fuel in Pebble-Bed Form**

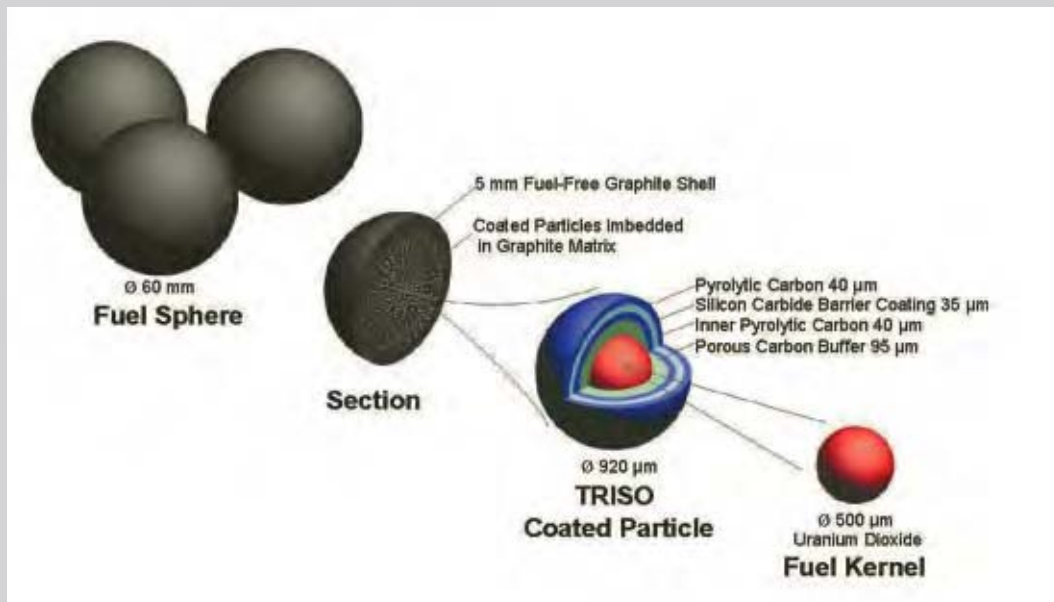

Historically, there have been mixed results in the performance of this fuel. However research and fuel testing in the last decade (Grover 2010) have demonstrated high fuel performance, high reliability, and improved understanding of fuel behavior. This has led to understanding of previous fuel failures and a confidence that that reliable high-performance fuel can be produced.

The traditional coolant to transfer heat from the reactor core to the power plant has been high-pressure helium—an inert gas. The proposed Next Generation Nuclear Plant (NGNP)

[<http://nextgenerationnuclearplant.com/index.shtml>] by the U.S. Department of Energy uses helium coolant. The technology for gas-cooled reactors is available today at temperatures up to ~850°C. Recently there has been work on using low-pressure liquid salts as coolants—the Advanced High-Temperature Reactor. Recent studies of the liquid-salt cooled AHTR (Appendix B) indicate the potential for lower costs (Peterson, Griveau), but the technology is not as fully developed. Most HTR R&D supports the use of either coolant.

The coated-particle fuel has four potential unique characteristics that may provide major societal benefits and thus the incentives for the federal government to encourage the development of such a reactor. These benefits have not been fully quantified or proven.

## Safety

The high-temperature capability of the fuel enables a different approach to reactor safety that may offer major benefits. In traditional LWRs, if a large reactor is shut down and cooling to the reactor core stops, the reactor core will heat up and melt. This is what occurred during the Three Mile Island accident. HTRs can be designed such that if the reactor cooling fails, the heat can be transferred by conduction and convection processes to the environment. This is possible because (1) the fuel can go to very high temperatures without failing and provide a very large temperature drop to enable heat transport to the environment and (2) the low power density [dilute fuel] that results in the very slow heatup of the reactor core after shutdown. In effect, many safety functions are transferred from the reactor (emergency safety systems) and the reactor operator to the fuel fabricator who is required to make a fuel that can withstand extreme conditions.

## Safeguards and Nonproliferation

The two nonproliferation concerns associated with the nuclear fuel cycle are: (1) uranium enrichment on the front end that could provide a route to producing weapons-useable high-enriched uranium and (2) plutonium separation from SNF on the back end. HTRs require low-enriched uranium and thus have most of the same front-end concerns as associated with LWRs. However, HTR SNF is different from SNF of other types of power reactors. The plutonium content of HTR SNF from currently proposed reactors would be so low as to approach the International Atomic Energy Agency limits for the termination of safeguards; that is, the difficulty of fissile material recovery is so great that anyone wanting to obtain weapons-useable materials would likely choose an alternative route to obtain such materials (Durst 2009). There are several reasons for this (Moses, 2010).

- ❑ *Burnup.* HTR SNF burnup is typically 50% higher than LWR SNF resulting in less attractive plutonium isotopic mix for weapons.
- ❑ *Plutonium content.* The SNF plutonium concentration is low (~570 ppm for some designs) and because the fissile plutonium is diluted with carbon, silicon carbide, and graphite. One must divert almost 20 m<sup>3</sup> of SNF to have a significant quantity of plutonium—the quantity of concern in terms of building a nuclear weapon.
- ❑ *Chemical form.* The technical and economic difficulties in recovering fissile materials from HTR SNF are significantly greater than for other types of SNF because (1) the fissile

fuel concentrations are one to two orders of magnitude less than any other type of SNF and (2) the chemical form of the fissile materials makes recovery difficult.

The SNF contains low-enriched uranium that could be enriched to produce weapons-useable highly-enriched uranium (HEU). Starting with enriched uranium normally reduces the effort required to produce HEU. However, this recycle uranium contains high concentrations of uranium-236 from reactor irradiation that is concentrated along with fissile uranium-235. The presence of high concentrations of uranium-236 makes this an undesirable feedstock to produce HEU.

We do not suggest that safeguards would be terminated on HTR SNF. However, there is a quantitative difference in the technical attractiveness of this SNF relative to other types of SNF in the context of nonproliferation, even though this benefit has not yet been quantified.

### Fuel cycles

HTRs have been and are being considered as an option for destruction of actinides because the fuel can go to extreme burnups in a once-through fuel cycle. Typical LWR SNF has a burnup limit of ~60,000 MWd/metric ton of heavy metal. Some fast reactor fuel can withstand a burnup of ~150,000 MWd/metric ton of heavy metal. In limited tests, SNF burnups higher than 600,000 MWd/metric ton of heavy metal have been demonstrated with coated particle fuel. The fuel creates options to burn a very large fraction of the fissile material in a single irradiation in the reactor. There have been very few fuel cycle studies for HTRs because (1) the fuel cycles are different than other options and (2) there are still unanswered questions about economic viability.

### Waste Disposal

Limited studies [Wolf 1975; Brinkmann 1990; Kirch 1990; Niephaus 1997, Forsberg 2003] indicate that because of the chemical composition (silicon-carbide coated particles and graphite matrix) of HTR SNF, it should have significantly better long-term performance in most repository geologies than LWR SNF and most waste forms from reprocessing. There have been multiple proposals to use SiC and graphite composites for improved waste packages and waste forms.

## CONCLUSIONS

The HTR and its fuel cycle are defined by its coated-particle fuel. The fuel creates the option for using nuclear energy to provide high-temperature heat for industrial applications. The high temperature delivered is still limited by the availability of structural materials but not the fuel.

The characteristics of HTR fuel offer benefits relative to LWR SNF in the areas of reactor safety, safeguards, fuel cycles, and waste management. *The major questions are associated with engineering and economics.* Because of the unique market (high-temperature heat) and societal benefits, we recommend an RD&D program to determine whether an economically viable HTR can be built.

## CITATIONS AND NOTES

- Brinkmann, H. U., et. al., "Contributions Towards the Development of a Packaging Concept for the Final Disposal of Spent HTGR Pebble Fuel," *Nuclear Engineering and Design*, 118, pp. 107-113 (1990).
- Durst, P.C., et al., *Safeguards Considerations for Pebble Bed Modular Reactor (PBMR)*, Idaho National Laboratory, INL/EXT-09-16782 (October 2009).
- Forsberg, C. et. al., "A New Repository Waste Form: Graphite-Carbon High-Level Waste (HTGR Fuel Processing and Waste Forms)," *Proc. American Nuclear Society 2003 International High-Level Waste Management Conference, Las Vegas, NV*. (March 30-April 2, 2003)
- Forsberg, C. W., "Nuclear Energy for a Low-Carbon-Dioxide-Emission Transportation System with Liquid Fuels," *Nuclear Technology*, 164, 348-367, December 2008.
- Griveau, A., F. Fardin, H. Zhao, and P.F. Peterson, "Transient Thermal Response of the PB-AHTR to Loss of Forced Cooling," proceedings of Global 2007, Boise, Idaho, September 9-13, 2007, pp. 872-884.
- Kirch, N., H. U. Brinkmann, and P. H. Brucher, "Storage and Final Disposal of Spent HTR Fuel in the Federal Republic of Germany," *Nuclear Engineering and Design*, 121, pp. 241-248 (1990)
- Moses, D. L., "Nuclear Safeguards Considerations for Pebble-Bed Reactors," *5<sup>th</sup> International Conference on High Temperature Reactor Technology HTR 2010, Prague, Czech Republic*, October 18-20, 2010.
- Niephaus, D., S. Storch, and S. Halaszovick, "Experience With the Inerim Storage of Spent HTR Fuel Elements and a View to Necessary Measures for Final Disposal," *Technologies for Gas Cooled Reactor Decommissioning, Fuel Storage, and Waste Disposal*, IAEA-TECDOC-1043, International Atomic Energy Agency (1997).
- Ondray, G. "Tryout Set for Biomass-To-Gasoline Process," *Chemical Engineering*, 117 (2), pp. 11, (February 2010)
- Peterson, P. F., "Progress in the Development of the Modular Pebble-Bed Advanced High Temperature Reactor," Global 2009 Conference, Paris, France, September 6-9, 2009.
- Wolf, J., Ultimate Storage of Spent Fuel Elements from the AVR Experimental Nuclear Power Plant in the Asse Salt Mine, GERHTR-147 (translation of JUL-1187), Institut für Chemische Technologie, Kernforschungsanlage, Julich G.m.b.H., Julich, Germany (February 1975).
- S. B. Grover, D. A. Petti and J. T. Maki, "Mission and Status of the First Two Next Generation Nuclear Plant Fuel Irradiation Experiments in the Advanced Test Reactor", Proceedings of the 18th International Conference on Nuclear Engineering ICONE18, Xi'an, China, May 17-21, 2010, Paper ICONE18-30139.
- S. B. Grover and D. A. Petti, "Completion of the First NNGP Advanced Gas Reactor Fuel Irradiation Experiment, AGR-1, in the Advanced Test Reactor", Proceedings of the 5th International Conference on High Temperature Reactor Technology HTR 2010, October 18-20, 2010, Prague, Czech Republic.

# Appendix D — Intergenerational Equity Considerations of Fuel Cycle Choices

## INTRODUCTION

Intergenerational equity is a consideration in the context of our recommendations on long-term storage of spent fuel and in waste management. A series of studies were undertaken to better understand the issues.<sup>1,2</sup> An intergenerational equity framework is an alternative methodology to assess current and future nuclear fuel cycle options.

The “achievement of intergenerational equity” is one of the cornerstones of nuclear waste management and one of the reasons for choosing geological repositories for the ultimate disposal of nuclear waste. Many nations are considering alternative fuel cycle possibilities in order to prolong uranium fuel supplies and manage nuclear waste. These strategies bring with them benefits and burdens for present and future generations; the choice between existing fuel cycles has already come to be seen as a matter of intergenerational equity. This study puts forward a way of assessing future fuel cycles in accordance with the intergenerational equity criteria presented as a broadly defined set of *moral* values built around the principle of sustainability. We characterize these values as moral values (Figure D.1) since they contribute to the environment and humankind’s safety and security as well as an overall welfare of society in terms of sustainability.

**Figure D.1 The Values Stemming From Equity and Interpreted As Different Conceptions of Sustainability**

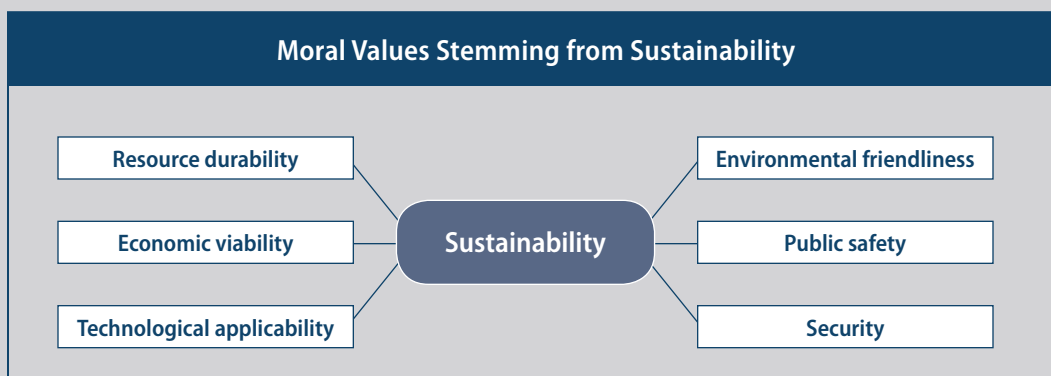

The analysis is based on the assumption that nuclear energy will play a part for at least another century. The goal of this analysis is to provide a method that will allow individuals and stakeholders to be able to assess the future developments of nuclear technology on the basis of intergenerational equity criteria, i.e. according to the distribution of benefits and burdens between generations.

In the following sections we discuss the concept of sustainable development and its relation to intergenerational equity. Values stemming from sustainability are explored, criteria for intergenerational assessment are derived from these values, and these criteria are applied to the once-through fuel cycle used today in the United States and to three future alternatives. The four fuel cycles are compared by means of the scorecard.

## **SUSTAINABILITY AND INTERGENERATIONAL EQUITY**

In conventional ethics and in discussions on human relations, terms such as “rights, justice, beneficence and malificence, social contract [etc.]” are regularly used; here the fundamental term that will help to orient us is *value*. The first question is to determine whether something is worth striving for because it serves a higher good or for its own sake. This discussion gains relevance, when it comes to the questions of how to value the environment and how to understand a human being’s relationship with his natural world.

Values are things worth striving for. However, we should not confuse values with the personal interests of individuals; values are general convictions and beliefs that people hold paramount if society is to be good. With nuclear technology it has been found that stakeholders’ value systems largely define their acceptance of courses of action. A stakeholder’s attitude towards risk acceptance relates more to the way values are prioritized and traded off against one another, rather than to how an isolated value is perceived.

Widespread concerns about the depletion of the earth’s natural resources and environmental damage have invoked discussions on the equitable sharing of benefits and the burdens between generations so as to meet “the needs of the present without compromising the ability of future generations to meet their own needs”, commonly referred to as the Brundtland definition<sup>3</sup>. As this definition implies, the equitable distribution of goods across generations is what underlies the notion of sustainability.

Sustainability and intergenerational equity are closely intertwined. Nigel Dower<sup>4</sup> argues that “the commitment to sustainability is a moral commitment to sustaining the conditions in which human well-being can be achieved, not only now and in the near future but also into the more distant future”. Dower distinguishes between two ways of understanding justice towards future generations: namely 1) sustaining justice in the way it is perceived now and 2) achieving intergenerational justice in terms of what we leave for our descendants. “If the next generation had enough resources to distribute at that time fairly but half what the current generation had, then the sustainability of justice is achieved but not intergenerational justice”. In this paper we consider intergenerational equity as it is presented in terms of Dower’s second interpretation, to the effect that the present generations’ primary concern should be with what they bequeath to future generations. Our focus herein is on *temporal equity*, or equity considerations between generations in nuclear power production

Let us focus for a while on the question of why it makes sense to view this problem in terms of generations and why it amounts to a problem of fairness. We follow here Stephen Gardiner's discussions of "The Pure Intergenerational Problem" (PIP)<sup>5</sup> in which he imagines a world of temporally distinct groups that can asymmetrically influence each other: "earlier groups have the power to impose costs on later groups [...], whereas future groups have no causal power over them". Each generation has access to a diversity of commodities. Engaging in activity with these goods culminates in present benefits and potential substantial future cost, all of which poses the problem of fairness. This also holds for nuclear energy: the present generation will mainly enjoy the benefits by depleting resources. In addition, the production of nuclear waste, and its longevity in terms of radioactivity, also creates future cost and burden issues.

We relate the PIP to the production of nuclear power and follow the "widest definition" of future generations by defining them as "people whom those presently alive will not live to meet". This definition of a generation approximately corresponds to a hundred years; we consider a hundred years to be the cut off point when distinguishing between Generations 1 and 2.

## **MORAL STANDING OF SUSTAINABILITY: VALUES AT STAKE**

There has been no consensus on how to apply the notion of sustainable development to nuclear power. Some stakeholders believe "there is a basic case for treating nuclear energy as a contribution to sustainable development"<sup>6</sup> and others state that nuclear power is inherently "unsustainable, uneconomic, dirty and dangerous".<sup>7</sup>

In this appendix we do not pretend to answer the controversial question as to whether nuclear energy is - or could possibly be - sustainable. We argue that in understanding this question we need to interpret sustainability and address the conflict of interests between people belonging to different generations. To this end, we identify values that contribute to different interpretations of sustainability and provide a coherent account of that set of values (Table D.1).

Sustainability could be seen as the process of preserving the status of nature and leaving it no worse than we found it: the value we relate to this notion is *environmental friendliness*. Another interpretation is to perceive of sustainability as protecting public safety and security or, as defined by NEA<sup>8</sup>, as providing "the same degree of protection" for people living now and in the future. The IAEA<sup>9</sup> articulates these concerns in its Safety Principles when it states that nuclear waste should be managed in such a way that "predicted impacts on the health of future generations will not be greater than relevant levels of impact that are acceptable today." The value we link to these concerns is *public safety*, which pertains to the exposure of the human body to radiation and the subsequent health effects of radiation.

"[T]he same degree of protection", alluded to by NEA not only refers to the health and safety of people, but also to security concerns such as the unauthorized possession or theft of radioactive material to either cause sabotage or be used in the creation of nuclear weapons; *security* is the next value that will be addressed in this analysis. In the IAEA's Safety Glossary sabotage is defined as "any deliberate act directed against a nuclear facility or nuclear material in use, storage or transport which could endanger the health and safety of the public or the environment".<sup>10</sup> One can argue that 'security' as defined here also refers to the safety



considerations discussed above. We shall, however, keep the value of ‘security’ separate in this analysis so as to be able to distinguish between unintentional and intentional harm; the latter also relates to extremely relevant proliferation considerations such as the use and dispersal of nuclear technology for destructive purposes. We define ‘security’ as the protecting of people from the intentional harmful effects of ionizing radiation resulting from sabotage or proliferation.

So far we have presented three values for sustaining the environment and humankind’s safety and security. In other words, the right side of Figure D.1 represents the sustaining of the life of human and non-human animals as well as the status of nature. The other dimensions of sustainability link up with the sustaining of human welfare; some economists<sup>11</sup> state that “a development is sustainable if total welfare does not decline along the path” and that “achieving sustainable development necessarily entails creating and maintaining wealth”. We argue that sustaining welfare as a minimum requirement relates to the availability of energy resources which is why we distinguish between the three values of: 1) *resource durability*, 2) *economic viability* and 3) *technological applicability*. These three values are presented as moral values since they gain relevance in relation to each other and in aggregate they contribute to human welfare in terms of sustaining the resources.

*Resource durability* has to do with the availability of natural resources for the future. Brian Barry<sup>12</sup> presents the theory of intergenerational justice as the appropriate consumption of non-renewable natural resources across time. In relation to non-renewable resources “[L]ater generations should be left no worse off [...] than they would have been without depletion”. Barry proposes compensatory action or recompense for depleted natural resources. . Edward Page<sup>13</sup> suggests that the most obvious example of such compensation lies in technological improvement such as in heightened energy efficiency. Following this line of reasoning, we argue that technological progress could also lead to energy efficiency or to the deployment of new natural resources for energy production. We therefore present here *technological applicability* as one of the interpretations of the sustainability, defined as the *scientific feasibility* of a certain technology in combination with its *industrial availability*. Particularly industrial availability depends very much upon *economic viability* and competitiveness with respect to the alternatives.

**Table D.1 Values to Be Considered**

VALUE	EXPLANATION
Environmental friendliness	Preserving the status of nature Leaving it no worse than we found it
Public safety	Protecting people from the accidental and unintentional harmful effects of ionizing radiation
Security	Protecting people from the intentional harmful effects of ionizing radiation arising from sabotage or proliferation
Resource durability	The availability of natural resources for the future or the providing of an equivalent alternative for the same function
Economic viability	Embarking on a new technology at a certain stage and ensuring its continuation over the course of time
Technological applicability	The scientific feasibility of a certain technology as well as its industrial availability

## INTERGENERATIONAL ASSESSMENTS OF FUEL CYCLES

We shall continue in this section by looking at different nuclear power fuel cycles and the impacts that each fuel cycle has on different generations.

### Current practice: the once-through cycle

In a once-through fuel cycle (Figure D.2) enriched uranium is irradiated once in an LWR and spent fuel is kept in interim storage above-ground for a few decades, pending final disposal in deep geological repositories.

Figure D.2 Current Practice Consequences

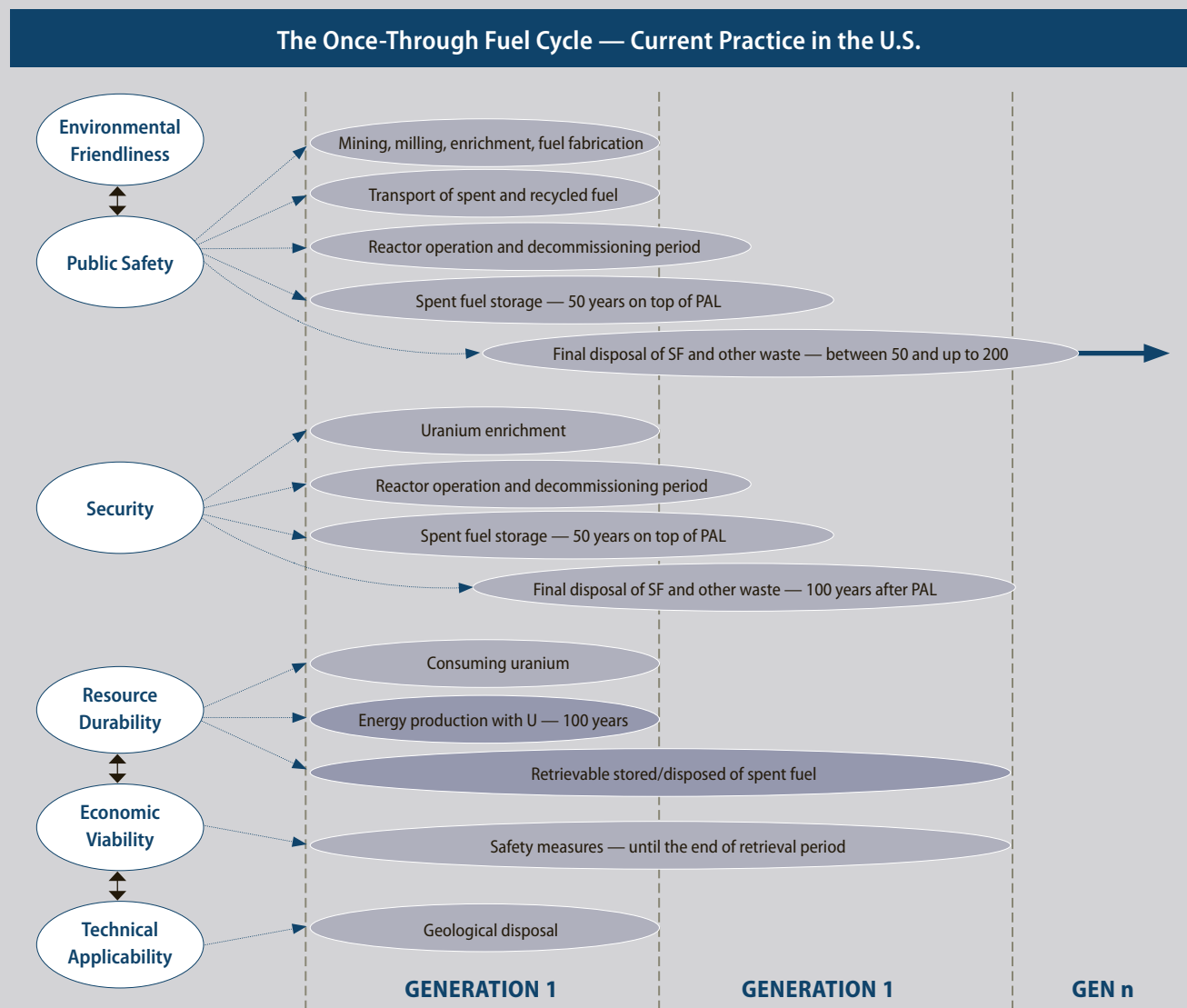

Note: Light and dark gray ellipses represent the respective burdens and benefits

In our analysis we make the explicit assumption that nuclear power will remain in use for a period of one hundred years; we call this period the *Period in which the Activity Lasts* (PAL). Some concerns continue for the duration of the PAL, for instance the safety concerns surrounding the front-end of the open fuel cycle related to the mining, milling, enrichment and fuel fabrication processes. Other concerns outlive the activity period like, for example, the power plant's decommissioning and its safety and security considerations. Finally, with some activities, the period of concern starts at a later stage and ends at a time that is independent of the PAL. For instance, the spent fuel derived from a once-through fuel cycle must be disposed of underground a few decades after the operation has started and concerns will last for the period of its radiotoxicity or its waste lifetime (200,000 years).

The lengths of the ellipses given in Figure D.2 are not intended to correspond to the actual durations of these periods; they merely serve to hint at the relative difference. A horizontal black arrow, like for instance the one given in front of the public safety concerns linked to final disposal, depicts a projection of these considerations extending into the future and far beyond the time frame of the charts. We can distinguish in our figures between two types of ellipses: the light-grey ones and the dark-grey ones representing all the respective burdens and benefits.

We also distinguish between generation 1 (Gen. 1) and generations 2 and beyond (Gen. 2-n). On the basis of the most recent estimations (Chapter 3), there will be enough reasonably priced uranium available this century in terms of once-through fuel cycle usage; the benefits of uranium deployment for Gen. 1 are illustrated by means of the dark-grey ellipse given in front of the resource durability indications. We immediately see here the problem of fairness that arises between Gen. 1 that benefits from the energy production while bearing some of the burdens and future generations that will mainly bear the safety and security burdens accompanying long-term nuclear waste disposal.

There is an interesting trade-off regarding the retrievability of spent fuel. Retrievable spent fuel is designed to give future generations an equal opportunity to benefit from the potential energy advantages underlying fissionable materials in spent fuel,<sup>14</sup> but at the same it causes additional safety and security concerns during the same period. In other words, in order to respect a next generation's freedom of action to use spent fuel for energy purposes, we need to impose more safety and security burdens on that generation.

### **Once-through cycle with direct underground storage/disposal**

In this fuel cycle spent fuel will be quickly stored underground in facilities that could be used both for storage and disposal purposes. This fuel cycle is a derivative of the first fuel cycle in that instead of the repository closing when full it remains open as a long-term storage facility so that the next generation can determine whether the resources preserved in the form of spent fuel are used for energy production or not. In this way the next generation's freedom of action is simultaneously safeguarded.

This cycle considerably reduces security concerns for Gen. 1 as SF is stored directly, however, it increases the transport risks because radioactive (and hot) SF must thus be directly transported to the storage/disposal facility. If Gen. 2 decides to leave SF (because it has no economic value) the very long-term safety concerns will remain unchanged. The alterations with respect to the *conventional* once-through fuel cycle are indicated by means of the red arrows pointing up and down with respect to increasing and decreasing burdens and benefits in Figure D.3.

Figure D.3 Direct Disposal Consequences

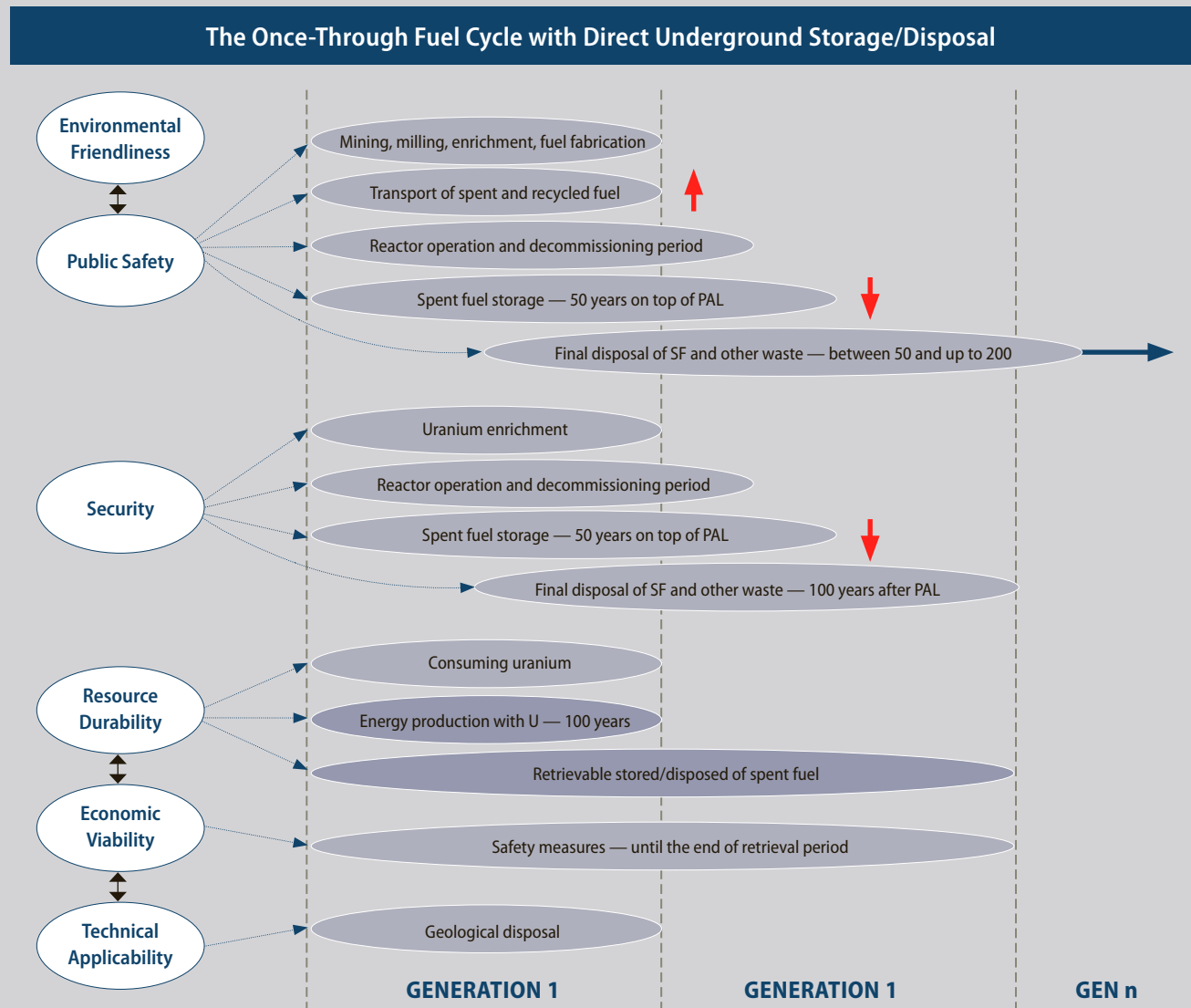

Note: The Elements Indicated in Red Represent the Divergences from Current Practice in the U.S. as Illustrated in Fig. 2.

### Transmutation of actinides: LWR-FR

In some countries (such as France and Great-Britain), SF is currently recycled in order to extract uranium and plutonium for reuse in LWRs and to reduce the waste lifetime. It is, however, a method that has received widespread criticism because of the proliferation risks attached to separating plutonium. A future possibility, to retain the advantages of recycling but to reduce security burdens, would be to develop an integrated fuel cycle that extracts uranium as fuel and consumes plutonium, together with minor actinides, in fast reactors. This fuel cycle *Partitions & Transmutes* (P&T) fission products and actinides. Before this type of fuel cycle can be deployed at industrial level it needs to be technologically refined and it must be economically viable.

The additional economic, safety and security burdens attached to developing the required technology and building the necessary extra facilities (i.e. reprocessing facilities and fast reactors) will mainly be borne by Gen. 1. This approach is capable of substantially reducing the long-term concerns for Gen. 2-n, as the long-lived actinides will be fissioned (or transmuted) in fast reactors. In our further analysis we refer to this fuel cycle as the LWR-FR (transmuter). In Figure D.4, the P&T approach is assessed and the differences when compared to the once-through cycle are highlighted in red.

**Figure D.4 Transmutation Consequences**

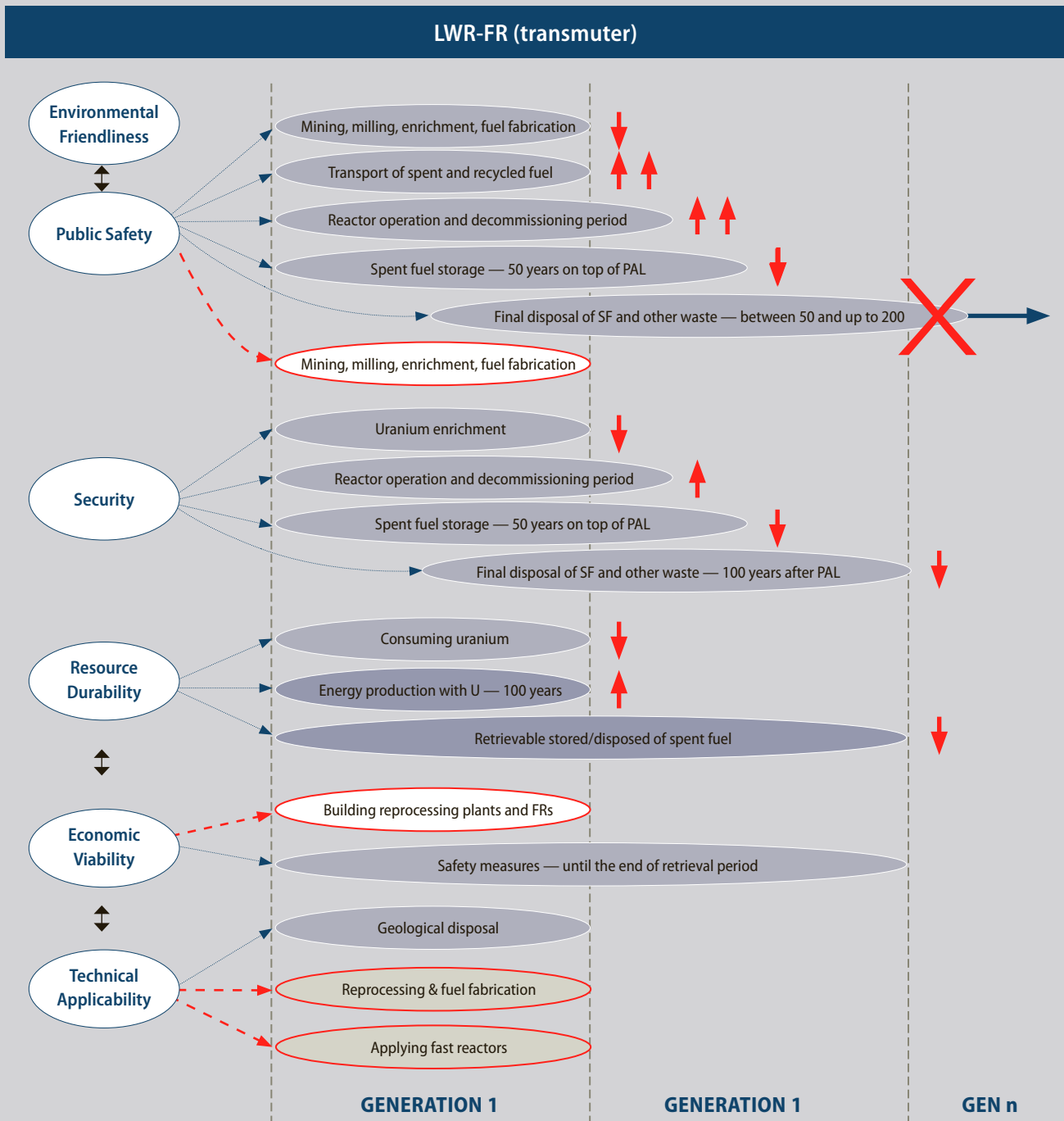

Note: The elements indicated in red represent the divergence from current practice in the U.S. as illustrated in Fig. 2.

## LWR-FR, the breeder configuration

The last fuel cycle is one in which fast reactors are used in the breeder configuration to breed (or make) more fuel than they consume. As breeders are capable of using uranium much more efficiently than LWRs, the period of resource durability and the potential benefits of resources<sup>15</sup> rise to thousands of years. On the other hand, these future benefits bring about more current burdens in terms of the technological challenges attached to developing such fuel cycles, the economic burdens arising from the additional investments that need to be made in R&D and the building of additional facilities as well as all the further safety and security concerns. To conclude, Gen. 1 will ultimately bear significant safety, security and economic burdens for future generations while facilitating adequate energy supplies and minimizing the long-term waste problems. In Figure D.5 this breeder fuel cycle is assessed and compared with the once-through fuel cycle. The dark-grey ellipse outlined in red indicates the long-term benefits of resource durability.

The type of concerns behind the transmutation approach and this type of fuel cycle (the breeders) are similar, but all these concerns increase when fast reactors enter into the breeder configuration formula. There are two reasons for this: 1) the breeder fuel cycle system is based on the notion that eventually all the LWRs will be phased out and the whole energy production process will be based on breeders (and on the multiple recycling of waste), which will involve building more fast reactors and, thus, creating more economic burdens for this generation and 2) this fuel cycle is primarily based on plutonium, which gives rise to further security concerns.

## COMPARING FUEL CYCLES

If we merge the alternatives into an impact table, we can evaluate the four cycles according to the proposed value criteria (expressed in terms of impacts); the alternatives are compared solely on the basis of a qualitative assessment of the single value criteria. High, medium and Low are chosen as the ranking designations. The scorecard is completed by adding the three traffic light colors to denote the ranking of the alternatives according to one single value criterion. Red stands for the most unfavorable option, green for the most favorable and amber indicates that either there is barely a difference between the alternatives, or the consequences are intermediate,<sup>16</sup> see in this connection the scorecard given in Table D.5. When assessing burdens, high impacts are unfavorable and thus colored red while amber and green are used consecutively. When benefits are rated (such as the benefits of energy production) high impacts are colored green.

Figure D.5 Breeder Consequences

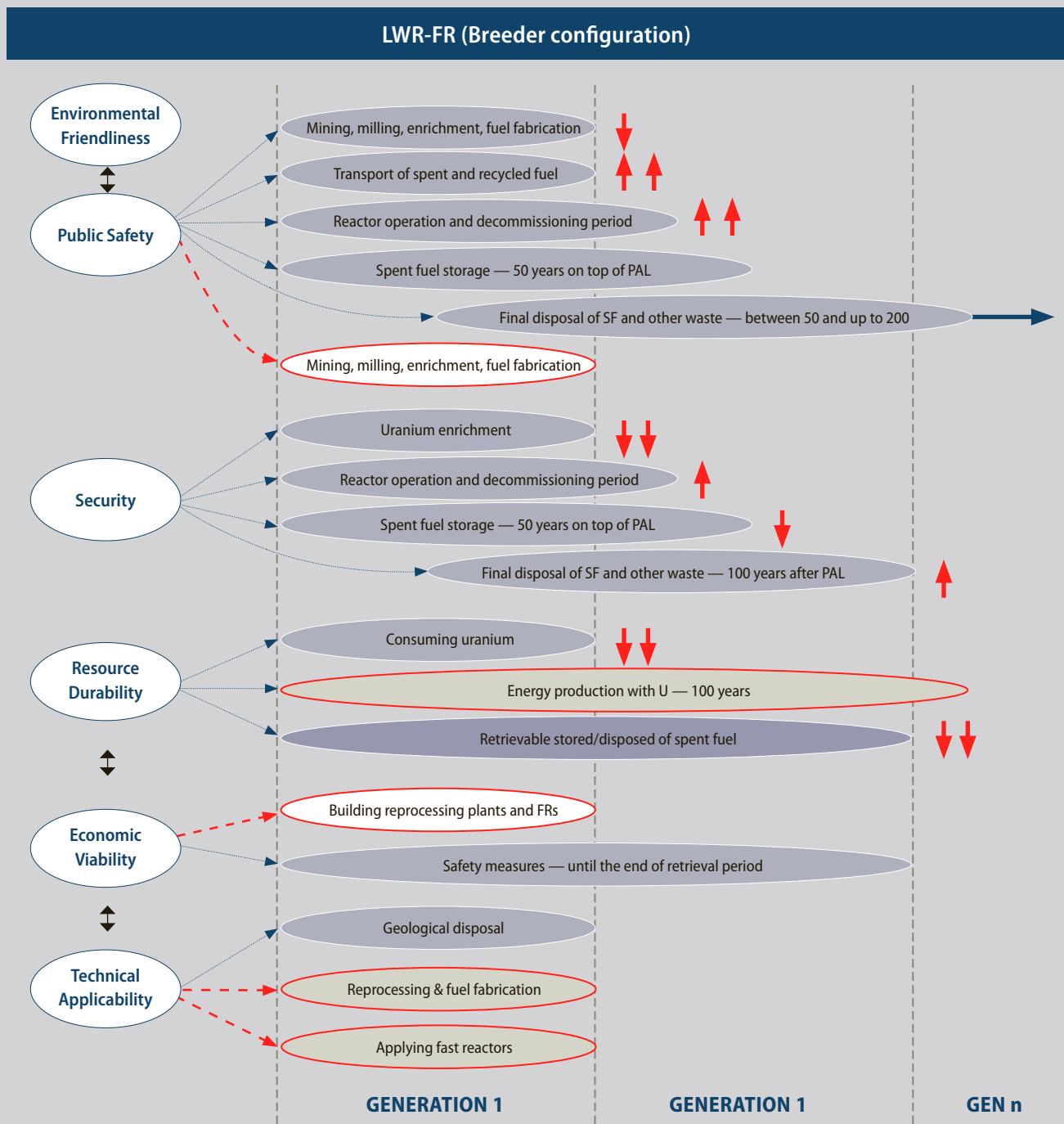

Note: The elements indicated in red represent the divergences from current practice in the U.S. as illustrated in Fig. 2.

**Table D.2 Scorecard and Explanation of Impacts and Rankings**

IMPACTS	ALTERNATIVES							
	CURRENT PRACTICE		DIRECT STORAGE		TRANSMUTER		LWR-FR (BREEDER)	
	Gen 1	Gen 2-n	Gen 1	Gen 2-n	Gen 1	Gen 2-n	Gen 1	Gen 2-n
<b>Environmental Friendliness/Public Safety</b>								
Mining, milling, enrichment, fuel fabrication	High		High		Medium		Low	
Transport of spent and recycled fuel	Low		Medium		High		High	
Reactor operation and decommissioning period	Low	Low	Low	Low	High	High	High	High
Spent fuel storage	High	High	Low	Low	High	High	High	High
Final disposal of spent fuel and other waste	Indifferent	High	Indifferent	High	Indifferent	Low	Indifferent	High
Reprocessing – applying fast reactors	×		×		Indifferent		Indifferent	
<b>Security</b>								
Uranium enrichment	High		High		Medium		Low	
Reactor operation and decommissioning period	Low	Low	Low	Low	High	High	High	High
Spent fuel storage	Medium	Medium	Low	Low	Low	Low	High	High
Final disposal of spent fuel and other waste	Medium	Medium	Medium	Medium	Low	Low	High	High
Reprocessing – applying fast reactors	×		×		Medium		High	
<b>Resource Durability</b>								
Consuming uranium	High		High		Medium		Low	
Energy production with uranium (benefit)	Low	Low	Low	Low	Medium	Medium	High	High
Retrievable stored/ disposed of spent fuel (benefit)	High	High	High	High	Medium	Medium	Low	Low
<b>Economic Viability</b>								
Safety measures costs until the end of retrieval	Indifferent	Indifferent	Indifferent	Indifferent	Indifferent	Indifferent	Indifferent	Indifferent
Building reprocessing plants and fast reactors	×		×		Medium		High	
<b>Technological Applicability</b>								
Geological disposal	Indifferent		Indifferent		Indifferent		Indifferent	
Applying reprocessing and fuel fabrication	×		×		High		High	
Applying fast reactors	×		×		High		High	

**Legend**

- Least Favorable
- Intermediate/Indifferent
- Most Favorable

The explanation of the rankings for Scorecard is provided below:

**Environmental friendliness/public safety**

*Mining, milling, enrichment, fuel fabrication*

The two first alternatives are based on enriching uranium and they involve the highest risk in this category. Breeders need no enriched uranium and they therefore carry the lowest risk (Alt. 4). The transmuter alternative (3) is based on transmuting the actinides in SF that come out of a LWR; Alt. 3 then involves less risk than the first two and more than the breeder alternative.

*Transport of spent and recycled fuel*

In Alt. 1 there is no recycled fuel; SF is transported to interim storage and eventually to disposal facilities. In Alt. 2 there is no recycling either; however the transport risk is higher, as hot and more radioactive spent fuel that has just come out of the reactor is immediately transported to the underground storage



facilities. These concerns are the highest for the two last alternatives in this category, since recycling involves more transportation in the form of recycled fuel returning to the reactor for irradiation.

#### *Reactor operation and decommissioning period*

There is a difference between the first two alternatives that solely use LWR and the last two that are based on FRs. The latter are generally sodium-cooled reactors that are thought to be relatively more difficult to decommission due to their greater complexity.

#### *Spent fuel storage*

In the last two alternatives that use sodium-cooled FRs it is difficult to store SF, as we need to manage sodium which needs to be stored under an inert cover gas. Alt. 1 stores SF above-ground and that also involves higher relative health risks. Once SF in Alt. 2 is put underground, the safety impacts are reduced.

#### *Final disposal of spent fuel and other waste*

With the first generation there is no difference between the concerns related to final disposal. The designation 'indifferent' for first generation waste should not however be read as 'no concerns', but the concerns remain fairly similar and cannot be ranked internally. The difference applies to generations 2 and beyond in which Alt. 3 scores the lowest, as long-lived actinides are transmuted. Three other alternatives contain long-lived actinides that require isolation from the atmosphere for a very long time.

#### *Reprocessing and applying fast reactors*

The two first alternatives solely use LWR and do not involve reprocessing; therefore there is no such risk involved. The two last alternatives involve some but more or less the same safety concerns.

## **Security**

#### *Uranium enrichment*

There is no difference between the two first alternatives, as the need for enriched U is the same. In Alt. 3, less enriched U is needed, as the transmuting of actinides also generates energy; Alt.3 therefore involves medium security concerns. Alt. 4 requires the lowest amount of enriched uranium, as this fuel cycle is based on Pu.

#### *The reactor operation and decommissioning period:*

Alts. 1 & 2 are the most favorable ones, as there is no separated Pu involved during operation; LWR work either on enriched U or Mixed Oxide fuel (MOX). Fast reactors (Alts. 3 & 4) are the least favorable due to the presence of Pu.

#### *Spent fuel storage*

Alt. 4 is the least favorable option, as it involves Pu. The best option is Alt. 3 as it gets rid of all the actinides (including Pu). Alt. 2 involves less security risks as after irradiation the SF is immediately placed underground in physically difficult to reach places. Strictly speaking, there is a difference between the types of risk related to Alts. 2 & 3, but for the sake of clarity we regard these two options as equal. In Alt. 1 we keep Pu in interim storage and therefore it scores worse than Alts. 2 & 3.

#### *Final disposal of spent fuel and other waste:*

Alt. 3 is the best option as the actinides are removed and transmuted. The two first alternatives score lower as they use enriched uranium and make Pu in the cycle. The worst option is the last one, because it is a pure Pu cycle; in the waste stream of a breeder reactor, there are still Pu isotopes that need to be disposed of.

#### *Reprocessing and applying fast reactors*

The two first alternatives solely use LWR and do not involve reprocessing; therefore there is no such security risk involved. Alt. 4 is based on the reprocessing of Pu so that it can be reused a couple of times, all of which involves the highest security burdens. In Alt. 3 actinides (including Pu) are reprocessed and transmuted in FRs; however the security concerns are lower than with Alt. 4.

### **Resource durability**

#### *Consuming uranium (as a burden)*

In the two first alternatives we use the highest amount of U as there is no recycling (reusing) involved. Alt. 3 scores lower in terms of burdens. Energy is produced when actinides are transmuted which therefore means that we use less U. Alt. 4 uses the lowest amount of U as it is a Pu cycle.

#### *Energy production with uranium (as a benefit)*

In terms of the benefits of energy production, applying breeders (Alt. 4) is the best option for this and the next generation, as that creates more fuel (Pu) that it consumes. Alt. 3 has fewer benefits as it still involves the use of U and the transmuting of actinides in SF. The first two alternatives have the lowest benefit as they consume most U. As we are indicating here benefits, 'high' (benefit) becomes the most favorable option and it is colored green.

#### *Retrievable stored and disposed of spent fuel (as a benefit)*

This row involves the potential benefits of retrieving spent fuel (or waste) and reusing fissile materials as *fresh* fuel. In the two first alternatives, there is still U and Pu present that could potentially be separated and reused. The transmuter cycle (Alt. 3) is based on the transmuting of actinides, but other actinides are produced during this process which are fissile and could also be used as fuel. Breeders use up all the Pu. As we are indicating here benefits, 'high' (benefit) is the most favorable option and it is colored green etc.

### **Economic viability**

#### *Safety measures costs until the end of the retrieval period*

There is no difference between the four alternatives to keep SF safe before the final disposal phase. Even when we immediately put SF underground (Alt. 2), certain costs need to be incurred for monitoring and keeping it retrievable. We assume that these costs will be equal for the four alternatives.

#### *Building reprocessing plants and fast reactors*

The two first alternatives solely use LWR and do not involve reprocessing; therefore there is no such risk involved. Alt. 3 involves building reprocessing plants and fast reactors, all of which is very costly. Alt. 4 is economically speaking the worst option as inevitably all LWRs will need to be replaced by FRs.

## Technological applicability

### *Geological disposal*

It is the same for all four alternatives. Even though the design criteria for different disposal facilities differ the technological challenges remain the same.

### *Applying reprocessing and fuel fabrication*

The two first alternatives solely use LWR and do not involve reprocessing; therefore there is no such risk involved. In the case of the last two the technological challenges are significant. Even though breeder fuel has already been generated (unlike actinide fuel for transmuters as in Alt. 3), there is still a technological challenge in Alt. 4 to fabricate fuel from recycled *breeder spent fuel*; most breeder fuel has not so far been recycled. The technological challenges for Alts. 3 & 4 are ranked equally, which means that they could have been denoted as 'indifferent'. By ranking them as 'high' we aim to emphasize that these are challenges that need to be dealt with.

### *Applying fast reactors*

The two first alternatives solely use LWR and do not involve reprocessing; therefore there is no such challenge. The technological challenges attached to applying fast reactors in the last two alternatives remain the same. As with the last impact, the technological challenges for Alts. 3 & 4 are ranked equally, which means that we could have termed them 'indifferent'. By ranking them as 'high' we aim to emphasize that these are serious challenges that need to be dealt with.

---

To emphasize the intergenerational considerations (as shown in the burden/benefit charts of the last section), the scorecard distinguishes between generation 1 and the subsequent generations. When choosing one alternative, two types of comparisons can be made: 1) the impacts for the first generations indicated by the *brightly* colored cells and 2) the impacts on future generations, indicated by the *shaded* cells. When two different alternatives score *the best* for different generations; the conflict arising from choosing the alternative should be regarded as a matter of intergenerational equity. The scorecard gives the decision maker a general appreciation of the tradeoffs between and within generations that need to be made.

As numerous incommensurable value criteria are still involved, the scorecard is not helpful for choosing the final fuel cycle alternative based on numerical ranking. However it can help the decision maker to understand a certain choice by providing information about the implicit trade-offs that this choice involves. In other words, the scorecard clarifies *at what societal expense* a choice is made and what burdens it will incur upon different generations.

Let us illustrate this by giving an example. Suppose that the decision maker decides to continue the current practice (Alt. 1). Based on the central values<sup>17</sup> of 'public safety' and 'security', this alternative scores relatively well; the short-term safety burdens of spent fuel storage and the long-term safety burdens of final disposal for Gen. 2 and beyond are then implicitly accepted as a consequence of this choice. As this alternative involves applying existing technology (with many fewer technological challenges) it scores well for 'technological applicability' when compared with other alternatives. For this and other reasons, the alternative brings about less economic concern. Alt. 1 furthermore scores badly in terms of 'resource durability', as the less abundant isotope of uranium (<sup>235</sup>U) is used once only in a reactor as fuel; reasonably priced uranium for this fuel cycle is assumed for a century.

What is lacking in this scorecard is a priority ranking of the values collected on this table. This priority ranking will depend largely on the value system of the decision maker and the society at the time. Will the decision maker value resource preservation more than cost or security? This is why such a scorecard can only highlight issues and not make the decision.

Let us also briefly consider a choice for Alt. 3 (the transmuter option) that is designed to eliminate as much as possible (long-lived) radioactive material in spent fuel. This alternative is based on utilizing fast reactors in transmuter configurations and reprocessing. The latter brings about greater safety and security concerns as reprocessing involves the separating of plutonium. The fast reactors (and their fuels) also need to be further developed, which imposes technological challenges as well as economic burdens on the present generation.

While the ratings for each of the categories of the Table D.2 may be subject to some disagreement, the process for establishing the color coding should be the subject of expert solicitation and consensus in a deliberative process. This process can be used to clarify positions on key questions which should assist the decision maker and enhance the transparency of the decision. In studying the Table one can develop an appreciation of the generational benefits and burdens in the final assessment of the best course of action based on intergenerational equity principles.

## CONCLUSION

In this analysis we have presented a method that provides insight into future fuel cycle alternatives by clarifying the complexity of choosing an appropriate fuel cycle in the context of the distribution of burdens and benefits between generations. The current nuclear power deployment practices, together with three future fuel cycles were assessed.

The key questions that should ultimately be answered prior to finally opting for a particular alternative are these. Should Gen. 1 accept significant safety, security and economic burdens for the benefit of future generations, thus in that way facilitating extended energy supplies (as proposed in Alt. 4) or minimizing the long-term waste problems (as outlined in Alt. 3)?

If the current analysis of the long term risk of a nuclear waste repository is correct in concluding that the risks and burdens of geological repositories to future generations are very low<sup>18</sup>, how can one justify placing a burden to the present generation to minimize future risk further by reprocessing and transmutation? To what extent is the transferring of risk to the very distant future acceptable? How and under what conditions could this generation consent to risks being imposed on future (still to be born) people? These are not easy questions to answer but this method illuminates the choices that need to be made in an informed manner.

How these questions should be dealt with and how the proposed value criteria that will lead to the choosing of one fuel cycle will be ranked, are matters that are beyond the scope of this analysis. We have compared four fuel cycle alternatives on the basis of single values that we derived from the overarching value of sustainability. We have also clarified the implicit trade-offs that decision makers make when they choose a certain alternative. In choosing a fuel cycle what must be evaluated are the societal costs and burdens accepted for each generation and how are these factors justified.

It must be noted, that net risks and benefits are partly dependent upon the available technologies, pointing to an intergenerational benefit of preserving options.

## CITATIONS AND NOTES

1. Taebi, B. and A. C. Kadak. 2010. "Intergenerational Considerations Affecting the Future of Nuclear Power: Equity as a Framework for Assessing Fuel Cycles". *Risk Analysis* 30 (9): 1341-1362.
2. B. Taebi, *Nuclear Power and Justice Between Generations – A Moral Analysis of Fuel Cycles*, Delft University, Netherlands, Simon Stevin Series in the Ethics of Technology, ISBN 978-90-386-2274-3, 2010.
3. Brundlandt, G.H., Our Common Future. Report of the World Commission on Sustainable Development. UN, Geneva, 1987; 208.
4. Dower, N., Global Economy, Justice and Sustainability. *Ethical Theory and Moral Practice*, 2004; 7(4): 399-415
5. Gardiner, S.M., The Pure Intergenerational Problem. *The Monist*, 2003; 86(3): 481-501.
6. Stevens, G., Nuclear energy and sustainability. Sustainable Development: OECD Policy Approaches for the 21st Century. Paris Nuclear Energy Agency, Organization for Economic Co-operation and Development, 1997.
7. Greenpeace, Nuclear Power, Unsustainable, Uneconomic, Dirty and Dangerous, A Position Paper, in UN Energy for Sustainable Development, Commission on Sustainable Development CSD-14, . 2006: New York.
8. NEA-OECD. Long-term Radiation Protection Objectives for Radioactive Waste Disposal, Report of a group of experts jointly sponsored by the Radioactive Waste Management Committee and the Committee on Radiation Protection and Public Health. Paris: Nuclear Energy Agency, Organization for Economic Co-operation and Development, 1984.
9. IAEA. The principles of radioactive waste management. Radioactive waste safety standards programme. (RADWASS) Safety Series 111-F. Vienna: IAEA, 1995.
10. IAEA. IAEA Safety Glossary, Terminology Used in Nuclear Safety and Radiation Protection Vienna: IAEA, 2007.
11. Hamilton, K., Sustaining Economic Welfare: Estimating Changes in Total and Per Capita Wealth. *Environment, Development and Sustainability* 2003; 5(3): 419-436.
12. Barry, B., The Ethics of Resource Depletion. In B. Barry, (ed). *Democracy, Power and Justice, Essays in Political Theory*. Oxford Clarendon Press, 1989.
13. Page, E., Intergenerational Justice and Climate Change. *Political Studies*, 1999; 47(1)
14. Besides the matter of future economic value, retrievability has other purposes too; the two most important ones are 1) to be able to take remedial action if the repository does not perform as expected and 2) to give future generations the possibility to render waste harmless with new technology.
15. If this benefit is to be enjoyed by future generations, we need to abandon the assumption that nuclear fission deployment will continue for 100 years. It seems fair, however, to make allowances for this as a *potential* future benefit.
16. Using the color green could be misleading as we are talking about a form of energy production. In choosing these colors we follow the relevant literature in policy analysis and comparable studies. The colors as applied in this analysis merely facilitate a comparison in a row without making any inference to other forms of energy
17. It should not be forgotten that for ease of analysis 'public safety' is merged with 'environmental friendliness'
18. NRC. Yucca Mountain Repository License Application for Construction Authorization, Safety Analysis Report. U.S. Nuclear Regulatory Commission, 2008.

# Appendix E — Status of Fuel Cycle Technologies

The existing fuel cycle technology reflects historical fuel cycle goals and the technology available at the time. From the 1960s through the early 70's, the expectations for nuclear power growth were high and uranium resources were thought to be extremely limited which resulted in (1) the assumption that the LWR technology was a transition technology because of inefficient use of uranium, (2) LWR SNF would be reprocessed and recycled back into LWRs for a limited time, and (3) there would be a rapid transition to a closed fuel cycle where all SNF would be reprocessed and recycled into high-conversion-ratio sodium-cooled fast reactors. LWR SNF pools at reactor sites were designed to store inventories of SNF for a few years before being sent to reprocessing facilities to recovery the fissile materials for reuse. Later in the decade, concerns regarding proliferation surfaced during the Ford/Carter era that resulted in a policy decision not to process SNF for recycle of plutonium, causing the abandonment of the Barnwell reprocessing plant for recovery of plutonium from LWR SNF. This decision was reinforced by economic factors (better LWR fuels, low uranium prices, higher-than-expected costs of SNF recycle, and high cost of fast reactors) that made once-through LWR fuel cycles more attractive. The LWR became the preferred reactor in most of the world. Slow growth in nuclear power stopped RD&D on fast reactors in the United States. The once-through LWR fuel cycle evolved as the U.S. reference fuel cycle technology.

## ONCE-THROUGH FUEL CYCLE TECHNOLOGY

The historical goals for improved once-through LWR fuel cycles have been driven by either improving short-term economics or nonproliferation characteristics of the fuel. The last major program was in the 1970s to increase the burnup of LWR fuel that improved economics (lower fuel fabrication costs, less frequent refueling of reactors, and less SNF for disposal) and improved nonproliferation characteristics (higher radiation levels associated with SNF and less plutonium per unit of energy produced). There has been limited work on more advanced LWR fuels (SiC clad, new fuel matrix materials) that could have major benefits in terms of reactor safety (larger safety margins) and waste management (better waste form)—but not the sustained effort required to commercialize a new fuel. There are several recent developments.

- ▣ *High-temperature reactor fuel.* In the last several years a reliable high-temperature reactor fuel has been developed—a major step toward developing a commercial high-temperature reactor that most likely will operate on a once-through fuel cycle.

- *Once-through fast reactor fuel.* There has been a significant interest in and initial development of a once-through sustainable fast reactor that after the initial core loading uses depleted uranium or natural uranium fuel (Appendix B). The viability of such advanced once-through fuel cycles is dependent upon successful development and demonstration of better fuel cladding materials.

## CLOSED FUEL CYCLE TECHNOLOGY

There are many closed fuel cycles with different goals, reactors, and fissile materials. The common characteristics of closed fuel cycles are a set of backend fuel-cycle operations where (1) SNF is physically and/or chemically separated into different product streams, (2) selected products are converted into new fuel assemblies or reactor targets, and (3) the wastes are converted into chemical and physical forms acceptable for disposal. Closed fuel cycles can accomplish four functions that can't be accomplished by open fuel cycles.

- *Purification and fissile concentration.* In a reactor fissile fuel is fissioned and fertile materials are converted to fissile fuel. The changing composition of the fuel (primarily buildup of fission products) may shut down the nuclear reactor. In reactors with conversion ratios less than 1, the fissile concentration decreases with time. Recycle separates fissile material to enable its recycle into new fuel and thus bypass reactor neutronics limits.
- *Fuel assembly replacement.* Radiation damages the fuel over time. A closed fuel cycle enables replacement of the clad and other components of the fuel. In many fast reactors, this is the primary purpose of a closed fuel cycle. Fissile material is produced as fast as it is consumed and the buildup of fission products does not shut down the reactor. In such closed fuel cycles the amount of SNF that is recycled (or even the need to recycle) is determined by clad materials properties; thus, better materials reduce the need for recycle.
- *Convert form of fuel.* If fuel is moved from one reactor type to another, the physical form of the fuel must be changed.
- *Waste management.* Some types of SNF are unacceptable for direct disposal and must be converted into acceptable waste forms. The need for SNF processing for waste management purposes is driven by SNF storage, transport, and disposal requirements.

In the LWR closed fuel cycle where plutonium is recycled to produce MOX fuel, the primary purposes of the closed fuel cycle are purification (removal of fission products) and increasing the concentration of the fissile material (plutonium) to enable fully utilizing the fuel and secondarily fuel assembly replacement. In many fast reactor systems with metallic fuel, the primary purpose of the closed fuel cycle is fuel assembly replacement and only secondarily purification—radiation damage to the fuel clad limits fuel lifetime. In a closed fuel cycle where LWR SNF is used to startup fast reactors, purification and conversion of the fuel form is required. Fast reactors require higher concentrations of fissile material than do LWRs and have different fuel forms. There are several cases where reprocessing is required for waste management purposes. In the 1950s the British built Magnox reactors for electricity and production of plutonium for weapons. The fuel is a uranium metal fuel in a magnesium-alloy clad that is chemically unstable in most environments. The SNF was originally processed to recover plutonium for weapons purposes but today is reprocessed to produce an acceptable waste form.

With few exceptions, the existing closed fuel cycle technologies require the separation of pure plutonium or plutonium/uranium mixtures from SNF before fabrication of new fuel because of technical and economic constraints in the production of new nuclear fuel assemblies. Nuclear fuel assemblies are highly engineered components that require extensive quality assurance. This is much easier to do this when starting with pure materials rather than with impure materials containing fission products with high radiation limits. In most cases separation of pure fissile materials such as plutonium is not a fundamental requirement of closed fuel cycles but rather a consequence of existing fuel fabrication technology limits.

Different closed fuel cycles have radically different types of reactors and fuels; however, the same backend fuel cycle technologies are used for separating different types of SNF into product streams and converting wastes into acceptable waste forms for disposal. This is because all SNF contains the same actinides and fission products with the same requirements for acceptable waste forms. In contrast, the fuel fabrication technology is fuel cycle and reactor specific.

A product slate is critical to the design, configuration, and operations of the separations and waste treatment units in a recycling plant. The product slate will depend on the SNF feed material, the selected recycling reactors (fast or thermal reactors), the recycle strategy (total or partial-closed cycle), fuel reactor fuel configurations (homogeneous or heterogeneous), type of recycled fuel (metal, oxides, other ceramics, etc.), as well as target materials/configuration. Ultimately, it is the recycle fuel fabrication and waste disposal methods that provide the specifications for what are the form and composition of the products coming out of a recycling plant.

## Separations and Waste Treatment

The larger the number of products desired from SNF, the more complex the recycling plant. A recycling plant incorporates separations to produce desired products and waste management facilities. Traditional functions encountered in recycling facilities are listed in Table E.1 for both aqueous and electrochemical (pyrochemical) processes.

- ▣ *Aqueous processing.* The fuel is dissolved in a low-temperature aqueous acid solution with various organic extractants used to separate products from the aqueous solution. The process can be scaled to very large sizes (7000 tons SNF/year)
- ▣ *Electrochemical (pyrochemical) processing.* The fuel is dissolved in a high-temperature salt with electrochemical methods used to “plate-out” metallic products. The process is usually operated as a batch process with multiple lines to meet throughput requirements.

Commercially only one type of recycling facility exists, that which recovers plutonium from LWR spent fuel for production of MOX fuel (recycle of plutonium back to LWRs). Three complete commercial recycling plants have been built which include the separations and waste treatment portions, but all lack treatment for selected off-gases and tritiated water:

- ▣ LaHague (France): 2 trains of 800 tons LWR SNF/year
- ▣ Sellafield THORP (Great Britain): 1200 tons LWR SNF/year
- ▣ Rokkasho (Japan): 800 tons LWR SNF/year

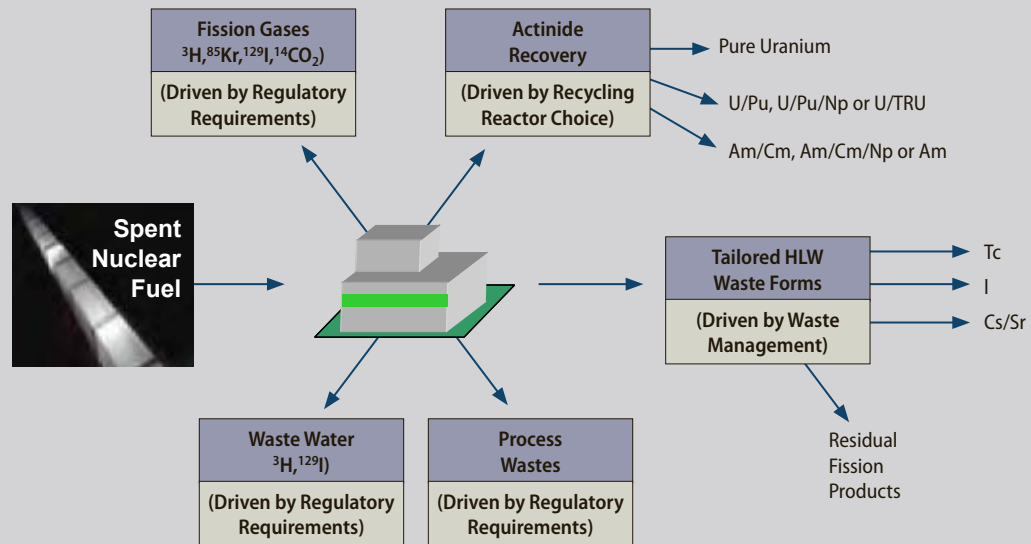

**Table E.1 Recycling Plant Functions**

AREA	AQUEOUS FACILITY FUNCTION	ELECTROCHEMICAL FACILITY
Receiving	Cask unloading, assembly inspection and storage	
Feed Preparation	Chopping, leaching and dissolution	Chopping, shredding and load into baskets
Gas Handling and Purification System	Capture gases from dissolver and process operations	Removes oxygen and water from inert cell atmosphere and collects fission gases
Separations	Recovery of variety of oxide products in solution	Recovery of metallic U and U/TRU product
Product Conversion	Solidification	Consolidation (melting)
Equipment Repair and Maintenance	Area for repair and maintenance of process and remote handling equipment	
Waste-form Production	Conversion to waste forms acceptable for repository disposal, typically glass, treatment and storage of secondary waste, which may include cladding, hardware, LLW, TRU, organics, process water, filters and failed equipment	Production and packaging of metallic waste form and non-metallic waste form(s) acceptable for repository disposal, treatment and storage of secondary waste, which may include hardware, filters and failed equipment
Storage Facilities	Facilities to manage waste previous to final disposal—including decay heat cooling of high-level waste before disposal	
Product Storage Facility	Interim storage of products	

For multi-objective fuel cycles, there may be incentives to separate a number of materials given their potential benefit as shown in Figure E.1 for LWR fuel. As more products are recovered, the need to use a variety of separation and product fabrication technologies increases. Examples of different recycling technologies and their development stages are shown in Table E.2 for metal and oxide fuels.

**Figure E.1 Potential Product and Waste Streams of LWR Fuel Recycling**



**Table E.2 SNF Recycling Technologies\***

FUEL COMPOSITION	TECHNOLOGY	TECHNOLOGY DESCRIPTION	TECHNOLOGY READINESS
U/Pu-MOX LWR	PUREX	Dilute Pu in LEU; Pu back-blended w/U Am and Cm build-up in spent MOX	Plant-scale
U/Pu-MOX FR	PUREX	LEU w/20+% Pu; Pu back-blended w/U Breeding possible	Plant-scale
U/Pu-Metal FR	Electrochem.	LEU w/20+% Pu; Pu never separated Breeding possible	Large Eng.-scale
U/Pu/Np-OX LWR	COEX UREX+2	Dilute Pu in LEU; Pu never separated $\gamma$ -radiation from Np Am and CM build-up in spent OX	Small Eng.-scale
U/Pu/Np-OX FR w/Am/Cm targets	UREX+3	LEU w/Np, w/20+% Pu; Pu never separated $\gamma$ -radiation from Np Targets have high $\gamma$ - and n-radiation fields Breeding possible	Small Eng.-scale
U/TRU-OX FR	UREX+1a Electrochem.	Pu ~90% of TRU; Back-blend U w/TRU, Pu never separated $\gamma$ - and n-radiation from MA Breeding possible	Small Eng.-scale
U/TRU-Metal FR	Electrochem. UREX+1a	Pu ~90% of TRU; Back-blend U w/TRU, Pu never separated $\gamma$ - and n-radiation from MA Breeding possible	Small Eng.-scale

\*Commercial reprocessing plants can process a variety of SNF types using the PUREX process. The product stream is purified plutonium oxide, uranium oxide, or a mixture of plutonium and uranium oxides. All other radionuclides go to waste processing.

The only commercial process is the Purex process, an aqueous process that can be easily scaled to very large plant sizes. In the context of separations, aqueous processes are more versatile because there are a very large number of organic extractants that can be used to extract specific actinides or fission products. COEX and UREX are other aqueous processes using different extractants.

### *Recycle Fuel Fabrication Facilities*

Fuel choices greatly impact the recycle fuel fabrication facility. *Existing technologies are only capable of fabricating fuels from mixtures of clean plutonium, uranium, and neptunium with low radiation levels.* Uranium oxide fuel fabrication relies on many manual steps (Figure E.2a) where minimum shielding is required. Traditional functions encountered in a fuel fabrication facility are listed in Table E.3 for traditional LWR UO<sub>2</sub> fuels. If there is a goal to recycle other nuclides back to reactors for either waste management or nonproliferation objectives, the commercial fabrication technology does not now exist. Unlike a separations recycling plant, where the knowledge of how to operate a fully remote operating facility with high radiation limits is known (canyons, dark cells, hot-cells), this knowledge has not been demonstrated for fuel fabrication facilities.

In a MOX fuel fabrication facility where a combination of uranium and plutonium oxides are mixed as fuel for LWRs, glovebox-type shielding (Figure E.2b) is added mainly to protect workers from ingestion of airborne alpha-emitting radionuclides, but the process itself is almost identical to the production of UO<sub>2</sub> fuels. For transmutation targets or minor actinide bearing fuels, which contain transuranic materials, fabrication must be done remotely due to the high gamma and neutron radiation fields in hot cells (Figure E.2c). Fabrication of TRU-OX fuels will require a new manufacturing process where reliance on manual operations is eliminated. To date only two technologies have been partly developed

**Table E.3 Conventional Fuel Fabrication Functions**

AREA	FUNCTION
Receiving	Unloading of UF <sub>6</sub> cylinders
UF <sub>6</sub> Vaporization/Oxide Conversion	Heating UF <sub>6</sub> solids to a gas which is chemically processed to form UO <sub>2</sub> powder
Powder grinding, pressing, sintering and pelletization	UO <sub>2</sub> is ground to a uniform mesh and pressed into pellets that are sintered into a ceramic form
Ceramic pellet quality check	Pellets are visually inspected
Fuel rod manufacturing	Ceramic pellets are stacked into a Zircaloy tube to form a rod
Fuel assembly manufacturing	Fuel rods are bundled into assemblies depending on reactor configuration
Storage Facilities	Assemblies are stored pending transfer to reactor facilities

that could minimize manual operations, sol-gel and Vibro-pack (vibrapac). Examples of different fuel fabrication technologies and their development status are shown in Table E.4.

No country has commercially implemented a fully closed fuel cycle. Any commercially successful partially closed or closed fuel cycle will require that the SNF scheduled for recycling be carefully chosen. For example, if one is to economically recycle in LWRs, there is a desire to maintain given uranium and plutonium isotopic ratios for the recycle fuel. This will limit the amount of current SNF that can be economically recycled in an LWR given that separations facilities do not separate isotopes but elements, which require that any desired isotopic ratio be managed by the selection of the SNF that is to be recycled. France has a partially closed fuel cycle and produces MOX fuel from plutonium recovered from LWR SNF, but the recycle SNF is carefully selected for similar burn-up and cooling time in order to simplify the process and make it more commercially attractive. Since France has a uniform reactor fleet, this strategy is readily implemented. The MOX SNF is not recycled because the plutonium isotopics of this SNF make it difficult to recycle in LWRs.

Conceptually, the recycle of fissile materials in a closed fuel cycle is similar to the recycle of scrap metal. To produce recycle steel, the steel recycle facility mixes different types of scrap in the proper ratios to meet the product specifications for the steel. Similarly, to recycle plu-

**Figure E.2 Fuel Fabrication Facilities**

(a) Fuel Rod Inspection, no shielding

(b) Glovebox Operation

(c) Hot Cell Operations

Figures courtesy of Argonne National Laboratory<sup>1</sup>.

**Table E.4 Recycling Fuel Fabrication Technologies**

FUEL COMPOSITION	FUEL FABRICATION TECHNOLOGY	FUEL PACKING	SHIELDING NEEDS	TECHNOLOGY READINESS
U/Pu-MOX LWR	Mill and mix U and Pu oxides. Cold press and sinter	Pellets stacked in cladding	Shielded glovebox with controlled atmosphere	Plant-scale
U/Pu-MOX FR	Mill and mix U and Pu oxides. Cold press and sinter	Pellets stacked in cladding	Shielded glovebox with controlled atmosphere	Plant-scale
U/Pu-Metal FR	Dip cast from molten-metal bath	Metal rod in cladding Na-bonded	Shielded glovebox with controlled atmosphere	Large Eng.-scale*
U/Pu/Np-OX LWR	Mill and mix oxides. Cold press and sinter	Pellets stacked in cladding	Shielded glovebox or cell with controlled atmosphere	Small Eng.- scale
U/Pu/Np-OX FR	Mill and mix oxides. Cold press and sinter	Pellets stacked in cladding	Shielded glovebox or cell with controlled atmosphere	Small Eng.- scale
U/TRU-OX FR	Precipitate oxides or precursors to form granular product	Product remotely packed in cladding	Shielded cell with controlled atmosphere	Small Eng.- scale
U/TRU-Metal FR	Dip cast from molten-metal bath	Metal rod in cladding Na-bonded	Shielded cell with controlled atmosphere	Small Lab-scale
U/Pu or TRU Ceramic	sol-gel** microsphere pelletization	Microspheres packed in cladding (plutonium-uranium solid-solution oxides, carbides, or nitrides)	Shielded glovebox/cell with controlled atmosphere	Lab-scale
U/Pu or TRU OX	Vibro-pack***	Ceramic pellets remotely packed	Shielded glovebox/cell with controlled atmosphere	Pilot-scale
Am/Cm targets	Precipitate oxides or precursors to form granular product	Product remotely packed in cladding	Shielded cell with controlled atmosphere	Lab-scale

\*Technology readiness is large engineering scale, but current process is not commercially viable due to waste generation and actinide losses  
 \*\*Sol-Gel2  
 \*\*\*Vibro-pack3

tonium (with each fuel assembly having different plutonium isotopics), different SNF fuel assemblies are processes as a group to obtain the desired end product.

**U.S. FUEL CYCLE**

In countries like the United States where the reactor fleet is far from uniform and the burn-up time and cooling time of the SNF inventory varies widely, the French commercial MOX strategy would be more difficult to implement for the current stock of SNF. If the U.S. is to achieve multi-objective fuel cycle goals, it is necessary to evaluate what is the preferred option that is applicable to the United States, for its current and future SNF inventory. In this context, there is a very large technical and economic difference between recycle of most SNF and all SNF. If economics are a major component of a decision to recycle SNF, the SNF with a high fissile assay will be recycled while SNF with a low fissile assay will be considered wastes. This is similar to the recycle of metals, paper, and other waste streams worldwide.

The last funded effort to address closing of the fuel cycle in the U.S. was led by the DOE Global Nuclear Energy Partnership (GNEP) program. It initially focused on R&D needs and small engineering-scale demonstration of advanced recycling technologies being developed as part of its R&D portfolio. Later, the GNEP strategy moved to deployment of full-scale commercial facilities which resulted in a Funding Opportunity Announcement to industry and funding of four cooperative agreements.<sup>4</sup> Industry provided deployment plans and conceptual designs for a nuclear fuel recycling center and an advanced recycling

reactor. A summary of inputs from industry are given in Table E.5. None of the options proposed by industry separated pure plutonium. The design capabilities specified by the FOA were:

- ▣ Separating LWR SNF into its reusable and waste components
- ▣ Reducing the volume, heat load and radiotoxicity of waste requiring geological repository disposal
- ▣ Generating electricity with an advanced reactor that consumes transuranic elements as part of the fuel

In 2008, DOE-NE issued a draft GNEP Programmatic Environmental Impact Statement (PEIS)<sup>5</sup> and a draft Nonproliferation Impact Assessment (NPIA)<sup>6</sup> to assess the potential impact of expanding nuclear power in the U.S. under six fuel cycle alternatives. In addition, the GAO<sup>7</sup> published an evaluation of the extent to which DOE would have addressed the GNEP's objectives under its original engineering approach and the accelerated approach to build full-scale facilities. GAO recommended that DOE reassess its preference for accelerating approaches to GNEP as using existing technologies may have resulted on lesser benefits than anticipated from advanced technologies in the areas of waste and non-proliferation. Also the NRC<sup>8</sup> published a white paper on issues related to regulating recycling facilities. The GNEP program was terminated in 2008 and replaced with a fuel cycle R&D program.

**Table E.5 Proposed Industry Deployment Plans <sup>9</sup>**

	<b>NUCLEAR FUEL RECYCLING CENTER</b>	<b>ADVANCED RECYCLING REACTOR</b>
International Nuclear Recycling Alliance (INRA)	<ul style="list-style-type: none"> <li>• COEX™ process (no pure Pu stream)</li> <li>• Flexible to allow deployment of new technology (MA actinide when mature)</li> <li>• Capacity based on market for recycle fuel (800-2500Mt/y)</li> </ul>	<ul style="list-style-type: none"> <li>• Re-use U/Pu initially as MOX in LWR and later in Sodium Fast Reactor (SFR)</li> <li>• R&amp;D required to make cost competitive and enhance reliability and safety               <ul style="list-style-type: none"> <li>– Based on technology from JOYO, MONJU, Phenix, SuperPhenix</li> </ul> </li> <li>• Start with oxide fuel but can use metal</li> </ul>
Energy Solutions	<ul style="list-style-type: none"> <li>• NUEX™ process (no pure Pu stream)</li> <li>• Deploys minor actinide separation technology</li> <li>• Capacity 1500MT/y</li> <li>• Co-location of separation and fuel fabrication</li> </ul>	<ul style="list-style-type: none"> <li>• Re-use recycle uranium in CANDU or LWRs</li> <li>• Re-use U/Pu initially as MOX and later U-TRU in Advanced Recycling Reactors</li> <li>• Option for Am/Cm for burning-transmutation in CANDU or LWR reactors</li> </ul>
GE/Hitachi	<ul style="list-style-type: none"> <li>• Electrometallurgical process (no pure Pu stream)</li> <li>• U/TRU product</li> <li>• Fuel cycle facility to support 3 power blocks of 622 MWe</li> <li>• Co-location of separation and fuel fabrication</li> </ul>	<ul style="list-style-type: none"> <li>• Re-use recycle uranium in CANDU</li> <li>• Re-use actinides in a PRISM Sodium Fast Reactor</li> </ul>
General Atomics	<ul style="list-style-type: none"> <li>• UREX+1a process (no pure Pu stream) for LWR recycle</li> <li>• Electrometallurgical process (no pure Pu stream) for high temperature gas-cooled reactor (HTGR) recycle</li> <li>• U/TRU product</li> <li>• Capacity 2000 MT/y</li> </ul>	<ul style="list-style-type: none"> <li>• Re-use LWR actinides in a deep-burn HTGR</li> <li>• Re-use deep-burn HTGR actinides in Advanced Recycling Reactors</li> </ul>

## CITATIONS AND NOTES

1. Managed and operated by UChicago Argonne, LLC, for the U.S. Department of Energy under Contract No. DE-AC02-06CH11357
2. Bischoff and Stratton. "Process for the production of ceramic plutonium-uranium nuclear fuel in the form of sintered pellets". United States 4231976. 1980
3. Based on technologies developed by RIAR (Research Institute of Atomic Reactors) in Russia "Trends in Nuclear Fuel Cycles Economic, Environmental and Social Aspects", Organization for Economic Co-operation and Development 2002, Chapter 4.
4. U.S. Department of Energy Press Release "Department of Energy Seeks to Invest up to \$15 Million in Funding for Nuclear Fuel Cycle Technology Research and Development" April 17, 2008
5. U.S. Department of Energy, "Draft GNEP Programmatic Environmental Impact Statement", DOE/EIS-0396 October 2008
6. U.S. Department of Energy, "Draft Nonproliferation Impact Assessment for the GNEP Programmatic Alternatives", NNSA, December 2008
7. U.S. General Accounting Office, "GNEP DOE Should Reassess Its Approach to Designing and Building Spent Fuel Recycling Facilities", GAO-08-483 Washington, D.C. April 2008
8. U.S. Nuclear Regulatory Commission "Background, Status, and Issues Related to the Regulation of Advanced Spent Nuclear Fuel Recycling Facilities", ACNW&M White Paper, June 2008, NUREG-1909
9. Nuclear Waste Technical Review Board, Presentations, June 11 and September 23, 2009 and "GNEP Deployment Studies: Executive Summary GA Project 30293", General Atomics, May 22, 2008, San Diego CA, PC-000555 Rev 2

this page intentionally left blank

this page intentionally left blank



this page intentionally left blank

Massachusetts Institute of Technology

ISBN 978-0-9828008-4-3  
PSB 11-01-0026