

## NASA Technical Paper 1225

LOAN COPY: RETURN  
AFWL TECHNICAL LIB  
KIRTLAND AFB, N:

0134467



# Nuclear Waste Disposal in Space

R. E. Burns, W. E. Causey,  
W. E. Galloway, and R. W. Nelson

MAY 1978

**NASA**







NASA Technical Paper 1225

# Nuclear Waste Disposal in Space

R. E. Burns, W. E. Causey,  
W. E. Galloway, and R. W. Nelson  
*George C. Marshall Space Flight Center*  
*Marshall Space Flight Center, Alabama*



National Aeronautics  
and Space Administration

**Scientific and Technical  
Information Office**

1978



## ACKNOWLEDGMENT

The authors wish to thank Wayne Deaton, Charles Guttman, J. Gregory DeField, William Bailey, Jack Loose, and Larry Lott for their contribution to this report.

Also, the personnel of Battelle, Inc., Northrop Services, Inc., and Science Applications, Inc., deserve recognition for their major contributions to the effort. Although not involved contracturally, personnel at Oak Ridge National Laboratory have provided critically needed information.



## TABLE OF CONTENTS

	Page
SUMMARY . . . . .	1
I. INTRODUCTION . . . . .	2
A. Reason for the Study . . . . .	2
B. Study Ground Rules . . . . .	3
C. Generation of Waste in Nuclear Reactors . . . . .	3
D. Character of High-Level Waste and the Need for Isolation . . . . .	6
E. Previous Studies . . . . .	6
F. Comparison of Space and Terrestrial Options . . . . .	7
II. POST-REACTOR PROCESSING . . . . .	8
A. Waste Projections . . . . .	8
B. General Discussion of Separation of Nuclear Waste Products . . . . .	8
C. Waste Mixes for Evaluation . . . . .	12
D. Definition of Required Level of Partitioning . . . . .	21
E. Waste Forms . . . . .	22
III. SPACE OPTIONS . . . . .	30
A. High Earth Orbit . . . . .	30
B. Lunar Orbit . . . . .	32
C. Lunar Soft Landing . . . . .	33
D. Solar Orbit . . . . .	38
E. Solar System Escape . . . . .	42
F. Solar Impact . . . . .	42
G. Space Option Comparison . . . . .	42
IV. NUCLEAR WASTE PACKAGING . . . . .	45
A. Waste Canister . . . . .	45
B. Radiation Shield . . . . .	50
C. Mechanical Containment . . . . .	54
D. Thermal Protection System . . . . .	61
E. Ejection System . . . . .	62
V. MISSION SCENARIO . . . . .	64



## TABLE OF CONTENTS (Concluded)

	Page
VI. GROUND OPERATIONS . . . . .	67
A. Transportation from Reprocessor to Receiving Facility at Launch Site . . . . .	67
B. Launch Site Selection . . . . .	68
C. Required Equipment and Facilities . . . . .	74
D. Comparison of Ground Operations for Space Disposal Versus Terrestrial Storage . . . . .	75
VII. SAFETY AND RELIABILITY REQUIREMENTS . . . . .	80
A. Ground Handling Safety Guidelines . . . . .	83
B. Flight Operations Safety Guideline . . . . .	85
C. Special Procedures/Requirements . . . . .	87
VIII. SPACE TRANSPORTATION SYSTEM REQUIREMENTS . . . . .	89
A. Space Shuttle and Required Modifications . . . . .	90
B. OTV Definition . . . . .	90
C. Reusable Versus Expendable OTV . . . . .	92
D. Shuttle Derived Heavy Lift Vehicles . . . . .	95
E. Traffic Analysis . . . . .	96
REFERENCES . . . . .	105



## LIST OF ILLUSTRATIONS

Figure	Title	Page
1.	Study options . . . . .	4
2.	U.S. nuclear power generating capacity GW(e). . . . .	9
3.	Waste generated by U.S. nuclear power industry . . . . .	10
4.	Thermal conductivity versus temperature for $\text{UO}_2$ cermet and their matrix metals . . . . .	27
5.	Space options . . . . .	31
6.	Flight profile for the lunar orbit mission . . . . .	36
7.	Perturbations produced by lunar and solar gravity on a highly eccentric immediate orbit . . . . .	37
8.	Long term variations in aphelion and perihelion . . . . .	39
9.	$\Delta V$ and period versus OTV burntime for 0.86 AU mission . . . . .	40
10.	Risk profile for solar orbit disposal with retrieval . . . . .	41
11.	$\Delta V$ and period versus OTV burntime for solar system escape mission . . . . .	43
12.	Hexagonal packaging configuration . . . . .	46
13.	Telescoping package configuration . . . . .	47
14.	Radial and orthogonal finning concepts . . . . .	48
15.	Nuclear waste maximum temperature versus angle between fins at various fin thicknesses . . . . .	49
16.	Typical shield for the cylindrical or hexagonal package . . . . .	53
17.	Typical shield for the hemispherical shield . . . . .	53
18.	Shield weight for 19 cylinder configuration . . . . .	55
19.	Neutron shielding effects . . . . .	56



## LIST OF ILLUSTRATIONS (Continued)

Figure	Title	Page
20.	Shield weight as a function of waste density . . . . .	57
21.	Shield weight for the different mixes (waste density = 4 gm/cm <sup>3</sup> ) . . . . .	58
22.	Orbiter/payload separation . . . . .	63
23.	Orbiter/payload separation . . . . .	63
24.	Orbiter/ET impact trace for ETR launch (yaw steering after SRB separation) . . . . .	69
25.	Orbiter/ET impact trace for Trindade launch . . . . .	70
26.	Remote operational base concept Trindade Island (Brazil) . . . . .	72
27.	Deorbit opportunities for Trindade launch . . . . .	73
28.	Deorbit opportunities for KSC launch . . . . .	73
29.	Nuclear payload flow . . . . .	77
30.	Cocoon flow . . . . .	78
31.	High Earth orbit mission event sequence window . . . . .	81
32.	Detailed task steps of mission event sequence . . . . .	82
33.	Total mission savings versus OTV ISP . . . . .	91
34.	Launch rates for LSL mission . . . . .	100
35.	Launch rates for the Class I STS-derived HLLV (Mix 3) . . . . .	101
36.	Launch rates for LSL mission (Mix 3) . . . . .	102
37.	Launch rates for Mix 3 . . . . .	103



## LIST OF TABLES

Table	Title	Page
1.	Properties of the Fission Products and Actinide Elements that Occur in the Waste Mixture . . . . .	13
2.	Thermal Density of Each Waste Mix . . . . .	20
3.	Oxides and Some of Their Properties . . . . .	25
4.	Description of Specimens Used for Physical-Property Measurements . . . . .	28
5.	Nuclear Waste Rendezvous Data . . . . .	34
6.	Photon Source Strength . . . . .	52
7.	Gamma Shield Material Requirements . . . . .	54
8.	ETR and Trindade Launch Site Considerations . . . . .	71
9.	Potential Accidents Involving Terrestrial Handling of Nuclear Waste for Space Disposal . . . . .	84
10.	Boost Vehicle Concepts . . . . .	89
11.	Upper Stage Concepts . . . . .	89
12.	Shuttle Weight Statement . . . . .	97
13.	Class I STS-Derived HLLV Weight Statement. . . . .	97
14.	Class II STS-Derived HLLV Weight Statement . . . . .	98
15.	Ballistic HLLV Weight Statement . . . . .	98
16.	Class II Winged HLLV Weight Statement . . . . .	99
17.	Total Number of Flights for Various Combinations . . . . .	99





## GLOSSARY

AEC	Atomic Energy Commission
AGNS	Allied General Nuclear Services
Calcine	Oxidized HLW
CSP	Cocoon-shield Package
Curie	$3.7 \times 10^{10}$ Disintegrations Per Second
DDT&E	Design, Development, Test, and Evaluation
DOT	Department of Transportation
EIS	Environmental Impact Statement
EML	Earth-Moon-Line
EPA	Environmental Protection Agency
ERDA	Energy Research and Development Administration
ET	External Tank
FACA	Failure and Contingency Analysis
GSE	Ground Support Equipment
GWe	Gigawatts Electrical
HEO	High Earth Orbit
HLLV	Heavy Lift Launch Vehicle
HLW	High Level Waste
IUS	Inertial Upper Stage
KSC	Kennedy Space Center
LEO	Low Earth Orbit
LeRC	Lewis Research Center
LMFBR	Liquid Metal Fast Breeder Reactor



LSL	Lunar Soft Landing
LWR	Light Water Reactor
M	Molar
MWD	Megawatt Days
MT	Metric Ton
NEPA	National Environmental Policy Act of 1969
NRC	Nuclear Regulatory Commission
ORNL	Oak Ridge National Laboratories
OTV	Orbit Transfer Vehicle
PCR	Payload Changeout Room
PWR	Pressurized Water Reactor
RCS	Reaction Control System
RMS	Remote Manipulator System
SRB	Solid Rocket Booster
SRM	Solid Rocket Motor
STS	Space Transportation System



## TECHNICAL PAPER

### NUCLEAR WASTE DISPOSAL IN SPACE

#### SUMMARY

The disposal of certain components of high level nuclear waste in space appears to be feasible from a technical standpoint. Disposal of all high level waste (Mix No. 1) in space is impractical because of the high launch rate required, and the resulting environmental impact, energy requirements, and economic factors. Thus, some form of waste separation will be required. A separation of just the unused uranium and cladding reduces the launch rate by a factor of approximately 40.

Of the five space destinations considered, the lunar surface and solar orbit options are the most attractive from an overall mission safety standpoint. Certain low probability subsystem failures could leave the waste package in an unplanned orbit from which it must be recovered. Thus, a prerequisite for flying either of the aforementioned missions is a demonstrated space rescue capability.

The Space Shuttle plus a high performance orbit transfer vehicle (OTV) are sufficient vehicles for space transportation of nuclear waste. Some Shuttle modifications will be required, but these should be considered as minor. A Shuttle derived heavy lift launch vehicle (HLLV) could be effectively utilized in the 1990 time frame if it becomes available.

Thermal control is one of the most difficult technical problems associated with the space disposal of nuclear waste. Due to the high thermal density and low thermal conductivity of the waste, the waste will either have to be packaged in a container with fins for conducting the heat to the outer surface, or encased in a metal matrix that results in a higher overall thermal conductivity. In either case, additional weight will have to be carried to solve the thermal problem.

Suitable state-of-the-art materials exist for the container and shielding although further work would be most helpful. A reentry protection system is required in case of catastrophic abort prior to achieving Earth orbit. This protection system will allow safe reentry and should be designed to withstand impact loads. As a result of the weight penalties for thermal control, shielding, ejection requirements, and reentry protection, the nuclear waste represents only approximately 15 percent of the total Shuttle payload weight.

The storage of nuclear waste in space does not appear to be an attractive option. Storage would generally be limited, time-wise, by the life time of the container. An



exception to this is the lunar surface mission since remote mining techniques could be employed to recover the waste from the lunar surface. Also, the cost of retrieving waste stored in space would be high in comparison with the original cost of transporting the waste to space. This is due to the increased mission operation complexity, and the fact that it requires more propellant to retrieve a payload than it does to deliver it.

Space disposal of nuclear waste is an option which offers permanent disposal of the waste, and has the unique characteristic that the mission risk period in which critical failure can occur is limited to a few days in the case of the lunar surface mission, and to approximately 6 months for the solar orbit mission. Failures can be detected in real time and corrective action can be initiated immediately.

## **I. INTRODUCTION**

### **A. Reason for the Study**

Recently, the subject of disposal of nuclear waste has received a lot of attention. Articles on this topic have appeared in many of the leading magazines and newspapers. In this country the Connecticut Yankee decision has restricted the growth of the nuclear power industry until a satisfactory solution to the nuclear waste problem is found. Thus, it appears that the nuclear waste problem threatens the nuclear power industry.

The U.S. Government Department of Energy (DOE) is currently studying the disposal of high-level waste in deep geological formations having good ion exchange potential, low permeability, no ground water, a stable history, and freedom from seismic activity. Sea bed disposal is also being considered. One of the biggest drawbacks to the two aforementioned techniques appears to be the lack of public acceptance, and as the public's awareness of nuclear waste problem increases this could become more of a problem.

The possibility of disposal of nuclear waste in space has been considered previously [1,2], and it was determined to be feasible from a technical standpoint. These studies only considered one destination, solar system escape, and one group of elements, the actinides, for space disposal. The purpose of this study is to expand the space options to include additional destination, various waste mixes, and identify Space Transportation Systems (STS) requirements for the space disposal of nuclear waste. The main intent is to identify problem areas and to compare the various options so that the most promising options can be analyzed in more detail.



## **B. Study Ground Rules**

To bound the scope of the study, the following ground rules were adopted:

- (1) Disposal and storage options should be considered.
- (2) Only domestic commercial reactor waste is considered.
- (3) Waste is at least 10 years old.
- (4) Various waste mixtures should be analyzed, ranging from total waste to very specialized waste products.
- (5) Conventional space vehicles should be emphasized.
- (6) Safety should be the main criterion for selecting preferred options and defining the overall mission profile.

In addition to these ground rules, which were adopted early in the study, there were options such as space destinations, type of space vehicles to utilize, etc., that were considered; however, the options had to be narrowed down to focus the analysis on the most promising and desirable concepts. Figure 1 presents the various study options.

## **C. Generation of Waste in Nuclear Reactors**

The commercial nuclear power industry in the U.S. currently has an operating capacity of approximately 50 GWe and plans to expand significantly in the future. These nuclear power plants discharge their spent fuel on approximately the basis of one-third of the reactor core annually, resulting in an accumulation of highly radioactive material which is very toxic, generates a considerable thermal inventory, and has nuclear half-lives of as much as hundreds of thousands of years. Unusable constituents of this fuel present a potential hazard to current and future generations if not disposed of properly. One possibility for disposal is to solidify the liquid wastes from reprocessing into a form which is inert to chemical attack or dissolution, encase it in massive containers, and dispose of it in government-controlled repositories on Earth for the eons of time required for its isolation.

Because of the length of time involved and the many potential changes in the Earth's crust during this time that could affect terrestrial or sea disposal, a decision was made to evaluate the concept of disposal of the waste in extra-terrestrial locations. This would conceivably result in less potential for undesired exposure of the population to this material by its permanent removal from the biosphere. The evaluation is considered to be conceptually valid for any nuclear fuel cycle which will generate waste materials.



<u>WASTE SOURCE</u>	<u>REACTOR</u>	<u>FUEL CYCLE</u>	<u>NUCLIDE MIX</u>	<u>WASTE FORM</u>
FOREIGN	LWR	U <sup>235</sup>	UNMODIFIED ROD BUNDLES	FUEL ELEMENTS
DOMESTIC CIVILIAN	LMFBR	U-Pu	FISSION PRODUCTS, ACTINIDES (INCLUDING PLUTONIUM), 0.5 PERCENT URANIUM	CALCINE POWDER
DOMESTIC MILITARY	HTGR	U-Th	FISSION PRODUCTS, ACTINIDES, 0.5 PERCENT (URANIUM + PLUTONIUM)	CALCINE GRANULES
			RARE EARTHS, ACTINIDES, 0.5 PERCENT (URANIUM + PLUTONIUM)	CALCINE PELLETS
			OTHERS	METAL MATRIX
				OTHER
<u>GROUND TRANSPORT</u>	<u>LAUNCH SITE</u>	<u>BOOSTER VEHICLE</u>	<u>ORBIT TRANSFER VEHICLE</u>	<u>DESTINATION</u>
RAIL	KSC	SPACE SHUTTLE	CRYOGENIC TUG	HIGH EARTH ORBIT
TRUCK	REMOTE ISLAND	SHUTTLE GROWTH DERIVATIVE VEHICLE	SOLAR ELECTRIC PROPULSION	HELIOCENTRIC ORBIT
WATER	LAUNCH PLATFORM AT SEA	EXISTING LAUNCH VEHICLE	NUCLEAR ELECTRIC PROPULSION	LUNAR ORBIT
AIR	OTHER		OTHER CHEMICAL PROPULSION	LUNAR SURFACE
				SOLAR ESCAPE
				SOLAR IMPACT
				PLANET SURFACE

☐ OPTION SELECTED FOR STUDY

Figure 1. Study options.



The reference nuclear reactor mix upon which this evaluation has been based consists completely of light water reactors (LWR) to the year 2000, which is the period of study selected to coincide with expected availability of the Space Shuttle as a transport vehicle. The scenario which is assumed for growth of nuclear capacity is that released by ERDA in late 1976 [3], designated as their Low Case, and reproduced as follows:

<u>Year</u>	<u>GWe</u>
1975	30
1980	60
1985	127
1990	195
2000	380

The liquid metal fast breeder reactor (LMFBR) was eliminated from consideration because of the unlikely commercialization in time to have solidified wastes available for disposal prior to 2000, i.e., with the 10-year elapsed time between reactor withdrawal and waste disposal.

The LWR's were considered to be operable in the "throwaway" mode without uranium or plutonium recycle and to be operated to a uniform fuel burnup of 33 000 MWD. This latter assumption is recognized as being slightly above general practice but, thereby, results in conservative design of system components. However, it is assumed that reprocessing facilities are available where it might be desirable to go through the head end (chop and dissolve fuel from elements) of reprocessing to generate a waste stream consisting of the entire fuel assembly, less hulls. Such an activity was conceived as a method of substantially reducing the waste volume as compared with disposal of complete fuel assemblies. The LWR waste situation was also examined from the standpoint that either uranium or plutonium, or both, might be separated from the waste stream and ultimately recycled. Finally it was considered that there should be the capability to separate (i.e., selectively remove) some nuclides from the liquid waste and thus achieve the flexibility of choosing specific isotopes for space disposal while leaving less hazardous materials on Earth where they might be safely stored in engineered facilities.



#### **D. Character of High-Level Waste and the Need for Isolation**

The high-level nuclear wastes derived from reprocessing of spent reactor fuel assemblies are produced when the assemblies are mechanically chopped and the fuel pellets are then dissolved in 2 to 3 M nitric acid. Uranium and plutonium are then coextracted from the aqueous solution into an organic phase of tributyl phosphate dissolved in kerosene. The two actinides are subsequently separated by selective oxidation and solvent extraction and in the fuel recycle mode of reactor operation are then sent back into the fuel fabrication plants.

The aqueous raffinate from this process is generally considered the high-level waste. The major constituents are the fission products; the actinides which include all of the neptunium, americium, and curium and small amounts of uranium and plutonium; and nitric acid. In addition, there are lesser amounts of corrosion products and deliberate inert additives (e.g., Gd, Fe, Cr, Ni, Na, etc.) used for control of chemical reactivity. The precise composition of this waste depends on a number of variables [4]. The nuclides present are a function of the reactor type, the original fuel composition, burnup achieved, the time elapsed from reactor discharge, and other factors such as slight changes in reprocessing chemistry.

While not normally considered as high-level wastes, there are gaseous isotopes of xenon, iodine, krypton, carbon, etc., which are released during reprocessing. It may be desirable or required to capture and immobilize these materials to minimize human exposure.

#### **E. Previous Studies**

The feasibility of transporting radioactive waste from commercial nuclear power plants into space was first investigated in 1973 by NASA, Lewis Research Center (LeRC) [1] at the request of the Atomic Energy Commission (AEC). The results of this exploratory study indicated that disposal into space of the long-lived actinides appeared feasible, from both an economic and safety viewpoint. Like the current study, the LeRC study utilized the Space Shuttle and a cryogenic upper stage as the space transportation vehicles. A major difference between the current study and the LeRC study was the method of shielding the nuclear payload. The heavy radiation shields were carried to the final destination in the LeRC study, whereas in the current study the shields are removed and returned to Earth for reuse once the payload is in low Earth orbit. Removing the shields in low Earth orbit increases the actual amount of nuclear waste that can be carried on a single flight by a factor of 5 to 6. The only space destination considered in the LeRC study was solar system escape.



Reference 2 describes a space disposal concept that utilizes the decay heat of actinide wastes to power an electrically propelled space vehicle. The vehicle is launched by the Space Shuttle to Earth orbit and to Earth escape by a cryogenic upper stage. The electrically powered vehicle is a high performance vehicle and can carry approximately 4 to 5 times the payload of a chemically powered upper stage. One main drawback to this concept is that the flight time to reach solar system escape is 848 days, and this imposes a severe lifetime requirement on all subsystems. Also, this approach requires a high thermal density payload and would limit the nuclear waste payload to the actinides.

The current study is broader than the two studies previously described in that various space destinations and various mixes of the nuclear waste are considered.

## **F. Comparison of Space and Terrestrial Options**

Even at the present level of understanding, it is apparent the space and terrestrial options for nuclear waste management have differing characteristics.

The Earth isolation methods have the advantage of requiring relatively standard transportation schemes to reach the containment site, i.e., there are relatively few problems with delivery. Once the containment site has been reached and emplacement operations completed, long term problems could arise. The extremely long periods of confinement that are required cannot necessarily be assumed because the geologic structure is quite ancient already. Physical conditions change when thermally hot wastes are implanted in such an area. Furthermore, catastrophic events such as earthquakes or intrusive acts by deranged humans are always a possibility. Lower level failures (such as a breach by ground water) could occur over geologic time periods without visible evidence for many years.

The space option has a very different set of problems. The entire risk in space disposal occurs during transport to the destination. Once the destination has been attained, the laws of physics then preclude an accidental return of the waste to man's environment. (Catastrophic events of the level of planetary collisions are excluded, but, in such a case, nuclear waste could hardly be considered to pose any additional hazard.) Intrusive acts by man under the space option can be logically ignored because the technology required to attain space travel is more complex than that required to generate nuclear waste.

Another important distinction that occurs between the Earth and space options is that a failure in space would be detected in real time and corrective action would be immediately initiated. The risk associated with space disposal is of importance if an accident can occur which would result in a noncorrectable situation.

This report will discuss the design of a space disposal mission which attempts to preclude noncorrectable events.



## **II. POST-REACTOR PROCESSING**

### **A. Waste Projections**

The practicality of disposal of nuclear waste in space depends very strongly upon how much nuclear waste will be generated. Although space offers complete isolation of waste from the biosphere, it is a rather exotic method of disposal and could not be considered for many toxic substances (such as industrial wastes). Nuclear power is a unique industrial process in that it produces very small amounts of very toxic waste. This combination makes space disposal a viable option.

Projections of nuclear generating capacity are given in Reference 5. From these projections, the amount of accumulated waste can be estimated if the type of reactor to be utilized in the production of power is also assumed [5]. It should be noted that these projections are not absolute, however.

The utilization or nonutilization of a breeder reactor could similarly modify the projections of accumulated waste. As with any natural resource, estimates vary on just how much uranium is available. Without a breeder the supply of uranium could be a limiting factor on just how much nuclear power could exist.

Other considerations that will affect the total mass of waste accumulated in the world come from foreign countries. These countries make choices that do not depend upon the decisions of the U.S. and can be expected to operate independently of the U.S. Nonetheless, our environment will depend upon their decisions since nature does not recognize man-made laws.

The present study deals only with civilian U.S. waste. The projections of Reference 5 are summarized in Figures 2 and 3.

### **B. General Discussion of Separation of Nuclear Waste Products**

Nuclear waste products arise when a fissionable atom (generally Th, U, or Pu) absorbs a free neutron and breaks into two or more portions. In some cases, the absorption of an additional neutron does not result in fission but rather in a simple increase in atomic number. Subsequent radioactive decay can then create new elements of higher atomic number than the original atom. Those elements which result from absorption rather than fission are members of the actinide family and will be so called.



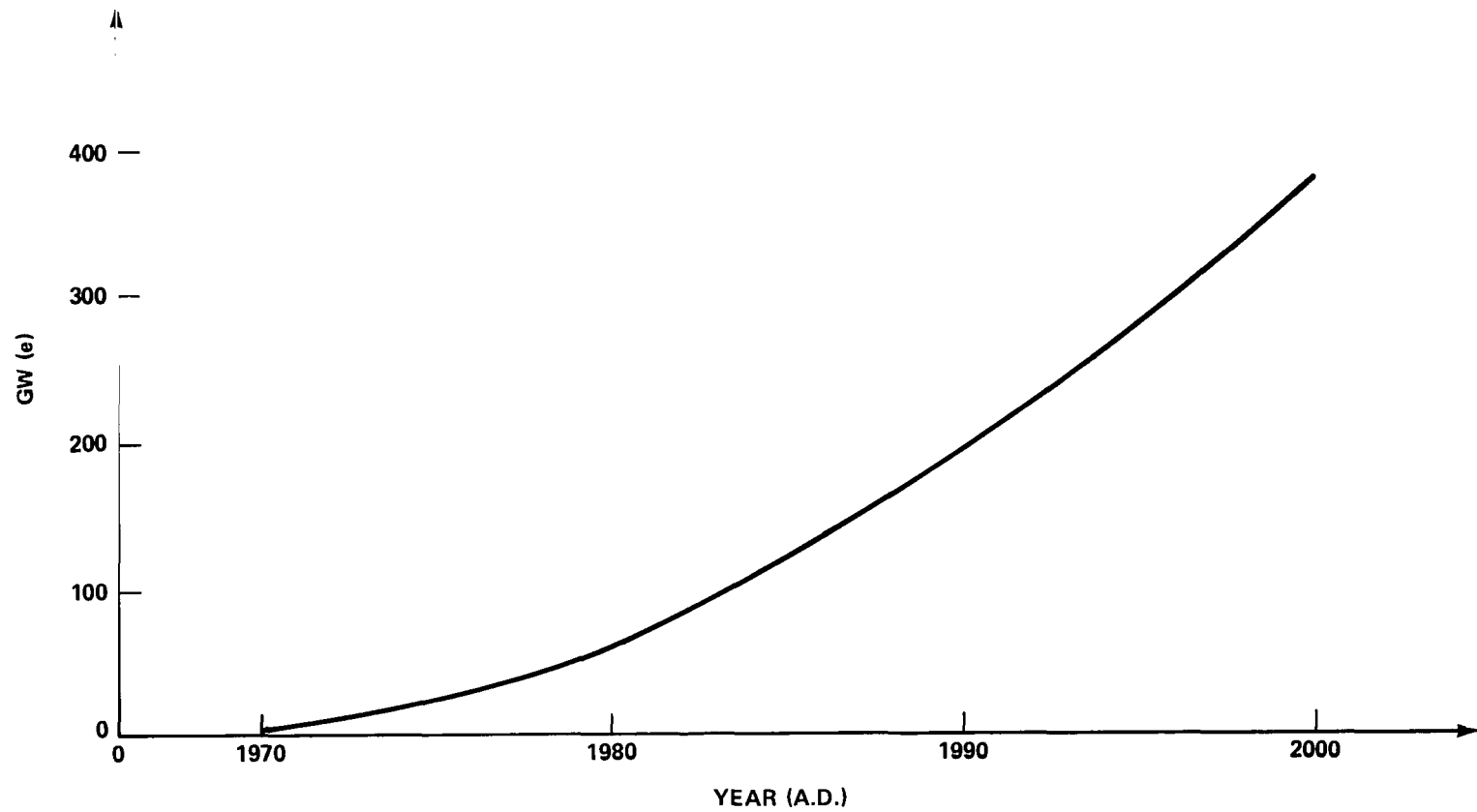

Figure 2. U.S. nuclear power generating capacity GW(e).



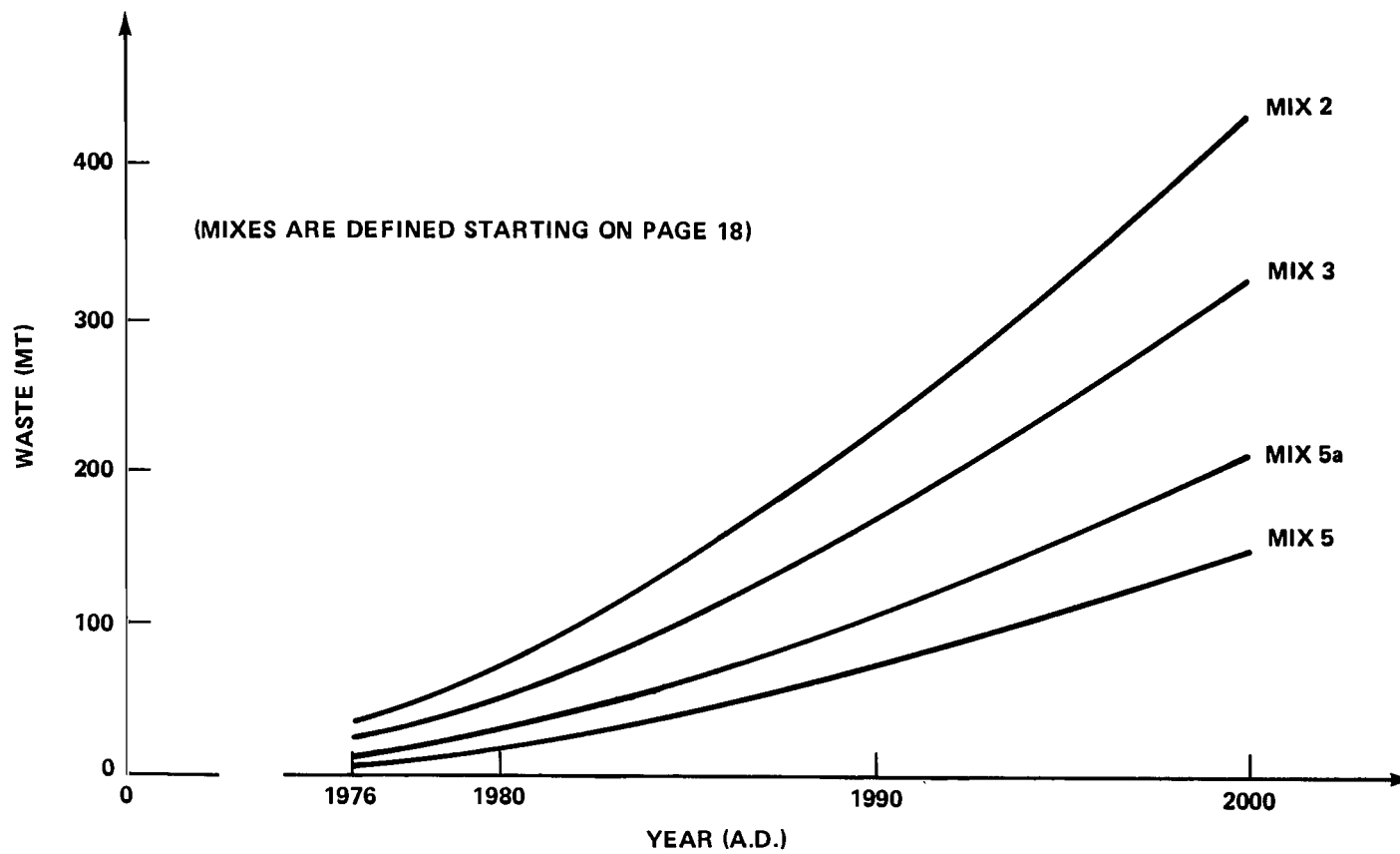

Figure 3. Waste generated by U.S. nuclear power industry.



The disposal/management of nuclear waste is simplified if these nuclear waste products can be separated into groups. If the discussion of separation is restricted to a uranium cycle reactor,<sup>1</sup> several distinct components of the spent reactor rods can be immediately identified:

(1) "Unburned" uranium — This is uranium which was unaffected by neutron absorption. Since the original fuel was a mixture of the isotopes  $U^{235}$  and  $U^{238}$ , the unburned uranium will also be a mixture of the same isotopes. This is, by far, the largest single component of the spent rods.

(2) Cladding (which has been used to encapsulate the uranium fuel) — This is usually an alloy called zircalloy, consisting primarily of zirconium as well as small amounts of tin, chromium, and nickel [7]. This is the second largest component, by weight, of the spent rods. It usually constitutes approximately one-fourth to one-third the weight of a reactor rod bundle.

(3) Fission products — These were mentioned previously and will be further discussed.

(4) Actinide elements — These were mentioned previously and will be further discussed.

(5) Additional impurities — Although not a component of the original waste, certain other elements will necessarily be introduced into the wastes as processing occurs. These impurities come from such varied sources as corrosion of pipes (Fe, Cr, Ni, etc.), absorption of neutrons by nitrogen to produce carbon ( $C^{14}$ ), other additives directly related to processing, etc.

To quantify the problems of separation, we begin with a discussion of exactly what elements can be expected to be present in the spent rod. While there is a nonzero probability that any element could be created by uranium fission, many of the elements are present in negligible quantity; therefore, we concentrate on the section of the periodic table between germanium ( $Z = 32$ ) up to, and including, erbium ( $Z = 68$ ). In addition, the actinides begin, effectively, at uranium ( $Z = 92$ ) through curium ( $Z = 96$ ). Elements below uranium occur (due to decay) as well as elements above curium, but their concentrations are totally negligible. Besides a simple inventory of the wastes, certain properties of the existing isotopes are important for considerations of space disposal. These properties include the gamma radiation output (which affects shield design), thermal output (which affects system design), mass percentage of the particular element (which affects space flight launch rates), toxicity (which gives a measure of the urgency that it be eliminated), etc. Thus, many parameters must be known to design a system for space disposal.

---

1. Numerous types of reactors are used for various applications; for this report a PWR which has a neutron flux of  $3.89 \times 10^{13}$  n/cm<sup>2</sup> s and a fuel burnup at 33 000 MWD is assumed. The program used in calculation of the individual waste components is found in Reference 6.



Additional considerations which are harder to quantify also play important roles in space disposal. For example, the chemical separability of a given element may be more important or less important depending upon some or all of these considerations. Additional chemical/physical properties are dependent upon the specific form of the wastes, i.e., density, thermal conductivity, corrosive behavior with respect to container material, etc. The sum total of these comments is that a comprehensive design of the content, form, and systems integration for nuclear waste disposal is very complex. The comments here should outline the problems that exist and indicate directions that show promise. At this time, however, a full description cannot be given.

Table 1 shows some important properties of the fission products and actinide elements that occur in the waste mixture.

### C. Waste Mixes for Evaluation

The purpose of space disposal of nuclear waste is to minimize radioactive hazards to man and the environment. This simple statement has rather complex implications.

To best realize the trades that must be made to minimize hazards, consider the implications of sending various fractions of the waste to space. If the fuel rod bundles were removed from a reactor and sent, in toto, to space there is no difficulty with spreading the material during chemical processing since there is no processing. In this case, however, a very large number of space flights will be required and the possibility of an ascent failure is obviously increased (even when excluding the economics and energy penalties involved). If some subfractions of the wastes are eliminated, then the economic and energy penalty considerations become more favorable and fewer flights improve ascent safety; however, we are now faced with the requirement of operating a separation plant in a secure and efficient manner, which is no small task.

The energy penalty for carrying all nuclear wastes exactly as it comes from the reactor (previously mentioned) involves two considerations. The most obvious of these is the fuel required to launch the waste into space, including such components as petroleum to haul the waste, gasoline expended by employees, and (of dominant importance) the fuel for the spacecraft. A second major component of the energy penalty is the fact that unused fissile materials are being wasted. The original mined uranium, before enrichment, contains only 0.71 percent of the fissionable isotopes  ${}_{92}\text{U}^{235}$  and the concentration of this isotope is increased to approximately 3.3 percent (via enrichment) for reactor operation. The removed reactor rods contain approximately 0.843 percent of the  ${}_{92}\text{U}^{235}$  isotope, which is a valuable fuel source. Additionally, the plutonium formed in the reactor is also a valuable fuel source; however, separation of the plutonium presents a potential security risk in that it can be used to construct fission weapons. This risk is sufficiently serious that the present administration has baselined geologic storage of unprocessed reactor rods. If this policy remains in effect there is only a small chance that space disposal is a viable option due to the reasons of economics and energy penalty.



TABLE 1. PROPERTIES OF THE FISSION PRODUCTS AND ACTINIDE ELEMENTS THAT OCCUR IN THE WASTE MIXTURE

Element	Density of Element (gm/cc)	Thermal Conductivity of Element (W/m °K)	Melting Point of Element (°C)	Stability of Element <sup>a</sup>
Ge	5.32	33.8 @ 500	937	Rather stable
As	5.73	18.2 @ 500	817	Rather unstable
Se	4.28	0.528 @ 300	217	Burns at elevated temperatures
Rb	1.53	113 @ 500	39	Very unstable
Sr	0.254	28 @ 500	769	Very unstable
Y	4.47	18 @ 500	1523	Rather unstable
Zr	6.51	21 @ 500	1852	Very stable
Nb	8.57	56.7 @ 500	2468	Oxidizes at high temperature
Mo	10.22	130 @ 500	2617	Oxidizes at high temperature
Tc	11.5	49.8 @ 500	2172	Rather unstable
Ru	12.41	113 @ 500	2310	Oxidizes at high temperature
Rh	12.41	140 @ 500	1966	Oxidizes at red heat
Pd	12.02	75.5 @ 500	1552	Very stable
Ag	10.50	413 @ 500	962	Very stable
Cd	8.65	92 @ 500	321	Burns at elevated temperatures
In	7.31	37.2 @ 500	157	Stable
Sn	5.75	30.2 @ 500	232	Oxidizes
Sb	6.69	19.4 @ 500	631	Burns at elevated temperatures
Te	6.24	~ 2 @ 500	450	Oxidizes
Cs	1.87	20.5 @ 500	28	Very unstable
Ba	3.5	18.4 @ 300	725	Very unstable
La	6.15	16.2 @ 500	920	Rather unstable
Ce	6.66	15 @ 500	798	Unstable
Pr	6.64	14.7 @ 500	931	Rather unstable
Nd	6.80	17.3 @ 500	1010	Rather unstable
Pm		18.5 @ 500	1080	Rather unstable
Sm	7.40	13.5 @ 500	1072	Rather unstable
Eu	5.24	14.2 @ 300	822	Unstable
Gd	7.90	9.28 @ 300	1311	Rather unstable
Tb	8.23	10.4 @ 300	1360	Rather unstable
Dy	8.55	11.4 @ 500	1409	Rather unstable
Ho	8.80	14.1 @ 500	1470	Rather unstable
Er	9.07	14 @ 500	1522	Rather unstable
U	18.95	31.7 @ 500	1132	Stable
Np	20.25	6.3 @ 300	640	Unstable
Pu	19.84	6.74 @ 300	641	Unstable
Am	13.67		994	Unstable
Cm	13.51		1340	Unstable

a. With respect to air and water attack at elevated temperatures.



To minimize the number of space flights required, we proceed under the assumption that separation of the waste into subfractions is an integral part of the space disposal scheme. It will also be assumed that the plutonium, if it is removed, will either be recycled as reactor fuel or sent to space if desired. This separation could proceed as follows.

The present technology calls for water storage for cooling of spent reactor rods for 6 months to 1 year. At that time the rods are mechanically chopped into small pieces and leached with nitric acid. This process removes some of the mass of the rods. The cladding hulls are eliminated<sup>2</sup> and certain gasses (Xe and Kr) as well as low boiling point elements (Br and I) are eliminated. Standard treatment, as detailed in Reference 8, removes 99.5 percent of the uranium and plutonium.

Removal of the cladding will eliminate one-fourth to one-third of the initial mass. The mass loss of the dissolved waste during processing (per metric ton of charged uranium) is as follows:

- (1) 99.5 percent of uranium removed: Removes 95.12 percent of initial mass
- (2) 99.5 percent of plutonium removed: Removes 23.25 percent of residual mass left at the end of step 1.
- (3) 100 percent of xenon removed: Removes 11.26 percent of residual mass left at the end of step 2.
- (4) 100 percent of krypton removed: Removes 1.34 percent of residual mass left at the end of step 3.
- (5) 99.5 percent of iodine removed: Removes 0.503 percent of residual mass left at the end of step 4.
- (6) 99.5 percent of bromine removed: Removes 0.010 percent of residual mass left at the end of step 5.

The original waste mass has thus been reduced from approximately  $1.3 \times 10^6$  gm (including cladding hulls) to  $3.3 \times 10^4$  gm, a reduction factor of approximately 40. Since space payloads tend to be mass limited, this reduction is critical, and such reduction can be accomplished by present day technology. This discussion illustrates the importance of

---

2. It should be noted that the cladding hulls are contaminated by actinides (alpha activity) as well as fission fragments. It appears that this activity can be essentially eliminated by use of electro-polishing the fabricated hulls (before or after usage) and subsequent nitric acid washing during the reprocessing.



trade studies in the space disposal scheme. The fate of the uranium is eventual recycle. Plutonium could be recycled to the reactor or carried to space. Xenon is not radioactive and is chemically inert; it may be used industrially or dispersed as desired. Krypton is radioactive (half life of 10.6 years) and may be stored, used industrially, or carried to space. Space disposal of krypton is certainly possible and will be discussed at a later time. The bromine is not radioactive after a very short time and can be used or disposed of in an approved manner for chemically toxic waste. Iodine presents a special health hazard in that it is radioactive with a half life of  $1.7 \times 10^7$  years and is concentrated by living organisms, primarily in the pituitary gland. It could form a separate space payload in itself, as is discussed later.

Certain waste mixes<sup>3</sup> which have been considered in the space disposal study are defined in this section, with the advantages and disadvantages presented. One point, which is potentially confusing at this stage of the discussion (to be detailed later), is the use of the term "problem elements." These are elements which pose special corrosion and/or volatilizing properties. Their elimination from the waste mix, while not required, would greatly simplify packaging.

1. Mix 1. Mix 1 is the minimal treatment case. The spent rods are removed from the reactor and sent to space with no treatment other than age cooling. This mixture is considered unsuitable for space disposal because it is simply too massive for transport (i.e., high flight numbers). Further, it has an unfavorable energy penalty and poor economics. It does have the advantage of requiring no chemical processing. This mix contains all problem elements.

2. Mix 2. Mix 2 requires some processing. The rods are chopped and leached with nitric acid and the cladding hulls are thus removed. The uranium and plutonium are then removed, and the plutonium is returned to the waste mix. Using present technology, it is not possible to remove only uranium. (Work is underway on advanced separation schemes that would remove only uranium.) In the process, krypton, xenon, iodine, and bromine are also removed. This mixture has one distinct advantage, namely it employs present processing technology yielding a massive weight loss compared to Mix 1. Thus, it can be handled with a reasonable number of space flights (flight densities will be discussed in Section VIII.) The disadvantages of the mixture include a rather high mass (compared with other mixes to be discussed), a high thermal density (Table 2), and a high gamma and neutron flux. The requirement that plutonium be removed (together with the uranium) and then added back to the mixture means that (in the standard case) there is a time point at which isolated plutonium exists, i.e., a possibility of theft exists.

3. The waste mixes defined in this section are designated as Mixes 1, 2, 3, 4, 4A, 4B, 4C, 5, 5A, 6, 7, 8, and 9. These designations have grown historically and have not been renumbered in order to retain consistency with previously published material.



The problem is minimal, however, in that the form of the plutonium (a liquid) is unsuitable for transport and isolation of plutonium would occur only under extremely inaccessible conditions. This mix contains all of the problem elements.

3. Mix 3. Mix 3 is simply Mix 2 without the readdition of removed plutonium. It has advantages over Mix 2 in that there is a further reduction of mass and the mixture has a lower thermal density. There would also be some reduction in neutron flux (but not gamma radiation) as compared to Mix 2. It must be assumed that the removed plutonium will be used as a nuclear fuel, i.e., the plutonium cannot be buried because it is one of the chief hazards to the biome. This mix, as with Mixes 1 and 2, is current technology, but it contains all of the problem elements.

4. Mix 4. Mix 4 is a refinement of Mix 3. Several submixes will be defined for convenience. These represent subtractions of specific elements or groups of elements from Mix 3.

5. Mix 4A. Mix 4A is Mix 3 with the removal of zirconium, molybdenum, and niobium. These elements are removed for several reasons. First of all, they are at worst, only very mildly radioactive (Zr, Nb) and present no appreciable hazard for geologic disposal. Second, they are rather easily separated from the residual mass under conditions of present technology and, although niobium is present only in very small quantities, the mass of zirconium and molybdenum are extremely large in relationship to the other fission products. Indeed, these elements form >21 percent of the entire mass of Mix 3. This is a very significant reduction.

6. Mix 4B. Another element which can be left on Earth with little hazard and which is a tempting chemical target from the separation point of view is cerium. Cerium constitutes 7.2 percent of Mix 3. (If it were to be removed in addition to Zr, Nb, Mo, the total mass reduction of Mix 3 would be approximately 28.4 percent.) Cerium does present one major chemical processing problem in that it is almost always separated in the +4 valence state. This implies oxidizing conditions which generate difficult corrosion problems. The radioactive isotope of cerium,  $_{58}\text{Ce}^{144}$  is a strong gamma emitter but has a half life of only 289 days. It could be readily stored geologically. Mix 4B is defined as Mix 4A without cerium.

7. Mix 4C. It is also desirable to remove other elements which contribute heavily to the bulk of the wastes — yet which present no major toxicity hazard if they were to remain on Earth. Some of these elements, along with the pros and cons of their separation, will be discussed. It will be found that Mix 4C is a compromise between what could be eliminated in theory and what can be eliminated in practice. During the discussion it should be remembered that separation of a waste product from the bulk of the wastes entails at least three aspects. The first aspect is that the separated product must be exceedingly clean of long lived isotopes (i.e., very low activity) if it is to be



disposed of on Earth or utilized as an industrial resource. The second aspect is that the chemistry must be quite simple and thus not result in side stream contamination that would result in a growth of the gross waste volume. The third aspect (that ameliorates the first two to some extent) is that residue of a removed element in the remaining waste is harmful only insofar as it adds mass to that waste. Thus, a cut that removes 50 percent of an inert element from the waste and does so cleanly and simply is a definite gain. The only caveat is that we cannot have contamination of the residue waste which is to remain on Earth.

a. Uranium. Although 99.5 percent of the initial uranium has been removed from the initial wastes, uranium is still the largest single component of the waste. If it could be completely removed, 13.9 percent of the mass would be eliminated. This could be simply readded to the originally cut uranium.

b. Neodymium and Lanthanum. These are inert and their terrestrial usage and/or disposal would present no problem. But they are rare-earths and as such are virtually impossible to remove except in conjunction with removal of all rare-earths. While they constitute 15.7 percent of Mix 3, this cut is not realistic and shall not be considered.

c. Ruthenium, Rhodium, and Palladium. All elements of this group are noble metals with extremely complicated chemistry (Ruthenium exhibits more valence states than any other element of the periodic table; rhodium is not much better.) The reasons for their removal are many. Ruthenium, for example, tends to be quite volatile and presents vapor pressure problems that hamper container design. (It is a chief "problem element.") The ruthenium-rhodium decay chain gives birth to  ${}_{45}\text{Rh}^{106}$  which is an especially nasty gamma emitter — indeed, it sizes the gamma ray shield to a large extent. Thus, its presence is far more costly to the mass of the final system than is indicated by the small mass quantity of the element which is present. The sum of three elements constitute approximately 11.5 percent of the mass of Mix 3 and thus are also a heavy weight penalty. These elements are of important industrial potential — they are used as catalysts, jewelry, and applications wherein corrosion resistance is critical. (The U.S. depends upon importation of the needed supplies, much of it from Russia.) Finally, ruthenium and rhodium have short half-lives and could be readily stored until they are used. Palladium is mildly radioactive with a half-life of  $7 \times 10^6$  years for one isotope. From this discussion it is apparent that there is ample reason to remove these elements from the waste. The technology, while not presently available, probably could be developed.

d. Barium. Barium is a large constituent of the wastes (4.6 percent) and is a strong gamma emitter. But the gamma emission isotope ( ${}_{56}\text{Ba}^{137\text{M}}$ ) is driven by cesium so that the removal of barium would not decrease the gamma shield requirements. If barium could be removed without contaminating it with strontium or other elements, such a cut is highly desirable from the mass reduction point of view.



There are other components of the waste mixture that could be eliminated for Earth-usage/disposal but they occur in sufficiently small quantities that the trouble in extracting them is probably not returned in reduced payload requirements.

To summarize, if zirconium, molybdenum, niobium, cerium, uranium, ruthenium, rhodium, palladium, and barium can be eliminated from Mix 3, the mass of waste to be carried could be reduced by approximately 59 percent and the residual Earth hazard would still be approximately zero. Even partial elimination of these elements would have a beneficial effect in proportion to the percent elimination. For purposes of notation we define Mix 4C as Mix 3 with all nine of the above listed elements removed.

8. Mix 5. Mix 5 represents a rather strong break with the previous cases in that most of the waste (including certain radiologically toxic isotopes) are left on Earth. Mix 5 is the sum of the rare-earth elements and the actinide elements (excluding cerium, uranium, and plutonium). The separation required to achieve this split is not simple and would have to result from development work to guarantee a significantly lowered hazard index for the waste left on Earth.

The first advantage of this mix is that it is of relatively low mass (approximately 46 percent of Mix 3). If we assume that uranium and cerium are also removed, in toto, then it is only approximately 25 percent of the mass of Mix 3. Furthermore, this mix removes almost all of the long-term toxicity for the nuclear wastes. (The biologically hazardous long-lived alpha emitters of the actinide isotopes are included in Mix 5.) It should be noted that although the separation of the lanthanides (rare-earths) and actinides from the wastes is difficult, this separation is much easier than separating either of the two from each other. Nonetheless, an important difference is that this mix requires virtually complete separation of the waste to be carried from the waste which is to be left. This is a more difficult problem than a process which separates much of an inert waste from a mix that is to be carried to space.

9. Mix 5A. Mix 5A is a very different approach to the entire problem of waste separation. For reasons that will be discussed elsewhere, the physical heat which is produced by isotope decay is a driver in the design of a space transport system. In particular, melting of the wastes and evaporation of low boiling point components are special problems (due, in large measure, to the problem elements). In Mix 5A a physical separation of the wastes rather than a chemical one is assumed. The wastes are simply allowed to heat up (or are externally heated) to drive off all of the volatile elements. This process is not as simple as it sounds since corrosion of the physical plant is a problem. (Perhaps all-graphite equipment could be used and then burned to CO<sub>2</sub> and the residue recycled.) Thus, Mix 5A assumes that all relatively volatile elements have been boiled off (Ge, As, Se, Rb, Ru, Cd, Te, Cs, are good candidates – with others added or subtracted according to the oxidation state). There is not necessarily a total weight reduction with respect to Mix 3, because the two components would be sent to space with different packaging concepts. Nonetheless, a simplified engineering design would result for the package.



10. Mix 6. Mix 6 is a further refinement of Mix 5. In this case only the actinide group (Np, Am, Cm) is removed for space elimination. The actinides were the payload and thermal power source for the previously studied NEWSTAR concept (NEWSTAR utilized the decay heat from the actinides to operate thermionic generators for an electric thrust vehicle) [2].

The primary difficulty with this mix is the very difficult chemical separation involved. That is, if space disposal is used to shorten the geologic storage time required for Earth isolation of nuclear wastes, then separation of the long lives alpha emitters must be virtually complete. If, for example, a 99 percent separation of the actinides from the fission fragments (a difficult task) could be achieved, the residual 1 percent actinides would require storage conditions that are not significantly less stringent than if no actinide separation had occurred. If all of the neptunium, americium, and curium could be eliminated, they would constitute only 1.9 percent of the mass of Mix 3.

11. Mix 7. Mix 7, iodine, should be considered as a "supplementary mix" in that it would fly in conjunction with other mixes. The long lived isotope,  $^{129}_{53}\text{I}$ , is a prime biological hazard because it concentrates in the pituitary gland. It is readily separable (to 99.5 percent) from the other wastes. It could be transported as barium iodate,  $\text{Ba}(\text{IO}_3)_2$ , and seems to present virtually no difficulties from either the thermal point of view or with respect to radiation shielding. It represents only 1 percent of the mass of Mix 3 [as  $\text{Ba}(\text{IO}_3)_2$ ].

12. Mix 8. This mix,  $^{14}_6\text{C}$ , is the only presently considered mix that is not, per se, a direct result of the irradiation of uranium. This product is formed by the irradiation of nitrogen atoms (which are impurities in the fuel elements) by neutrons. It is a health hazard because carbon easily enters biologic chains. Although the  $^{14}_6\text{C}$  formed is of very small quantity, the material might be diluted with inert carbon. No estimate of the fraction of Mix 3 will be made, but it is a small number.

13. Mix 9. Mix 9 consists of only technetium. Technetium represents a biologic hazard because it tends to concentrate in the thyroid and because it "creeps" rapidly in geologic storage. The element would form a nearly ideal payload because it emits only beta radiation and has a very low thermal density. The primary difficulty is sufficient removal of technetium from the residual wastes to lower the hazard index. Current technology (approximately 94 percent removal) is of little value. Technetium constitutes approximately 2.5 percent of Mix 3.

A final payload (that is not a "mix," per se) was mentioned earlier. It is radioactive krypton gas which is separated from the other fission products at the initial leaching of chopped reactor rods. This gas has a half-life of 10.6 years. It is a strong beta emitter. Because the gas could not be transported as a component of the other mixes, it must be carried as a separate payload if space disposal is desired. The transportation of cryogenic liquid gasses is standard in the aerospace industry, and, as such, it could be



handled. The unique feature of this particular payload is that it is self-heating (due to radioactive decay). No design work has been accomplished for such a payload, yet it appears to be possible to transport it to space.

These mixes comprise the groupings that have been identified thus far as potential candidates for waste disposal in space. Although many of them do not rely on present technology, it should be remembered that, when necessary, processing chemistry has developed extremely simple, reliable, and efficient cut procedures (for example uranium and plutonium separations). If the decision is made to employ space disposal, there could be corresponding new processing, i.e., the preference might be not to employ methods which have been custom tailored to geologic disposal. Which of these mixes is optimal with respect to overall constraints is yet to be determined.

Table 2 lists the thermal density of each waste mix.

TABLE 2. THERMAL DENSITY OF EACH WASTE MIX

Mix No.	Thermal Density (W/gm)
1	0.00131
2	0.0379
3	0.0314
4A	0.0398
4B	0.04389
4C	0.0543
5	0.0130
5A	0.0299
6	0.0951
7	~0
8	~0
9	~10 <sup>-5</sup>



#### **D. Definition of Required Level of Partitioning**

As was stated in the previous section, a distinction must be made between separation of an inert waste product from the mass of nuclear waste and the separation of a toxic waste from the same mass.

If an inert element is separated from the waste, any residue of the element remaining with the bulk of the waste is harmful only because it increases the mass of the residue. In this sense, the elimination of even a small percentage of an inert substance is valuable for the space option if it can be accomplished simply and at low cost. This is the philosophy that was adopted in the outline of Mixes 2, 3, 4, 4A, 4B, and 4C.

Mixes 5, 6, 7, 8, and 9 were the converse problem in that the material that was to be sent to space was eliminated from the residue, and this residue remained on Earth. Consider Mix 6 as a specific example. In this case the actinide elements (neptunium, americium, and curium primarily) are eliminated from the waste and only these elements are sent to space. The question is not whether most of the actinides can be eliminated from the residue, but rather what percentage of actinides will remain in the waste.

Two constraints support the argument that a significant percentage of the actinides will remain behind. The first constraint is economic because such separations are expensive. The second constraint is technological in that processing is a diffusing (entropic) process. Some loss of material must be expected at each stage of separation; therefore, this may well be a virtually impossible problem to solve because the residue becomes increasingly free of the removed component.

The most reasonable definition of a "required level of partitioning" is that it is that level which significantly reduces the residual hazard for material left on Earth below that which would occur if space transportation of waste were not employed. By this definition it can be seen that elimination of, e.g., 99 percent of the actinides would be of little value. The residual 1 percent still poses a high toxicity risk.

The sum of these considerations leads to a choice of either Mix 1, Mix 2, or Mix 3 for space elimination. Mix 1 has been previously ruled out on energy grounds; therefore, the choice is Mix 2 or Mix 3. Mixes 4, 4A, 4B, and 4C could still be considered but only if they are proven out by future experimental programs. Mix 7 (iodine) and Mix 8 ( $C^{14}$ ) together with krypton could be carried as supplementary payloads.

It is concluded that Mixes 2 and 3 are reasonable for space transportation.



## E. Waste Forms

While in the previous section the specific constituents that could be contained in the waste under different levels of treatments were considered, a major consideration that has yet to be addressed is the chemical form in which the wastes are to be carried. This is important because the overall system design will depend upon the physical properties of the chemical form of the waste.

A few general characteristics can be listed as desirable:

(1) Mass density — Since the waste must be wrapped in heavy gamma ray shielding (and possible neutron shielding), it is of prime importance that as high a mass density as possible be achieved. Depending upon the geometry chosen and the amount of waste carried, the loss of one point in density can cost as much as 1500 kg in gamma shield weight for the configurations studied. It should be noted, however, that a higher mass density implies a higher thermal density per unit volume since the thermal output per gram of waste is a function only of age of the waste. Virtually every major subsystem of the waste disposal vehicle is ultimately dependent upon waste density.

(2) Thermal conductivity — The thermal conductivity of the mixture should be as high as possible. This is necessary to keep the central temperatures of the waste mix to reasonable levels. Other things being equal, conductivity would be expected to increase with increasing mass density.

(3) Melting point/vapor pressure — The mixture should have a melting point that is as high as possible. Additionally, there should be very low vapor pressure from the mixture to avoid container stress and possible rupture. It should be noted that if a high thermal conductivity can be had, the melting point/vapor pressure criterion becomes less important and conversely.

(4) Corrosive behavior — The waste form should be benign with respect to container material attack. This requirement can be offset by a careful choice of the container material.

(5) Environmental stability — The chosen waste form must meet stringent requirements in the extremely improbable case that the containment is ruptured. This means that the material should not be combustible at high temperatures in the atmosphere and should not dissolve either in freshwater or saltwater, even at elevated temperatures. Furthermore, the waste form should not be dispersable if rupture occurred upon impact.

These characteristics are extremely stringent and it should not be assumed that all of them will be met; indeed, it seems unlikely that any one of them will be fulfilled in a completely satisfactory manner.



1. Physical Properties. Several candidate waste forms have been considered and are discussed individually.

a. Elemental State. A number of properties of the fission products and actinides in the elemental state are listed in Table 1. It should be noted that the densities and thermal conductivities are high. While both of these features are very desirable, the elemental state cannot be seriously considered for several reasons. First, the resultant mixture (hardly an alloy) contains a large number of environmentally unstable elements. The mixture could not be expected to behave better than its components and would probably do much worse. Besides corrosion stability it would be expected to be brittle and probably heterogeneous. The elemental state has not been studied for waste products, and the development of such a form would undoubtedly be quite expensive. The elemental state is ruled out.

b. Glasses. One of the standard waste forms which have been carefully investigated for geologic disposal is the conversion of waste into a calcine (oxide) form and the incorporation of these oxides into phosphate or borosilicate glasses. This material has several advantages: it is very resistant to oxidation and/or dispersion and it is standard technology. The waste loading is low (approximately 25 percent of the total mass of the glass), therefore, the thermal density of the product is low. (The thermal conductivity is also low, as would be expected.) The low density of waste loading is the very factor which eliminates the possibility of using this waste form for space disposal. That is, the fact that approximately three-fourths of the mass is inert material immediately implies an increase of four times the space flights. This fact rules out glass waste forms for space.

c. Alternate Anions. Alternate anions in this case means nonoxide anions. Oxides, the standard form of nuclear waste, have been given considerable study but alternatives such as borides, carbides, and nitrides have been virtually ignored since there has been no need for them. These alternates (especially the borides) may have much to offer; however, difficulty arises in dealing with this branch of chemistry because it is virtually unknown. Certain literature [9] indicate that borides of some (probably all) rare-earths have a high thermal conductivity; however, most other needed data are missing. Furthermore, fabrication difficulties would probably be severe. The summary of the alternate anion concept is that there is simply not enough information to intelligently evaluate the concept. If enough interest is shown in space disposal, an entire research program could evaluate these compounds, but it is probably unnecessary. For the present time, they must be shelved.

d. Oxides. The waste oxides must be considered as the only practical form for space transportation. On the positive side it must be realized that existing processing can produce mixed oxides, and the properties of such a mixture have been partially investigated. The mass density of the oxides (2.5 to 4 gm/cc) is low, however, and the thermal conductivity is very poor (on the order of 0.6 to 1.8 W/m<sup>2</sup>K). The melting point and vapor pressure vary strongly with the specific element involved. The oxides and some



of their properties are presented in Table 3. One immediate result of this table is to indicate that although a large number of oxides are known to exist, many of their properties have not been experimentally determined [10,11]. The measurements of thermal conductivity are especially sparse. Additional data from this table show that although the individual oxides have rather high densities, these data are theoretical values for ordered crystals. Admixtures of oxides will not be nearly as high.

The listing of solubility of the oxides per 100 cc of hot water (the waste would heat water if contact occurs) indicates a rather high solution rate. Thus, oxides are not resistant to dissolution in many cases. Similarly, the oxides that are listed cannot be expected to remain in an unmodified state. Many of the listed oxides convert to other forms in the presence of oxygen, while some oxides release oxygen.

An even more striking occurrence is the fact that other compounds (other than oxides) will necessarily form in the oxide mixture. The most obvious of these compounds are molybdenates of the alkali and alkaline Earth metals. Interactions of this type essentially preclude completely theoretical calculations of waste oxide properties and we must rely on experimental determination of the waste properties.

Experimental determinations suffer from a lack of published results. The situation is further complicated by the fact that different type reactors will each produce (slightly) varying products and, finally, the waste mixture changes in time. Baseline values were accepted as follows:

Thermal conductivity: 0.6 to 1.8 W/m °K

Thermal density: See Table 2

Density: 4.0 gm/cm<sup>3</sup>

Melting point: On the order of 1000°C

Corrosive behavior: Oxidizing

Environmental stability: Better than the individual oxides.

The limiting factors of the oxide are the low thermal conductivity and the environmental dispersion potential of these compounds. An alternative "packaging" method that retains the oxide baseline yet largely overcomes these drawbacks is the metal matrix concept. The concept employs a continuous network of fine metal connectors that enmeshes the nuclear waste oxides within it. Each element of waste is thus only a very short distance from a metallic thermal conductor and the inherent conductivity of the waste becomes of little importance. The thermal control and environmental stability of the overall configuration become a function of the metal chosen to act as a matrix. A



TABLE 3. OXIDES AND SOME OF THEIR PROPERTIES

Element	Oxides	Density (gm/cc)	Solubility of Oxide (gm/100 cc Hot H <sub>2</sub> O)	Melting Point of Oxide (°C)	Thermal Conductivity of Oxide (W/m °K)	Comments on Thermal Stability
Ge	GeO	-	-	710	-	Sublimes >700°C. Decomposes >600°C
	GeO <sub>2</sub>	4.7	1.07	1116	-	Evaporates appreciably >1250°C
	GeO <sub>2</sub>	6.3	i	1116	-	Evaporates appreciably >1250°C
As	As <sub>2</sub> O <sub>3</sub>	3.87	76.7	586	-	Sublimes readily
	As <sub>2</sub> O <sub>5</sub>	4.09	10.1	>825	-	Decomposes to As <sub>2</sub> O <sub>3</sub> at 315°C
Se	SeO <sup>a</sup>	-	-	1100	-	Stable only as vapor at high temperature.
	SeO <sub>2</sub>	3.95	82.5	340 390	-	Sublimes readily
	SeO <sub>3</sub>	3.6	d	119	-	Decomposes above 185°C
Rb	Rb <sub>2</sub> O	3.72	d	627	-	Decomposes
	Rb <sub>2</sub> O <sub>2</sub>	3.80	-	570	-	Melts without decomposition
	Rb <sub>3</sub> O <sub>4</sub>	-	-	-	-	Unstable: decomposes
	Rb <sub>2</sub> O <sub>3</sub>	3.53	d	489	-	Melts without decomposition
	RbO <sub>2</sub>	-	d	412	-	Decomposes >567°C
Sr	SrO	4.7	22.9	2430	-	Stable
	SrO <sub>2</sub>	-	-	410- 450	-	Decomposes to SrO at 700° 800°C
	SrO <sub>4</sub> <sup>a</sup>	-	-	-	-	Decomposes
Y	Y <sub>2</sub> O <sub>3</sub>	4.84	-	2376	0.3	Stable
Zr	ZrO <sub>2</sub>	5.56 6.27	i	2690	2.3 (at 1000°C)	Very stable
Nb	Nb <sub>4</sub> O	-	-	350	-	Thermally unstable
	NbO	7.26	-	1945	-	Evaporates appreciably at ~1700°C
	NbO <sub>2</sub>	5.98	-	2002	-	Forms Nb <sub>2</sub> O <sub>5</sub> on heating in air
	Nb <sub>2</sub> O <sub>3</sub> <sup>b</sup>	-	-	1772	-	-
	Nb <sub>2</sub> O <sub>5</sub>	4.95	-	1510	-	Thermally stable
Mo	MoO <sub>2</sub>	4.11	i	1927	-	Partial sublimation at 1000°C, forms MoO <sub>3</sub> and Mo.
	Mo <sub>2</sub> O <sub>5</sub> <sup>b</sup>	-	-	-	-	Thermally unstable, forms MoO <sub>2</sub> and MoO <sub>3</sub>
	Mo <sub>4</sub> O <sub>11</sub> <sup>a</sup>	-	-	>700	-	Thermally unstable, forms MoO <sub>2</sub> and MoO <sub>3</sub>
	Mo <sub>2</sub> O <sub>3</sub> <sup>b</sup>	-	-	-	-	Thermally unstable, forms MoO <sub>2</sub> and MoO <sub>3</sub>
	Mo <sub>8</sub> O <sub>23</sub> <sup>a</sup>	-	-	>700	-	Thermally unstable, forms MoO <sub>2</sub> and MoO <sub>3</sub>
	Mo <sub>9</sub> O <sub>26</sub> <sup>a</sup>	-	-	>700	-	Thermally unstable, forms MoO <sub>2</sub> and MoO <sub>3</sub>
	Mo <sub>17</sub> O <sub>47</sub> <sup>a</sup>	-	-	-	-	Thermally unstable, forms MoO <sub>2</sub> and MoO <sub>3</sub>
	Mo <sub>10</sub> O <sub>28</sub> <sup>a</sup>	-	-	-	-	Thermally unstable, forms MoO <sub>2</sub> and MoO <sub>3</sub>
	MoO <sub>3</sub>	4.69	2.06	795	-	Sublimes appreciably above 650°C
	TcO <sub>2</sub> <sup>a, b</sup>	-	-	2127	-	-
Ru	Tc <sub>2</sub> O <sub>7</sub> <sup>a, b</sup>	-	-	120	-	-
	RuO <sub>2</sub>	6.97	i	1127	-	Sublimes at 27°C
Rh	RuO <sub>4</sub>	3.29	2.25	25	-	Decomposes explosively at 108°C
	Rh <sub>2</sub> O <sub>3</sub>	8.2	i	1388	-	Decomposes above 1000°C to the metal
Pd	Rh <sub>2</sub> O <sup>a</sup>	-	-	1127	-	Thermally unstable
	RhO <sup>a</sup>	-	-	1121	-	Thermally unstable
	RhO <sub>2</sub>	-	-	-	-	Thermally unstable
Ag	PdO	8.7	i	877	-	Decomposes to elements above 870°C
	Pd <sub>2</sub> O <sub>3</sub>	-	-	-	-	Unstable at room temperature
	PdO <sub>2</sub>	-	-	-	-	Converts to PdO at 200°C
Cd	Ag <sub>2</sub> O	7.14	0.005	1.87	-	Decomposes completely above 200°C
	Ag <sub>2</sub> O	-	-	-	-	Decomposes to elements at 100°C. Expl. at 110°C
	AgO <sub>3</sub> <sup>a</sup>	-	-	-	-	Extremely unstable
In	CdO	6.95 8.15	i	0.826	0.68 (at 47°C)	Sublimes at 700°C without melting
	CdO <sub>2</sub> <sup>a</sup>	-	-	-	-	Unstable, readily uses oxygen
Sn	InO <sup>b</sup>	-	-	1052	5.6	-
	In <sub>2</sub> O	6.99	-	327	-	Sublimes in vacuum at 650 700°C
	In <sub>2</sub> O <sub>3</sub>	7.18	-	2000	-	Conv. to In <sub>2</sub> O <sub>3</sub> at 850°C, then In <sub>2</sub> O
Sb	SnO	6.45	i	1042	-	Conv. to SnO <sub>2</sub> at 450°C
	SnO <sub>2</sub>	6.95	i	1625	-	Stable
	Sb <sub>2</sub> O <sub>3</sub>	5.2	sl.s	655	-	Sublimes readily
	Sb <sub>2</sub> O <sub>4</sub>	3.8 4.0	v.sl.s	930	-	Decomposes to Sb <sub>2</sub> O <sub>3</sub> above 900°C
Te	Sb <sub>2</sub> O <sub>5</sub>	3.78	v.sl.s	380	-	Stable to 357°C. Sb <sub>2</sub> at higher temperature
	TeO <sup>a</sup>	-	-	747	-	Stable only as vapor at high temperature
	TeO <sub>2</sub>	-	-	733	-	Sublimes at ~450°C



TABLE 3. (Concluded)

Element	Oxides	Density (gm/cc)	Solubility of Oxide (gm/100 cc Hot H <sub>2</sub> O)	Melting Point of Oxide (°C)	Thermal Conductivity of Oxide (W/m °K)	Comments on Thermal Stability
Cs	TeO <sub>3</sub>	5.08-6.21	i	400	-	Decomposes to TeO <sub>2</sub> above 300°C
	Cs <sub>2</sub> O	4.25	d	490	-	Evaporation begins of 550°C
	Cs <sub>2</sub> O <sub>2</sub>	-	-	594	-	Melts without decomposition
	Cs <sub>2</sub> O <sub>3</sub> <sup>a</sup>	4.25	d	502	-	-
Ba	CsO <sub>2</sub>	-	-	450	-	Decomposes above 597°C
	BaO	5.72	90.8	1923	-	Stable in absence of oxygen
	BaO <sub>2</sub>	4.96	s	450	-	Decomposes to BaO
	BaO <sub>4</sub> <sup>a</sup>	-	-	-	-	-
La	La <sub>2</sub> O <sub>3</sub>	6.51	d	2300	0.1 (at 150°C)	Thermally stable
Ce	Ce <sub>2</sub> O <sub>3</sub>	6.9-7.0	i	2157		Thermally stable
	CeO <sub>2</sub>	7.13	i	2427		Thermally stable
Pr	Pr <sub>2</sub> O <sub>3</sub>	7.07	-	2290		Thermally stable
	Pr <sub>6</sub> O <sub>11</sub> <sup>a</sup>	6.82	-	2042	2.96 (at 480°C)	Thermally stable
	PrO <sub>2</sub>	-	-	427		Thermally stable
Nd	Nd <sub>2</sub> O <sub>3</sub>	7.24	0.003	2315		Thermally stable
Pm	Pm <sub>2</sub> O <sub>3</sub>	-	-	-		Thermally stable
Sm	Sm <sub>2</sub> O <sub>3</sub>	7.4	-	2320	25.5 (at 600°C)	Thermally stable
Eu	Eu <sub>2</sub> O <sub>3</sub>	7.4	-	2330		Thermally stable
Gd	Gd <sub>2</sub> O <sub>3</sub>	7.41	v.sl.s	2395		Thermally stable
Tb	Tb <sub>4</sub> O <sub>7</sub>	-	-	2337		Thermally stable
	TbO <sub>2</sub>	-	-	-	-	Thermally stable
Dy	Dy <sub>2</sub> O <sub>3</sub>	7.41	-	2385	3.4 (at 1000°C)	Thermally stable
Ho	Ho <sub>2</sub> O <sub>3</sub>	-	i	2395		Thermally stable
Er	Er <sub>2</sub> O <sub>3</sub>	8.65	-	2400		Thermally stable
U	UO <sub>2</sub>	10.5	i	2760		Thermally stable
	U <sub>3</sub> O <sub>8</sub>	7.2	i	1450	0.35	Stable over 650° to 900°C. Decomposes at 1450°C
	UO <sub>3</sub>	5.02	-	652		Decomposes at 450°C
Np	NpO <sub>2</sub>	11.11	-	2327		Stable to 1000°C
	Np <sub>3</sub> O <sub>8</sub>	-	-	-	-	Decomposes at 600°C to form NpO <sub>2</sub>
Pu	PuO <sub>2</sub> <sup>a</sup>	b	-	1017	0.35	-
	Pu <sub>2</sub> O <sub>3</sub> <sup>a</sup>	b	-	1607		-
	PuO <sub>2</sub>	11.46	-	2240		Decompose in vacuum to Pm <sub>2</sub> O <sub>3</sub> Pu <sub>4</sub> O <sub>7</sub>
Am	Am <sub>2</sub> O <sub>3</sub> <sup>b</sup>	-	-	1952		-
	AmO <sub>2</sub>	11.68	-	-	-	Stable to 1000°C
Cm	Cm <sub>2</sub> O <sub>3</sub>	-	-	-	-	-

a. Not listed in the "Handbook of Physics and Chemistry," 54th edition, Chemical Rubber Publishing Company, Cleveland, Ohio.

b. Not listed in "The Oxide Handbook," edited by G. V. Samsonov, Plenum Press, New York, 1973.

Note: s - soluble  
i - insoluble  
d - decomposes  
sl.s - slightly soluble  
v.sl.s - very slightly soluble

number of metals have been suggested (such as molybdenum, copper, lead, and aluminum), and experiments have been carried out with a number of these. Some results are shown in Figure 4 and Table 4.<sup>4</sup>

The important questions that arise with respect to a metal matrix for space disposal are whether or not the metal can occupy a sufficiently small volume and mass percentage of the package that the method can be used for space transportation. It was found<sup>4</sup> that careful fabrication of such a composite can decrease the volume percentage

4. Personal communication with W. Pardue of Battelle Laboratories, Columbus, Ohio.



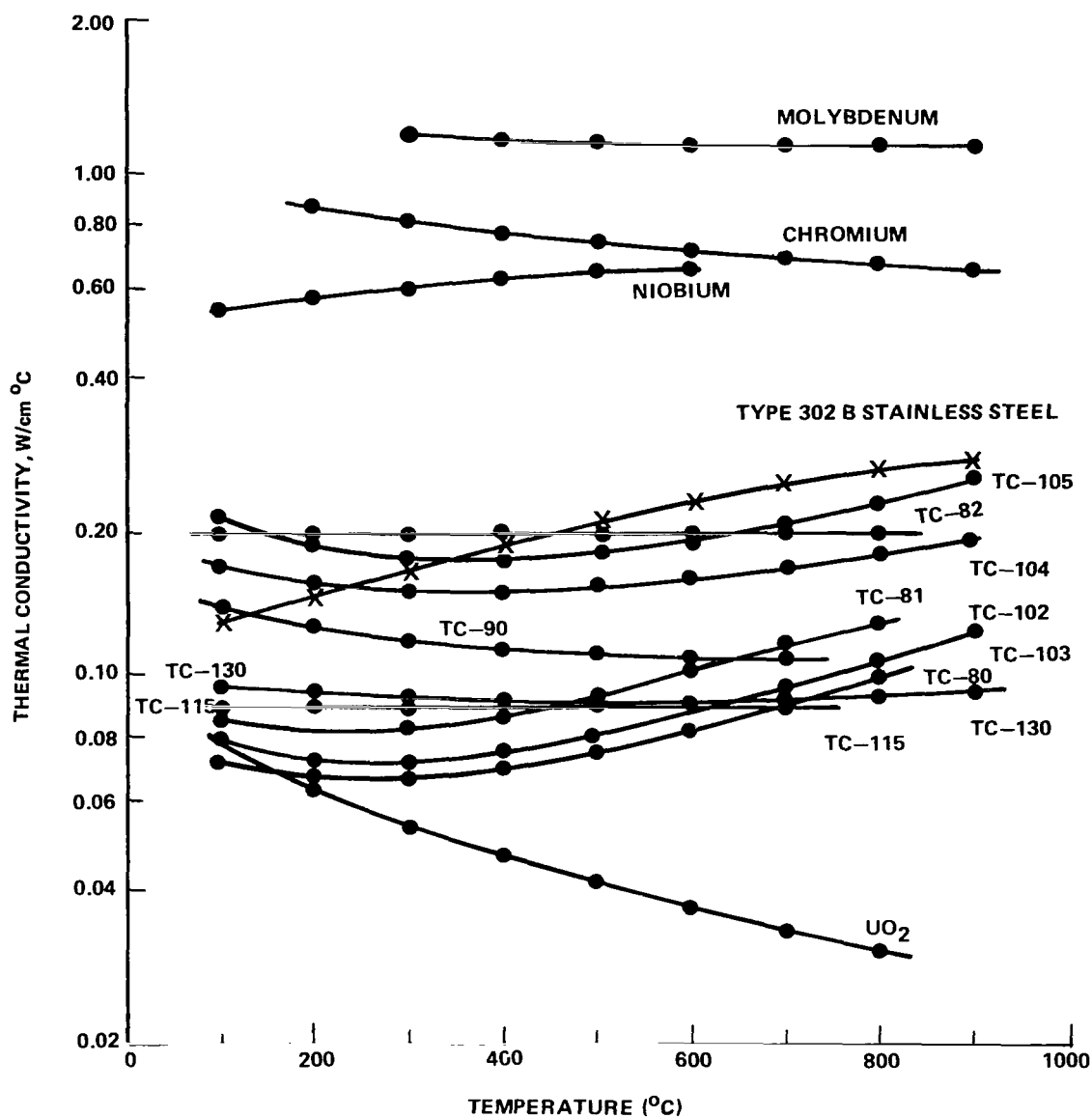

Figure 4. Thermal conductivity versus temperature for UO<sub>2</sub> cermet and their matrix metals.

of the metal to approximately 10 percent while retaining a conductivity of the same order of magnitude as the metal. The question of mass percentage, once the volume percentage has been fixed, is then a function of the density of the matrix metal. A metal such as beryllium, which is quite light and of high thermal conductivity, would be ideal – but questions of interaction between this metal and the waste oxides are not answered.



TABLE 4. DESCRIPTION OF SPECIMENS USED FOR PHYSICAL-PROPERTY MEASUREMENTS

Specimen	Nominal Composition (volume %)	Density (% of theoretical)	Physical Properties Measured			
			Thermal Conductivity	Linear Expansion	Electrical Resistivity <sup>a</sup>	Electrical Resistivity <sup>b</sup>
TC-81	UO <sub>2</sub> -30 stainless	97.0	X	X	X	—
TC-80	UO <sub>2</sub> -20 stainless	95.5	X	X	X	—
TC-102	UO <sub>2</sub> -20 stainless	98.4	X	X	X <sup>c</sup>	X
TC-103	UO <sub>2</sub> -20 stainless	97.2	X	X	d	X
TC-82	UO <sub>2</sub> -30 molybdenum	91.7	X	X	X	—
TC-90	UO <sub>2</sub> -20 molybdenum	91.1	X	—	X	—
TC-105	UO <sub>2</sub> -20 molybdenum	94.4	X	X	d	X
TC-104	UO <sub>2</sub> -20 chromium	97.1	X	X	d	X
TC-115	UO <sub>2</sub> -20 niobium <sup>e</sup>	85.3	X	—	X	—
TC-130	UO <sub>2</sub> -20 niobium <sup>f</sup>	93.5	X	—	X	—

a. Electrical resistivity measured concurrently with thermal conductivity.

b. Electrical resistivity measured independently of thermal conductivity.

c. Not reported.

d. Not calculated.

e. Niobium-coated minus 100 plus 140-mesh spherical UO<sub>2</sub>.

f. Niobium-coated minus 140 plus 200-mesh hydrothermal UO<sub>2</sub>.



2. Economics of Waste Forms. The previously mentioned considerations placed heavy emphasis upon the fact that waste oxides do exist and are standard technology. From this point of view, space disposal and geologic disposal are similar in that both begin with the same material. The costs of development of waste solidification to the oxide form could not justly be charged to space operations because these will exist in any case.

Several items are uniquely space related, however. The packaging of the waste for space disposal (to be described later in this report) will require a very high density, and this compaction could require specialized equipment. The metal matrix has been developed to its present state-of-the-art by nonspace programs, but research for the space-optimized package would be necessary.

Nonetheless, the costs borne in development of compaction techniques and metal matrix developments are quite small when compared to overall waste management costs. Only the undertaking of a major perturbation in the form of the wastes (i.e., nonoxides) could be expected to involve large sums for research and development.

Based upon these considerations of economics as well as the earlier comments on technological feasibility, the recommended waste forms must be either oxides or oxides in a metal matrix. This recommendation is in addition to the earlier choice that waste Mixes 2 or 3 be baselined for space disposal.

The remaining problem of low thermal conductivity and dispersibility of the oxides are considered in Section IV.

Recommended waste forms are oxides or oxides in a metal matrix.



### III. SPACE OPTIONS

The vastness of space offers many potential destinations for the placement of nuclear waste. Space offers options for both disposal where the waste is permanently removed from man's environment and storage where the waste may be retrieved at a later time if it is ever desirable to do so. Retrieval from space, except for the lunar soft landing mission, will be limited time wise by the container lifetime. The space destinations considered in this study are high Earth orbit (HEO), lunar orbit, lunar soft landing, heliocentric orbit, solar system escape, and solar impact. A comparison of the space destinations is presented in Figure 5. From launch to low Earth orbit (LEO) (160 n.mi. altitude), the mission scenario is the same for all destinations; however, the launch rate is different.

#### A. High Earth Orbit

Placing the nuclear waste in HEO requires the lowest  $\Delta V$  (4000 m/s above Shuttle orbit) of all the destinations considered, and this is the main advantage of the HEO orbit mission. Potentially, HEO could serve as a storage or disposal site. One of the main concerns with the HEO mission is orbit lifetime, and for this reason a high circular 55 000 km orbit was considered. To transfer the nuclear waste payload from the 160 n.mi. Shuttle orbit to the 55 000 km orbit requires two burns of the orbit transfer vehicle (OTV) main propulsion system, the second burn occurring approximately 15 h after the first burn. Thus, for the HEO mission the required vehicle system lifetime is approximately 18 h from launch to mission completion. The orbital altitude of 55 000 km was not optimized, but was picked because it was sufficiently high that aerodynamic drag was negligible and sufficiently low that lunar perturbation would be small. Also, it is desirable to choose an orbit that would avoid interference with the planned scientific satellites in LEO and in geosynchronous space. Thus, the minimum orbit radius must be greater than 42 241 km (geosynch radius). A detailed stability analysis would be required if the HEO mission becomes a serious contender for nuclear waste storage/disposal.

Launch for an HEO mission can occur on any day and at any time of day. If specific placement in HEO is required, it can be achieved by selecting the time of launch and by performing orbit phasing while in the Shuttle orbit (160 n.mi. altitude).

The OTV can place 5900 kg of payload into a 55 000 km circular orbit inclined  $28.5^\circ$  to the equator. However, the largest nuclear waste payload that can be carried by the Shuttle is 4408 kg. Thus, for the HEO mission the payload to orbit is limited by the amount of nuclear waste (plus shielding, cocoon, and cooling equipment) that can be carried to LEO by the space Shuttle.



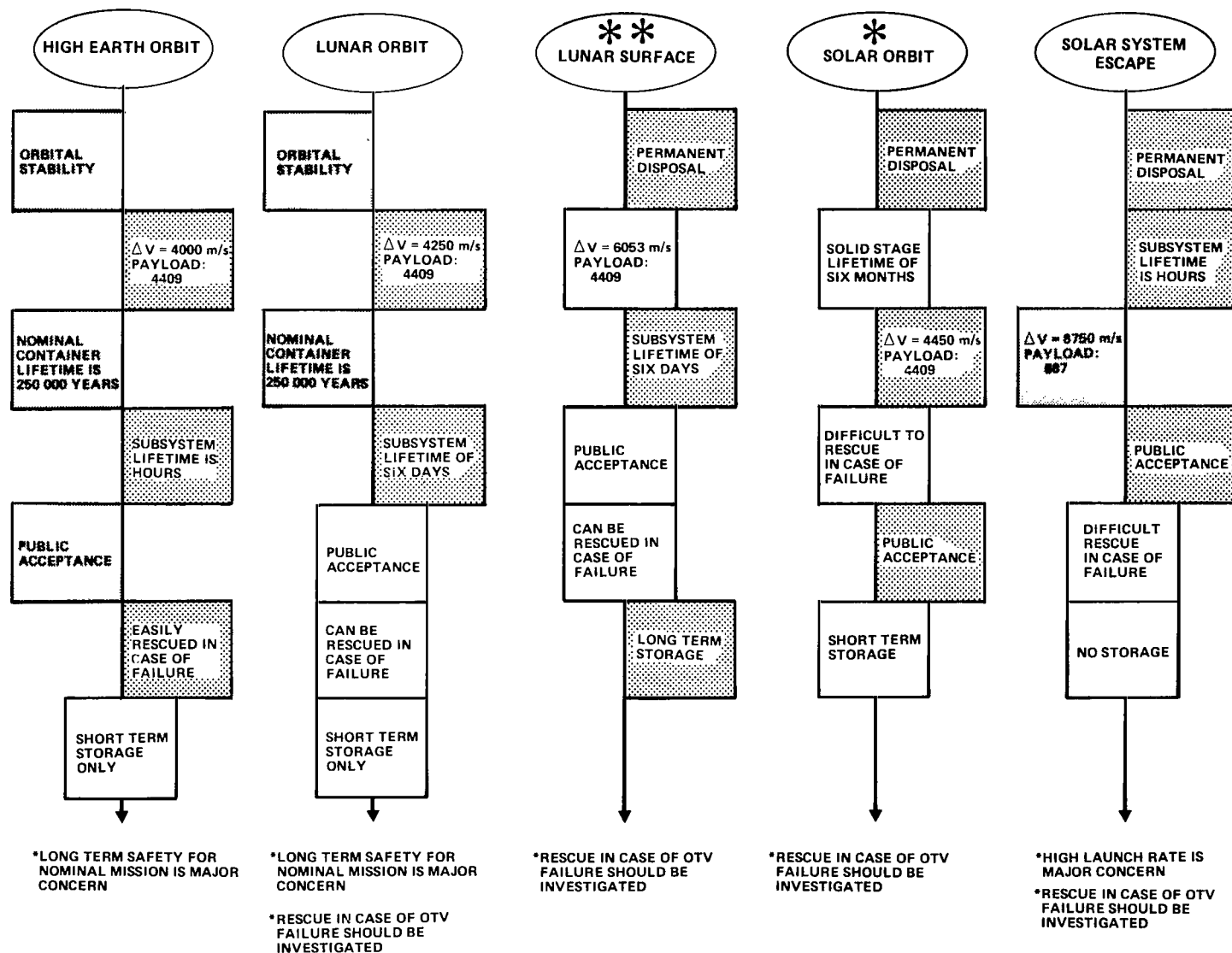

LEGEND: FLAGS TO THE RIGHT OF THE LINE ARE FAVORABLE.  
FLAGS TO THE LEFT OF THE LINE ARE UNFAVORABLE.  
FLAGS ON THE LINE ARE NEUTRAL.

Figure 5. Space options.



A failure during either of the OTV burns will leave the waste container in an Earth orbit from which the container can be retrieved by a rescue vehicle. After rendezvous and docking, the rescue vehicle can complete the mission by placing the container in the proper orbit. The inherent rescue capability that exists for the HEO mission is a plus for this option.

In addition to orbital lifetime, the other concerns associated with the HEO options are (1) the sheer number of waste containers (280 to 582 depending on the mix) that would add to the already cluttered Earth orbital space, and (2) the possible reencounter of the nuclear waste particles with the Earth due to the influence of the solar wind. It is most unlikely that a waste canister can be constructed that will last for the required 250 000 years. The canisters will erode with time under the influence of internal radiation as well as space encountered radiation, and the solar wind could drive the small particles back into the Earth's atmosphere. The dynamics of small particles under the influence of the solar wind is currently being investigated by Science Applications, Inc. Of all the space options considered, the HEO option would probably be the last one to gain public acceptance. The idea of several hundred nuclear waste containers orbiting the Earth is not an appealing one.

## **B. Lunar Orbit**

For a  $\Delta V$  of approximately 4250 m/s, the OTV in a reusable mode can place 4408 kg into a circular lunar orbit of radius 21 700 km. If this orbit is in the Earth/Moon travel plane, the result is an orbit that will exhibit orbital stability for extremely long periods of time. This type of lunar orbit has been analyzed using the "Surface of Section" method, and it was found that insertion errors of up to  $\pm 7200$  km in position and  $\pm 61$  m/s in velocity could be tolerated without affecting the orbital stability. Lunar orbit offers both storage and disposal options; however, retrieval of waste stored in lunar orbit is limited by the lifetime of the waste container.

The flight profile for the lunar orbit mission is more complicated than the HEO mission and will require three burns of the OTV main propulsion system plus a small plane-change burn (4 m/s) and a midcourse correction utilizing the Reaction Control System (RCS). The particular baseline profile that was selected has high performance and low near term risk of Earth encounter in the event of a system failure. Thus, for system failures, rescue can be performed with a standby vehicle. A perigee burn near the Earth provides over 90 percent of the delta-velocity required for translunar injection and places the OTV plus payload in a highly eccentric intermediate orbit. The major axis and eccentricity of the intermediate orbit is limited so that, in the event of total system failure after the perigee burn, lunar and solar perturbations [12] will not cause the OTV to encounter the Earth before a waste-recovery mission can be executed. Near apogee of the intermediate orbit, a plane-change burn is made to make the inclination of the OTV orbit compatible with the translunar targeting requirements. This plane-change burn can



also be used to raise perigee, thereby producing an even more stable orbit in the event of system failure after the plane-change burn. Burn 3 supplies the additional velocity to place the OTV within the lunar sphere of influence and near the desired close approach to the Moon. The OTV's state at the beginning of this burn is accurately known as a result of over 17 h of tracking and orbit determination since the plane-change burn. A midcourse burn may or may not be required. Burn 5 places the OTV plus payload in lunar orbit.

A propulsion system failure during the OTV perigee burn would leave the waste canister in a highly elliptic Earth orbit. Lunar perturbations, depending on the apogee radius, could be significant, thus rescue capability would be a requirement for this mission. A study was performed to determine the time required to perform a rendezvous with a failed OTV. The time required to perform a rescue mission will depend on the relationship of the failed OTV with respect to the position of the rescue vehicle at the time of launch. Table 5 presents data where the aforementioned relationship has been parameterized from  $0^\circ$  to  $320^\circ$ . The orbit considered for this analysis had a radius of perigee of 8222 km and a radius of apogee of 477 281 km. This represents an orbit with a larger apogee radius than would ever occur with the target biasing, as described earlier, and represents a worse case with respect to rendezvous time. As shown in Table 5, the worst rendezvous geometry occurs when the failed OTV plus waste canister is at  $240^\circ$  true anomaly when the rescue Shuttle/OTV vehicle is launched. Even in this case the time required for rendezvous is only 8.8 days. Thus, rescue of a failed OTV/waste package could occur easily before the lunar perturbation could have a significant affect on the orbit.

With time, it is possible that the canisters will erode away, and the small nuclear waste particles will be perturbed by the solar wind. This perturbation will possibly result in the nuclear waste impacting the Moon or even escaping the lunar gravitational field and reencountering the Earth. Due to large distance involved, only a small percentage of the particles should reach the Earth. This problem is being investigated by Scientific Applications, Inc.

### **C. Lunar Soft Landing**

Soft landing a nuclear waste canister on the lunar surface can be achieved with an expendable OTV for a  $\Delta V$  of approximately 6053 m/s. This mission has several advantages over the lunar orbit mission. First, the lunar surface can serve as a permanent disposal site or a long term storage site because the waste could be retrieved from the lunar surface, if ever it is desirable to do so, even if the containers erode away. Retrieval in such a case would require some form of collecting and repackaging the waste. Another advantage of this mission compared to HEO or lunar orbit missions, is that if the waste containers erode with time, the nuclear waste will be confined to the lunar surface and will not be left in orbit where the solar wind can possibly return some of the waste particles to Earth. The only way that waste could return to Earth from the lunar surface



TABLE 5. NUCLEAR WASTE RENDEZVOUS DATA

True Anomaly of Target When Inplane With Launch Site (deg)	Perigee Intersection Orbit Insertion			Phase Adjustment Orbit Insertion			Coelliptic Orbit Insertion			Rendezvous Terminal Phase Initiation Point	
	HA (n.mi.)	HP (n.mi.)	$\Delta V$ (m/s)	HA (n.mi.)	HP (n.mi.)	$\Delta V$ (m/s)	HA (n.mi.)	HP (n.mi.)	$\Delta V$ (m/s)	Total Time from Lift- off (day)	Total Tug $\Delta V$ (m/s)
0	915.4	94.2	392.5	47 799.6	906.0	2885.2	250 120	900.8	328.1	7.97	3605.8
40	915.0	94.2	392.3	48 042.1	905.6	2887.0	250 819	900.4	326.6	7.97	3605.9
80	914.6	94.2	392.1	48 954.6	905.2	2893.5	253 579	900.0	321.0	8.07	3606.6
120	914.7	94.2	392.2	48 789.6	905.3	2892.3	254 161	900.1	322.3	7.91	3606.8
160	914.7	94.2	392.2	28 539.9	905.3	2667.9	254 171	900.0	546.8	7.07	3606.9
200	914.7	94.2	392.2	72 847.1	905.4	3010.3	254 171	900.1	203.9	5.18	3606.4
240	914.6	94.2	392.1	47 078.3	905.2	2879.9	254 127	900.0	334.7	8.80	3606.7
280	915.0	94.2	392.3	48 828.4	905.6	2892.6	253 827	900.4	321.9	8.32	3606.8
320	915.3	94.2	392.4	48 672.8	908.9	2891.5	252 909	900.7	322.7	8.18	3606.6



would be as a result of meteoric impact, with some of the material achieving escape from the Moon and returning to Earth as a result of solar radiation pressure. The probability of the aforementioned happening is considered to be small; if it did happen, the amount of waste reaching the Earth would be very small.

The flight profile for the lunar soft landing mission would be very similar to flight profile previously described for the lunar orbit mission and is shown in Figure 6. The main difference would be that burn 3 would place the OTV on a lunar impact course.

Burn 5 would be a throttled burn which would soft land the OTV and the nuclear waste canister on the lunar surface. The OTV would strike the lunar surface in a near vertical, engine first position with near zero velocity. After impact the OTV would fall over and come to rest in a horizontal position on the lunar surface.

The lunar impact point can easily be adjusted to a large range of latitudes and longitudes with practically no  $\Delta V$  penalty. However, as the site is moved toward the Earth-Moon-Line (EML) or to the east of the EML, the downrange component of velocity becomes larger at impact. This fact implies that the effect of trajectory dispersion are larger to the east of the EML. Thus, choosing a landing site west of EML will tend to minimize landing dispersions and allow the nuclear canisters to be confined to a small area.

The impact commit burn is the most critical burn in the baseline trajectory profile. A premature termination of this burn could produce an unsafe orbit, with lunar and solar perturbations causing the OTV to encounter the Earth before a recovery mission could be executed. A premature termination of any of the other burns would not produce such a result. The best that can be done in designing the trajectory profile is to assure that only one burn is critical from the standpoint of an early termination. The impact-commit burn is targeted to produce an impact on the Moon at a steep angle of incidence to minimize the probability of missing the Moon in the event of a system failure following the burn.

The highly eccentric intermediate orbit that is produced by the long burn of 1120 s will be perturbed by lunar and solar gravity as shown in Figure 7 if the OTV is left in the intermediate orbit as a result of a system failure.

For the selected baseline trajectory profile and launch date, the intermediate orbit's line of apsides is favorably oriented with respect to the Earth-Sun line for the gradual raising of the perigee. An unfavorable orientation of the line of apsides would produce a gradual lowering of the intermediate orbit's perigee. By the proper selection of launch time and plane-change adjustment, a favorable orientation of the line of apsides can be obtained for a launch at any time of the year. A maximum rotation of the intermediate orbit's line of apsides of approximately  $45^\circ$  will "move" the Sun into a favorable position. This could be accomplished by waiting approximately 3.5 days.



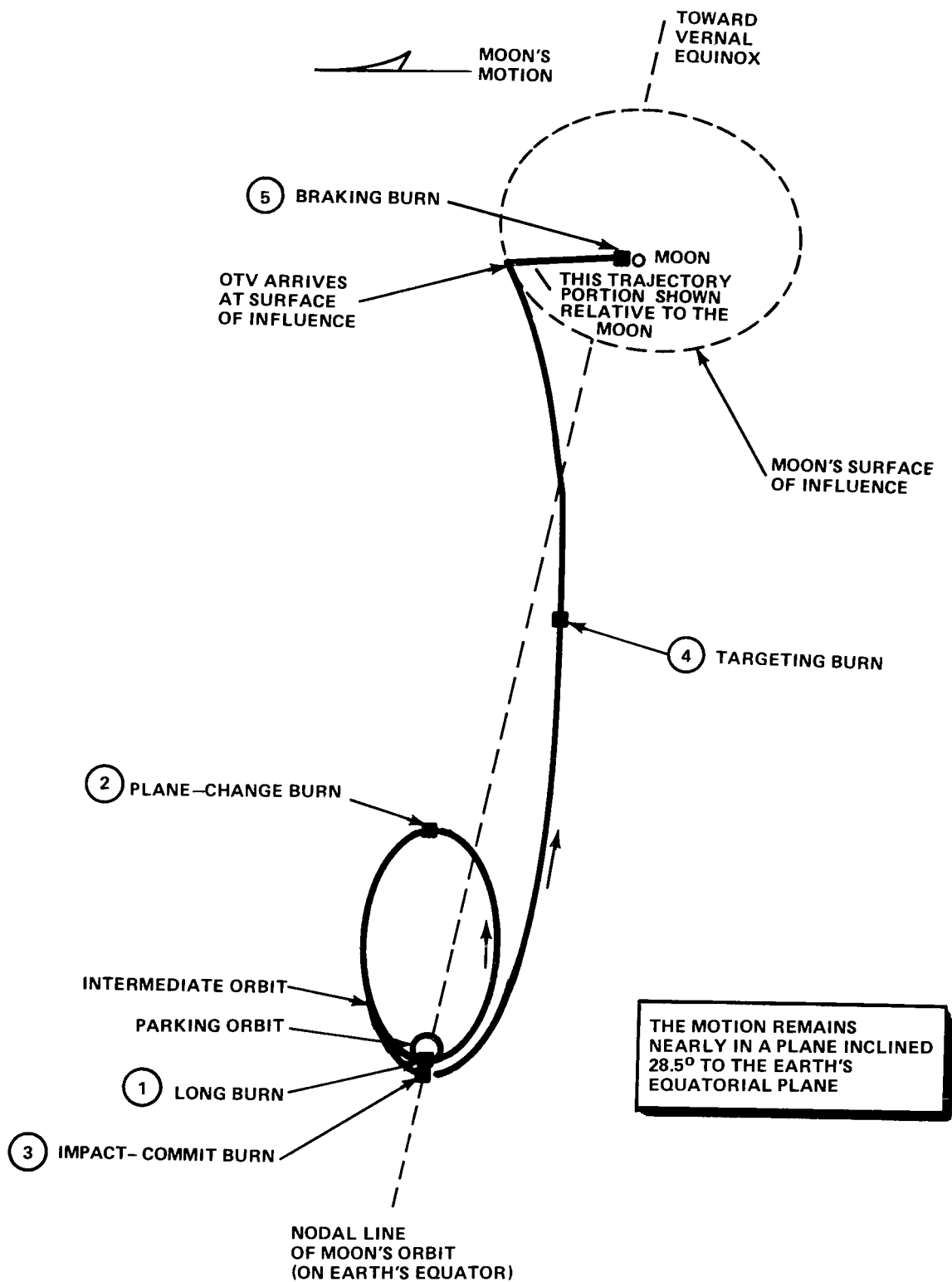

Figure 6. Flight profile for the lunar orbit mission.



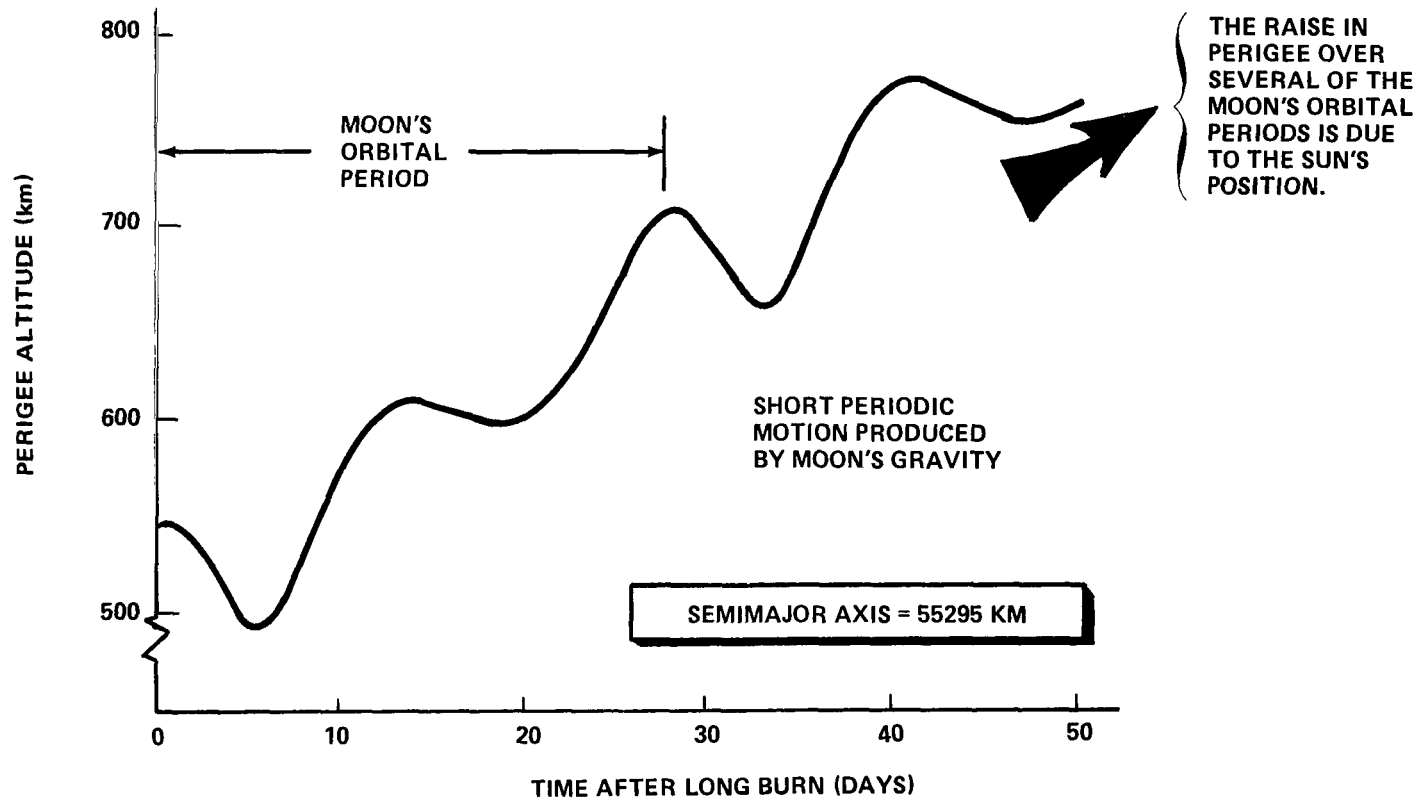

Figure 7. Perturbations produced by lunar and solar gravity on a highly eccentric immediate orbit.



The crater Billy, located at a longitude of  $50^{\circ}\text{W}$  and a latitude of  $-14^{\circ}$  was chosen as a preliminary disposal site. It is believed that this crater satisfies the conditions imposed by the preliminary reference trajectory and, at the same time, it is not near any other interesting lunar formations which might be explored at a later date.

#### D. Solar Orbit

Placing nuclear waste in an orbit in a region of space encircling the Sun, either outside or inside the Earth's orbit, would be a disposal option rather than a storage option, since for all practical purposes the waste could not be recovered. Retrieval would be expensive and would be limited by the lifetime of the canisters. Reference 13 presents data which indicated that a good choice for a solar orbit would be a circular orbit inside the Earth's orbit at 0.86 AU from the Sun. Figure 8 shows the long term variations in aphelion and perihelion and, as can be seen from this data, a 0.86 AU orbit demonstrates a high degree of stability. The  $\Delta V$  above the Shuttle orbit required to achieve a 0.86 AU circular orbit is 4450 m/s, and the OTV, in a reusable mode plus a kick stage can place approximately 4408 kg in this orbit. The optimal trajectory for this mission is a Hohmann transfer which requires a burn at perihelion and aphelion. These burns occur approximately 6 months apart. This would place a 6 month lifetime requirement on the solid motor kick stage subsystems, which will affect the overall vehicle reliability. A failure to make the aphelion burn or a failure during the latter portion of the perihelion burn will leave the nuclear waste canister in a solar orbit with a perihelion equal to that of the Earth. Thus, there would exist the possibility of the nuclear waste reencountering the Earth at some time in the future. Figure 9 shows the increase in  $\Delta V$  and the period of the resulting Earth-centered orbit as a function of OTV perihelion burn time. Earth escape occurs at approximately 1700 s, thus, a failure occurring during the first 1700 s would leave the nuclear waste payload in an Earth bound orbit while a failure after 1700 s would leave the waste in an elliptical solar orbit. In either case the payload would have to be rescued. Rescue in the latter case would be more difficult; however, there would be no immediate danger of reencountering the Earth. Thus, rescue would not have to be accomplished for several years. Data for Figure 10 was taken from Reference 14, and it shows the probability of Earth collision versus OTV/solid kick stage system failure rates. Earth collision risk results from vehicle failures which are caused by a premature termination of thrust, or a failure of the solid kick stage to ignite. The probability of Earth collision can be reduced by flying rescue missions. Standby vehicles could be used to rendezvous and dock with the nuclear payload, release the failed OTV or kick stage, and perform the necessary maneuvers to complete the planned mission. Note from Figure 10 that the probability can be reduced as low as desired by flying multiple rescue missions. Thus, the capability of rescuing a failed vehicle in heliocentric space should be a requirement for a solar orbit mission. An erosion of the canisters with time would release radioactive waste in heliocentric space. However, considering the vastness of space under consideration, the amount which could possibly return to the Earth would be very small. If the contents of one canister were dispersed at 0.5 AU and then swept out to 1 AU, the amount encountered by the Earth would be at most, much less than 1 gm [8]. Launch for a solar orbit mission is not constrained by a launch window.



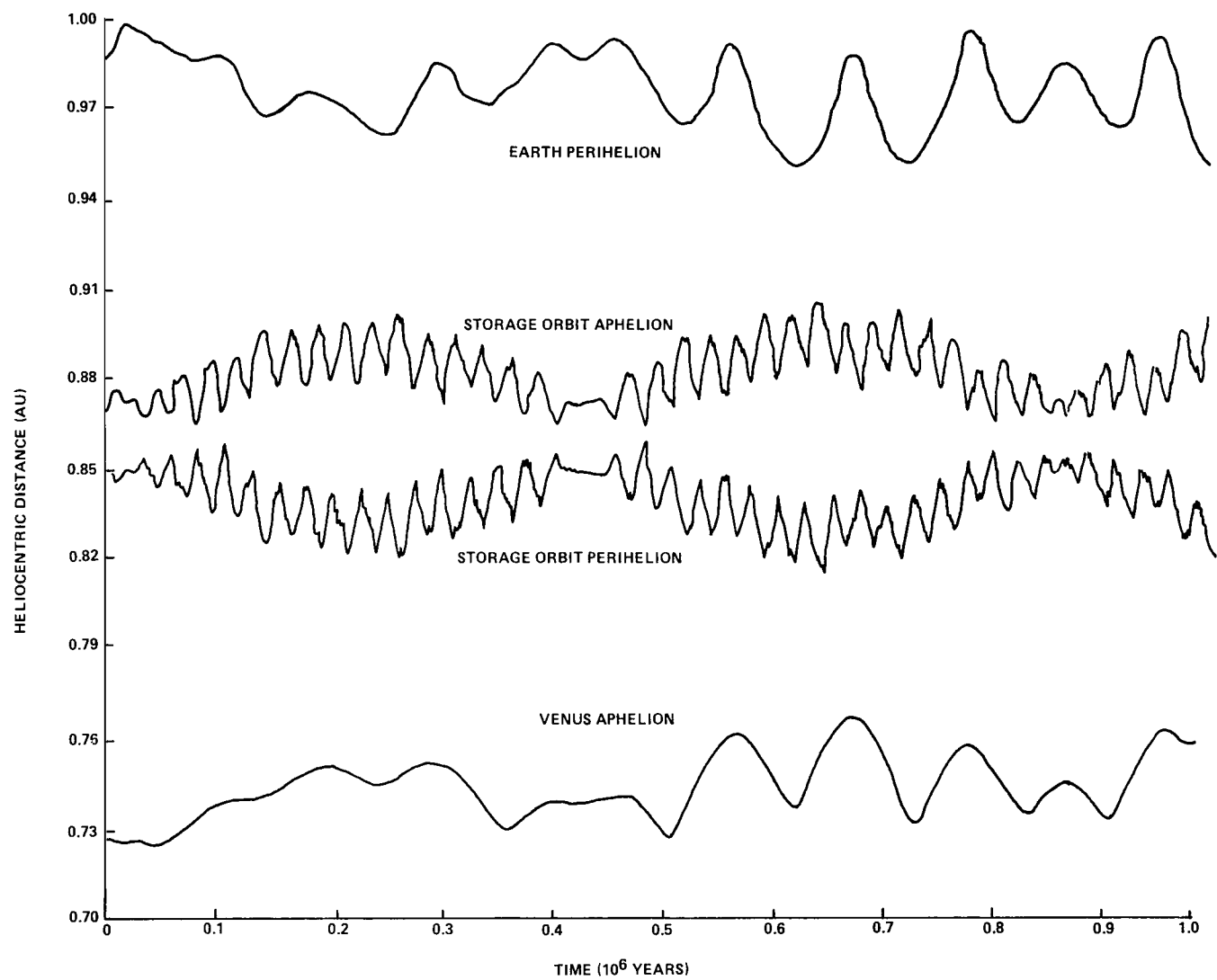

Figure 8. Long term variations in aphelion and perihelion.



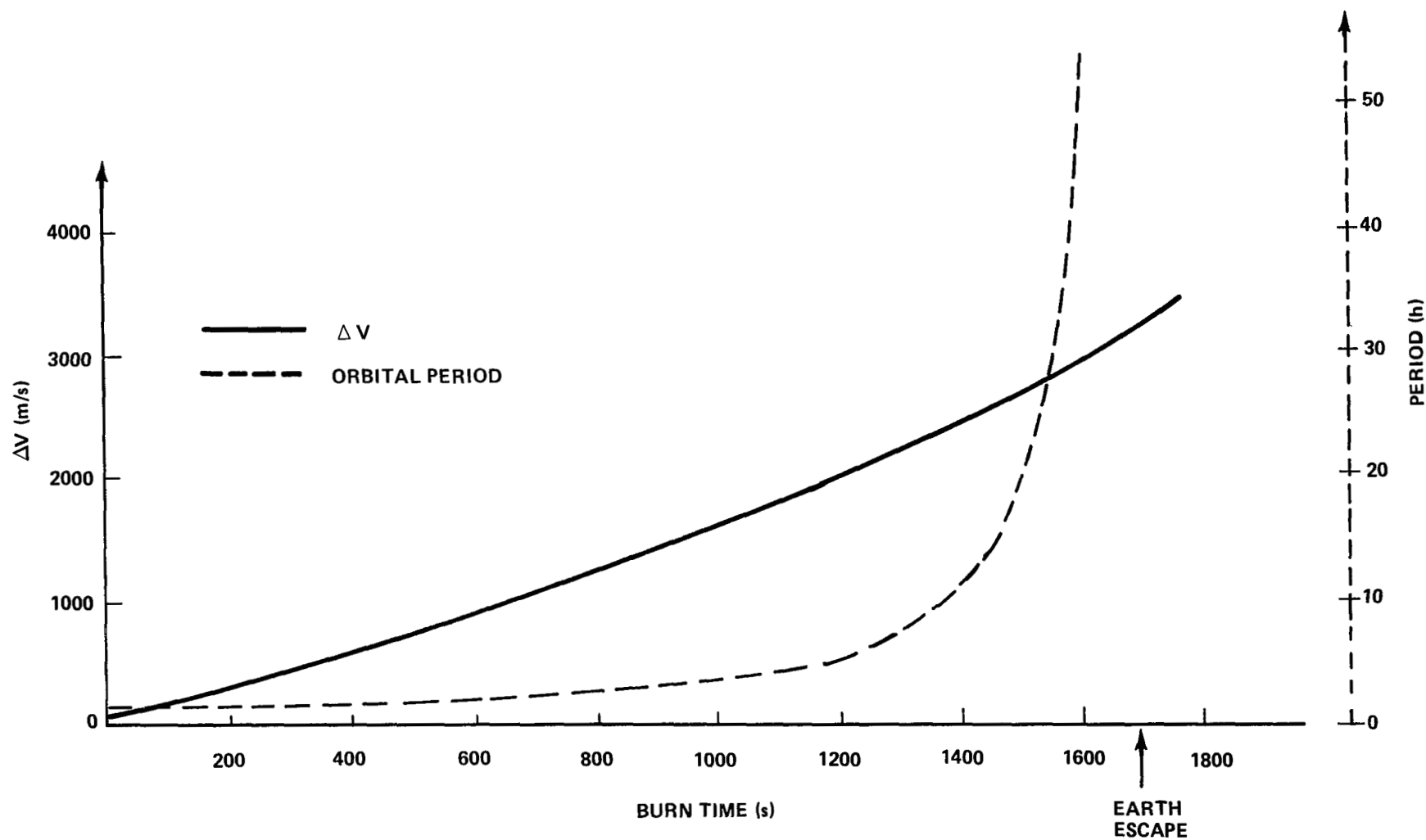

Figure 9.  $\Delta$  velocity and period versus OTV burntime for 0.86 AU mission.



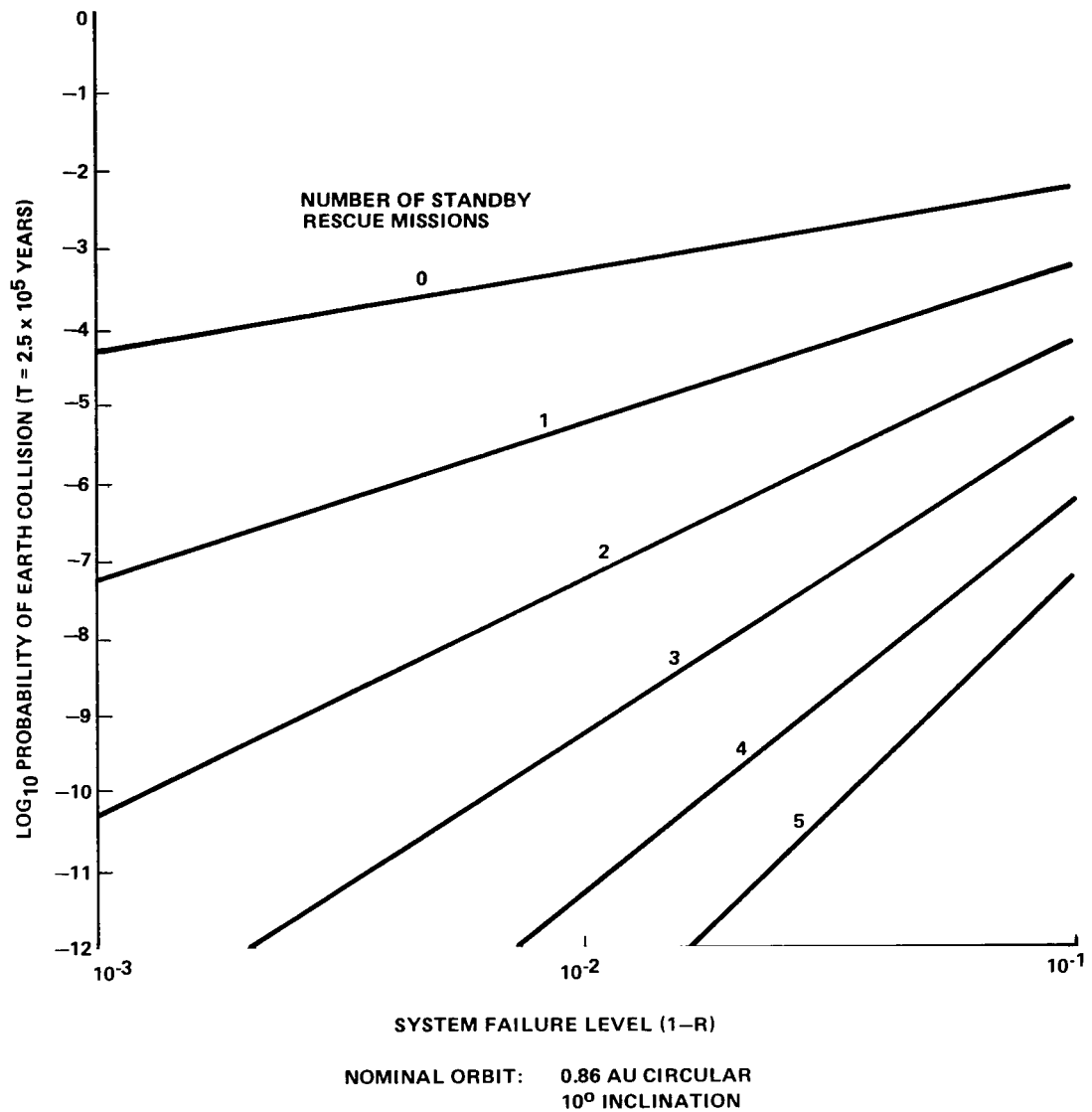

Figure 10. Risk profile for solar orbit disposal with retrieval.



### **E. Solar System Escape**

Sending nuclear waste to solar system escape guarantees permanent isolation from man's environment. It cannot be retrieved and, therefore, cannot be considered as a storage option. For a nominal mission, the mission is completed a few hours after launch with a single burn of the propulsion system; therefore, required vehicle lifetime is a minimum for this mission. Also, container lifetime does not present a problem, and there are no launch time restrictions. The major disadvantage to the solar system escape mission is the 8750 m/s  $\Delta V$  required. This high energy requirement limits the OTV's payload to 687 kg per flight. Also, a failure during the OTV burn could leave the nuclear waste in a heliocentric orbit with a perihelion of 1 AU. Figure 11 shows the increase in  $\Delta V$  and the period of the resulting Earth centered orbit as a function of OTV perihelion burn time. Earth escape occurs at approximately 1000 s, thus, a failure occurring during the last 800 s of the 1800 s burn time would result in a solar orbit from which rescue of the waste would be very difficult. The comments in Section D concerning the probability of Earth reencounter also apply to the solar system escape mission.

### **F. Solar Impact**

Sending the nuclear waste into the Sun also guarantees permanent isolation from man's environment. The previous comments concerning solar system escape generally apply to the solar impact mission. One major difference is that solar impact requires approximately 24 km/s  $\Delta V$ . This  $\Delta V$  is beyond the capability of current chemical propulsion systems, and a solar impact mission should be considered as impractical.

### **G. Space Option Comparison**

All six of the space destinations investigated have certain advantages and disadvantages. As mentioned previously, the mission scenario from launch to LEO is the same for all missions except for the launch rate. The HEO mission would have the lowest launch rate and the solar system escape mission would require the highest launch rate. The solar orbit and the solar system escape missions have an abort gap that occurs after Earth escape velocity is achieved. A vehicle failure during this time would leave the nuclear canister in a heliocentric orbit with a probability of reencountering the Earth within 250 000 years of  $10^{-3}$ . However, the probability of near term (10 to 20 years) encounter is extremely small, and more than adequate time is available for recovery of the waste canister. Flying one recovery mission with a reliability of 0.99 reduces the probability of encounter to  $10^{-5}$ , flying two (if necessary) recovery missions will reduce the probability of encounter to  $10^{-7}$ , etc. Thus, a proven heliocentric recovery capability should be a requirement for either the solar orbit or the solar escape missions. The main disadvantage to the solar escape mission is the high  $\Delta V$  requirement and consequent small payload.



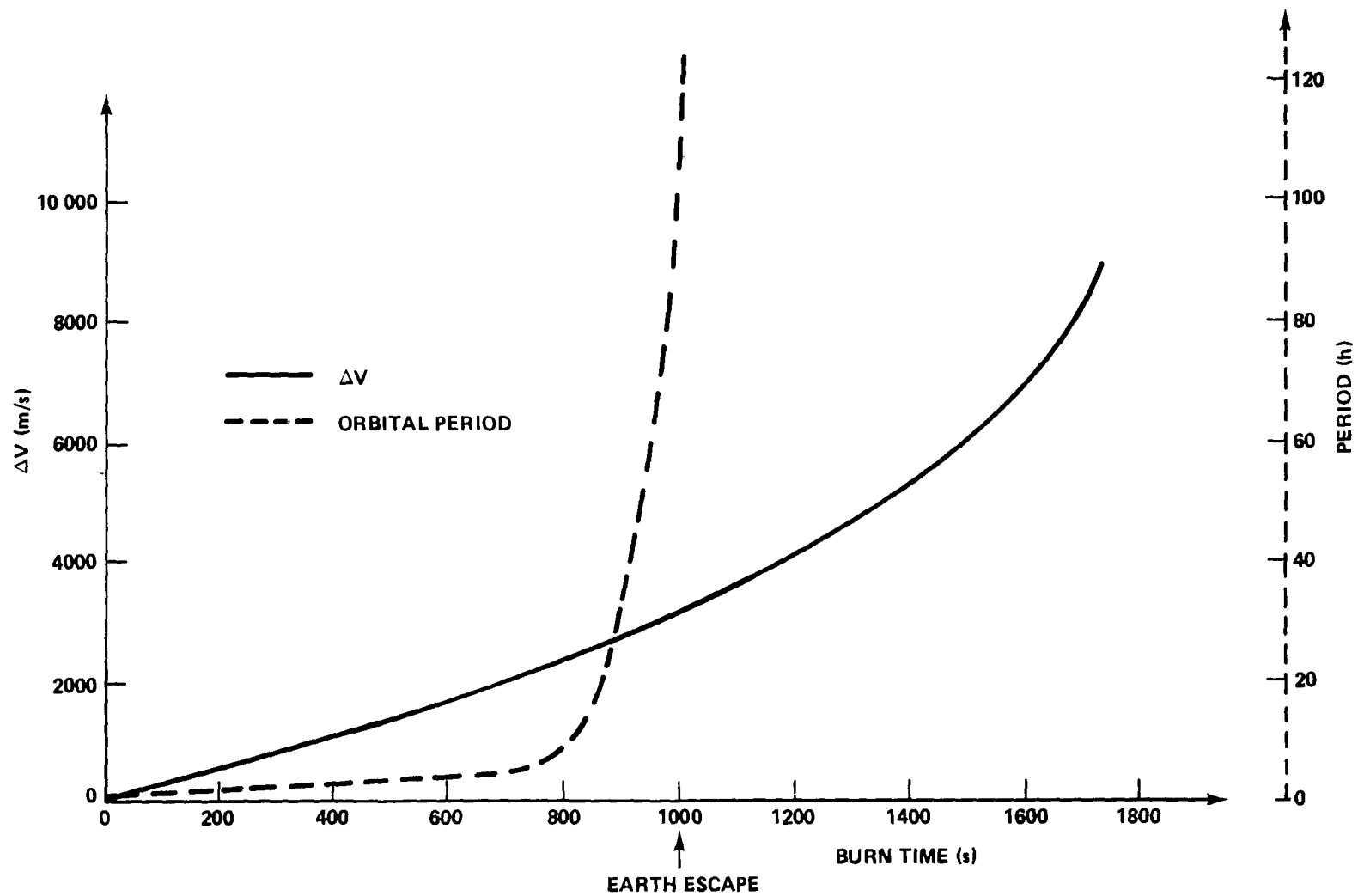

Figure 11.  $\Delta V$  and period versus OTV burntime for solar system escape mission.



The main concern associated with the HEO mission is the long term stability of the orbit. The effects of lunar and solar gravitational perturbations, the solar wind, and possible high altitude atmospheric drag make the HEO hard to assess. Eventual erosion of the canisters will leave the uncontained waste in Earth orbit, and the actual spread is difficult to predict.

The lunar orbit and lunar surface missions have potential upper stage failure conditions that could lead to non-nominal orbits that are sensitive to lunar and solar perturbations. Recovery capability would have to be demonstrated to protect against the rare but possible situation that results in orbits which are not stable for long periods of time. Studies have indicated that 10 days is sufficient time to perform a recovery mission.

Figure 5 represents a comparison of the five potential space destinations. Except for the small payload, the solar escape mission is the most attractive mission. However, overall the best options are (1) the lunar surface and (2) solar orbit.



## IV. NUCLEAR WASTE PACKAGING

The previous discussions on the waste mix and waste form have described problems that cannot be resolved (due to economic and technological constraints) by the waste form itself. The method of packaging the material can, however, economically substitute for shortcomings in the waste form.

The primary residual problems are thermal conductivity and dispersion in the case of waste oxide and a simple containment in the case of the metal matrix. Since the initial baseline was oxides (the metal matrix was "discovered" more recently), several compensatory designs were evolved which allowed the use of pure oxide mixtures. For this reason, such packaging is described with the understanding that it is an "overkill" for the metal matrix.

### A. Waste Canister

The waste canister is the innermost wrap for nuclear waste and, therefore, must be made of a material which is chemically compatible with the waste oxides of either Mix 2 or Mix 3. Niobium was chosen as the metal because it is rather light (mass density of  $8.57 \text{ gm/cm}^3$ ) and has a high melting point ( $2468^\circ\text{C}$ ). It is also rather resistant to attack, although an oxidizing environment such as is envisioned is not acceptable. Prior NASA work on the use of niobium as a reentry shield developed silicide coating techniques for the metal that makes it virtually impervious to oxygen attack. Thus, it seems to be an acceptable material.

The thickness of this particular portion of the container is important because, as will be discussed later, all niobium which is carried subtracts an equal amount from the payload. This dictates that the thinnest possible shell of niobium be used, and a value of 0.625 cm was chosen. It should be noted that this shell is not to withstand pressures.

At this time, an assumption must be made as to the amount of waste that is to be carried on a given mission. The systems interaction is such that the amount chosen cannot yet be justified; it will be derived in Section VIII, based on the packaging assumptions made here. A nominal value of  $1 \text{ m}^3$  of waste oxide is chosen as the payload.

Another look ahead is also required. The waste canister must be wrapped in a gamma ray shield as well as a mechanical protection wrap (see Sections IV.B and C). These additional wraps around the canister will add a very large amount of mass to the overall system, and all of this mass must be transported to space. For this reason, it becomes extremely important to shape the basic canister in such a way that the required additional packaging is at a minimum.



Two configurations were seriously considered: the right circular cylinder and the hemisphere. The right circular cylinder must be further specified by a fineness ratio, i.e., the ratio of length to diameter. It is obvious that a very long pencil-like cylinder or a very flat pancake-like cylinder would provide relief for the low conductivity of the waste oxides since only a short path would be required before the heat would emerge from the package for dissipation by some chosen means. Both of these configurations would require excessive weight for the subsequent shielding and are therefore unacceptable. Minimum shield weight will occur for a fineness ratio of 1.0; this effect is so important that such a fineness ratio was baselined.

The remaining problem of thermal conductivity was first approached by dividing the waste into 19 small cylinders which were folded into a hexagonal configuration. A hexagon can be formed from only certain numbers of cylinders ( $\approx 3n^2 + 3n + 1$ ) and for this study 19 cylinders were chosen. One cylinder was reserved for mechanical reasons, and the nominal waste was separated into 18 equal parts. This left a rather short heat flow path from the center of the cylinder to the wall of the cylinder. The folded cylinders approximated a right circular cylinder of fineness ratio 1 (Fig. 12).

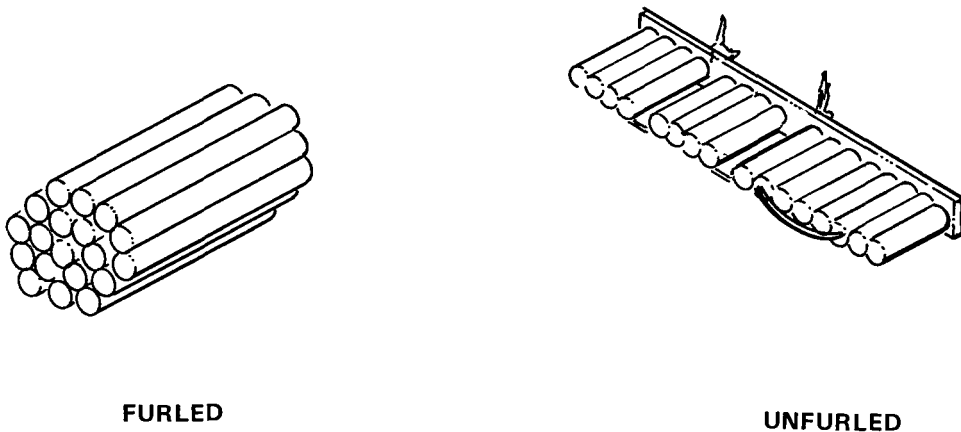

Figure 12. Hexagonal packaging configuration.

Heat is now removed from the hexagonal configuration by several means, depending upon where the package is in transit. During ground operations and ascent to orbit, cooling was to be accomplished by coolant flow through the holes between the cylinders. A similar cooling method would occur in case of a catastrophic abort when the package is in the ocean. For on-orbit operations and transfer to the ultimate destination, the 19 cylinders were to be mechanically unfurled and the heat dissipated to space via radiation.

The prime difficulty with the hexagonal-cylinder concept is that a mechanical system must operate to achieve cooling on orbit. Where motion must occur a potential failure mechanism exists. To simplify the mechanism, another concept involved packaging



the waste into two annular cylinders and one solid cylinder. During periods of active cooling (ground operations, ascent, and after a catastrophic abort), coolant flows through annular spacings between the cylinders. On orbit the telescoping package is simply pulled into a deployed condition for radiant cooling (Fig. 13).

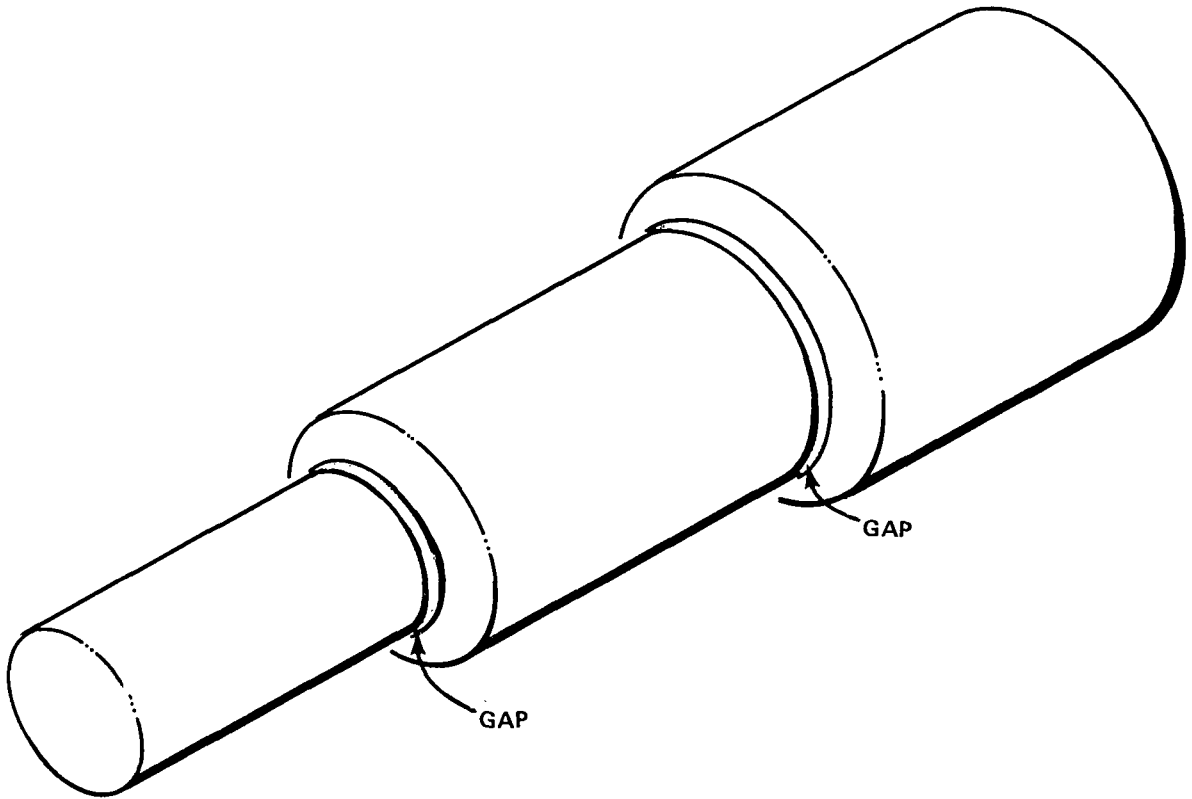

Figure 13. Telescoping package configuration.

Although the second mechanism is simpler, it is still a system that must operate. For this reason, it is desirable to develop a solid package that meets thermal constraints. This was done by assuming that a nominal cubic meter of waste is packaged into a right circular cylinder with a fineness ratio of 1 and then, in theory, inserting highly conductive fins into the waste. This shortens the distance that heat must flow before emerging from the low conductivity oxides. The finning may be added in many ways, but two configurations were studied: radial finning and finning orthogonal to the axis of the cylinder (Fig. 14).



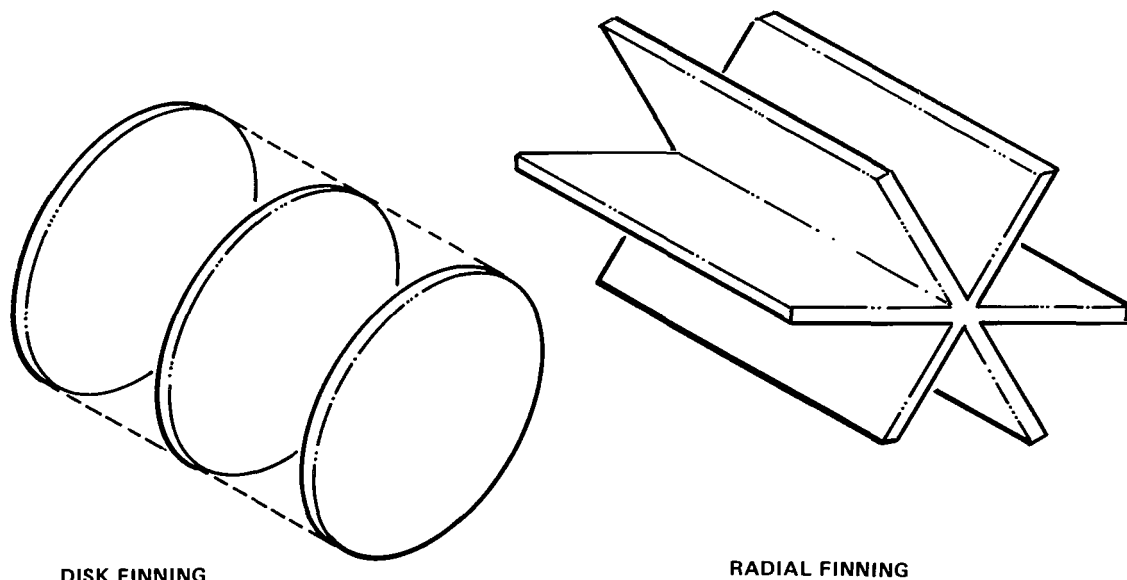

Figure 14. Radial and orthogonal finning concepts.

Quantative work is required to determine the actual temperature distribution within the waste. Although the classic work of Carslaw and Jaeger [15] can be used to approximate the case in which the fins are orthogonal to the axis, real physical conditions require a much more sophisticated treatment. The finning material, for example, is of finite conductivity, therefore, trivial boundary conditions are inapplicable (i.e., the temperature gradients along the fins are significant). Furthermore, the conductivity of the chosen finning material (pyrolytic graphite) is anisotropic as well as temperature dependent.

Two numerical programs were developed to study the temperature distribution within the package. The program used to study the case in which the finning is orthogonal to the axis cylinder [8], though approximate, indicates that centerline temperatures of approximately  $1000^{\circ}\text{C}$  are readily achievable.

A second program which utilized radial finning was developed at MSFC for quick-look analog analysis. Again it is found that acceptable temperatures are achieved in the waste. The temperatures are a strong function of the spacing of the fins and the fin thickness. Figure 15 illustrates this point.

The second major configuration to be studied was that of oxides in a hemispherical container. The hemisphere has several advantages over the right circular cylinder. Since a cylindrical shape would be expected to have approximately 16 percent more surface area than the hemisphere (for a given volume), some saving in shield weight would be expected to accrue. Additionally, the hemisphere lacks leading "corners" that could be points of stress concentration during times of impact. Finally, a hemispherical configuration can more readily be extracted from outer shielding on orbit.



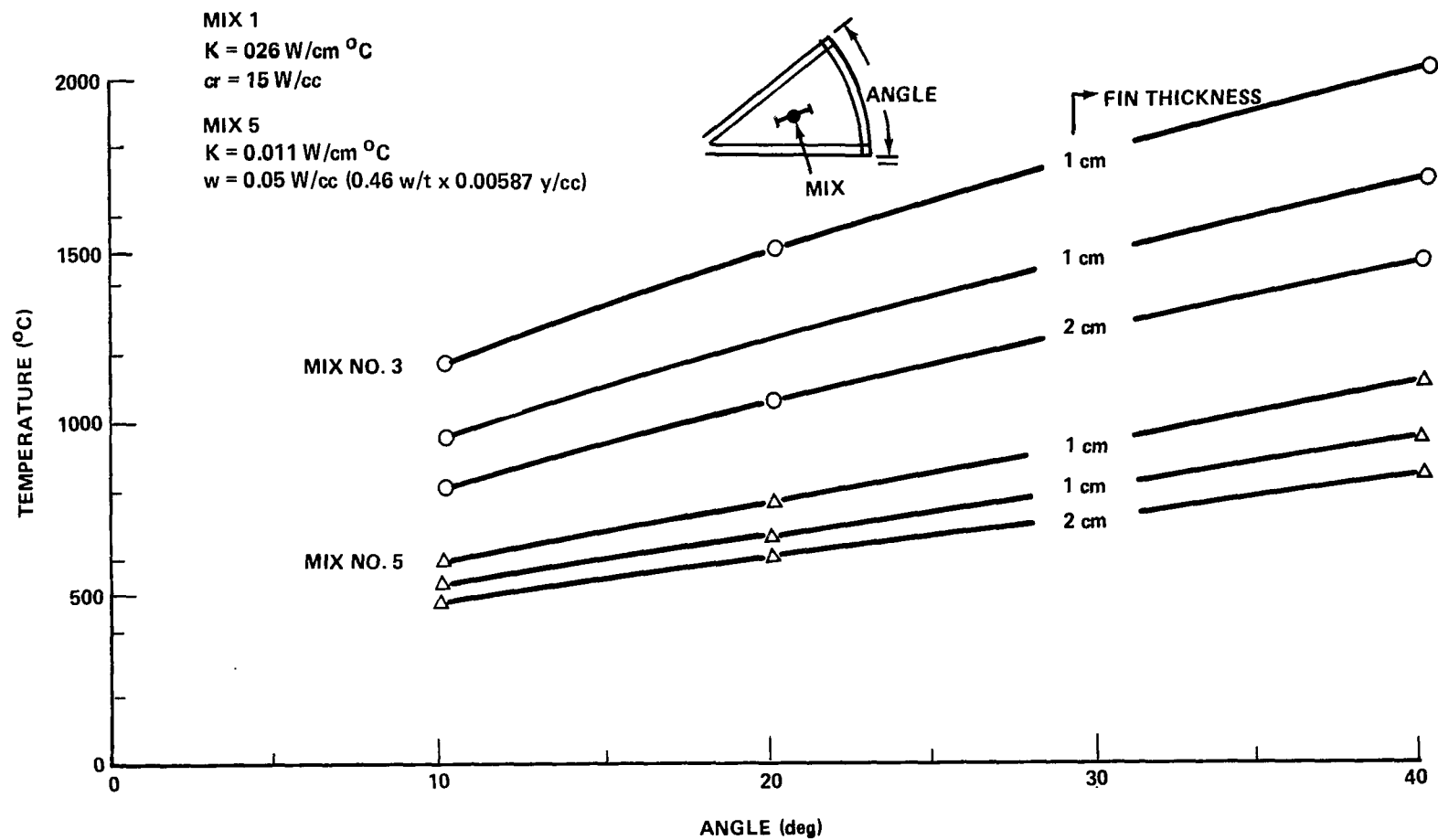

Figure 15. Nuclear waste maximum temperature versus angle between fins at various fin thicknesses.



The prime disadvantage of the hemisphere is that it presents a difficult packaging problem when the waste must be densified at the packing stage.

It is possible to fin the package in either of two radial directions. This is most readily envisioned by thinking of an orange (the edible fruit). In one case the orange is sliced along the equator and the orange slices represent waste cells. In the second case the orange is sliced in a plane through the poles — again the orange slices represent waste cells. Due to modeling considerations, the second configuration was developed for study. This model is quite extensive and accounts for a level of detail which includes contact resistances, anisotropic conductivities, surface radiation equilibrium, etc. That is, it is a first class model that gives results with a high degree of confidence. The results of this model (again demonstrating the validity of finning) is described in Reference 13.

The modeling thus far demonstrates that there are a number of compensatory designs which allow the use of waste oxides. The metal matrix, which represents future work that has yet to be developed has not been discussed. Quick estimates indicate that finning is totally unnecessary for the matrix since the conductivity is inherently high in that case. If the temperature at the hottest spot is described as temperatures due to a gradient through the waste plus a surface temperature of the waste, then a high waste conductivity only lowers the gradient component. The limit for waste centerline temperature occurs for infinite waste conductivity because (in space) all heat must be radiated through a surface that encloses  $1 \text{ m}^3$  of waste.

With a waste mass density of  $4.0 \text{ gm/cm}^3$ , an emissivity of 0.95, and assuming that radiation cooling occurs from the curved portion of the hemisphere, the limiting temperature is  $652^\circ\text{C}$  for Mix 2 and the limit is  $610^\circ\text{C}$  for Mix 3.

From the preceding discussion, for either Mix 2 or Mix 3 the following recommendation can be made:

The innermost waste package shall be a niobium hemisphere containing a nominal volume of  $1 \text{ m}^3$  of waste. If oxides are used, pyrolytic fins are added. In the case of a metal matrix, finning is not required.

## **B. Radiation Shield**

The waste package must be adequately shielded to protect the ground crew, the Orbiter crew and, in the case of the highly improbable event of catastrophic launch vehicle failure, people in the area of Earth impact. Calculations were performed to determine the gamma shielding requirements for containers of nuclear waste. The contribution to the radiation dose due to neutron flux was not taken into account.



1. Requirements and Assumptions. Radiation shields designed for use in space transportation of nuclear waste must be as light as safety aspects will allow. A computer program, SDC [16], obtained from the Radiation Shielding Information Center was used to design the gamma shields. Shields were designed for three waste package concepts;<sup>5</sup> (1) a hexagonal package with 19 cylinders, (2) a finned cylinder, and (3) a finned hollow hemisphere. The design dose rate for the shields is 2 rads/h at a distance of 1 m on all sides of the package and 0.1 rad/h at the Orbiter crew compartment. It was determined that 2 rads/h at 1 m is a more stringent requirement than 0.1 rad/h at the crew compartment. A conservative assumption was made that the reentry protection system (>3.8 cm of steel on all sides) would provide no shielding.

A copy of ORIGEN output, obtained from Oak Ridge National Laboratory (ORNL), was used to estimate the radiation source term for this study. The design basis fuel is PWR-U which is irradiated for 3 years to a burnup of 33 000 MWD/MT, reprocessed 0.5 year after discharge, and stored for 9.5 years after reprocessing. The gamma source strength for Mix 3 (Section II) is shown in Table 6.

2. Design Technique. In order to maximize payloads, the shield weight should be minimized. The shields for the hexagonal package with 19 cylinders and the finned cylinder were optimized by determining the shield thickness required at each point along the waste package and designing the shield to these specifications. The shields, hexagonally shaped for the 19 cylinder configuration and cylindrical for the finned cylinder, were found to have a thickness that may be represented by a quadratic equation. This means that shield thickness can be represented as  $a + bX + cX^2$ ; where X is the distance from the bottom of the waste package to any point along the package length. a, b, and c are constants which are different for each mass of waste, density of waste, and shielding material. The top and bottom of the shields were considered to be of constant thickness and equal to the  $X = 0$  thickness of the shield sides. The hollow hemispherical configuration shield thickness was computed by approximating the hemisphere as a sphere with the same radius, waste mass, and photon spectrum. The hemispherical shield is assumed to have a constant thickness. Figure 16 depicts a typical shield for the cylindrical or hexagonal package, and Figure 17 depicts a hemispherical shield. Cladding about the shield is to prevent oxidation of the uranium alloy.

3. Gamma Shield Material, Waste Density, and Neutron Shield Considerations. Four materials (iron, lead, tantalum, and uranium) were investigated as possible candidates for use as waste package shielding. Uranium, per se, would probably not be the shield material (a uranium alloy would probably be used); however, buildup factors and attenuation coefficients of uranium were used to approximate the alloy in this study. In addition to the actual shielding, niobium was used as a containment wrap for the

---

5. The term "finned" in this context means graphite vanes are inserted into the nuclear waste mix.



TABLE 6. PHOTON SOURCE STRENGTH (10 years)

E Mean (MeV)	Source Strength (Photons/s/MT of Heavy Metal Charged to the Reactor)
0.3	$1.70 \times 10^{14}$
0.63	$3.87 \times 10^{15}$
1.1	$1.32 \times 10^{14}$
1.55	$9.19 \times 10^{12}$
1.99	$9.58 \times 10^{10}$
2.38	$2.57 \times 10^{10}$
2.75	$2.01 \times 10^9$
3.25	$6.38 \times 10^7$

waste because it has a high melting point, a reasonably low density, and is a rather inert metal. Buildup factors and attenuation coefficients for iron were used to represent niobium.

Shields were designed for three mixes with assumed waste densities ranging from 3 to 6 gm/cm<sup>3</sup>. Shields were designed for 3000 kg of Mix 3, density 5 gm/cm<sup>3</sup>, in the 19 cylinder hexagonal configuration using each of the four shield materials. Table 7 presents the results of this exercise. The uranium shield weighed much less than the other materials; therefore, it was selected as the primary candidate for use as a shield material. Tantalum, due to its structural and thermal properties, was also considered in some detail. Figure 18 presents curves of shield weight versus weight of the waste in the 19 cylinder configuration for uranium and tantalum shield materials and waste densities of 4, 5, and 6 gm/cm<sup>3</sup>. As can be seen from this figure, density of the waste is a very important factor in shield weight; therefore, it is imperative that the waste be compacted as much as possible.

Although radiation dose due to neutron flux was not taken into account, the study did consider the weight change in the shield when neutron shielding was included. The neutron shield was arbitrarily picked as 5 cm or 10 cm of lithium hydride enclosed in 0.375 cm thick stainless steel. Figure 19 presents a graph of shield weight versus waste weight for Mix 3 with and without neutron shielding. The shield weights for this graph were computed for the finned cylinder configuration. Neutron shielding of 5 cm for 4000 kg of waste increases the total shield weight by approximately 2000 kg. This is not, in itself, a show stopper; however, it is a considerable penalty.



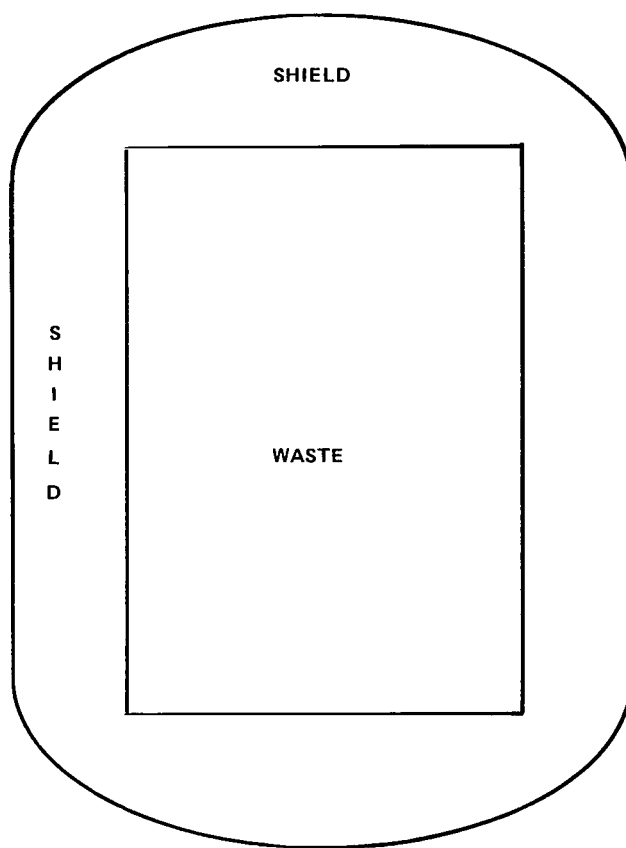

Figure 16. Typical shield for the cylindrical or hexagonal package.

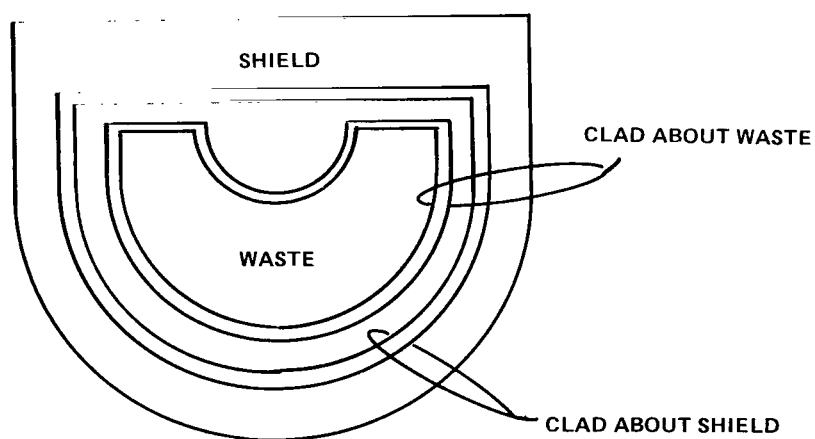

Figure 17. Typical shield for the hemispherical shield.



TABLE 7. GAMMA SHIELD MATERIAL REQUIREMENTS

Shield Requirements				
2000 mrad/h 1 m from shield 3000 kg, Mix 3, density 5 gm/cm <sup>3</sup> Waste				
Shield Material	Atomic Number	Density (gm/cm <sup>3</sup> )	Melting Point (°C)	Shield Weight (kg)
Iron	26	7.87	1535	14 000
Tantalum	73	16.6	2850	10 330
Lead	82	11.34	327	9 010
Uranium	92	19.0	1133	8 210

4. Hollow Hemispherical Configuration Shielding. The hollow hemispherical configuration is, at this time, the preferred configuration; therefore, the traffic analysis (Section VIII) is computed assuming uranium shield weights for the hemispherical configuration with a waste density of 4 gm/cm<sup>3</sup>. Figures 20 and 21 present information about the shields for this configuration. Shield weight versus waste weight (waste density = 3, 4, and 5 gm/cm<sup>3</sup>) is presented in Figure 20 for Mix 3. This figure emphasizes that shield weight is a function of density of the waste. Figure 21 shows shield weight (density = 4 gm/cm<sup>3</sup>) for Mixes 3, 5, and 5A. The shield design presented herein should be considered preliminary, thus there remains a tremendous amount of work in this area that must be performed in future studies. Some of the areas requiring additional work are: (1) shield material, (2) neutron shielding (is it necessary, and, if so, what material), (3) effects of secondary gammas, and (4) design dose rate.

### C. Mechanical Containment

The third important component of the nuclear waste package is the mechanical containment; this is the primary safeguard against release of the waste material.

The first two components of the package, the canister and the gamma shield, fit inside the mechanical containment shell. Although the canister will be removed on orbit (and must therefore not be rigidly attached to the gamma shield), there appears to be advantages to a direct attachment between the gamma shield and mechanical containment shell.



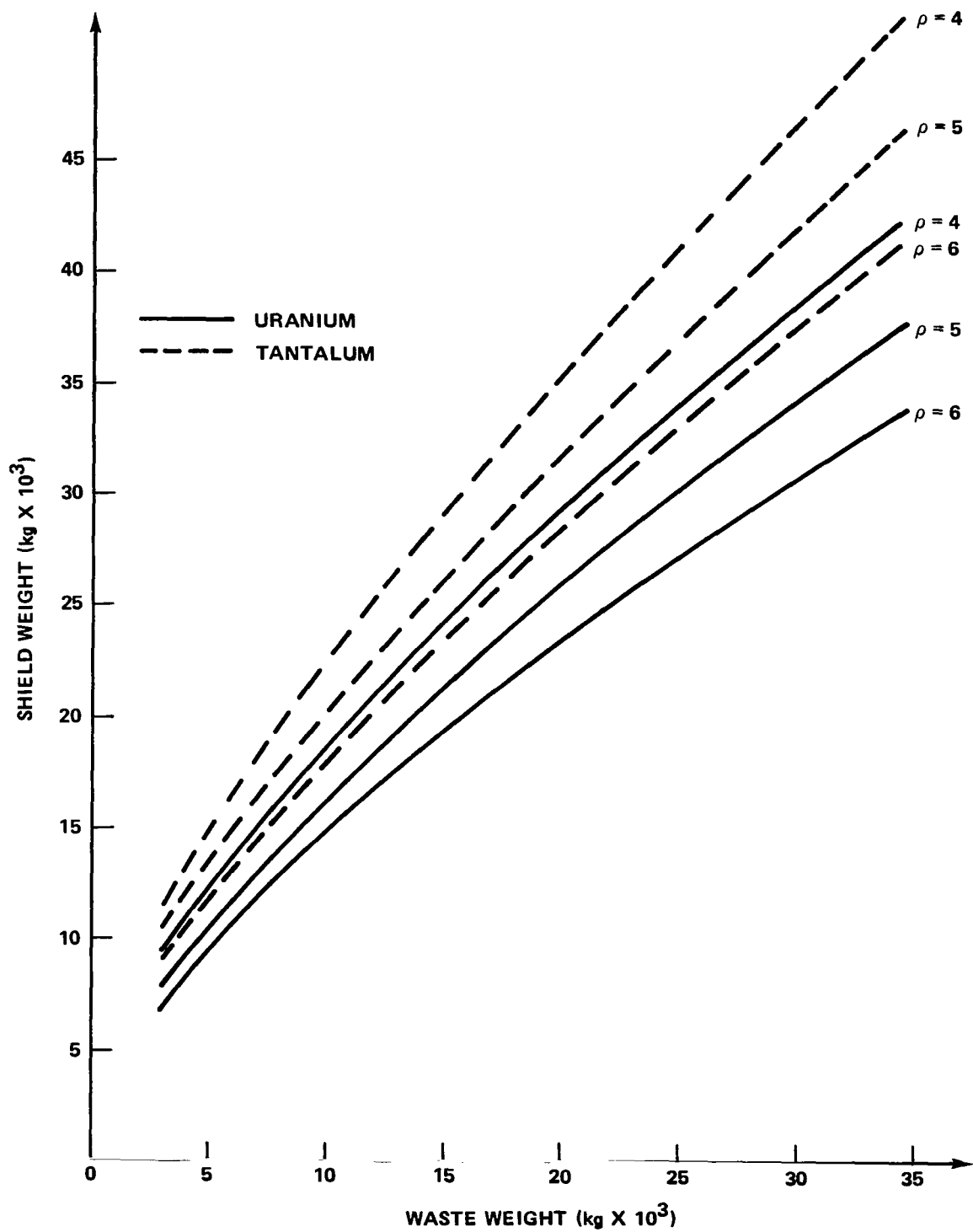

Figure 18. Shield weight for 19 cylinder configuration.



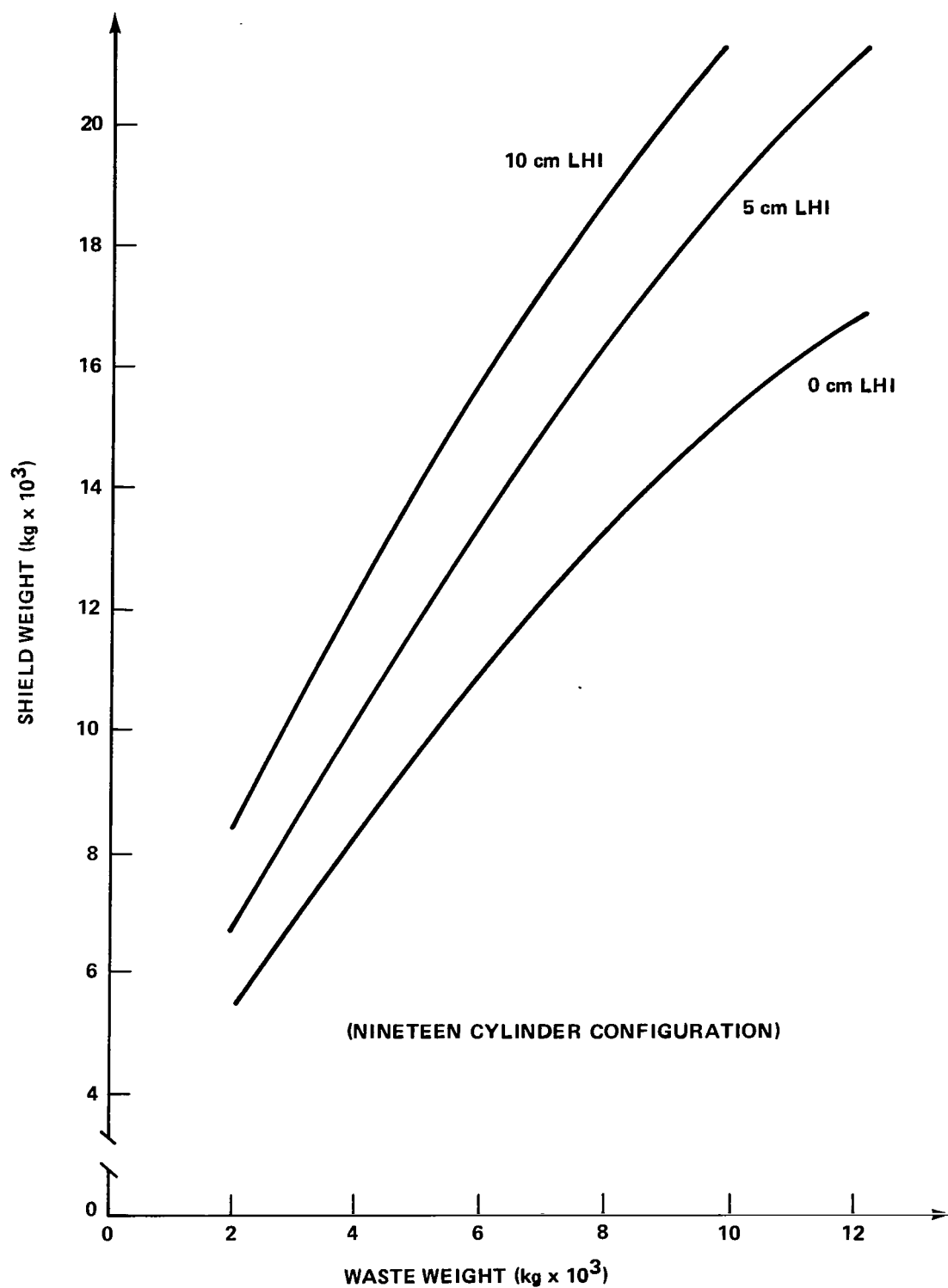

Figure 19. Neutron shielding effects.



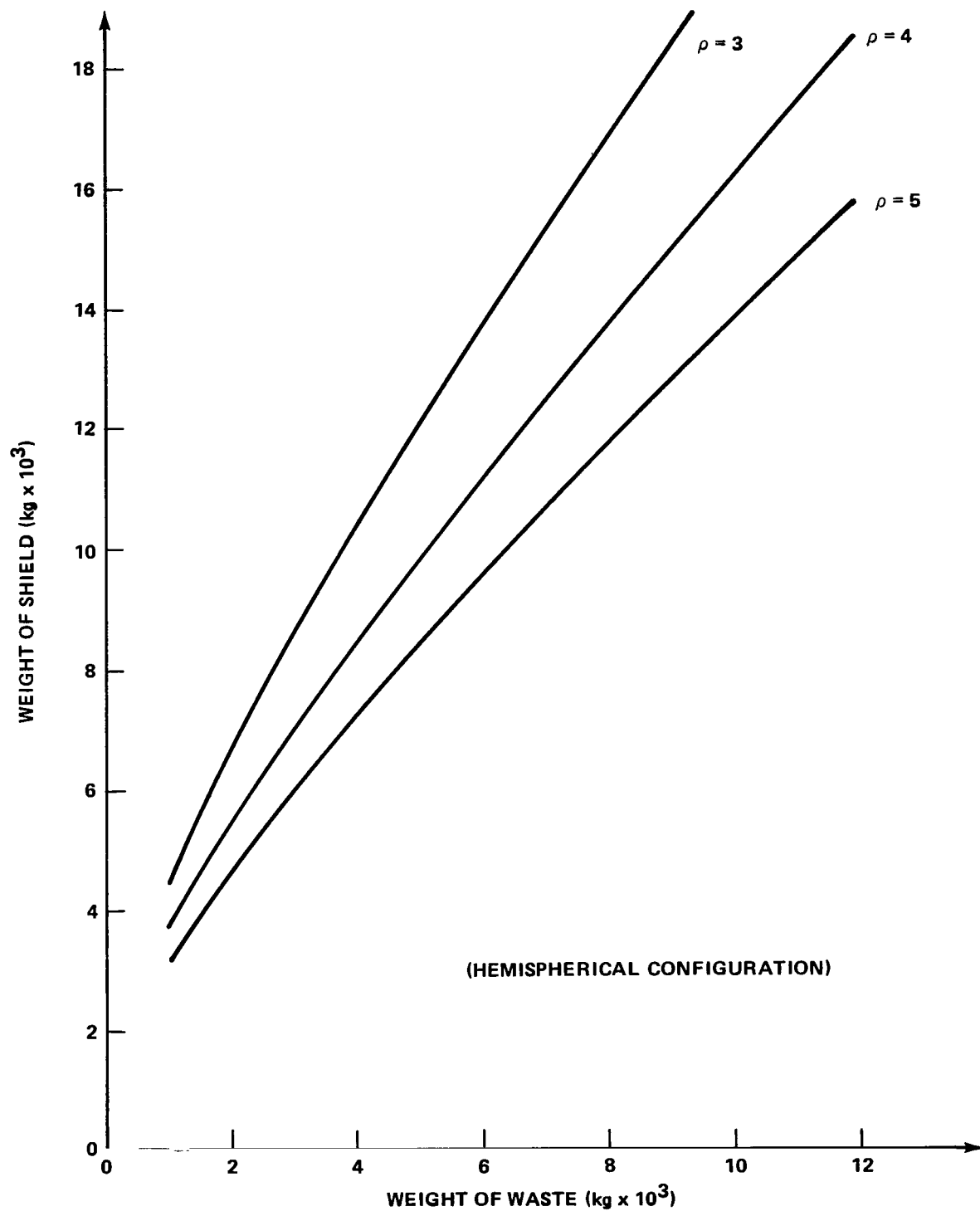

Figure 20. Shield weight as a function of waste density.



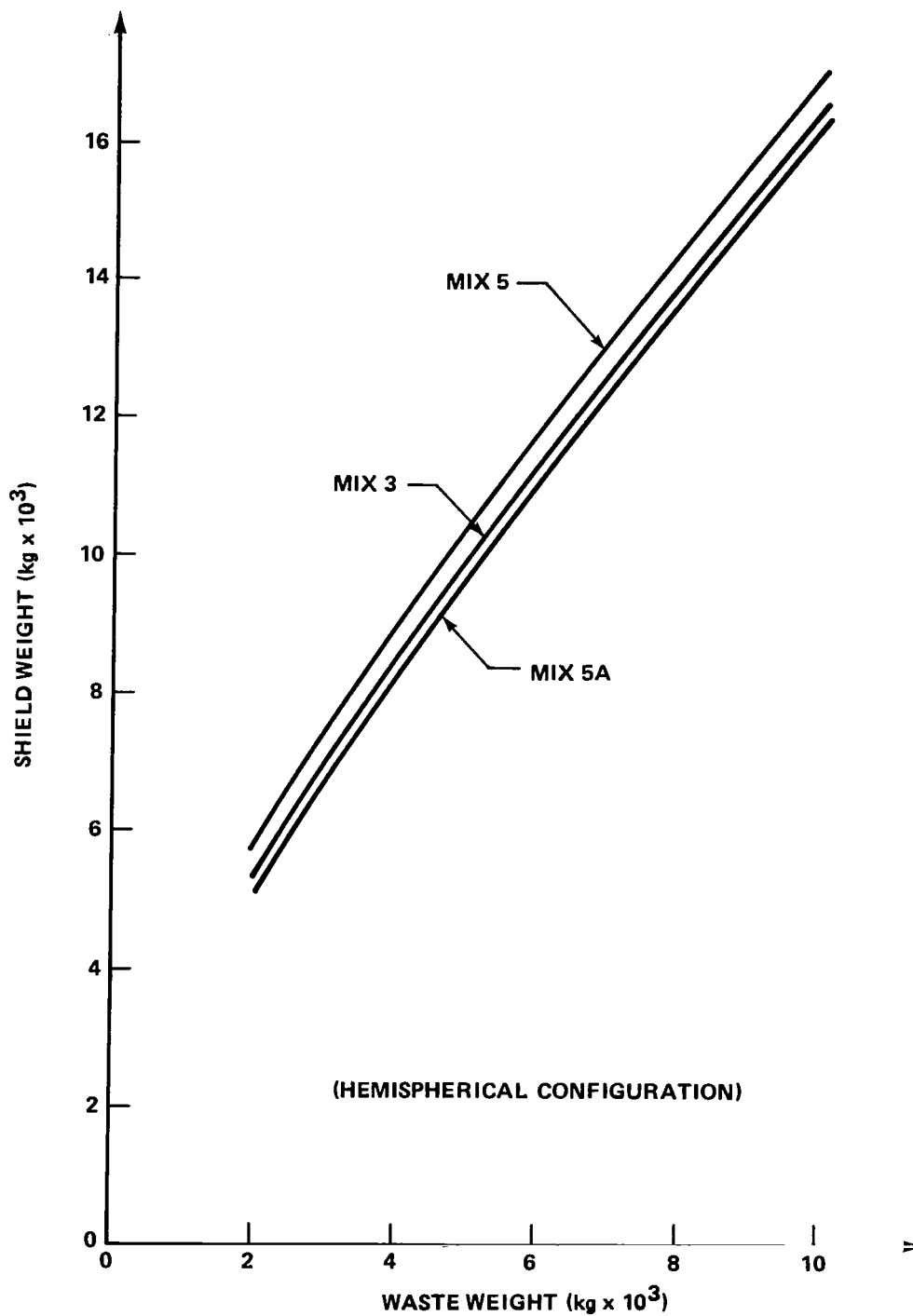

Figure 21. Shield weight for the different mixes (waste density =  $4 \text{ gm/cm}^3$ ).



The shielding effect of the containment shell was ignored in the design of the gamma shield. A conservative design was developed. Conversely, the mechanical strength of the gamma shield was ignored when the containment shell was developed, which is also a very conservative assumption. The total integration of an overall systems design will undoubtedly decrease the weight of each system.

The design of the containment subsystem, to date, is covered primarily in Reference 17. The salient features of that study are described here and the reader is referred to the source material for calculations which justify the listed choices [17].

The design of the containment, together with the reentry protection shield, is driven by the accident/abort potential of the delivery system; i.e., the nuclear waste must be protected, which is a severe requirement. Without attempting to list all possible accidents, one need only consider a failure on the launch pad [ $H_2/O_2$  explosion near the Solid Rocket Motors (SRM)] or a Shuttle failure which occurs near orbit to envision potential accident environments.

The containment shell was studied with respect to various abort times along the ascent trajectory such as Solid Rocket Booster (SRB) staging, External Tank (ET) separation, and near orbital conditions; and it was determined that the most severe (reentry) environment for the shell occurred if abort occurred just prior to orbit. A failure at this time resulted in an ultimate impact velocity of almost 250 m/s. The loads on the system during descent totaled approximately  $4.45 \times 10^6$  N. These loads were considerably lower than those experienced at water impact, however. The highest loading — an impact on granite — is discussed later. The loadings that dictated the design were sized by water impact considerations.

An immediate tradeoff that must be confronted is that the aerodynamics of the reentry capsule, to achieve minimal impact velocity, requires a large blunt nose. This is exactly converse to the design that would minimize water impact loads, i.e., a slender needle-like configuration. The dilemma was resolved by requiring a rather slim nose for water impact loads (0.91 m) and attaching a large flare behind the waste package to act as an aerobraking device. (The flare was used in additional roles in that it becomes a parachute stowage area and a flotation cell for ultimate recovery. The parachutes were assumed to have failed, however, when the loads were sized.)

For an 0.91 m diameter nose and an impact velocity of 250 m/s, the impact pressure on the dome was calculated to be approximately  $38 \times 10^6$  N/m<sup>2</sup>, and this occurs at approximately 0.05 ms after impact. By 4 ms after impact, the force has dropped close to zero in comparison with the initial force. (The loads on the flare are obviously much smaller.) The deceleration load on the capsule peaks at approximately 1 ms and attains a value of 450 g.



(The time scales involved and the magnitude of the calculated forces indicate that we are operating outside the range of most engineering data. Indeed, various theories describe differing results and an experimental program would be needed to obtain hard data.)

The results of the previous analysis must be translated into actual thickness of materials before they are to be used in sizing the waste container. A shell of constant thickness is very wasteful, and it was found that a "tapered" containment shell successfully met the requirements. The thickest portion of the shell (at the dome) was calculated to be 19 cm (using a safety factor of 1.5). The shell decreases in thickness until the flare occurs, and the flare thickness can be expected to be on the order of 0.34 to 1.28 cm.

The impact of the total capsule in water can be estimated as an engineering problem. In Reference 17, it is shown that this solution is compatible with the constraints of Shuttle lifting capacity, payload positioning requirements, etc.

Furthermore, the first nominal backup system for the unlikely event of a Shuttle failure is intact abort capability and a return to a landing strip. If the Shuttle failure is catastrophic, which is more unlikely, then the payload package is ejected. (A description of the ejection system is included in this section.) The system design involves the use of braking parachutes which will slow the package to approximately 30 m/s at impact. Nonetheless, the containment shell is sized for an impact velocity of 250 m/s in water; i.e., a total parachute failure is assumed.

Land impact is a possibility from any terrestrial launch site. If it is assumed that the compounding of improbabilities presents a catastrophic Shuttle failure followed by a totally inoperative parachute system, then the probability of land impact is still exceedingly small for the assumed launch sites. Indeed, the abort window, which results in land impact, is only a few tenths of a second.

Impact on soil which has the characteristics of soft sand is not much more severe an environment than is impact on water (water impact at 250 m/s is approximately equivalent to such an impact at 140 m/s). Our assumed safety factor would then very probably retain containment.

The ultimate test involves impact onto a granite massif, and this scenario would probably result in cracking (though not fragmenting) the containment shell. An immediate backup system (the gamma shield) has not been included in the potential ultimate rupture calculations. This is an area of the study for which no answer exists at the present time. It will be investigated as the study progresses.

Perhaps the more serious threat which occurs from land impact is not breaching of the package, per se, but rather an eventual meltdown of the package. The cooling effect of sea water will guarantee a cool package if recovery occurs in water, but the



temperature will certainly rise if land impact occurs. Two circumstances mitigate the heat problem, however. One of these is that at the time of abort the package is rather cool and it has a very large thermal inertia. (Preliminary calculations indicated that even several days after injection into a transfer orbit the package had not attained an equilibrium temperature.) Furthermore, the surroundings and/or weather patterns (e.g., rain) could slow the time to reach equilibrium. Another inherent advantage of space disposal is that failure is detected in real time and a trained recovery team would probably be dispatched in an airborne scramble before the package even impacts the Earth. The recovery aids (pingers) would make location a simple matter.

The package would be an object of curiosity to most humans and possibly even animals, but its temperature would preclude close approach. If it was deemed necessary, various repelling attachments could also decorate the package.

#### **D. Thermal Protection System**

As in the case of the mechanical containment system, the thermal protection system was designed by NSI. The total results of their study are given in Reference 17 and only a brief summary is given here.

The reentry heating thermal protection system and internal heating of the waste are treated together. This discussion is rather unique in that few reentry problems have to worry about both external and internal heating. The calculations indicate that if the conditions at initiation of a catastrophic abort correspond to equilibrium conditions in the Shuttle then the nuclear waste temperature will not rise significantly during reentry. That is, the problem eventually decouples.

Several candidate materials for reentry protection are investigated: ATJ graphite backed with Min-K insulation, noncharring carbon phenolic, charring silicone elastomer, and noncharring phenolic nylon. The optimal system, to date, is baselined as ATJ graphite-Min-K insulation over the hemispherical waste package with carbon-phenolic used in the flare and base regions.

ATJ graphite is a brittle material, which is one reason it was chosen. The purpose in wanting a brittle material is that if the package impacts the ocean (as is desired), the water is expected to cool the nuclear waste until such time as rescue arrives. Reentry materials, by their very nature, do not allow a transferral of heat to any significant degree and, thus, the necessary heat protection shield becomes a detriment once impact occurs. One way out of the dilemma is to guarantee that the shield fragments upon impact. This raises the possibility that mechanical flexure during reentry, vibration loadings, etc., could strip away the shield before impact.

ATJ graphite represents an attempt to produce a safe reentry thermal protection system which breaks away on impact. It may not represent a practical solution, however. The difference in loading between reentry and impact is so great that an acceptable material must exist. Future work will include further investigation of this point.



An aspect of the thermal design which has yet to be addressed is the on-pad explosion. The most severe environment in this case has yet to be determined, but the following is offered as a potential limiting case. Suppose that a Shuttle explosion occurs in such a way that the two solid rocket motors land on each side of the waste package and burn for the maximum possible length of time. This is obviously an extremely unlikely event either geometrically or physically (i.e., nonpropulsive burning of the SRM). The possibility of such an event occurring must be investigated and, if found to be possible, the thermal protection system must withstand such an assault. No comparison between the required thermal protection system for this case and the reentry case has been made to date.

### **E. Ejection System**

The ejection system for the nuclear waste payload will be used only in case of a catastrophic Shuttle failure. In the event of this type failure, the payload bay doors will be blown off and the payload and associated supporting structure will be ejected. It was assumed that the weight to be ejected will be 29 000 kg.

The ejection system consists of six TE-M-424 SRM's. These motors are existing equipment that were developed as S-1C retro rockets. The hazard class of both motors and igniters are ICC class B and military class 2. The six motors have a total weight of 1373 kg and develop a thrust of  $2.292 \times 10^6$  N for 0.63 s.

The ejection system accelerates the payload at  $79 \text{ m/s}^2$  which is sufficient to clear the rear of the payload bay and the Shuttle vertical tail. Ambient pressure of  $1.013 \times 10^5 \text{ N/m}^2$  (1 atm) was assumed for calculation of system performance data. Figure 22 depicts the proximity of the payload and the rear wall of the payload bay during ejection for constant Shuttle linear accelerations of  $29.4 \text{ m/s}^2$  (3 g) and  $44.1 \text{ m/s}^2$  (4.5 g). The relative position of the Shuttle to the payload (both Shuttle and payload under no acceleration) for 6 s after payload bay clearance is shown in Figure 23.



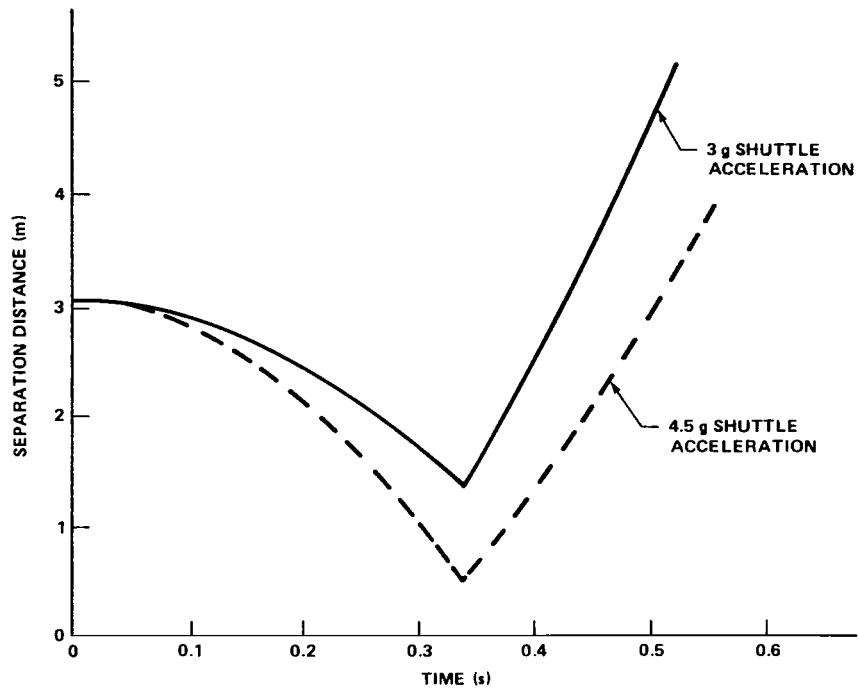

Figure 22. Orbiter/payload separation.

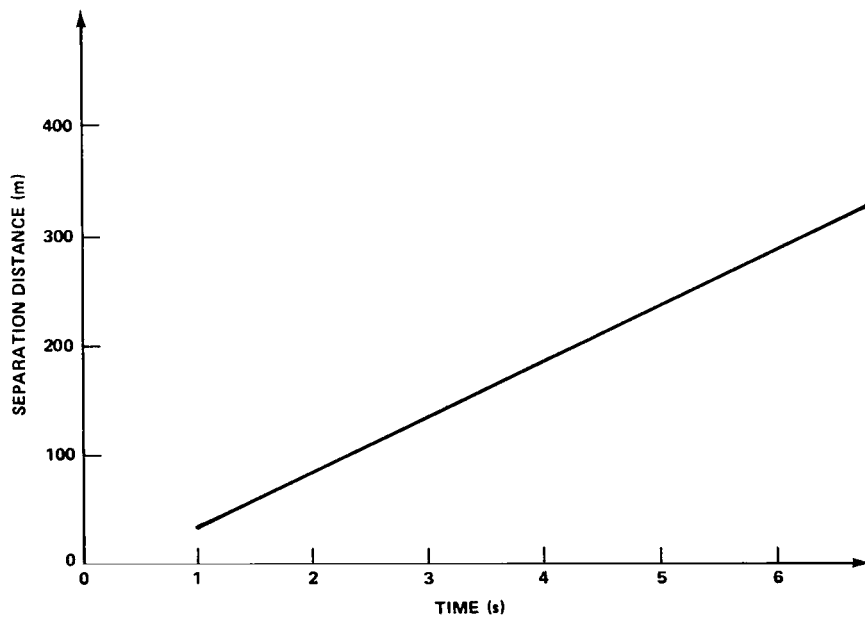

Figure 23. Orbiter/payload separation.



## V. MISSION SCENARIO

The mission scenario discussed in this section will deal with events from launch to disposal. The section of the waste package history preceding delivery to the launch pad is not covered here.

The space disposal of nuclear waste involves the launch of two Shuttles, and the scenario does not depend upon whether Mix 2 or Mix 3 is carried. The scenario is, however, destination dependent; therefore, two scenarios will be described for those areas where differences occur.

The launch of Shuttle No. 1 is (in all ways) a standard space launch for any Shuttle vehicle which carries an OTV. The loading, countdown, launch, and ascent would be expected to proceed in the same manner as would a purely scientific mission. The only modification that might be expected is that launch times would be chosen to match the window for the chosen destination; however, this type of constraint occurs in virtually all launches. The orbital destination for Shuttle No. 1 would be a rendezvous compatible orbit with respect to the launch of the subsequent Shuttle.

Once on orbit Shuttle No. 1 unloads the OTV and performs a complete systems checkout of that vehicle. If, at this time, any malfunctions on the OTV are identified the first corrective action would be to repair the malfunction on orbit if possible. Barring the possibility of such a repair, the OTV would probably be nonpropulsively vented and returned to Earth base for renovation.

If the systems checkout reveals a nominal situation on orbit, the preparation for launching Shuttle No. 2 will proceed. Fueling of the second vehicle would occur and checkout completed while the nuclear waste payload remains in site storage. Once the preparation of the vehicle is complete, the payload is removed from on-site storage and coolant lines are switched from ground-based to a coolant cart supply. The coolant cart then moves the payload to the launch pad where the payload is transferred to the payload changeout room and then to the Shuttle. There is a brief interruption of coolant flow during this period, but the thermal inertia of the package allows more than adequate time for changeover.

Once aboard Shuttle No. 2, the package is again connected with an active cooling system on the vehicle. Final checkouts involve only the package/Shuttle interface, and if any difficulties are encountered they can either be repaired or the mission cancelled as fits the case.

Shuttle No. 2, at the launch window, ascends to a near rendezvous with the first Shuttle and the demated OTV. The second Shuttle assumed a station near the pair of orbiting vehicles. The cargo bay doors are opened and the waste package is removed from the manned craft via remote manipulator arms. At the time of removal, the active coolant loop is again broken.



The package is retained by the manipulator arms until final checkout and then is released. The package is stabilized via an integral RCS.

Shuttle No. 2 now withdraws to a convenient distance and the waiting OTV approaches the stabilized package. The OTV docks and the cocoon remains stationary while the transfer vehicle backs away from it. At this time, much of the protective cover is removed from the waste package. The reentry thermal protection system, mechanical containment, and gamma ray shield (the "cocoon") are removed as a unit from the waste package. In the case of an unsuccessful dock that cannot be repaired, the waste package would simply be resealed and returned to Shuttle No. 2 for coolant reconnection. The subsequent history then becomes a function of the gravity of the problem and which piece of equipment is causing trouble. In the worst case, the package could be returned to Earth for repair and relaunch.

The mated OTV waste package can now be assumed to be prepared for final departure. Thus far, the scenario has been independent of destination but further description requires a branching of the options.

The case of a transfer to the lunar surface is presented first (Fig. 6). The initial OTV burn is relatively long and adds an increment of 2952.2 m/s. The vehicle coasts away from the Earth under monitoring and careful tracking in this intermediate orbit. At apogee, where the speed is a minimum, a second burn occurs, which serves two purposes: it rotates the orbital plane to match that of the Moon and, at the same time, raises perigee. The second burn adds a velocity increment of only 4 m/s.

By the time perigee is reached, careful tracking has established all orbital parameters. A perigee burn then establishes a lunar "impact commit." This burn is of the 244.4 m/s magnitude. The state-of-the-art of guidance and navigation is such that a lunar impact can be guaranteed at nominal thrust termination.

The fourth burn (2.9 m/s) is a targeting burn that specifies an exact landing point. In case the third burn is near perfect, this burn may be cancelled entirely.

The final burn (2850.1 m/s) is a retro braking burn near the lunar surface. It is calculated to deliver the package to the lunar surface at zero relative velocity.

In the case of disposal in solar orbit, the mission scenario differs from that just described. Due to the nature of the solar orbit mission and the smaller  $\Delta V$  requirement, the OTV can be utilized in a reusable mode, but an additional solid propellant stage is added to the system. The solid stage is launched to orbit together with the OTV.



One long burn (3260 m/s) of the OTV occurs, and the OTV separates from the waste package and solid stage for return to LEO. The waste package moves toward the Sun on an elliptical transfer, achieving a perisol of 0.86 AU 6 months later. At this time the small solid stage is ignited to produce a velocity increment of 1190 m/s, and a circular orbit is achieved.

In either of the two previously described scenarios, the cocoon remains in orbit on station with the two Shuttles. Following launch of the OTV, Shuttle No. 2 retrieves the cocoon and stows it in the cargo bay for return to Earth and subsequent reuse. For the lunar mission, Shuttle No. 1 would return empty or be used to pick up a payload that is unrelated to the waste disposal program.

In the case of a solar orbit destination, the first Shuttle would return with an empty OTV. This could be the OTV which was just used on the mission or could be an OTV from a prior mission.

The reason for retrieving the OTV in the case of a solar orbit mission and not retrieving in the case of a lunar mission is simply a question of economics. The lower required fuel expenditure for the solar mission allows for an economic OTV recovery, whereas the lunar mission does not.



## VI. GROUND OPERATIONS

### A. Transportation from Reprocessor to Receiving Facility at Launch Site

The options for transportation are dependent upon the location of the reprocessing facility and the launch site. A combination of transportation modes is conceivable; however, it might involve added interfaces in handling the container.

The options for transportation between the reprocessing facility and the launch site are (1) highway truck, (2) rail car, (3) barge or ship, or (4) a combination of these.

The characteristics of the high level waste (HLW) and the cooling requirements are such that the shipping cask and container weight probably will exceed the allowable highway weights by a factor of 1.5 to 2. It is possible, given access to a navigable waterway, that special trailers could be used to transport overweight casks onto a barge without traveling on public highways. In a similar manner, special rail cars could also be transported by barge for part of the trip.

The use of special rail cars appears to offer the greatest flexibility for (1) reprocessing facility location, (2) launch site location, (3) alternate routes, (4) all weather movements, and (5) anticipated weights.

Overseas transportation would involve shipment of the cask to the seaport by rail, truck, or barge; disconnection of the cooling system; hoisting into the ship hold; and reconnection of the cooling system. The same general procedure would be followed at the receiving port. Shipment to the seaport by barge could include additional transfers such as from the barge to the dock and from the dock to the ship.

1. Receipt of the Cask at Receiving Facility. The cask will be delivered to the receiving facility and offloaded by overhead crane from the transporter. The cask is opened and the cocoon-shield package (CSP) is inspected and removed. It may be necessary at this point to attach a temporary neutron shield to the CSP which will remain until loaded aboard the Shuttle. During this process, the cooling system is disconnected and the CSP is connected to the facility cooling unit. The cask and its cooling unit are returned to the reprocessor.

The receiving facility should be in a building which would minimize spread of contamination in the event of faulted conditions. However, it need not incorporate remote handling facilities. There should be equipment to cope with various package problems, leaks, cooling system failures, etc. The handling area should be designed to facilitate decontamination, should such activities be required. Systems should be available to complete the assembly of the cocoon by attaching the nose and tail assemblies and to perform all inspections and system tests.



## B. Launch Site Selection

The factors presented here must be considered in the selection of a launch site for nuclear waste disposal mission.

1. Ground Track of the Ascent to Orbit Trajectory. The ground track of the ascent-to-orbit trajectory is of primary importance. Ideally, one would like a ground track that was completely over water such that the nuclear waste package would land in the ocean for uncontrolled aborts. The impact loads would be less and, with the aid of flotation devices, recovery from the ocean would not present any insurmountable problems. Also, having an aborted payload dropped in the ocean would not create the international incident that would occur if the waste package landed on foreign soil. Figure 24 shows a ground track for a Kennedy Space Center (KSC) launch. To keep the ground track off of South Africa, yaw steering was utilized after SRB separation. The dwell time (the  $\Delta t$  during which a failure must occur to result in land impact) over the Greater Sunda Islands and the northwestern tip of New Guinea is less than 0.4 s. Thus, the probability of an uncontrolled abort occurring that would result in ground impact is very small.

As long as the nuclear waste disposal launch rates are low, it is expected that existing launch facilities at KSC could be used. As the launch rate increases, additional launch pads and associated facilities will be required. The construction of a remote launch site offers the advantage of removing the launch area away from highly populated areas so that risks of possible launch pad or near launch pad accidents to man would be minimized. The proper selection of the remote launch site would provide for minimum overflight of land during ascent to orbit.

Figure 25 shows a ground track for a launch from the island, Trindade, which was chosen as an example of a remote site. No major significance should be attached to this preliminary choice, it merely represents a possible launch site that presents a difficult problem in fitting together the necessary components. (Trindade is uncomfortably small.) A launch azimuth of  $121^\circ$  was assumed to minimize ground overflight. The dwell time over Indonesia and the Philippines is less than 0.5 s. Table 8 presents a comparison of launching from KSC versus Trindade.

Due to the variation in terrain on Trindade, it would be very expensive to construct a runway of sufficient length to land the Shuttle Orbiter. Figure 26 shows a layout of a remote operational base for Trindade. The Orbiter would be flown to an airfield on the South American continent and transported by ship to Trindade. For a nominal mission launched from Trindade, the Shuttle Orbiter would land at either KSC and be flown to the South American landing site via a 747 or land directly from orbit. For missions where the nuclear waste has to be returned from orbit due a subsystem failure, landing would be at a remote landing site. Figure 27 shows the deorbit opportunities for a Trindade launch. Figure 28 shows the same data for a KSC launch.



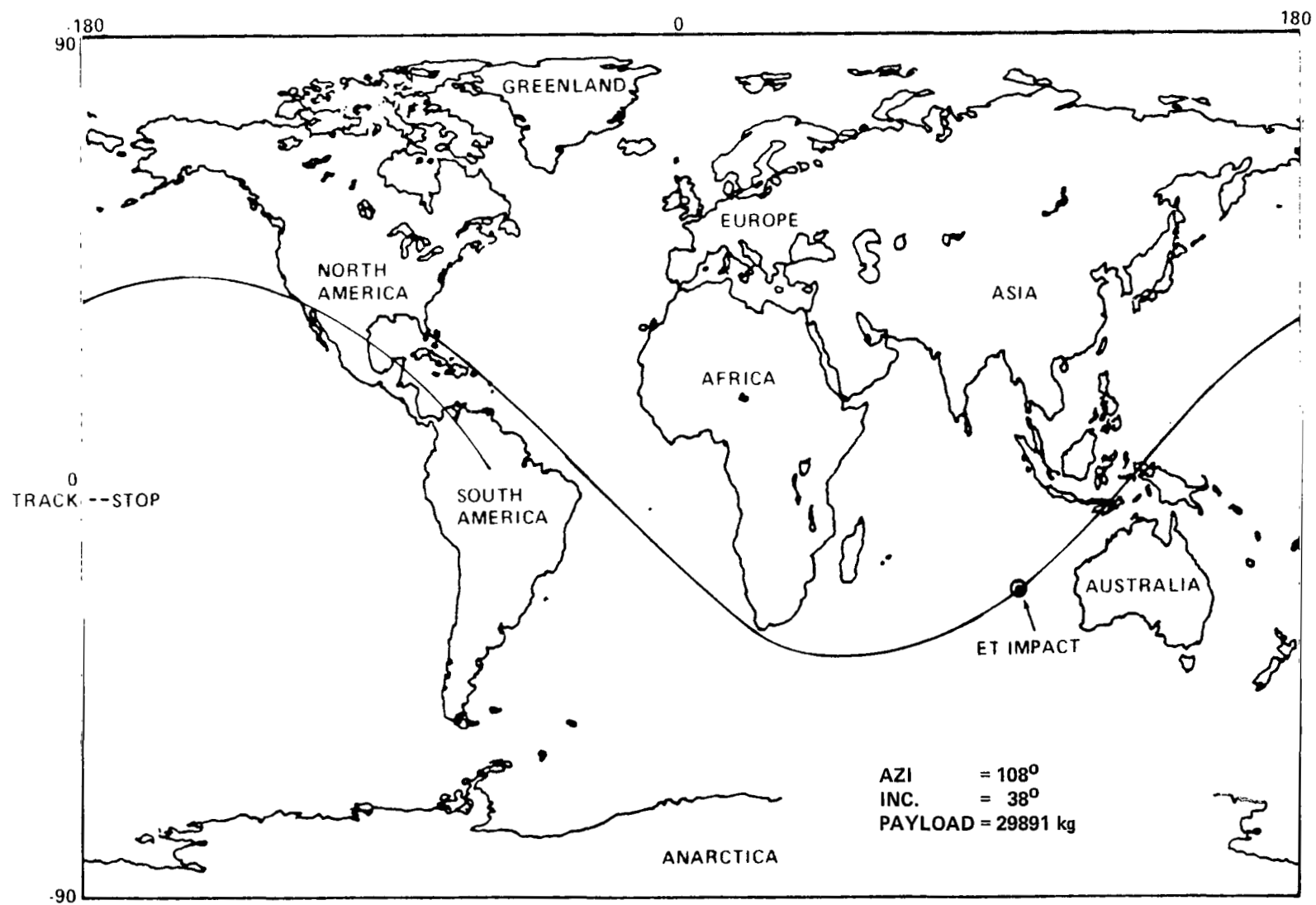

Figure 24. Orbiter/ET impact trace for ETR launch (yaw steering after SRB separation).



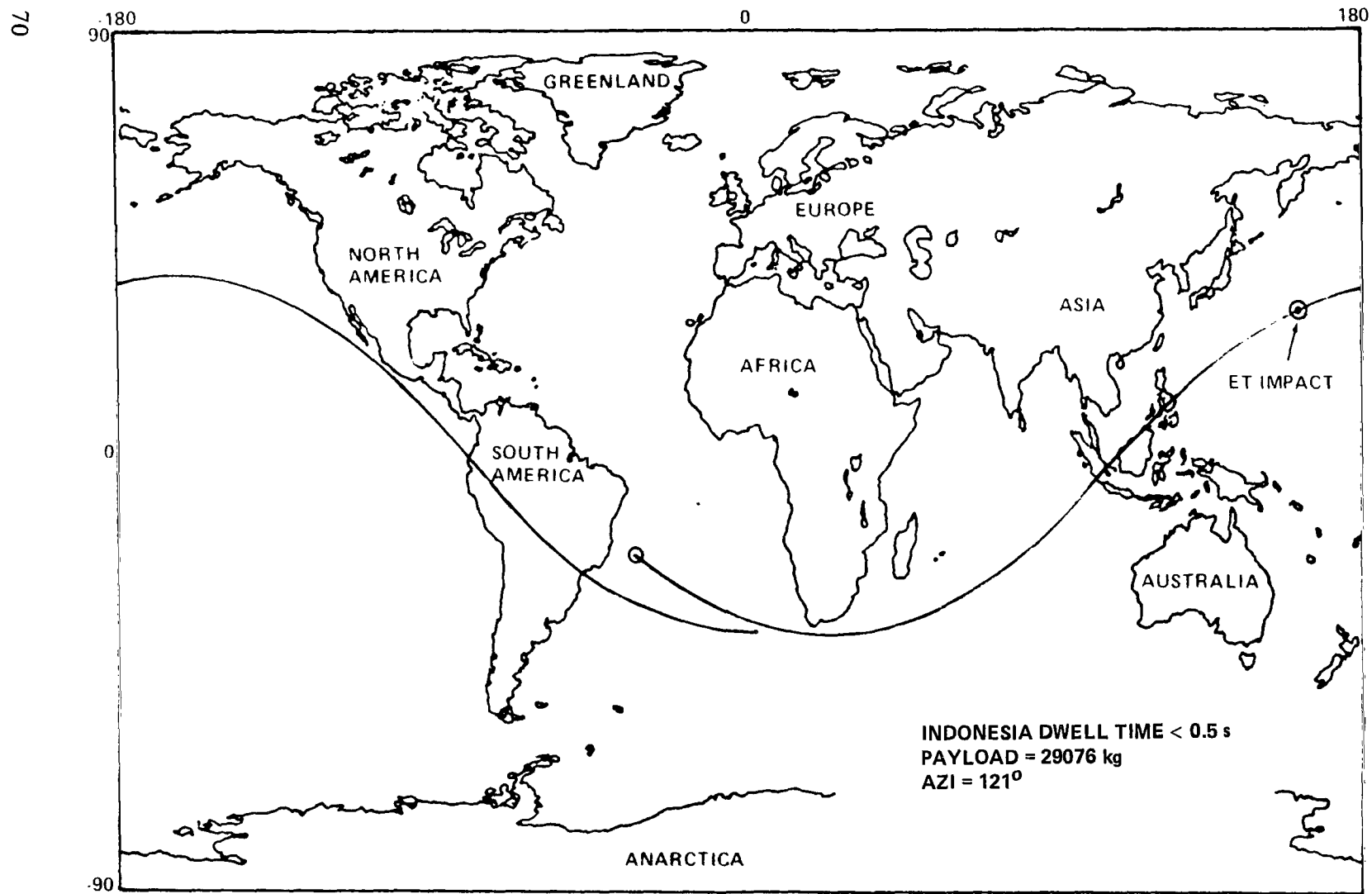

Figure 25. Orbiter/ET impact trace for Trindade launch.



2. Cost, Availability, and Accessibility of a Remote Launch Site. In preparing the cost estimates from a remote site, a factor of two is used to account for the increased costs. All labor and equipment would have to be transported to and from the site. To construct the site, harbors and docks would be required. In summary, the construction of a new remote launch site would be a very large cost undertaking.

The availability of the selected new launch site would have to be considered early in the program, and would depend on the diplomatic relations with the country concerned. With the vast amount of money involved, national commitments for a long period of time would be required. The other country involved would stand to gain in many economic ways from the construction and operation of the new launch site.

The new launch sites under consideration, which would give the minimum overland flight time, are either natural islands or possibly a manmade base. Accessibility to either of these will be difficult. All equipment and supplies will require transfer by boat which will make the entire operation sensitive to weather. Operational problems and launch delays would be frequent and unavoidable.

TABLE 8. ETR AND TRINDADE LAUNCH SITE CONSIDERATIONS

	ETR	Trindade
Can share some existing launch facilities	Advantage	Disadvantage
Potential nuclear contamination of general launch facilities	Disadvantage	
Dedicated, secure launch facilities	Disadvantage	Advantage
No land impact for a controllable orbiter	Advantage	Advantage
Extremely small dwell time over land	Advantage	Advantage
ET impact in an approved area	Advantage	?
International launch site	Disadvantage	Advantage
U.S. waste must be shipped by boat		Disadvantage



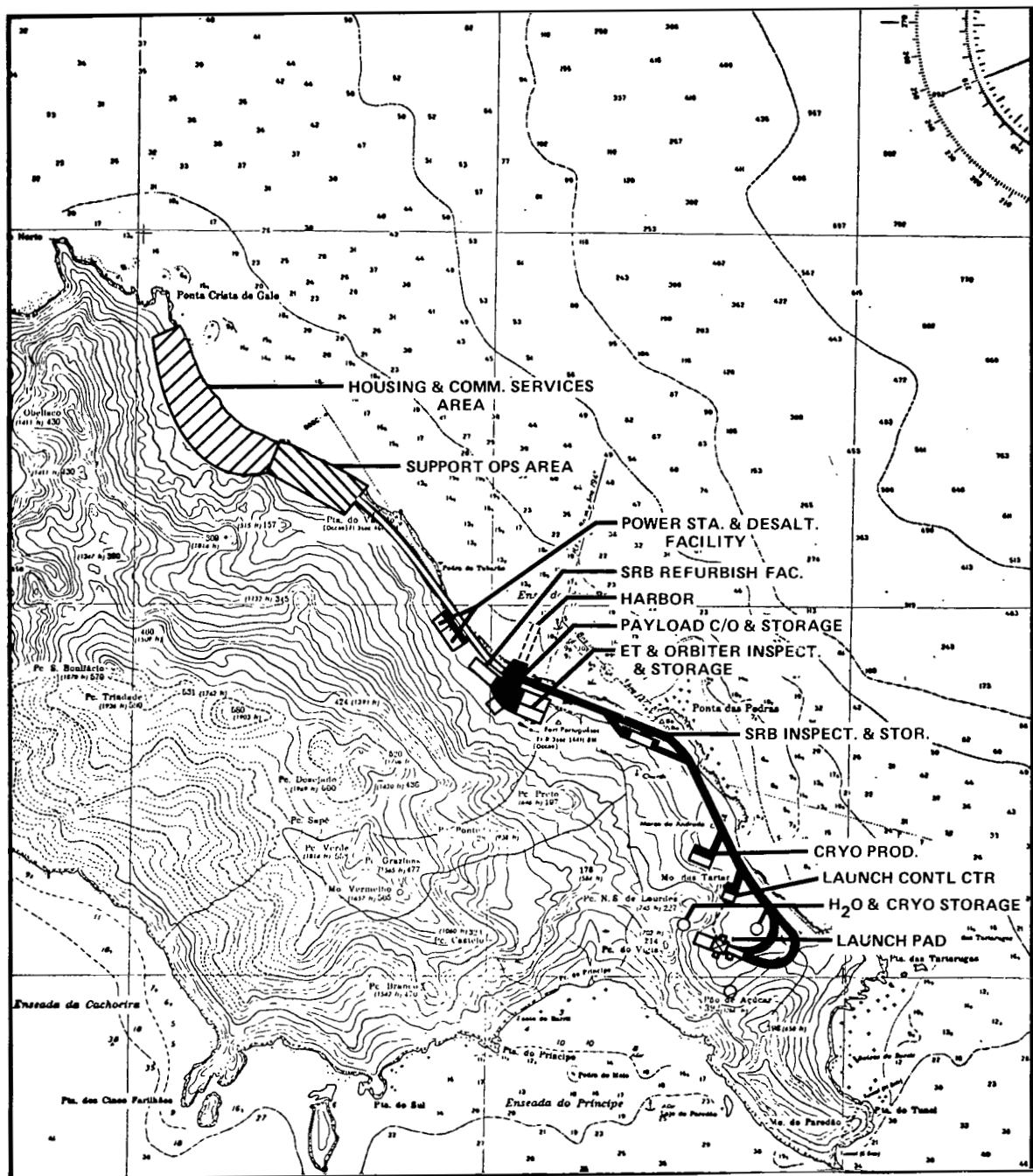

Figure 26. Remote operational base concept Trindade Island (Brazil).



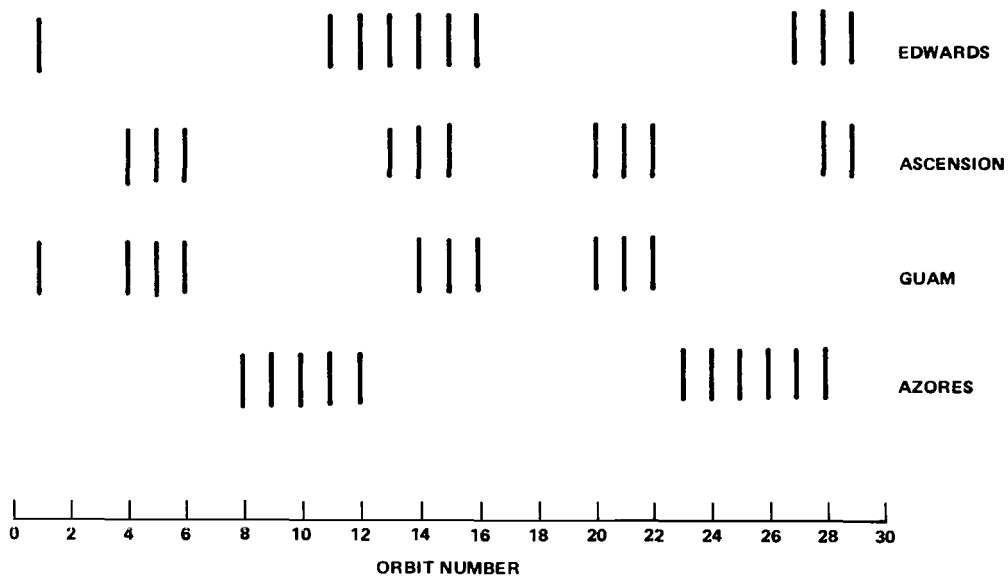

Figure 27. Deorbit opportunities for Trindade launch.

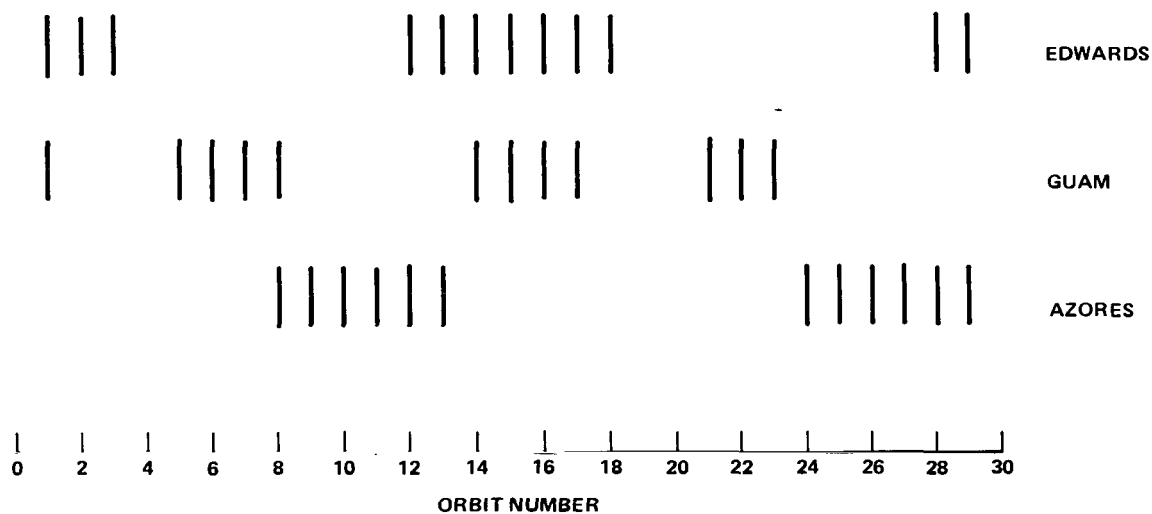

Figure 28. Deorbit opportunities for KSC launch.



3. Acceptance by the Local Population of the Nuclear Accident Risk. This area can be considered from two aspects. The first is if the nuclear payloads are launched from KSC and the second is from a remote launch site. The general attitude of the U.S. population has not been positive in this type of activity. For instance, the establishment of terrestrial storage facilities has encountered negative response from the local populations. The increased economic benefits from a high launch rate would mitigate the risk of an accident and could help in local populace acceptance.

If the remote site were a manmade island or base, no local population would be involved and therefore it would not be a problem. If the site were an inhabited island, similar problems to KSC would be involved. Possible solutions would include economic considerations either as employment at the site or total displacement for economic consideration or both.

4. Potential Hazard to the Local Population and Surrounding Area in the Event of a Launch Facility or Launch Vehicle Accident. Although the nuclear waste packaging will be designed to withstand the worst credible accident scenario, ground rules will require an assumption of spillage even though it is not likely to happen. The results of such an accident might cascade throughout the environment in both the short and long term and will be considered further in future reports. For further information on possible causes and results of such an accident, see Reference 8.

5. Nuclear Waste Mix Selected for Launch. This factor needs to be considered in the launch site selection because it directly influences the launch rate. High launch rates at a remote site would greatly increase the logistics problems. However, the high launch rates would make the remote site more attractive because of the sonic booms from the returning Orbiter.

### **C. Required Equipment and Facilities**

The equipment and facilities required for launching the nuclear payload will depend on whether the payloads are launched from KSC or if a new site is developed.

If the launches are from KSC, some parts of the existing STS could be used with some new equipment added. As the program grows, additional dedicated facilities would be required.

The initial ground facilities would include a nuclear facility for processing and checkout of the payload. To provide complete assurance of mission success, a total payload including cocoon and OTV systems mating and operations test should be performed. The facility would provide all necessary ground support equipment (GSE) for receiving, unloading, storage, and checkout of the payload. In addition, it would provide a place for storage and reprocessing in case of a payload accident.



To transport the payload to the launch pad, a new dedicated transporter would be required. This transporter would include cooling GSE and would be compatible with the PCR. Other GSE would include handling, cooling, and servicing equipment for the payload and OTV.

The OTV could be processed at KSC initially in existing facilities; however, as the launch rate increased, it would be necessary to add dedicated facilities.

The building of a new launch facility for a Shuttle type orbiter on a remote island would be a large and expensive undertaking. An estimate of the cost is approximately two billion dollars. The cost is also dependent on the weather at the remote site. If bad weather can be expected, the launch vehicle would have to be assembled inside, as at KSC, and a mobile launch platform used for transfer to the pad.

A brief listing of remote facilities and equipment is as follows:

- (1) Nuclear facility
- (2) Launch pad and crawlers
- (3) Vertical assembly building
- (4) Orbiter landing strip
- (5) SRB facility
- (6) Manufacture facilities, storage, and transfer of propellant, fluids, and gases.
- (7) Orbiter processing facility
- (8) Launch control center
- (9) Personnel facilities
- (10) Harbors, docks, cranes, and transporters.

#### **D. Comparison of Ground Operations for Space Disposal Versus Terrestrial Storage**

For terrestrial storage a very simplified flow would include the following steps:

- (1) Load selected waste into a container which is compatible with the handling system
- (2) Seal container



- (3) Perform heat load and hot spot tests
- (4) Load into shipping cask, attach cooling equipment, and transport to storage site
- (5) Receive, disconnect cooling equipment, and inspect at storage site
- (6) Transport to storage entrance
- (7) Mate with remote handling equipment
- (8) Transfer to selected site in storage facility
- (9) Return transfer equipment to storage entrance.

A number of assumptions are made for this flow; e.g., the site is within the U.S., and that no cooling is required at final storage site.

For space disposal of nuclear wastes it is necessary to define operational flows for three elements. These elements are the nuclear payload, the cocoon, and the OTV. Flows for the payload and the cocoon are shown on Figures 29 and 30. The flow for the OTV is standard and is not presented.

The flows would include the following steps:

A. Nuclear Payload

1. Load selected waste into a container which is compatible with the flight system.
2. Seal container.
3. Perform heat load and hot spot tests.
4. Load into shipping cask, attach cooling equipment, and transport to launch site.
5. Receive and inspect.
6. Mate to cocoon, perform checkout.
7. Transport to PCR.
8. Load into Shuttle and launch.



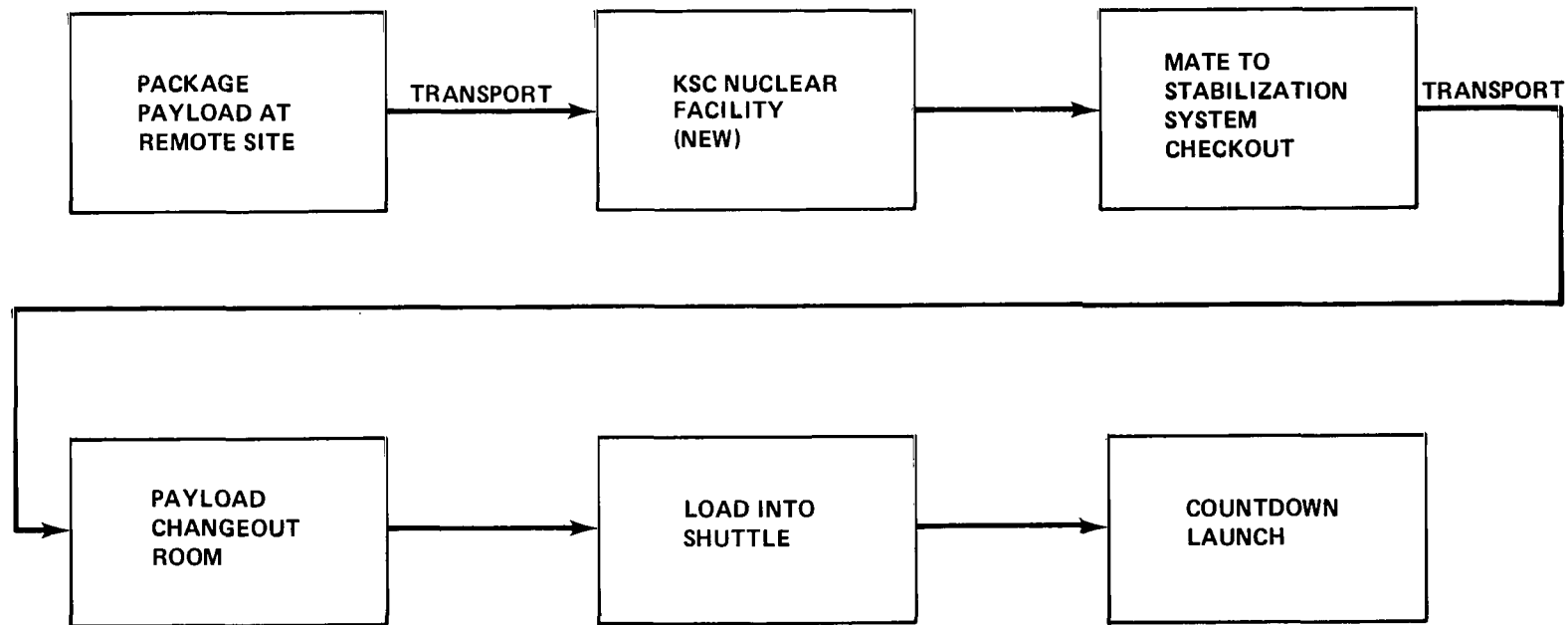

Figure 29. Nuclear payload flow.



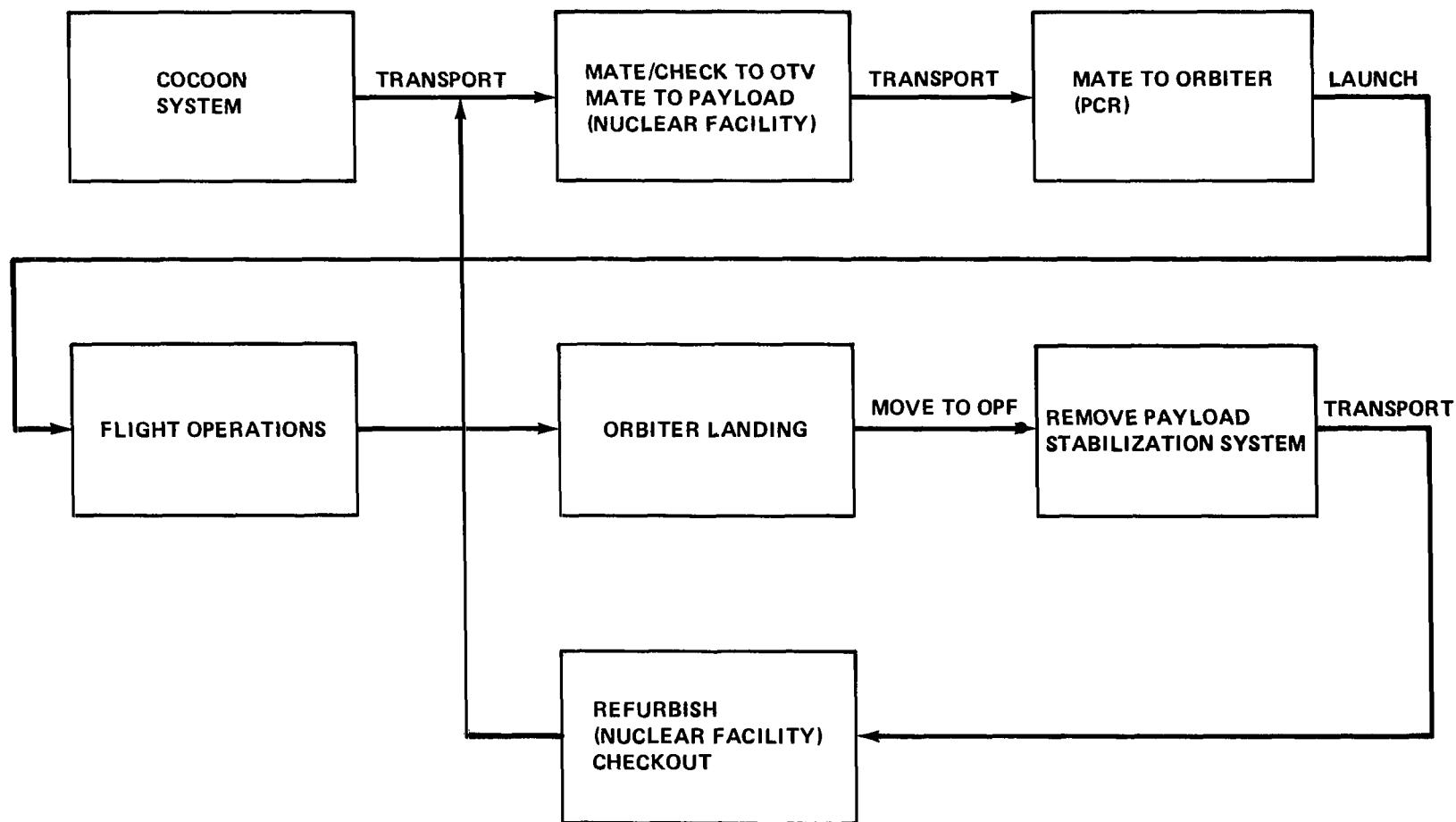

Figure 30. Cocoon flow.



## B. Cocoon Flow

1. Receive cocoon at launch site.
2. Mate/check to OTV and mate to payload.
3. Mate to Orbiter.
4. Launch/Flight Operations/Landing.
5. Remove cocoon from Orbiter.
6. Refurbish and recycle.

## C. OTV Flow

1. Manufacturing and checkout.
2. Receive at launch site and checkout.
3. Mate to Orbiter.
4. Assemble Shuttle.
5. Move to pad.
6. Launch and Flight Operations.

To summarize, the ground operations for space disposal and terrestrial storage are dissimilar. For the current baseline space disposal, the nuclear waste will utilize Mix 2 or Mix 3 to reduce the amount to be flown. This will result in a reduced number of ground transport trips for space as compared to terrestrial disposal. The flight vehicles will need active cooling and, later in the flight, passive cooling. The need for active cooling will influence all of the ground operations. The flight payload will require a completely different design for handling, lifting, and transportation. And finally, weight will be a prime consideration in the flight option.



## VII. SAFETY AND RELIABILITY REQUIREMENTS

Space disposal of nuclear waste can be achieved for any of the space options discussed in Section III. All of the options considered are, from a technical standpoint, less complicated than the highly successful Apollo and Viking missions. The main issue is one of overall mission safety. At most, a mission failure in either the Apollo or Viking programs resulted in the loss of several hundred million dollars, and in the Apollo program, a three man crew. However, in the space disposal of nuclear waste, a mission failure could endanger the lives of thousands of people. Thus, overall mission safety is a prime program driver.

The probability of mission success is an important figure of merit for missions such as Viking and Apollo because it represents the probability of achieving the planned scientific goals. In the space disposal of nuclear waste, one would like the probability of mission success to be as high as possible; however, a more important figure of merit is the probability of not contaminating the environment (releasing radioactive waste) in disposing of nuclear waste in space. It is important to note that the probability of not contaminating the environment is not 1 minus (the probability of mission success). There are many subsystem failures that could preclude mission success, but would not result in the release of nuclear waste. This is especially true for a manned, winged vehicle like the Space Shuttle. Also for a catastrophic Shuttle abort, the reentry protection system will allow safe return of the waste package to the Earth. For OTV failures that leave the waste package in an unacceptable orbit, rescue can be achieved with a backup vehicle.

A Failure and Contingency Analysis (FACA) was performed to postulate the most probable failures and to develop contingency workarounds. These workarounds or alternatives are developed to allow completion of the mission safely, with minimum hazard to crew personnel and the Earth or lunar environment. To accomplish this, a mission event sequence was developed for each of the proposed missions. This sequence of events considers the various facilities and systems/subsystems involved in the various mission phases, and represents the flow of each toward mission accomplishment. An overview of the mission event sequence for a HEO mission is shown in Figure 31. Associated with these events are detailed task steps indicated in the lettered and numbered boxes of the mission sequence of events. These task steps have been developed for each mission option under consideration, and an example is shown in Figure 32. A complete list of the task steps can be found in Reference 17. The task flows were used as a basis for postulating a number of failures and alternative contingencies to identify recovery and safety requirements and to highlight safety concerns for each mission phase.

The basic assumption in an FACA study is that if a complex system can fail, it will fail, given sufficient time or opportunity. These failures can occur at random during a mission; thus, the analysis essentially compresses the spectrum of mission time and assumes that the failures do occur. For each failure or mission sequence interruption, one or more contingency actions or alternatives are suggested.





81



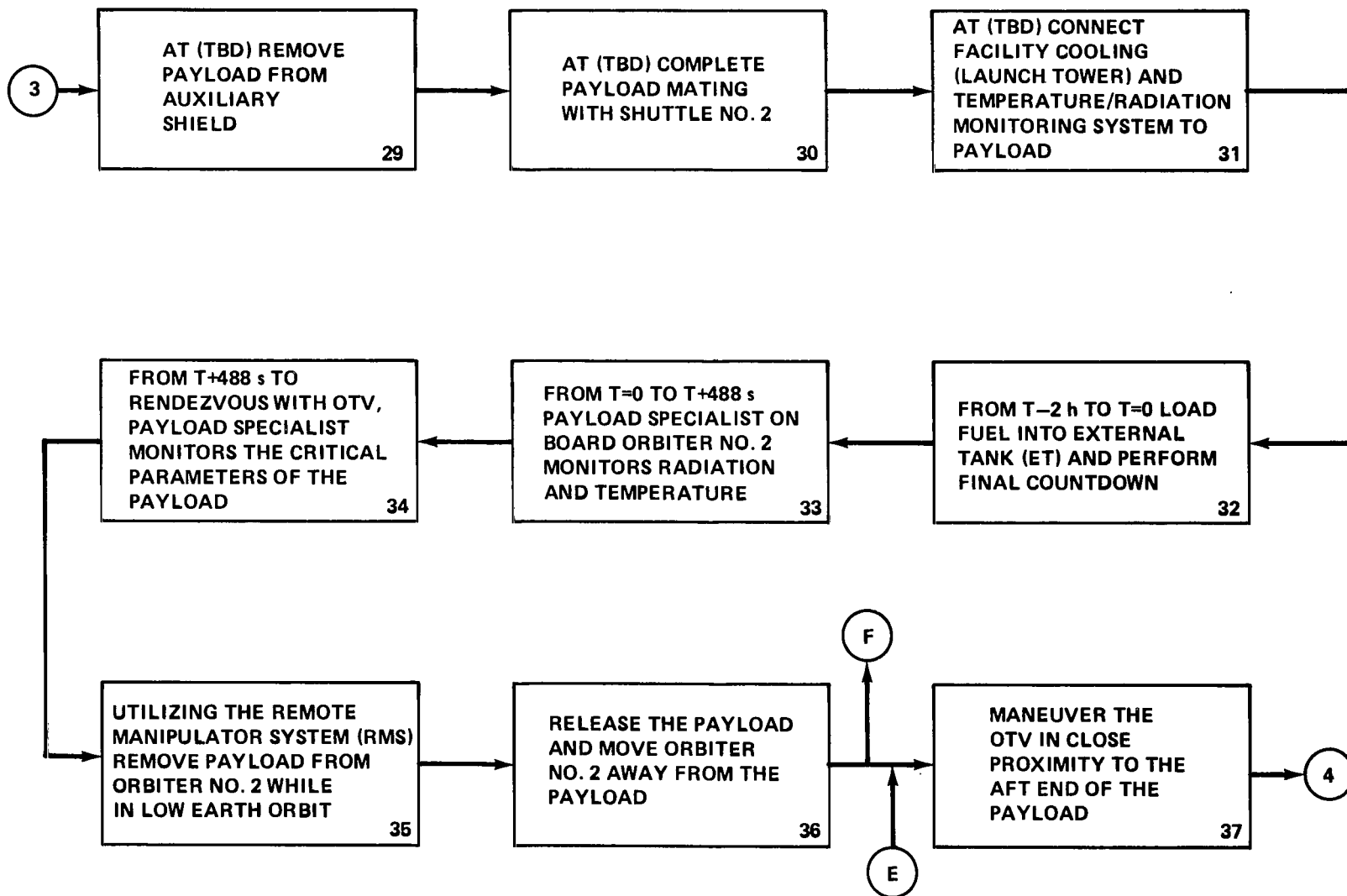

Figure 32. Detailed task steps of mission event sequence.



The outcome of the FACA exercise is a set of general guidelines and assumptions which have been developed for all phases of the mission and are presented in the next three subsections.

### **A. Ground Handling Safety Guidelines**

A number of potential accident situations exist during the various stages of handling from the initial stage of loading at the reprocessing facility through the loading into the Shuttle at the launch site. The period of highest risk (to the public and environment) appears to be during transportation and during the loading aboard the Shuttle. During the other handling periods, the waste is within facilities that should limit the spread of waste in the event of most conceivable accidents.

In the normal handling and transportation of a radioactive materials package, a variety of potential accidents are considered. Nuclear Regulatory Commission/Department of Transportation (NRC/DOT) regulations generally define the level of protection required to meet these accident situations. Ground handling of nuclear waste for a space disposal mission does not present any unique problems when compared to ground handling for terrestrial disposal; however, the packaging configuration for space disposal involves new concepts. A list of ten potential accidents is presented in Table 9. (This is certainly not meant to be a complete list.) Each of these types of accidents is rated on the basis of the consequences of it occurring at each location. In many instances the particular accident situation does not exist and is noted as not applicable (NA). In other instances the requirements of the NRC/DOT regulations are such that the consequences would be negligible. The following is a set of Safety Guidelines for the ground handling phase of the space disposal mission (other guidelines will be stated as the study evolves):

- (1) The nuclear waste will remain within its radiation shield during all NASA ground and launch operations.
- (2) Provide a nuclear handling facility at the NASA launch site.
- (3) Provide dosimeters badges for nuclear handling ground crews.
- (4) Provide training and procedures in the use of radiation monitoring equipment.
- (5) Provide fire alarm and protection system training and procedures capable of supporting the payload at the nuclear handling facility, the transporter, and the launch pad.
- (6) Rotate nuclear handling assignments for the ground crew to minimize the radiation dose for each person. Current standards limit the annual dose that personnel can receive.



TABLE 9. POTENTIAL ACCIDENTS INVOLVING TERRESTRIAL HANDLING OF  
NUCLEAR WASTE FOR SPACE DISPOSAL

Type of Accident	Consequences of Accident at			
	Processing Facility	Transportation	Receiving Facility	Launch Site
Spill canister	In hot cell bothersome, but can be isolated	NA	NA	NA
Burn through weld while putting cover on	Repairable	NA	NA	NA
Drop canister	In hot cell can be isolated	NA	NA	NA
Puncture canister (no other containment)	In hot cell can be isolated	NA	NA	NA
Drop canister and shield	Can be outside of hot cell. May crack and spill	NA	NA	NA
Drop canister, shield and cocoon	Meets NRC/DOT regulations. No problem	Meets NRC/DOT regulations. No problem	Meets NRC/DOT regulations. No problem	Probably scratch Mission
Loss of coolant	4 h to hook up new system	4 h to hook up new system	4 h to hook up new system	Could scratch mission or go on hold
Fire	In hot cell? Outside H.C.-cask meets NRC/DOT regulations, should survive	Outside H.C.-cask meets NRC/DOT regulations, should survive	Outside H.C.-cask meets NRC/DOT regulations, should survive	Catastrophic to Shuttle and launch
Submersion	NA	Meets NRC/DOT regulations. No problem	NA	NA
Puncture shipping cask	NA	Should meet NRC requirements	Should meet NRC requirements	NA

Note: Accidents and consequences involving the actual launch and space operation are discussed in Section IV.



(7) Train and have on 24 h a day standby an emergency crew for safing of the nuclear waste package.

(8) Assure that backup power is available for nuclear payload safing in the event of commercial power failure.

(9) Provide procedures and facilities for decontamination in the event of radioactive containment rupture or meltdown.

(10) Provide triple redundancy for the payload temperature monitoring circuits with a “kill” switch for each circuit, thereby averting a full safing alert in the event of failure of any one circuit element.

(11) Provide for an alternate storage cooling operation, i.e., the nuclear waste inside its radiation shielding to remain in the facility cooling pond prior to launch day and mating with the cocoon.

(12) Provide a “dummy” payload to be used to check out the physical fit and function of the payload with the Shuttle prior to launch day and as a training vehicle for OTV to payload attaching and release exercised.

(13) Maintain administratively controlled areas with a minimum radius of approximately 13 km and exclusion areas of 4 km radius from launch site.

(14) Install the payload at the last practical point in the Shuttle launch countdown sequence.

(15) Provide capability to defuel the Shuttle in nuclear emergencies on the launch pad.

(16) Provide for a cooling pond, pool, or large body of water adjacent to the launch pad.

(17) Provide and maintain a comprehensive training program for all personnel involved with the payload from receipt of the launch site through arrival at destination including emergencies and workarounds.

## **B. Flight Operations Safety Guideline**

In the area of flight operations, there are procedures and precautions that are utilized routinely on all space missions to increase the overall mission safety. In addition to these, additional procedures and precautions have been identified which should be implemented for nuclear waste disposal missions:



(1) Prohibit launch during unsatisfactory weather conditions, particularly with winds blowing toward populated areas.

(2) Minimize overflight of land and continental shelf areas.

(3) Consider Shuttle touchdown area remote from inhabited facilities.

(4) Provide dosimeter badges for Shuttle astronauts.

(5) Provide means of warning of imminent collision with orbiting vehicles.

(6) Provide training and procedures in the use of radiation monitoring equipment.

(7) Rotate nuclear handling assignments for the astronauts to minimize the radiation dose for each person.

(8) In case of abort, consider dumping of excess Shuttle propellant prior to landing to minimize explosive potential.

(9) Consider use of a back-up Shuttle to support repair of a failed Shuttle or transfer or retrieval of the payload in orbit for the continuance of the mission.

(10) Develop a credible heat/time chart after loss of coolant (TBD). Provide this to the payload specialist and mission control so that a judgment can be made to continue or abort the mission depending upon the time of failure within the overall mission time.

(11) Train the astronauts in RMS malfunction analysis and repair.

(12) Train the astronauts in payload stabilization while operating in the extravehicular activity (EVA) mode and utilizing his personnel attitude propulsion system (APS).

(13) Train the astronauts in malfunction analysis and disassembly of the payload access door mechanism into the nuclear waste package.

(14) Train the astronauts in the proper approach and retreat of the "hot" nuclear waste material utilizing shadow shielding provided by the cocoon and shield.

(15) Bias the trajectory (where applicable) so that the probability of Earth impact will be lessened in the event of failure of the OTV to make the final burn(s).

Again, this listing will be extended and/or modified as experience dictates.



### **C. Special Procedures/Requirements**

Certain Shuttle modifications and additions will be required to make the Shuttle more compatible with the nuclear waste disposal mission:

(1) Provide redundant circuits to monitor radiation and heat from the nuclear waste package.

(2) Assure that each redundant circuit is capable of checkout during prelaunch.

(3) Provide a remotely controlled, manually activated means of ejecting the payload during a catastrophic event at the launch pad.

(4) Provide backup automatic ejection of the payload in the event of a catastrophic event which might render a manual ejection system inoperative.

(5) Provide for detection by the flight crew of any redundant element that fails after mating of the payload to the Shuttle, and during the boost and LEO insertion phases.

(6) Consider a completely redundant onboard cooling system that can be switched over to the payload in the event of failure of the first system.

(7) Design for a positive and forceful means of ejecting the payload from the Orbiter (even to the extent of blasting through the Orbiter bay doors in the event that they could not be opened normally or rapidly).

Design of the nuclear waste canister and the reentry protection system was dictated by safety requirements. Special payload packaging design requirements are as follows:

(1) Design the cocoon so that the insulation and ablation material can be blown off in an emergency condition requiring immediate cooling.

(2) Package the payload in the Orbiter such that it will withstand a low altitude Orbiter-to-land crash or an Orbiter-to-water crash.

(3) Design the payload so that parachutes or aerodynamic braking will limit the water impact to such a level that the nuclear waste package will remain intact.

(4) Design the payload so that it will float in sea water.

(5) Provide search and recovery aids such as radio transponders, sonar pingers, dye markers, etc., which will aid in rapid recovery of the payload.



(6) Design for adequate cooling of the radioactive waste during seek and recovery operations.

(7) Incorporate a stabilization system in the payload package to prevent tumbling during LEO maneuvers.

(8) Design the payload so that the OTV is attachable to either the radioactive waste package or the entire payload.

(9) Design the nuclear waste package so that an OTV can attach to either end.

(10) Design the shield/cocoon with sufficient strength to contain the nuclear waste in the event of a Shuttle explosion at the launch pad.



## VIII. SPACE TRANSPORTATION SYSTEM REQUIREMENTS

Space disposal of the nuclear waste will place added requirements on the planned STS. Additional safety requirements will have to be satisfied due to the hazardous nature of the payload. More launches will be required, thus additional launch facilities will be needed in the late 1990's. Also, a high performance upper stage will be required to support the space disposal of nuclear waste.

The transportation of nuclear waste into space involves two phases: (1) boost into a LEO and (2) transfer from LEO to the final destination. The Space Shuttle and the STS derived Heavy Lift Launch Vehicle (HLLV) were chosen for the boost phase of the mission. A high performance cryogenic propellant OTV was selected for waste transportation from LEO to the final destination. Boost vehicle and OTV characteristics are summarized in Tables 10 and 11.

TABLE 10. BOOST VEHICLE CONCEPTS

Space Shuttle	Payload to LEO (160 n.mi.) – 29 483 kg
STS-Derived HLLV	
Class I (2 SRB)	Payload to LEO (270 n.mi.) – 59 200 kg
Class II (4 SRB)	Payload to LEO (270 n.mi.) – 101 000 kg
LOX-RPI Ballistic Booster	Payload to LEO (270 n.mi.) – 89 000 kg
LOX-RPI Winged Booster	Payload to LEO (270 n.mi.) – 99 000 kg

TABLE 11. UPPER STAGE CONCEPTS

Standard OTV (ISP = 470 s)
Main Propellant Weight = 25 242 kg
Burnout Weight = 2890 kg
Optimized OTV
ISP = 470 s
Main Propellant Weight = Variable
Burnout Weight = Variable
Optimized Kick Stage
ISP = 300 s
Mass Fraction = 0.9
Main Propellant Weight = Variable
Burnout Weight = Variable



### **A. Space Shuttle and Required Modifications**

The Space Shuttle is a new class of space vehicle in that it is reusable and can transport payloads to LEO and back. The reuseability of the Space Shuttle has lowered the cost of transporting payloads into space. Also, the Space Shuttle is a manned vehicle, and the airplane like Orbiter has intact abort capability, thus making it safer than previous launch vehicles. The Space Shuttle has a payload capability of 29 483 kg to LEO (296 km circular altitude) [18]. The nuclear waste disposal program could use the basic Space Shuttle with a few minor modifications. Modifications that have been identified are as follows:

(1) A heat exchanger system for dissipation of heat generated by the nuclear waste. This system would include coolant tanks, coolant, coolant lines, and a method of connecting to a portable cooling system on the ground.

(2) A method for blowing the cargo bay doors off in case of a catastrophic Shuttle failure.

(3) An improved stronger landing gear may be required to increase the safety margin on landing heavy payloads.

(4) An improved Remote Manipulator System (RMS) may be required for handling the nuclear waste payload. The current requirements state that RMS can remove and replace a 29 483 kg payload without releasing the payload. Once the payload is released, the requirement is that the RMS can retrieve and place in the cargo bay a payload of 14 515 kg.

### **B. OTV Definition**

Vehicles potentially available for use in transferring nuclear waste from LEO to its final destination are (1) Interim Upper Stage (IUS), (2) storable liquid, (3) cryogenic, and (4) solar electric. The main emphasis of this study is on pure chemical systems; therefore, solar electric propulsion was not investigated. Figure 33 presents the results of a study to determine the effects of upper stage ISP on total program "cost" for the lunar surface mission. Assumptions for this study are: (1) all waste generated by the nuclear power industry between 1975 and 1995 will be reprocessed and transported beginning in 1985 and ending in 2005, (2) two Shuttle launches per mission, and (3) cost assumptions as shown in Figure 33. As can be seen from the graph, a total program savings of approximately  $\$3 \times 10^9$  is realized if Mix 3 is transported via an OTV with ISP = 470 s versus an OTV with ISP = 444 s. The cost of a single OTV tends to decrease with a decrease in engine ISP, but total program cost increases. This increase is due to Shuttle cost overshadowing OTV cost. In light of this information, a cryogenic OTV [19] with an ISP of 470 s was selected as the basic upper stage for the nuclear waste disposal program.



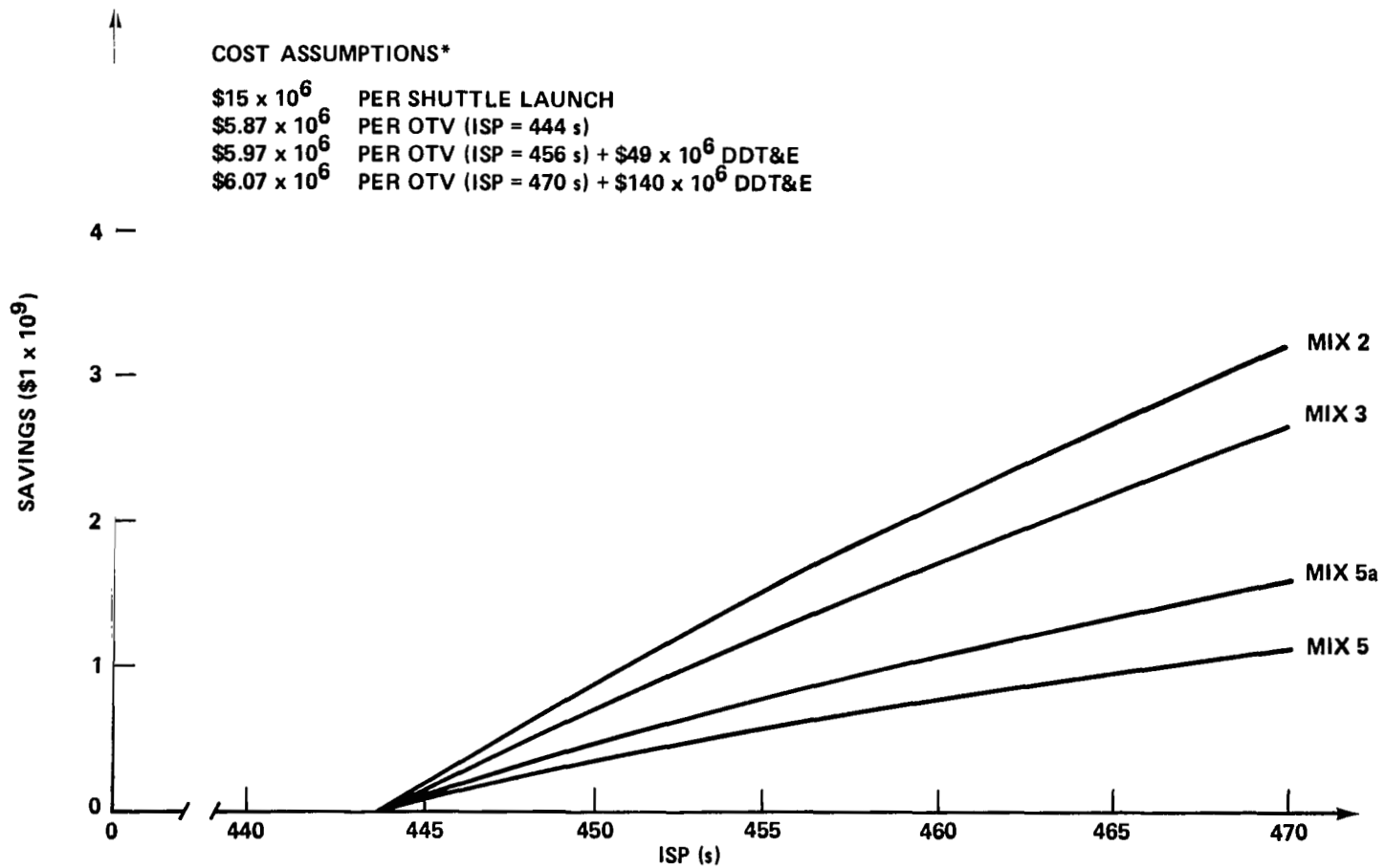

\*PER FLIGHT RATE BASED ON LARGE NUMBER OF FLIGHTS.

Figure 33. Total mission savings versus OTV ISP.



Special OTV features which have been identified for the nuclear waste disposal mission are as follows:

(1) Design of the OTV docking mechanism so that it can release the payload by external command independent of the normal system.

(2) OTV should have a completely redundant attitude propulsion system.

(3) Either a shadow shield should be provided for the OTV avionics or radiation hardened avionics (or both) should be used.

There is approximately 6 months between the first and second burns of the OTV for the solar orbit mission. This time lag between burns is extremely long for a cryogenic stage; therefore, only the first burn will be performed by the OTV. An "optimized" solid stage was assumed for the second burn. This stage has a mass fraction of 0.9 and an ISP of 300 s.

Missions employing the HLLV for the boost phase of the mission require only one launch per mission. The waste package and the OTV are carried by the same HLLV. The OTV used on missions involving the HLLV is an optimized stage. It is based on Reference 19 and is sized to transfer to the final destination, in an expendable mode, the exact amount of waste placed in LEO.

The OTV is conceived as a reusable vehicle but in some options it is to be used in an expendable mode. Significant reductions in weight and cost can be achieved by redesigning this stage as an expendable stage. The redesign work has not been attempted for this study.

### **C. Reusable Versus Expendable OTV**

Current concepts of the high performance cryogenic OTV are designed for reusability; however, Shuttle launch cost is a significant part of this program's cost, thus it may be more economical to fly the OTV in an expendable mode. If the OTV is to be flown in reusable mode, the total program cost (OTV reusable)  $\leq$  total program cost (OTV expendable).

Some insight to this question can be gained by the following mathematical exercise.

Let

$C_O$  = cost of Orbiter/flight

$C_E$  = cost of OTV in expendable mode/OTV



$C_{EOPS}$  = cost of operations for expendable OTV

$C_{ROPS}$  = cost of operations for reusable OTV

$C_K$  = cost of a kick stage

$P_R$  = payload on reusable mission

$P_E$  = payload on expendable mission

$w_M$  = total mass of waste for disposal

$T_{FR}$  = total number of missions (reusable OTV)

$T_{FE}$  = total number of missions (expendable OTV)

$T_{CR}$  = total program cost (reusable OTV)

$T_{CE}$  = total program cost (expendable OTV).

If OTV reusability is to be economically feasible then

$$T_{CR} \leq T_{CE} .$$

Note:

$$T_{CR} = T_{FR} (2C_O + C_{ROPS} + C_K)$$

$$T_{CE} = T_{FE} (2C_O + C_E + C_{EOPS}) .$$

The break-even point for this model is

$$T_{CR} = T_{CE}$$

$$T_{FR} (2C_O + C_{ROPS} + C_K) = T_{FE} (2C_O + C_E + C_{EOPS})$$



or

$$\frac{T_{FR}}{T_{FE}} = \frac{2C_O + C_E + C_{EOPS}}{2C_O + C_{ROPS} + C_K}$$

Note:

$$T_{FR} = \frac{W_M}{P_R} ; \quad T_{FE} = \frac{W_M}{P_E}$$

or

$$\frac{T_{FR}}{T_{FE}} = \frac{P_E}{P_R}$$

$$\frac{P_E}{P_R} = \frac{2C_O + C_E + C_{EOPS}}{2C_O + C_{ROPS} + C_K}$$

This is an expression relating the ratio of the payloads to program cost. Making the following cost assumptions:

$$C_O = \$15 \times 10^6$$

$$C_E = \$5.24 \times 10^6$$

$$C_K = 0$$

$$C_{ROPS} = \$5 \times 10^6$$



$$C_{EOPS} = \$5 \times 10^6$$

then

$$P_R/P_E = 0.87.$$

This means that the reusable payload must be 87 percent of the expendable payload if reusability is to be economically feasible. For destinations covered in this study:

	<u>Lunar Landing</u>	<u>HEO<sup>6</sup></u>	<u>Solar Orbit<sup>6</sup></u>	<u>Solar Escape</u>
$P_R/P_E$	0.80	1	1	0

This model is a very simple one, and assumptions have been slanted to make reusability look as good as possible. Reusability of the OTV will be assumed only for the HEO mission and the solar orbit mission.

#### **D. Shuttle Derived Heavy Lift Vehicles**

Most of the emphasis has been on the Space Shuttle as the launch vehicle. It will be available, it is reusable, it is man rated, and it has a unique abort capability which utilizes the glide capability of the Orbiter. However, any improvements in payload capability can be effectively utilized in the space disposal of nuclear waste. Several Shuttle-derived HLLV configurations have been investigated by NASA for use in other programs [20]. These launch vehicles have payload to LEO capabilities ranging from 68 000 to 120 000 kg. Since the HLLV's have a payload to LEO of more than twice the Shuttle, only one HLLV would be required per mission, i.e., both waste package and the OTV are carried on one vehicle. Thus, use of a HLLV would reduce the launch rate by a factor of 2 or more.

An attractive mission scenario would be one that employs the Space Shuttle during the first few years of waste disposal when the required launch rate is low ( $\leq 26$  per year) and then phases to the HLLV, if it becomes available, later in the program. Launch rates for such a mission are discussed in the next section.

---

6. OTV capability exceeds Shuttle capability.



## E. Traffic Analysis

A large portion of the cost of disposal of nuclear waste in space is the cost of transportation into space. This section presents in tabular and graphical form the number of flights necessary to transport the waste created by the U.S. Nuclear Power Industry in the period 1975 to 1995. Assumptions for this study are as follows:

(1) Amount of waste based on April 1977 ERDA estimates of U.S. nuclear power generating capacity [5]. Figure 1 shows the generating capacity, while Figure 2 presents the amount of waste produced for the various mixes (see Section II for discussion of the mixes).

(2) Waste will be reprocessed and will be available for space disposal 10 years after discharge from the reactor. This is an unrealistic assumption in some cases because there is currently no reprocessing in the U.S.; however, we are only determining the number of flights required, thus the year in which the program starts is not important. Some change in the number of flights will occur as the waste ages due to lighter shielding requirements but this will be insignificant.

(3) Vehicles used and destinations considered are discussed in Sections VIII and III.

Tables 12 through 16 present weight statements for the five launch vehicles. A weight statement is included for each destination in combination with Mixes 3, 5, and 5a. Two Shuttle launches are required for each disposal mission. One Shuttle transports waste only and the other transports an OTV and, if necessary, a solid stage. All of the HLLV's transport the waste and the OTV on one flight.

Cost of transporting waste into space is somewhat dependent on the total number of flights required. Total number of flights is dependent on type of launch vehicle, waste mix, and destination. This does not mean that the combination of destination, waste mix, and launch vehicle with the fewest number of flights will be the least expensive. There are other factors to be considered, i.e., cost of research and development of launch vehicles, cost of reprocessing, and most important the safety factor. Although the total number of launch vehicle flights is not the only factor to be considered when selecting a mission scenario, it is certainly an important factor, thus, total number of flights required for the various combinations of launch vehicle, destination, and waste mix is presented in Table 17.

Yearly launch rates for various combinations of launch vehicle, waste mix, and destination are presented in Figures 34 through 37. Figure 34 presents graphically launch rates for the lunar surface mission, the three mixes, and a Shuttle launch vehicle or when Shuttle launch rates become high, a Class II winged booster HLLV. Two facts to be noted are: (1) more reprocessing — fewer flights and (2) if a HLLV is available 6 to 10 years into the program launch rates remain reasonable low. Figure 35 depicts yearly



TABLE 12. SHUTTLE WEIGHT STATEMENT (kg)

SHUTTLE	MIX 3				MIX 5				MIX 5A			
	LSL	HEO	SOL	ORB	LSL	HEO	SOL	ORB	LSL	HEO	SOL	ORB
TOTAL PL	29483	29483	29483	29483	29483	29483	29483	29483	29483	29483	29483	29483
WASTE	4408	4408	687	4408	4510	4510	687	4510	4436	4436	687	4436
SHIELD	8941	8941	2896	8941	9416	9416	3025	9416	8959	8959	2884	8959
CLAD	331	331	92	331	336	336	92	336	332	332	92	332
FINS	70	70	23	70	71	71	23	71	70	70	23	70
AERO PROTECTION	9352	9352	3372	9352	9698	9698	3448	9698	9380	9380	3364	9380
SYSTEM												
COOL SYS	542	542	542	542	542	542	542	542	542	542	542	542
WATER	1392	1392	217	1392	380	380	58	380	1313	1313	203	1313
EJECTION SYS	1400	1400	1400	1400	1400	1400	1400	1400	1400	1400	1400	1400
PALLET	945	945	945	945	945	945	945	945	945	945	945	945
SHROUD												
OTV												
KICK STAGE												
CONTINGENCY	2102	2102	9135	2102	2185	2185	9043	2185	2106	2106	9203	2106
TOTAL FLTS <sup>1</sup>	1078	1078	3634	1078	484	484	2375	484	696	696	3013	696

<sup>1</sup> ONE HALF OF FLIGHTS CARRY WASTE; EXCEPT SOLAR ESCAPE WHERE ONLY 1/3 CARRY WASTE.

TABLE 13. CLASS I STS-DERIVED HLLV WEIGHT STATEMENT (kg)

CLASS I STS - DERIVED HLLV	MIX 3				MIX 5				MIX 5A			
	LSL	HEO	SOL	ORB	LSL	HEO	SOL	ORB	LSL	HEO	SOL	ORB
TOTAL PL	68156	68156	68156	68156	68156	68156	68156	68156	68156	68156	68156	68156
WASTE	5136	8000	1420	6537	5186	8143	1421	6626	5148	8031	1422	6558
SHIELD	9993	13723	4175	11900	10426	14406	4342	12451	9986	13728	4162	11898
CLAD	372	528	148	449	374	536	148	454	372	530	148	450
FINS	76	96	37	86	77	97	37	87	76	96	37	86
AERO PROTECTION	10438	14466	4610	12458	10728	14963	4710	12843	10442	14488	4603	12471
SYSTEM												
COOL SYS	542	542	542	542	542	542	542	542	542	542	542	542
WATER	1622	2526	448	2064	437	686	120	558	1524	2377	421	1941
EJECTION SYS	1400	1400	1400	1400	1400	1400	1400	1400	1400	1400	1400	1400
PALLET	945	945	945	945	945	945	945	945	945	945	945	945
SHROUD	6325	4507	8864	4610	6381	4575	8870	4663	6340	4522	8872	4622
OTV	28354	17859	43551	18833	28630	18174	43580	19086	28425	17928	43590	18892
KICK STAGE				4681				4744				4696
CONTINGENCY	2953	3564	2016	3651	3030	3689	2041	3757	2956	3569	2014	3655
TOTAL FLTS	462	297	1648	363	210	134	769	164	299	192	1086	235



TABLE 14. CLASS II STS-DERIVED HLLV WEIGHT STATEMENT (kg)

CLASS II STS- DERIVED HLLV	MIX 3				MIX 5				MIX 5A			
	LSL	HEO	SOL ESC	SOL ORB	LSL	HEO	SOL ESC	SOL ORB	LSL	HEO	SOL ESC	SOL ORB
TOTAL PL	120660	120660	120660	120660	120660	120660	120660	120660	120660	120660	120660	120660
WASTE	10000	16387	2718	12985	10122	16778	2723	13208	10027	16462	2720	13030
SHIELD	15941	20875	6332	18653	16681	22030	6574	19600	15929	20856	6317	18641
CLAD	635	964	231	790	641	984	232	802	636	968	231	792
FINS	108	138	54	123	108	140	54	124	108	139	54	123
AERO PROTECTION SYSTEM	17047	23995	6725	20537	17563	24928	6872	21240	17056	24032	6717	20558
COOL SYS	542	542	542	542	542	542	542	542	542	542	542	542
WATER	3158	5175	858	4100	852	1413	230	1112	2968	4872	805	3857
EJECTION SYS	1400	1400	1400	1400	1400	1400	1400	1400	1400	1400	1400	1400
PALLET	945	945	945	945	945	945	945	945	945	945	945	945
SHROUD	11564	8355	16200	8371	11693	8531	16231	8500	11591	8389	16213	8397
OTV	54557	36220	81470	37011	55210	37075	81632	37635	54695	36384	81534	37136
KICK STAGE				9200				9355				9231
CONTINGENCY	4763	5564	3185	6003	4903	5894	3225	6197	4763	5671	3182	6119
TOTAL FLTS	237	145	874	183	107	65	401	82	154	93	567	118

TABLE 15. BALLISTIC HLLV WEIGHT STATEMENT (kg)

BALLISTIC HLLV	MIX 3				MIX 5				MIX 5A			
	LSL	HEO	SOL ESC	SOL ORB	LSL	HEO	SOL ESC	SOL ORB	LSL	HEO	SOL ESC	SOL ORB
TOTAL PL	102111	102111	102111	102111	102111	102111	102111	102111	102111	102111	102111	102111
WASTE	8243	13232	2257	10619	8338	13518	2261	10789	8264	13289	2259	10654
SHIELD	14011	18845	5581	16562	14645	19853	5797	17376	14001	18841	5567	16555
CLAD	541	803	203	667	546	817	203	676	542	806	203	669
FINS	98	124	48	111	98	125	49	112	98	125	48	111
AERO PROTECTION SYSTEM	14791	20807	5984	17804	15228	21586	6115	18397	14799	20840	5977	17823
COOL SYS	542	542	542	542	542	542	542	542	542	542	542	542
WATER	2603	4179	713	3353	702	1138	190	909	2446	3933	668	3153
EJECTION SYS	1400	1400	1400	1400	1400	1400	1400	1400	1400	1400	1400	1400
PALLET	945	945	945	945	945	945	945	945	945	945	945	945
SHROUD	9684	6924	13610	7005	9786	7055	13632	7104	9707	6950	13621	7025
OTV	45105	29322	68051	30350	45616	29949	68164	30829	45218	29447	68105	30449
KICK STAGE				7544				7663				7568
CONTINGENCY	4148	4988	2777	5209	4265	5183	2813	5369	4149	4993	2776	5217
TOTAL FLTS	288	179	1052	223	131	80	483	101	186	116	683	144



TABLE 16. CLASS II WINGED HLLV WEIGHT STATEMENT (kg)

CLASS II WINGED HLLV	MIX 3				MIX 5				MIX 5A			
	LSL	HEO	SOL ESC	SOL ORB	LSL	HEO	SOL ESC	SOL ORB	LSL	HEO	SOL ESC	SOL ORB
TOTAL PL	114313	114313	114313	114313	114313	114313	114313	114313	114313	114313	114313	114313
WASTE	9394	15279	2560	12164	9507	15632	2565	12367	9418	15347	2562	12205
SHIELD	15303	20253	6077	17978	16007	21361	6310	18880	15292	20240	6062	17968
CLAD	603	908	222	748	608	925	222	758	604	911	222	750
FINS	104	134	52	119	105	135	52	120	104	134	52	119
AERO PROTECTION SYSTEM	16285	22930	6472	19619	16774	23811	6614	20284	16294	22965	6465	19639
COOL SYS	542	542	542	542	542	542	542	542	542	542	542	542
WATER	2967	4825	808	3841	800	1316	216	1041	2788	4542	758	3612
EJECTION SYS	1400	1400	1400	1400	1400	1400	1400	1400	1400	1400	1400	1400
PALLET	945	945	945	945	945	945	945	945	945	945	945	945
SHROUD	10917	7854	15313	8000	11037	8014	15342	8120	10942	7885	15325	8050
OTV	51297	33800	76874	34698	51900	34570	77018	35270	51426	33947	76934	34814
KICK STAGE			8625				8767				8654	
CONTINGENCY	4556	5443	3048	5634	4688	5662	3087	5819	4558	5455	3046	5615
TOTAL FLTS	252	155	928	195	114	69	426	88	164	100	602	126

TABLE 17. TOTAL NUMBER OF FLIGHTS FOR VARIOUS COMBINATIONS

LAUNCH VEHICLE	MIX 3				TOTAL NUMBER OF LAUNCH VEHICLE FLIGHTS MIX 5				MIX 5A			
	LSL <sup>1</sup>	HEO <sup>2</sup>	SOL <sup>3</sup> ORB	SOL <sup>4</sup> ESC	LSL	HEO	SOL ORB	SOL ESC	LSL	HEO	SOL ORB	SOL ORB
SHUTTLE	1078	1078	1078	3634	484	484	484	2375	696	696	696	3013
CLASS I STS - DERIVED HLLV	462	297	363	1648	210	134	164	769	299	192	235	1086
CLASS II STS - DERIVED HLLV	237	145	183	874	107	65	82	401	154	93	118	567
CLASS II BALLISTIC BOOSTER HLLV	288	179	223	1052	131	80	101	483	186	116	144	683
CLASS II WINGED BOOSTER HLLV	252	155	195	928	114	69	88	426	164	100	126	602

- 1 LSL - LUNAR SURFACE LANDING  
 2 HEO - HIGH EARTH ORBIT  
 3 SOL ORB - SOLAR ORBIT  
 4 SOL ESC - SOLAR SYSTEM ESCAPE



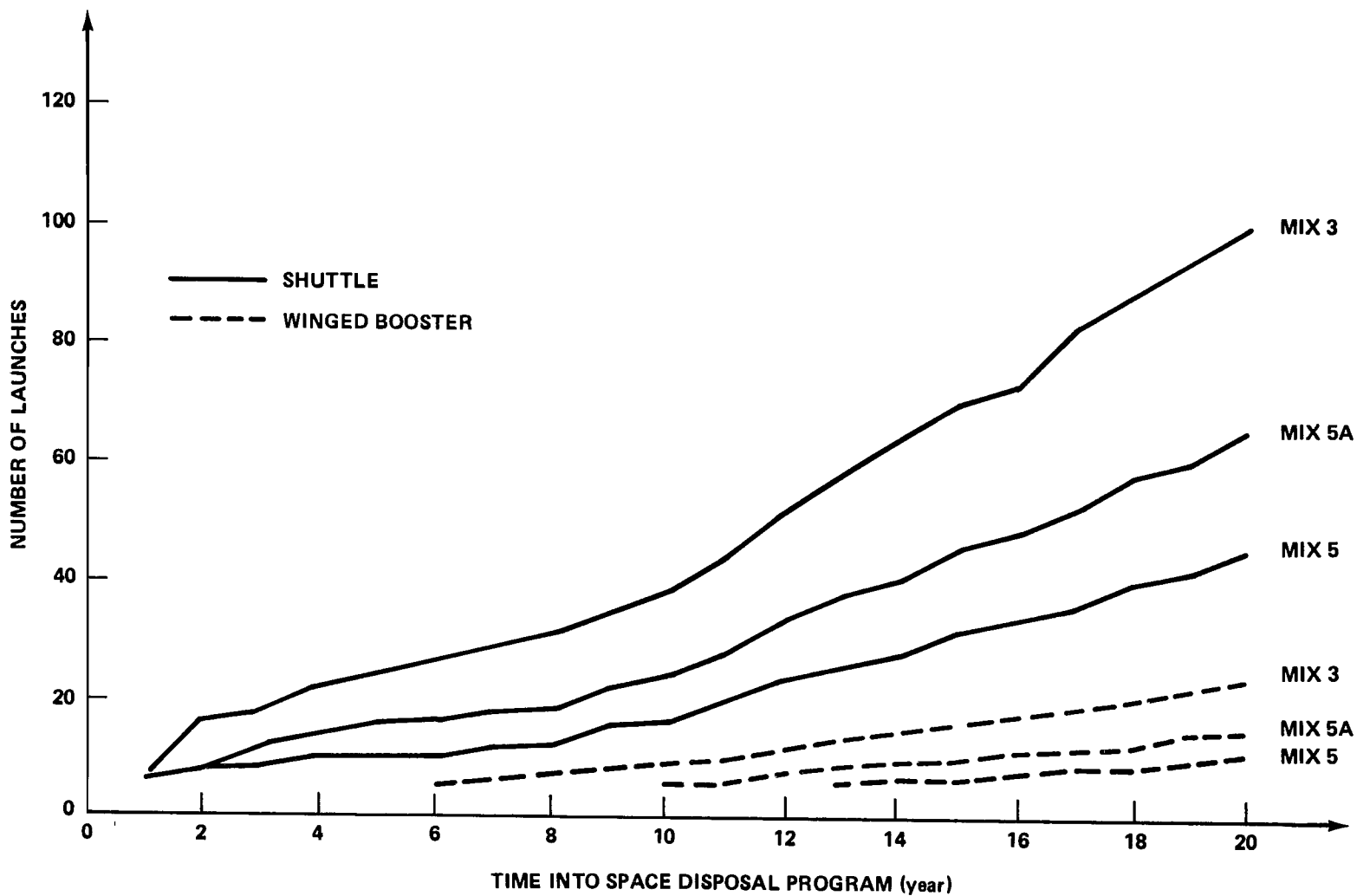

Figure 34. Launch rates for LSL mission.



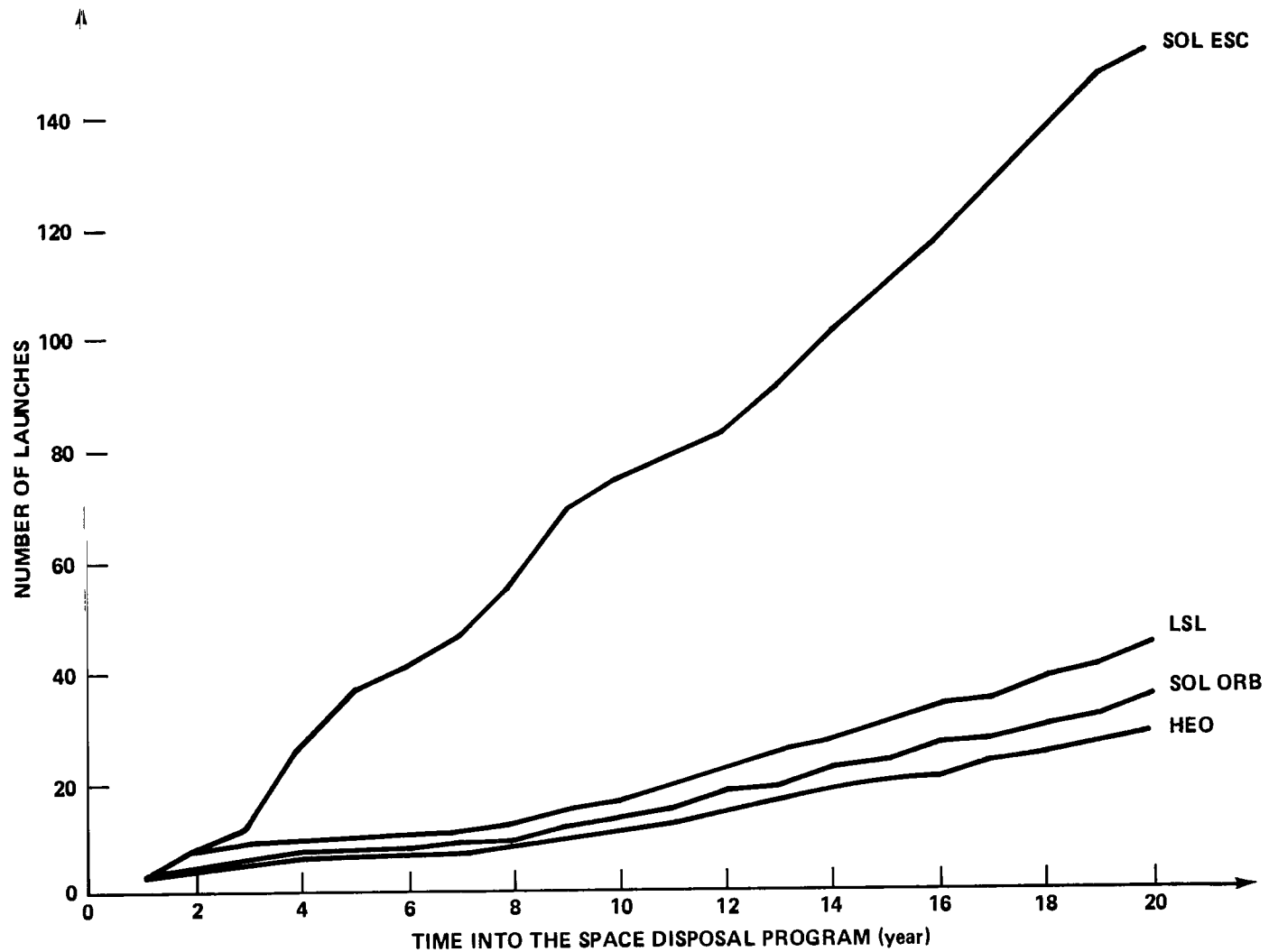

Figure 35. Launch rates for the Class I STS-derived HLLV (Mix 3).



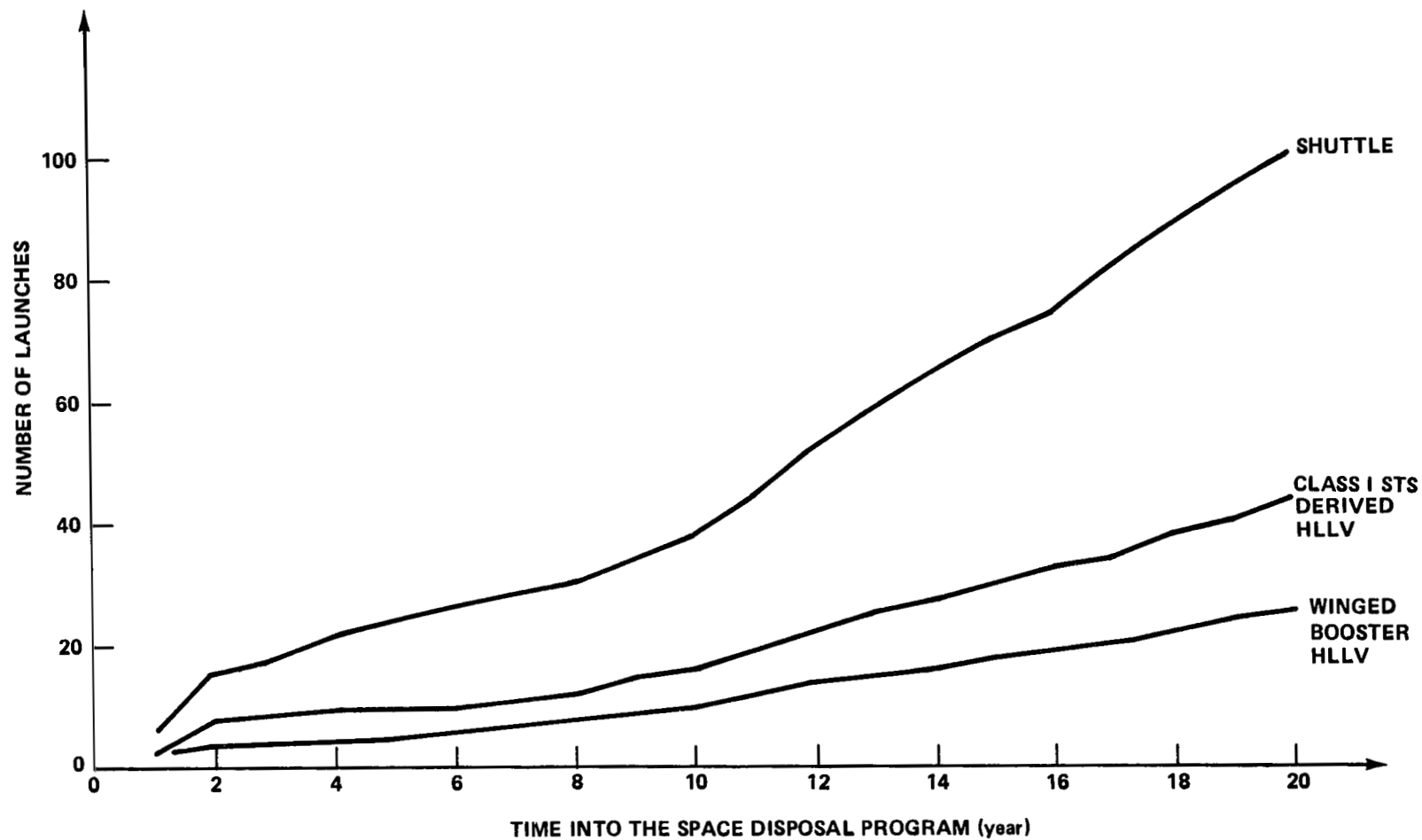

Figure 36. Launch rates for LSL mission (Mix 3).



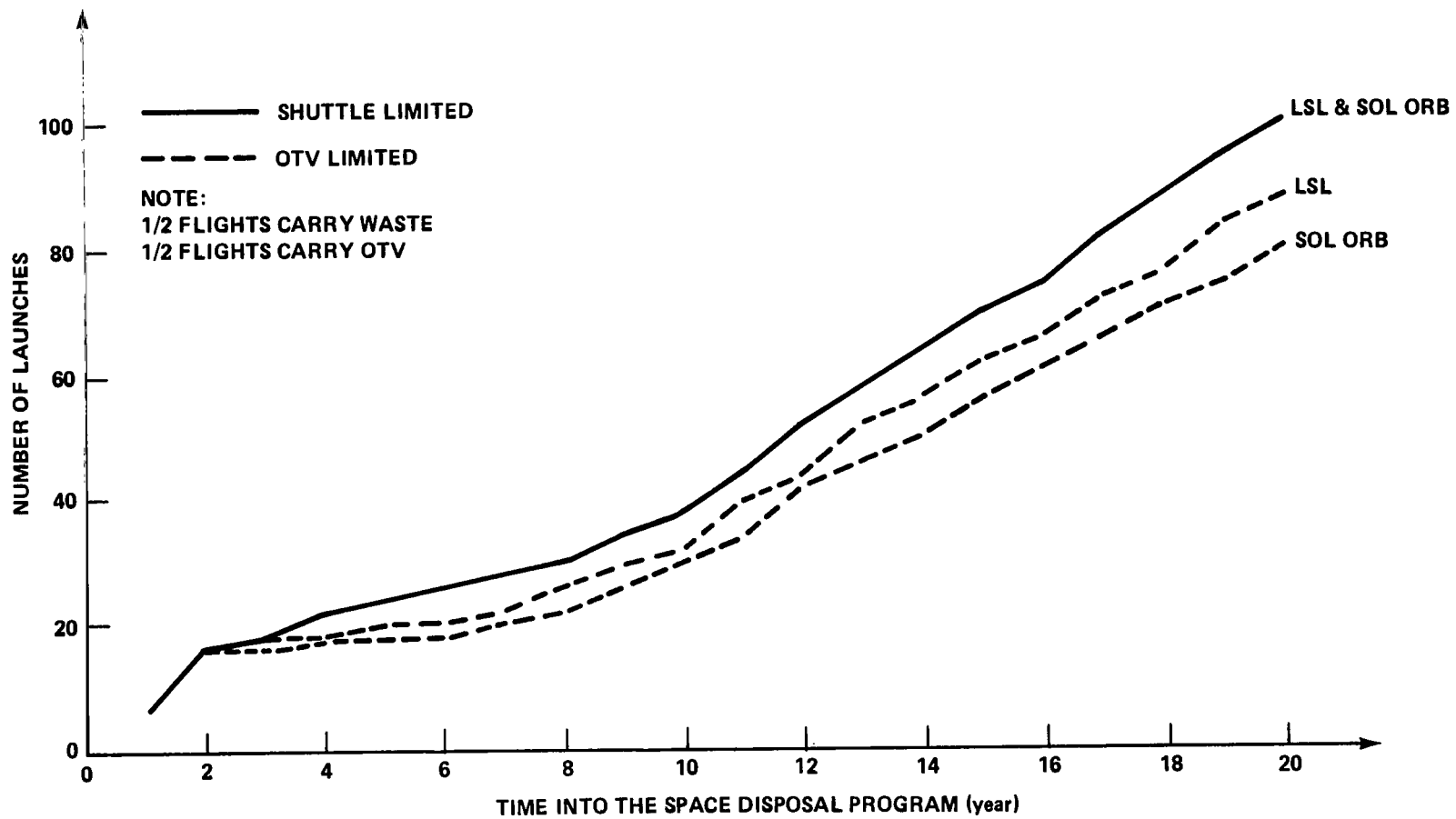

Figure 37. Launch rates for Mix 3.



launch rates for the Class I STS-derived HLLV transporting Mix 3 to the four destinations under consideration. The solar system escape mission has extremely high yearly launch rates; however, based on yearly launch rates the other destinations appear to be viable candidates for final destination. To keep yearly launch rates reasonably low, a launch vehicle like an HLLV will be required for Mix 3. This is demonstrated for the lunar surface mission in Figure 36. Total number of missions required to transport the waste Lunar Soft Landing (LSL), HEO, and solar orbit by the Shuttle/OTV combination are all the same in spite of the fact that total energy required is different for each. This is because the Shuttle can transport to LEO less waste than the OTV can transfer to the final destination. If a reduction in some of the supporting systems could be achieved so that the Shuttle could transport to LEO as much waste as the OTV can transfer to the final destination, a significant, although not spectacular, reduction in yearly launch results. This reduction is shown in Figure 37.



## REFERENCES

1. Feasibility of Space Disposal of Radioactive Nuclear Waste. NASA TM X-2911, NASA-Lewis Research Center, December 1973.
2. Burns, R.E.: Nuclear Energy Waste-Space Transportation and Removal. NASA TM X-64973, NASA-Marshall Space Flight Center, December 1975.
3. Hanrahan, E.J., et al.: United States Uranium Requirements. Presented at Uranium Industry Seminar, Grand Junction, Colorado, October 19, 1976.
4. Kee, C.W., Croff, A.G., and Blomeke, J.O.: Updated Projections of Radioactive Wastes to be Generated by the U.S. Nuclear Power Industry. ORNL/TM-5427, Oak Ridge National Laboratory, Tennessee, December 1976.
5. Alexander, C.W., Kee, C.W., Croff, A.G., and Blomeke, J.O.: Projections of Spent Fuel to be Discharged by the U.S. Nuclear Power Industry. Oak Ridge National Laboratory, Oak Ridge, Tennessee, October 1977.
6. Anonymous: ORIGEN-Isotope Generation and Depletion Code — Matrix Exponential Method CCC-217, Radiation Shielding Information Center (RSIC). Oak Ridge National Laboratory, Oak Ridge, Tennessee, Second ed., May 3, 1976.
7. Etherington, H., ed.: Nuclear Engineering Handbook. First ed., McGraw-Hill Book Co., New York, 1958.
8. Pardue, William M., et al.: Preliminary Evaluation of the Space Disposal of Nuclear Waste. Report No. 8-32391(100), Battelle-Columbus, August 30, 1977.
9. Samsonov, G.V. and Paderno, Yu.B.: Borides of the Rare Earth Metals. Publishing House of the Academy of Sciences (Ukrainian SSR, Kiev), 1961.
10. Samsonov, G.V., ed.: The Oxide Handbook. IFI Plenum, New York, 1973.
11. Weast, R.C.: Handbook of Chemistry and Physics. CRC Press, Cleveland, Ohio, 1973.
12. Shute, Barbara E.: Prelaunch Analysis of High Eccentricity Orbits. NASA TN D-2530, December 1964.
13. Friedlander, Alan L., et al.: Aborted Space Disposal of Hazardous Material: The Long-Term Risk of Earth Encounter. SAI-1-120-676-T8, Science Applications, Inc., Rolling Meadows, Illinois, February 1977.



## REFERENCES (Concluded)

14. Friedlander, Alan L., et al.: Study of the Failure Modes Associated with Earth Reencounter from Aborted Space Missions. Summary Review presented at NASA Headquarters, Science Applications, Inc., Schaumburg, Illinois, October 27, 1977.
15. Carslaw, H.S. and Jaeger, J.C.: Conduction of Heat in Solids. Oxford Press, London, Second ed., 1959.
16. Arnold, E.D. and Maskewitz, B.F.: SDC, A Shielding-Design Calculation Code for Fuel-Handling Facilities. ORNL-3041, Oak Ridge National Laboratory, Oak Ridge, Tennessee, March 1966.
17. Nuclear Waste Disposal Mission Analysis. Northrop Services, Inc., Huntsville, Alabama, Report No. TR-224-1874, December 1977.
18. Space Shuttle Flight and Ground System Specification. JSC-07700, vol. 10.
19. Orbit Transfer Systems with Emphasis on Shuttle Applications 1986-1991. NASA TM X-73394, April 1977.
20. System Concepts for STS-Derived Heavy-Lift Launch Vehicles Study. Boeing Aerospace Company, D180-19845, Contract No. NAS9-14710, September 1976.



1. Report No. NASA TP-1225	2. Government Accession No.	3. Recipient's Catalog No.
4. Title and Subtitle Nuclear Waste Disposal in Space	5. Report Date May 1978	6. Performing Organization Code
7. Author(s) R. E. Burns, W. E. Causey, W. E. Galloway, and R. W. Nelson	8. Performing Organization Report No. M-250	10. Work Unit No.
9. Performing Organization Name and Address George C. Marshall Space Flight Center Marshall Space Flight Center, Alabama 35812	11. Contract or Grant No.	13. Type of Report and Period Covered Technical Paper
12. Sponsoring Agency Name and Address National Aeronautics and Space Administration Washington, D.C. 20546	14. Sponsoring Agency Code	
15. Supplementary Notes Prepared by Systems Analysis and Integration Laboratory, Science and Engineering		
16. Abstract This report presents a summary of a work on nuclear waste disposal in space conducted by the George C. Marshall Space Flight Center, National Aeronautics and Space Administration, and the following contractors: Battelle, Inc.; Northrop Services, Inc.; and Science Applications, Inc. From the aggregate studies, it is concluded that space disposal of nuclear waste is technically feasible.  The preferred baseline is as follows:  Kind of waste considered - Domestic civilian.  Waste mix to be carried - All wastes excluding unburned uranium and reactor cladding hulls. Carrying plutonium is optional.  Waste form - Calcine or calcine in metal matrix.  Launch site - Kennedy Spaceflight Center or a remote complex.  Launch vehicle - Space Shuttle.  Upper stage - LOX/H <sub>2</sub> high performance OTV.  Space destination - Lunar crater or solar orbit.  Safety philosophy - Work around to all system failures.  It is assumed that this report will be used in conjunction with the contractor reports.		
17. Key Words (Suggested by Author(s))	18. Distribution Statement  44	
19. Security Classif. (of this report) Unclassified	20. Security Classif. (of this page) Unclassified	21. No. of Pages 117
		22. Price \$6.50

\* For sale by the National Technical Information Service, Springfield, Virginia 22161



National Aeronautics and  
Space Administration

Washington, D.C.  
20546

Official Business

Penalty for Private Use, \$300

THIRD-CLASS BULK RATE

Postage and Fees Paid  
National Aeronautics and  
Space Administration  
NASA-451



5 1 10, E, 041878 S00903DS  
DEPT OF THE AIR FORCE  
AF WEAPONS LABORATORY  
ATTN: TECHNICAL LIBRARY (SUL)  
KIRTLAND AFB NM 87117

S

**NASA**

POSTMASTER: If Undeliverable (Section 1  
Postal Manual) Do Not Ret