

ATOMIC BATTERY BASED ON ORDERED DUST-PLASMA STRUCTURES

A.V. FILIPPOV, A.F. PAL', A.N. STAROSTIN, V.E. FORTOV¹,
O.F. PETROV¹, P.P. D'YACHENKO², V.A. RYKOV²

UDC 533.9

© 2005

SRC RF TRINITI

(Troitsk, Moscow region, Russia; e-mail: staran@triniti.ru),

¹IHED RAS

(13/19, Izhorskaya Str., Moscow, Russia),

²SRC RF IPPE

(Obninsk, Kaluga region, Russia)

We report the results on creating the physical basis for a new-type atomic battery on the base of ordered plasma-dusty structures. The ranges of parameters, for which the Coulomb crystallization of the dusty plasma in an atomic battery is expected, are determined. Experiments on the photovoltaic transformation of the energy of fast electrons to electric energy are carried out. A dusty plasma excited by the decay products of Cf^{255} or by a proton beam is experimentally investigated.

recombination of formed diatomic xenon ions results in the effective excitation of xenon excimers which emit vacuum ultraviolet (VUV) photons with a wavelength of about 172 nm. These photons fall on a wide band-gap diamond-based photoconverter and generate electron-hole pairs which are separated and develop an emf. Estimates indicate that the total efficiency of a battery utilizing this principle may be as high as 25–35%.

Introduction

At present, small-sized 1–10 kW autonomous sources of electric energy with an operating lifetime of the order of several years are in demand. Such sources are needed for the electric power supply of spacecrafts, automatic weather stations, antisubmarine buoys, and for other similar users [1]. At present, such sources are provided by photoelectric converters of solar energy, thermoelectric sources with fuel elements of Sr^{90} , Pu^{238} , or Po^{210} , and thermionic converters with a U^{235} reactor used as a heat source. All of these sources suffer from a number of disadvantages; in particular, they have a very low efficiency. In addition, a nuclear reactor is very complex in fabrication.

Here, we give the results of investigations aimed at developing the physical principles of a current source for the nuclear-to-electric energy conversion. It is suggested to accomplish this conversion owing to the photovoltaic effect in wide band-gap semiconductors based on CVD of diamond and boron nitride. The operating principle of a novel atomic battery is as follows [1]. High-energy particles, which are formed during the decay of radioactive materials in the form of dust grains, ionize an inert gas such as xenon at a pressure of about an atmosphere or higher. The dissociative

1. Photovoltaic Electric Source

A pictorial diagram of the proposed atomic battery is given in Fig. 1, and the main elements and processes occurring in such a battery are shown in Fig. 2.

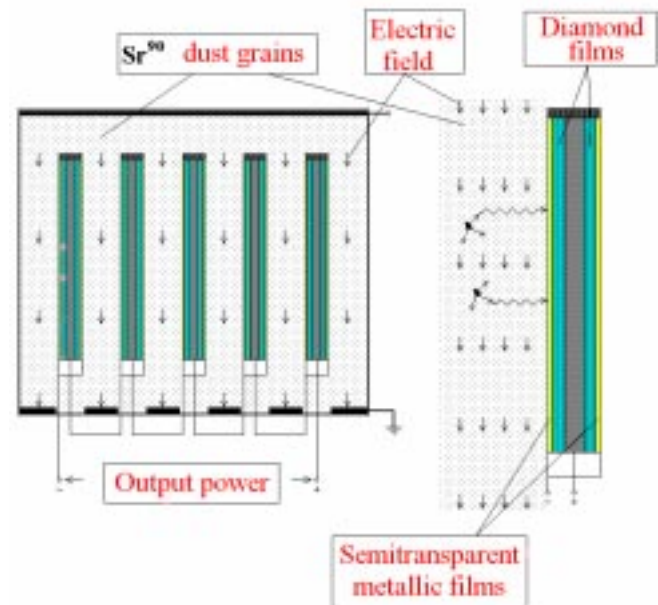

Fig. 1. Pictorial diagram of an aerosol photovoltaic source of electric energy

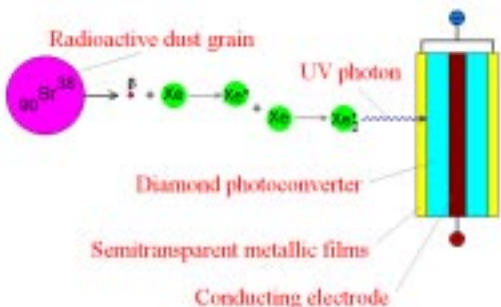

Fig. 2. Scheme of the main components and processes occurring in an aerosol photovoltaic source of electric energy

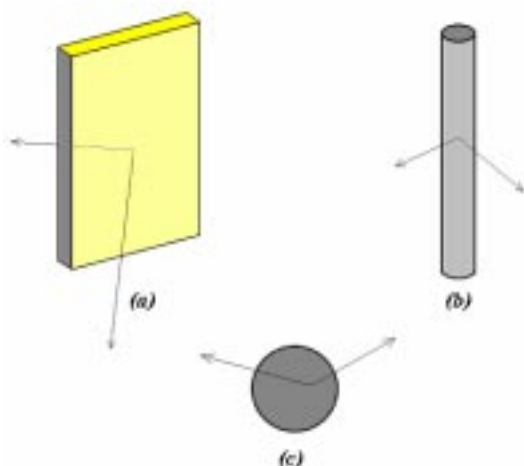
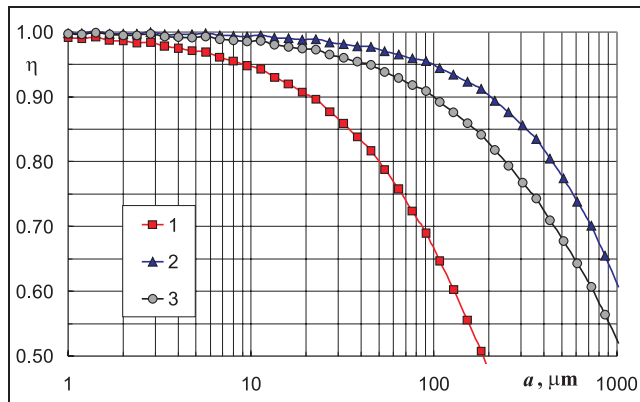

Fig. 3. Possible forms of radio-isotope fuel for a PSEE in the form of thin foils (a), wires (b), and balls (c)

Besides small spherical particles, the radio-isotope fuel may have other geometric shapes such as thin wires and foils (Fig. 3), which was proposed in [2–4]. Fig. 4 shows graphs of the efficiency of energy yield of β -particles which are formed during the decay of Sr^{90} and Y^{90} from the isotope material as a function of the particle size. One can see that the efficiency of energy yield, averaged over the spectra of β -particles, turns out to be higher than 80% even with a particle diameter (thickness) of 100 microns.

Amounts of radioisotope for aerosol PSEE of 1-liter volume required to attain an electric power of 1 W

Isotope	$T_{1/2}$, years	M , g	A , Ci	$n_d r_0^3$, $cm^{-3} \cdot \mu m^3$
Sr^{90}	28.6	4.89	577.6	2.48×10^8
Po^{208}	2.898	0.22	132.1	5.68×10^6
Pu^{238}	87.74	7.19	123.3	8.66×10^7



a

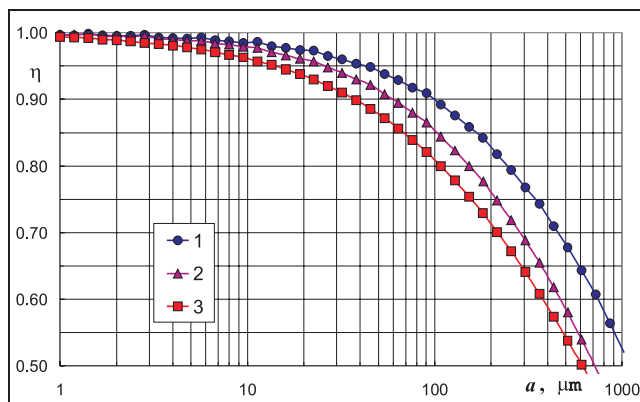

b

Fig. 4. Efficiency of energy yield from strontium in the form of balls (a) and of different geometries (b) as a function of the diameter (thickness) of a particle; a: (1) for β -particles of decay of Sr^{90} , (2) Y^{90} , (3) total efficiency; b – total efficiency of energy yield: for balls (1), filaments (2), foils (3)

The Table gives estimates of the amount of isotope required to generate 1 W of electric power by a photovoltaic source of electric energy (PSEE) with the following assumptions: the efficiency of conversion of the energy of β - or α -decay to VUV-radiation is $\eta_{f1} \approx 0.5$, and the efficiency of conversion of the energy of VUV-radiation to electric energy is $\eta_{pv} \approx 0.5$. In so doing, the total conversion efficiency is $\eta \approx \eta_{f1} \eta_{pv} \approx 0.25$. The table also presents the product of the concentration of dust particles by the cube of their radius for a source of 1-liter volume.

2. Simulation of Dusty Plasma Properties in a Photovoltaic Electric Source

In noble gases, the condition of locality of the electron energy distribution function (EEDF) is violated.

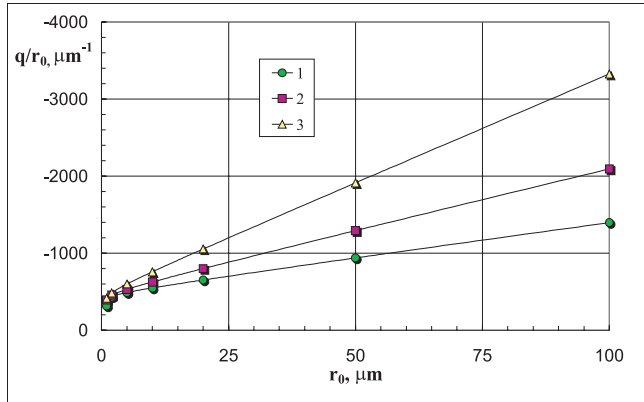

Fig. 5. Dust particle charge in the plasma of a Sr^{90} PSEE for the specific electric power $u = 0.1$ (1), 1.0 (2), and 10 W/l (3)

Therefore, the authors of work [5] developed a nonlocal model of charging dust particles, which takes into account the nonlocality of the EEDF using the nonlocal method of moments [6].

Figure 5 gives the dust particle charge as a function of radius for different values of the specific power of a photovoltaic source of electric energy at a xenon pressure of 10^5 Pa. One can see that no linear function of the dust particle radius, predicted by analytical theory [1, 7, 8], is observed.

Figure 6 gives the dependence of the nonideality parameter of the dusty plasma of a Sr^{90} PSEE on the dust particle radius for the specific electrical power $u = 0.1, 1.0,$ and 10 W/l. This figure shows the curves which separate the solid and liquid phases of a Debye plasma. Above these curves, one can expect the formation of an ordered structure of dust particles of the Coulomb crystal type. One can see in Fig. 6 that the range of existence of the crystal phase increases with the specific power of the photovoltaic source of energy; this is due to a faster decrease in the interparticle spacing with increasing the specific power ($a \propto u^{-1/3}$) compared to the shielding length ($n_{e\infty} = n_{i\infty} \propto u^{1/2}$; therefore, $R_{D,a} \propto u^{-1/4}$). As a result, the structure parameter decreases as $u^{-1/12}$ with increasing the specific power. We can infer from Fig. 6 that, for an ordered structure to form, the dust particle radius must not exceed $4 \mu\text{m}$ at $u = 0.1$ W/l, $8 \mu\text{m}$ at $u = 1$ W/l, and $15 \mu\text{m}$ at $u = 10$ W/l.

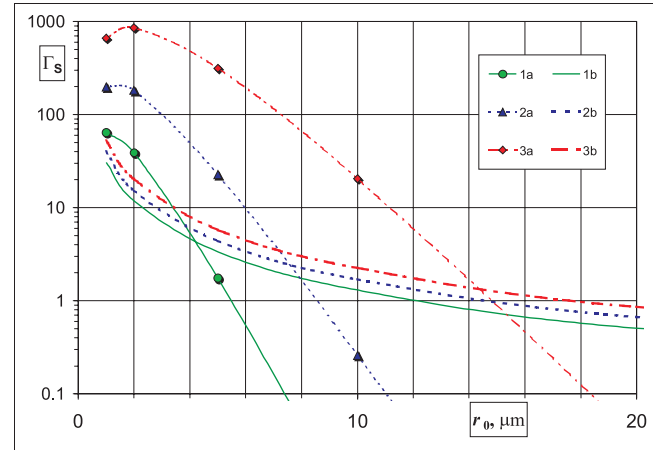

Fig. 6. Nonideality parameter of the dusty plasma of a Sr^{90} PSEE as a function of the dust particle radius for the specific electrical power $u = 0.1$ (1a), 1.0 (2a), and 10 W/l (3a). Curves 1b–3b indicate the critical values of the nonideality parameter, above which the dust component crystallizes

3. Experimental Results of the Study of Dusty Plasma with an External Source of Gas Ionization

The investigations revealed the following.

The experiments in studying the formation of dust structures in a nuclear-excited plasma demonstrated the possibility of a gas-dust mixture to organize into a structure levitating in the gravity field.

The experiments revealed the possibility of using a photoconverter to generate electrical power upon the excitation of a gas medium by a beam of high-energy electrons which simulate β -particles.

β -active isotopes with a half-life of 10 to 30 years are most promising as fuel for an autonomous photovoltaic source of electric energy with a service lifetime of 10 years and longer.

The dust particle size was found to have limitations from both below and above. The limitation from below is associated with the fact that, in the case of a small radius of dust particles, their number per unit volume turns out to be enormous (the radius and concentration of dust particles are related by the need to ensure the specific power of the source on a level of $0.1 \div 10$ W/l that is acceptable from the practical standpoint). As a result, the main process in the loss of diatomic xenon ions becomes the departure to dust particles; in so doing, the energy equal to the ionization potential is used to heat dust particles. This causes a reduction of the efficiency of the PSEE.

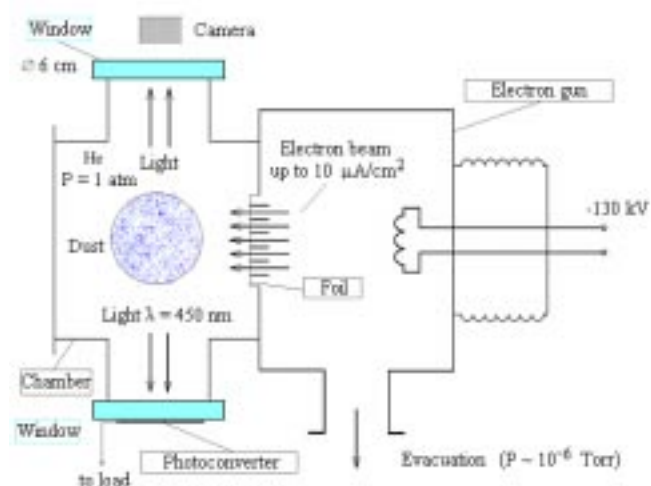

Fig. 7. Scheme of the experimental setup for the study of dusty plasma with gas ionization by a high-energy electron beam

The dust particle size is restricted from above because, firstly, it is difficult to “suspend” large particles in the gravity field and, secondly, their concentration turns out to be low; therefore, the mean interparticle distance becomes large, and the particles cease to interact with one another. Fig. 6 shows the range of parameters, in which the crystallization of the gas-dust mixture in a PSEE is possible.

In order to reduce a loss of energy in the dust component of a gas-dust mixture, it is necessary to raise the pressure as the specific power of a battery increases.

A restraint is imposed on the external electric field because of the Joule heating of a gas. The external field is necessary for the formation and prevention of the sedimentation and deposition of a levitating cloud of dust particles on the source construction elements.

4. Experiments on Studying the Possibility to Use a Photo-Converter for the Electric Energy Generation in Dusty Plasma

The experiments were performed to study the possibility of using a photoconverter to generate electrical power when a gas medium is excited by β -particles. The experiments were performed in a setup consisting of an electron gun with high-voltage supply, a gas chamber with windows to couple out the light radiation, a silicon photoconverter, and diagnostic equipment. A scheme of the experimental setup is given in Fig. 7.

Figure 8 shows the glow of the dust of ZnS:Ag luminophor under the effect of an electron beam.

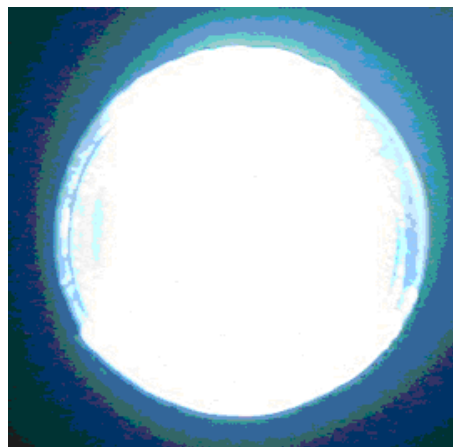

Dust density in a cloud $> 10^6 \text{ cm}^{-3}$

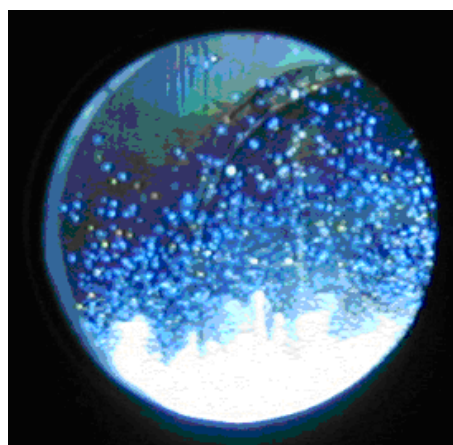

Dust density in a cloud $< 10^6 \text{ cm}^{-3}$

Fig. 8. Glow of ZnS:Ag luminophor under the effect of an electron beam with the following parameters: the size of luminophor particles, about $3 \mu\text{m}$; the dust concentration, up to 10^8 cm^{-3} ; the beam current, $100 \mu\text{A}$; the energy, 120 keV ; equivalent dose, $4 \times 10^4 \text{ Ci}$ (by the energy contribution for a Sr^{90} source). The window diameter, 6 cm

Figure 9 shows oscillograms of the time dependence of the gas glow and the output voltage of a photoconverter. The specific power taken off from the photoconverter turned out to be of the order of $12.5 \text{ mW}/\text{cm}^2$, and the total illuminated area was 1250 cm^2 . Therefore, the total power take-off could be made as high as $\sim 15 \text{ W}$.

5. Investigation of A Nuclear-Excited and Beam-Created Dusty Plasma

The experiments on studying the formation of dust structures in a nuclear-excited plasma revealed the

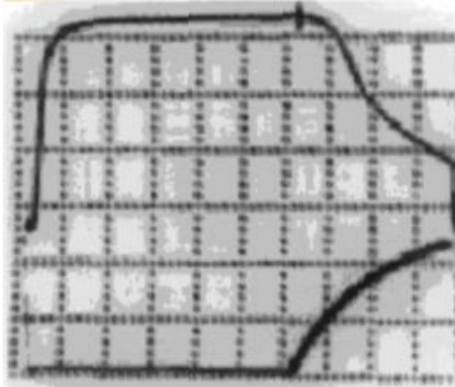

Fig. 9. Oscillograms of the gas glow (lower beam) and the output voltage of a photoconverter (upper beam, 0.1 V/div.). The time-base is 100 μ s/div

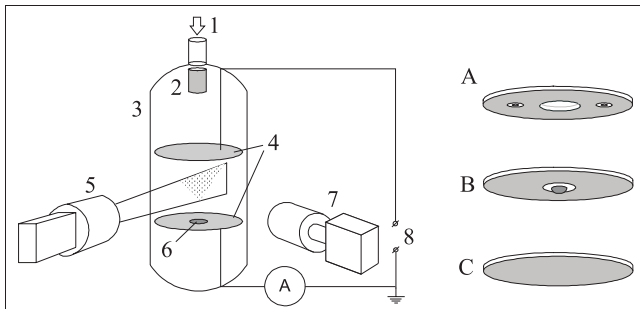

Fig. 10. Experimental setup for the study of a nuclear-excited dusty plasma. 1 — injection of a gas-dust mixture from the system of evacuation and gas-filling, 2 — wire-gauze container with dust particles, 3 — glass walls, 4 — metal electrodes, 5 — laser with a cylindrical lens, 6 — flat radioactive source, 7 — TV camera, 8 — dc source; A, B, and C are forms of a high-voltage electrode

possibility of a gas-dust mixture to organize into a structure levitating in the gravity field. Fig. 10 shows a scheme of experiments with a source of ionization from a Cf^{252} thin layer; Figs. 11 and 12 show the observed structures of dust particles in such plasma. Preliminary experiments were performed using a continuous round beam of protons with an aperture of 15 mm, current of up to 1 μ A, and energy of 1.95 MeV.

The experimental scheme is given in Fig. 13. Dust particles of cerium oxide $1 \pm 0.1 \mu\text{m}$ in size were used. The gas medium was provided by neon or air at a pressure of 0.1 to 1 atm. A “stratification” of the dust component was observed in certain regions of the volume approximately ten seconds after the injection of the gas-dust mixture. That is, from the initial continuous dust cloud, the regions were formed that were not filled with dust particles (Fig. 14,a).

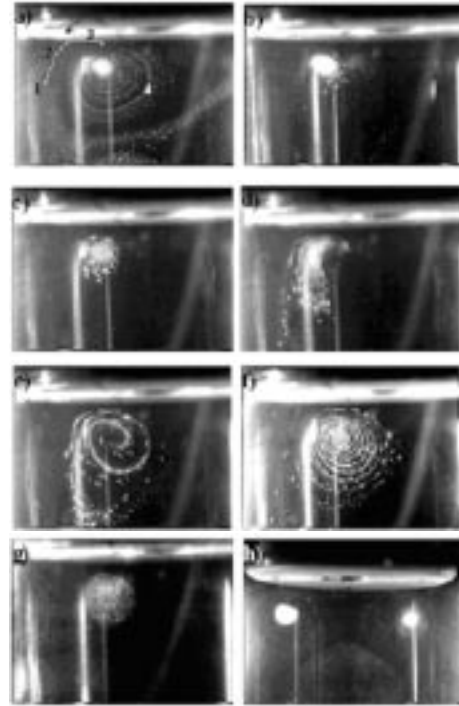

Fig. 11. Vortex motion of Zn dust particles at $U = 187$ V, additional electrode potential of 442 V, neon pressure of $0.4 \cdot 10^5$ Pa, and field of vision of 3.2×2.4 cm; a — 1.5 min after injection of the dust-gas mixture, b — 3 min, c — 4.5 min, d, e, f — variation of the additional electrode potential in the eighth minute from 400 V to 500 V, g — 10 min, h — general view of two vortex structures in the fourth minute (field of vision of 4.2×3.1 cm). Light streaks in the frames are flares on the glass walls of the cell and on the electrodes

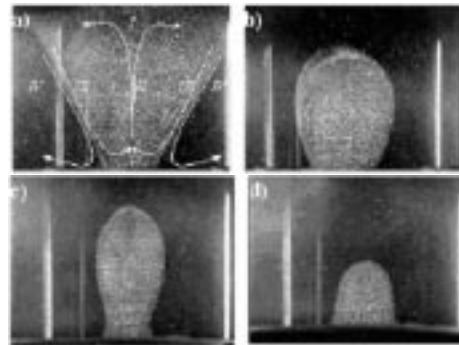

Fig. 12. Evolution of a dust cloud of Zn particles: 2 min after the injection of the dust component (a), 4 min (b), 4.5 min (c), and 4 min 45 s (d). The upper electrode has the form shown in Fig. 10 C; its potential is 152 V. The spacing between the upper and lower electrodes is 3.5 cm. The neon pressure is 0.76×10^5 Pa. The field of vision is 4.2×3.1 cm

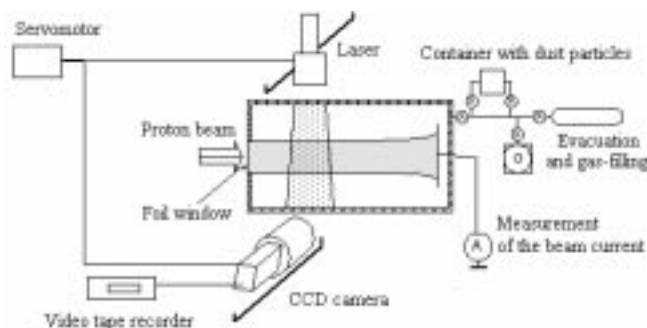

Fig. 13. The scheme of experiment with a proton beam.

A stratification is observed in neon but does not occur in air. After several minutes, the contours of the stratified structure are disturbed because of a continuous loss of particles on the walls. Both in neon and air, the dust component is in motion which covers the entire volume and takes a stable form several seconds after the injection of the mixture. In addition to the electrostatic forces, the motion may be caused by the gas motion due to the heating of a foil and the gas proper, as well as to the transfer of the directed momentum of protons to gas atoms. When the beam is interrupted, the motion is disturbed, the dust particles are deposited downwards, and the stratified structure is slowly distorted during the fall (Fig. 14,*b*); this is indicative of the non-optical nature of the stratification pattern.

The Monte-Carlo method was used to calculate the time dependence of the charge of dust particles in an external electrostatic field in a nuclear-excited plasma which decays under the effect of this field into flows of electrons and ions moving towards opposite electrodes. The vortex dynamic structures of dust particles in a nuclear-excited neon plasma in the presence of an external electrostatic field were theoretically interpreted, and a theoretical model of such a plasma was experimentally verified. The physical mechanisms of levitation of macroparticles were investigated experimentally and theoretically, and the method of molecular dynamics was used to perform numerical investigations, whose results made it possible to explain the singular features of the formation of vortex structures of particles.

Conclusion

We can finally conclude that, for the successful development of adequate scientific principles of atomic batteries based on dust-plasma structures, the investigations must be continued. At present, an

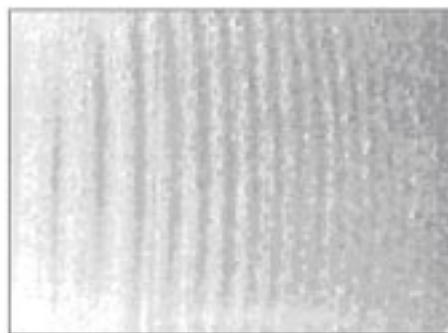

a) under the beam effect

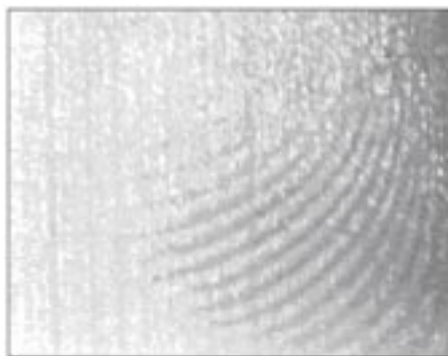

b) the beam is interrupted

Fig. 14. Video images of the observed "stratifications" in the dust component under conditions of vertical scanning by a laser "knife" in a plane passing at a distance of 7 mm from the beam axis

experimental setup is available, and the intense research of the possibility of to create ordered structures in a dusty plasma produced by a stationary beam of high-energy electrons is performed. The experiments are continued to determine the efficiency of conversion of the beam energy to the electric power with the aid of a standard photoconverter using xenon, krypton, argon/nitrogen mixtures, and air. The activities which are aimed at developing a wide band-gap diamond photoconverter have been started; after completing these activities, we plan to perform experiments with xenon. We will also continue the work of developing the theoretical principles and studying the physical processes occurring in the dusty plasma of a battery at elevated pressures.

We thank N.A. Dyatko, Yu.V. Petrushevich and V.V. Pichugin from SRC RF TRINITI, L.V. Deputatova, V.S. Filinov, and V.I. Vladimirov from IHED RAS, and A.V. Khudyakov and K.V. Rykov from

SRC RF IPPE who participated in the implementation of this work.

1. *Baranov V.Yu., Belov I.A., Dem'yanov A.V., et al.* // *Isotopes* / Ed. V.Yu. Baranov. — Moscow: Izdat. — 2000. — P. 626–641 (in Russian).
2. *Hora H., Hopfl R., Prelas M.A.* // *Wide Band Gap Electronic Materials* / Eds. M.A. Prelas et al. — Dordrecht: Kluwer, 1995. — P. 487–509.
3. *Prelas M.A., Popovici G., Khasawinah S., Sung J.* // *Wide Band Gap Electronic Materials* / Eds. M.A. Prelas et al. — Dordrecht: Kluwer, 1995. — P. 463–474.
4. *Prelas M.A., Boody F.P., Zediker M.S.* // *Space Nuclear Power System* / Eds. S. El-Genk and M.D. Hoove. — Orbit Book Co. — 1986. — IV. — P. 267.
5. *Filippov A.V., Dyatko N.A., Pal' A.F., Starostin A.N.* // *Plasma Phys. Repts.* — 2003. — **29**, N3. — P. 190–202.
6. *Ingold J.H.* // *Phys. Rev. A.* — 1989. — **40**. — P. 7158.
7. *Smirnov B.M.* *Aerosols in Gas and Plasma.* — Moscow: Inst. of High Temperatures, USSR Acad. Sci., 1990 (in Russian).
8. *Smirnov B.M.* // *Physics-Uspekhi.* — 2000. — **170**, N5. — P. 453–492.

АТОМНА БАТАРЕЯ НА ОСНОВІ ВПОРЯДКОВАНИХ СТРУКТУР У ЗАПОРОШЕНІЙ ПЛАЗМІ

А.В. Філіппов, А.Ф. Паль, А.Н. Старостин, В.Є. Фортков, О.Ф. Петров, П.П. Дьяченко, В.А. Риков

Резюме

Викладено результати розробки фізичної основи для атомної батареї нового типу, що використовує структури заповненої плазми. Визначено інтервали параметрів, для яких очікується кулонівська кристалізація заповненої плазми. Виконано експерименти по фотоелектричному перетворенню енергії швидких електронів в електроенергію. Експериментально досліджено заповнену плазму збуджену продуктами розпаду Cf^{255} або пучком протонів.