

# Annual Report 2009-10



सत्यमेव जयते

**Government of India**  
**Department of Atomic Energy**



# Contents

	<b>EXECUTIVE SUMMARY</b>	<b>1</b>
<b>Chapter-1</b>	<b>: Nuclear Power Programme-Stage-1</b>	<b>29</b>
<b>Chapter-2</b>	<b>: Nuclear Power Programme-Stage-2</b>	<b>57</b>
<b>Chapter-3</b>	<b>: Nuclear Power Programme-Stage-3</b>	<b>73</b>
<b>Chapter-4</b>	<b>: Advanced Technologies and Radiation Technologies and their Applications</b>	<b>81</b>
<b>Chapter-5</b>	<b>: Basic Research</b>	<b>117</b>
<b>Chapter-6</b>	<b>: Research Education Linkages</b>	<b>157</b>
<b>Chapter-7</b>	<b>: Technology Transfer and Collaborative Programmes</b>	<b>165</b>
<b>Chapter-8</b>	<b>: Infrastructure</b>	<b>169</b>
<b>Chapter-9</b>	<b>: Public Sector Undertakings</b>	<b>173</b>
<b>Chapter-10</b>	<b>: Other Activities</b>	<b>179</b>
<b>Chapter-11</b>	<b>: Implementation of Persons with Disabilities (Equal Opportunities, Protection of Rights &amp; Full Participation) Act, 1995</b>	<b>197</b>
<b>Chapter-12</b>	<b>: Citizens' Charter</b>	<b>201</b>
<b>Annex-I</b>	<b>: The Organisation</b>	<b>i</b>
<b>Annex-II</b>	<b>: Replies to Audit Observations</b>	<b>iv</b>
<b>Annex-III</b>	<b>: Representation of SCs, STs And OBCs</b>	<b>vi</b>





*“For the full industrialization of the underdeveloped countries, for the continuation of our civilization and its further development, atomic energy is not merely an aid, it is an absolute necessity.*

*The acquisition by man of the knowledge of how to release and use atomic energy must be recognized as the third epoch of human history”.*

*(Dr. Homi Bhabha, as President of the International Conference on Atomic Energy for Peaceful Uses at Geneva in 1955)*



# Executive Summary

The year 2009-10, the birth centenary year of the founder of the Indian Atomic Energy Programme -- Dr. Homi Jehangir Bhabha, has witnessed landmark achievements, impressive growth in programmes, and major initiatives of the DAE organizations. All these cover a wide spectrum of the atomic energy programme in India, as described in the following text.

## **NUCLEAR POWER PROGRAMME : STAGE-I**

The Nuclear Power Corporation of India Ltd. (NPCIL), a public sector undertaking of DAE, is responsible for the design, construction, commissioning and operation of nuclear power reactors. The Company now operates eighteen reactors (2 boiling water reactors and 16 pressurised heavy water reactors) with a total capacity of 4340 MW. It is also engaged in the construction of four nuclear power reactors at three project sites, totaling 2440 MW capacity.

## **Operational Highlights**

NPCIL registered more than 310 reactor years of safe operation till December 31, 2009.

Generation of electricity from nuclear power plants was 17,016 million units (MUs) during the calendar year 2009. The generation for the financial year 2009-10 (upto December 31, 2009) was 13,543 MUs.

During the calendar year 2009, seven out of fourteen nuclear power reactors in operation registered availability factors above 90%. The overall availability factor for the calendar year 2009 was 88%. For the financial year 2009-10 (upto December 31, 2009) the overall weighted average availability factor for the operating stations was 91%.

RAPS-2, under IAEA safeguards, was fuelled with imported fuel and re-synchronised to the grid on September 1, 2009 after completion of enmasse feeders replacement (EMFR). This complex and technologically advanced project was carried out

with entirely indigenously developed technology. Since its synchronization, the unit operated at 88% capacity factor and 96% availability factor (till end December, 2009).

Enmasse Coolant Channel Replacement (EMCCR) and Upgradation jobs on NAPS-2 were completed and the unit start up was linked to fuel supply. The EMCCR work on KAPS-1 progressed as per schedule. .

RAPS-4 recorded 394 days of continuous run on June 15, 2009 (May 17, 2008 to June 15, 2009). So far four reactors KGS-1&2, RAPS-4 (twice) and KAPS-1 have recorded uninterrupted operation for more than a year.

## **Ongoing Construction Projects**

Rajasthan Atomic Power Project-5&6 (RAPP-5&6) was placed in IAEA safeguards during this year as per the separation plan. RAPP-5 was fuelled with imported fuel and it achieved first synchronization to the grid on December 22, 2009. RAPP-6 fuel loading was completed in December, 2009.

For Kaiga-4, the balance works were completed.

Kudankulam Nuclear Power Projects-1&2 (KKNPP-1&2) achieved overall physical progress of 90.8% (Unit-1: 94.2% Unit-2: 85.4%) as on



*Rajasthan Atomic Power Project -5&6  
Main Plant View*

# Executive Summary



*Kudankulam Nuclear Power Projects-1&2*

December 31, 2009. Commissioning activities on Unit-1 were in progress.

## **New Launches**

Consequent on the accord of administrative and financial sanction by the Government, the project works on Kakrapar Atomic Power Project-3&4 (KAPP-3&4, 2x700 MW PHWRs) and Rajasthan Atomic Power Project-7&8 (RAPP-7&8, 2x700 MW PHWRs) were started. The first pour of concrete is planned in June, 2010 and December, 2010 for KAPP-3&4 and RAPP-7&8 respectively.

Pre-project activities such as statutory clearances, land acquisition related activities, etc. on Kudankulam Nuclear Power Project (KKNPP-3&4, 2x1000 MW LWRs) were initiated. In respect of Jaitapur Nuclear Power Projects (JNPP-1&2, 2x1650 MW LWRs) the land acquisition was in advanced stage.

## **In-principle Approval of Sites**

The Government accorded “In principle” approval for five Green Field Sites that include two inland sites (Kumharia, Haryana and Bargi, Madhya Pradesh) for setting up six 700 MW indigenous PHWRs, and three coastal sites

(Haripur, West Bengal, Mithi Viridi, Gujarat and Kovvada, Andhra Pradesh) for setting up eighteen 1000 MW or larger size LWRs based on international cooperation. Sanction for capacity expansion at Kudankulam (to a Capacity of : 6x1000, LWRs) and Jaitapur (Capacity : 6x1650, LWRs) sites was also accorded by the Government.

## **Partnership and Diversification**

NPCIL signed Memoranda of Understanding (MoU) with National Thermal Power Corporation, Indian Oil Corporation, National Aluminium Corporation, Korea Electric Power Corporation (KEPCO) etc., to work together for setting up nuclear power plants in India.

The Corporation also signed an MoU with Larsen & Toubro (L&T) to incorporate a Joint Venture Company to set up an integrated facility in the country for the manufacture of special exotic steels and large size forgings.

The work for preparation of Detailed Project Report for Malshej Ghat (600 MW) hydroelectric project has started based on MoU between NPCIL and Tehri Hydro-electric Corporation.

## **FRONTEND FUEL CYCLE**

The operations under the Front-End Fuel Cycle include mining, milling and processing of ore, and fabrication of fuel. In addition, heavy water production is also an ancillary programme to PHWR programme.

## **Heavy Water Production**

Heavy Water Board continued to supply heavy water to all the pressurised heavy water reactors (PHWRs). The Board is now not only self-sufficient in meeting the domestic demands of heavy water but has also established its visibility in the International market by exporting nuclear grade heavy water to South Korea, China and United States against stiff international competition. HWB has also developed similar capabilities in areas such as speciality



# Executive Summary

chemicals and other stable isotopes.

The capacity utilization of heavy water plants, during the year 2009-10, is expected to touch 108% inspite of the major turn around (MTA) of the plants at Manuguru, Kota and Hazira.

During the year 2009-10, HWB bagged the sixteenth export order of 11 MT to M/s KHNP, South Korea.

## Mineral Exploration

During the report period, the Atomic Minerals Directorate for Exploration and Research (AMD) accelerated the pace of exploration activities with an approach focused to meet the XI Plan targets. The salient achievements of the exploration programme of AMD were as follows:

Over 14,875 tonnes ( $U_3O_8$ ) of additional uranium resources were established in Andhra Pradesh at Tummalapalle and adjoining blocks, Kadapa district, Peddagattu and Chitrial, Nalgonda district, Koppunuru, Guntur district, at Rohil, Sikar district, Rajasthan and Lostoin, West Khasi Hills district, Meghalaya. The country's uranium resources have been updated to 1,40,296 tonnes of  $U_3O_8$ .



*Mussorie Syncline where Khrol limestone has thrust over Tal Group.*

*Black shale + Phosphorite along the thrust contact records uraniferous radioactivity near Sarkhet, Dehradun district, Uttarakhand*



*Modified borehole camera survey unit with CMOS image sensor*

Reconnaissance (5149 sq km) and detailed (112.83 sq km) surveys helped in locating promising uranium anomalies (new/extension) in the Proterozoic and Phanerozoic basins associated with North Delhi Fold Belt, Rajasthan; Tertiary basin, Uttarakhand; Mahakoshal meta sediments, Madhya Pradesh; IOG Basin, Orissa, and Lachhri, Rajasthan.

Over 1,56,790 m drilling (reconnoitory, exploratory and evaluation) was carried out to establish additional uranium resources in the known occurrences and subsurface continuity of mineralisation in the new promising areas.

Significant mineralised intercepts/bands were identified in boreholes drilled at Tummalapalle and adjoining blocks, Kadapa district, Peddagattu, Chitrial, Nalgonda district and Koppunuru, Guntur district, Andhra Pradesh; Deshnur, Belgaum district and Gogi, Gulburga district, Karnataka, and Rohil, Sikar district, Rajasthan.

Geochemical surveys (1685 sq.km) were carried out in different parts of the country for delineating the target areas for detailed investigations. The important anomalous areas identified were in Sikar district, Rajasthan.

Regional magnetic, resistivity surveys, detailed gravity, magnetic, I.P/resistivity and electromagnetic (EM) surveys carried out during the field

# Executive Summary

season helped in deciphering prominent EM conductors along the zone of mineralization at Raghunathgarh, Sikar district, Rajasthan; structurally disturbed low gravity and low resistivity zone coincided with low magnetic at Halbavi-Muktapur sector, Gulbarga district, Karnataka, and Bipolar magnetic anomaly at Kulang- Amarsang- Pormawdar, West Khasi Hills district, Meghalaya.

Reconnaissance (545 sq km) and detailed (4.13 sq km) surveys resulted in location of new occurrences of columbite-tantalite and Beryl bearing pegmatites in parts of Bastar district, Chhattisgarh.

2.880 tonnes of columbite-tantalite and 1.850 tonnes of beryl as by-product were produced at Pandikimal-Jangapara and Bodenar recovery units, Jharsuguda district, Orissa and Bodenar, Bastar district, Chhattisgarh respectively.

New potential heavy mineral zones were identified. A total of 58.88 MT of beach sand heavy mineral resources were estimated. The country's total heavy mineral resources were updated to 942.58 MT.

Development of air borne Time Domain Electro-Magnetic (TDEM) system by IGCAR and BARC for detection of deep seated deposits that do not have any surface manifestations, has added a new dimension to AMD's uranium exploration efforts.

## Uranium Mining and Processing

Uranium Corporation of India Limited (UCIL) produces uranium required for pressurised heavy water reactors. It is presently operating five underground mines (Jaduguda, Bhatin, Narwapahar, Turamdih & Bagjata), one open cast mine (Banduhurang), and two processing plants (Jaduguda and Turamdih) all in Jharkhand state.

With the increased demand of uranium for the country's nuclear power programme, UCIL took up Mohuldih Uranium Mining Project in the Saraikela-Kharsawan district of Jharkhand, Tummalapalle Uranium Mining & Milling Project in Andhra Pradesh and Exploratory Mining at Gogi in Karnataka.

Pre-project activities have started for Uranium ore mining and milling projects at Lambapur in Andhra Pradesh and Kylleng Pyndengsohiong, Mawthabah (KPM) in Meghalaya.

## Fuel Fabrication

During the report period, the Nuclear Fuel Complex (NFC) fabricated and supplied fuel bundles for pressurised heavy water reactors and boiling water nuclear power reactors of NPCIL. Processing of imported uranium material was done to supply fuel for RAPS-2, 5 & 6. Highest ever production of PHWR fuel bundles, Zirconium sponge, PHWR fuel tubes, rod material & Niobium metal was achieved.

The Zirconium Complex at Pazhayakayal, Tamil Nadu was inaugurated following the successful trial production of Zirconium Oxide.

Manufacturing of critical components for various sub-assemblies to meet the commissioning schedules of 500 MWe PFBR made progress. Activities relating to technology development of Oxide Dispersion Strengthened Alloy Clad tubes were carried out for establishing use of these tubes to achieve higher burn up in FBRs.

NFC received an order from M/s. L&T for supply of Incoloy-800 steam generator tubes for 700 MWe PHWR units.

NFC successfully executed an order received from IAEA against global competition for



*Zirconium Complex, Pazhayakayal*

# Executive Summary

manufacture, supply, erection and commissioning of fuel element end-cap welding unit to Turkish Atomic Energy Authority.

Production of natural uranium metal for research reactor fuel fabrication and specific grade uranium metal powder for strategic use, were continued at Trombay.

## BACKEND FUEL CYCLE

### Fuel Reprocessing and Waste Management

All the three Fuel Reprocessing Plants at Trombay, Tarapur and Kalpakkam remained in operation to recover strategic material. At Kalpakkam Reprocessing Plant (KARP), the plant was recommissioned with improved features.

HWB had initiated technology development campaigns centering around three broad areas, i.e. Specialty chemicals such as organo-phosphorus solvents for application in fuel fabrication as well as reprocessing of spent fuel, solvent extraction technology including efficient contacting devices for various applications including stable isotope like Boron-10 used in control & safety mechanisms for fast breeder reactors.

Certain Organo-Phosphorous solvents required for the front and back end of the fuel cycle continued



*Dr. S. Banerjee, Director BARC inaugurating Boron Enrichment Plant (BEP) on July 11, 2009*

to be produced at Talcher facility. These solvents are meeting the international quality standards. The Versatile Solvent Production Plant being set up at Talcher, for production of various types of Organo-phosphorous solvents in batches, was mechanically completed and pre-commissioning progressed. HWP Tuticorin also took up synthesis of various organo-phosphorous solvents.

Based on the know how obtained from the test facilities at HWP, Talcher, setting up of a Technology Demonstration Plant continued at the fertilizer plant of RCF, Trombay for recovery and production of uranium from wet phosphoric acid. The facility was mechanically completed and pre-commissioning activities were in progress.

The Waste Management Facilities at Trombay, Tarapur and Kalpakkam for storage and treatment of radioactive waste, operated safely.

Advanced Vitrification System at Tarapur provided excellent operational experience for vitrification of high level waste.

## HEALTH, SAFETY AND ENVIRONMENT

The safety performance of all the nuclear power stations was satisfactory during the period of this report.

Waste Management Facilities at Trombay, Tarapur and Kalpakkam were also operated safely.



*Dr. Anil Kakodkar, the then Chairman, AEC inaugurating Elemental Boron Plant (EBP) on July 11, 2009 at Manuguru*



# Executive Summary

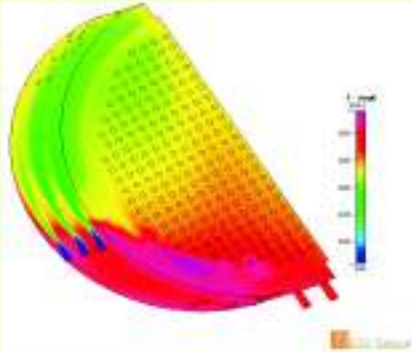

*Temperature distribution Studies :  
Overall temperature contour of  
700 MWe calandria*



*Personal badge dosimeter  
using DTPS/DRPS*



*Optically Stimulated  
Luminescence Dosimeter  
Badge*

Safety analysis codes validation and verification, for containment analysis and severe accident analysis, was carried out using PANDA code in line with IAEA methodologies.

Radiation protection, industrial hygiene and environmental surveillance continued at all the Nuclear Power Plant sites, BARC, and other facilities of DAE.

The releases of radioactivity and effluent from nuclear power plants were maintained at far lower levels than the limit specified by the Atomic Energy Regulatory Board (AERB). The occupational exposures of the employees were also maintained within the stipulated limits of exposures.

At BARC, a new process was developed for growing cesium iodide crystals for radiation detectors. Other developments included radon/thoron progeny sensor based Personal Badge Dosimeter for inhalation dosimetry of workers of uranium mining and thorium processing facilities, population dosimetry in high background radiation areas of Kerala, and optically stimulated luminescence Dosimeter Badge (based on Al<sub>2</sub>O<sub>3</sub>:C) and Badge Reader system.

A centralised National Occupational Dose Registry Network System was setup to maintain and update yearly and life time dose data of all the monitored radiation workers in India.

A Compact Aerial Radiation Monitoring system (CARMS) for large scale mapping of contamination

of ground, was developed for monitoring of ground radiation by unmanned aerial vehicle.

A Real Time Online Decision Support System as a nuclear emergency response system for handling offsite nuclear emergency at Nuclear Power Plants was in operation at the NAPS and at the Emergency Response Centre, Trombay.

Impact Assessment Software developed at Trombay to assess the impact of a nuclear event was integrated with the geographical information system (GIS) for hazard prediction and decision support during response to such events.

To achieve reduction in internal dose to occupational workers of nuclear power station, setting up of a Technology Demonstration Plant for Heavy Water Clean Up (HEWAC) continued at HWP, Kota. The Plant, that is based on design & engineering developed by HWB, was undergoing pre-commissioning.

BARC developed a new Indian Environmental Radiation Monitoring Network (IERMON) system that consists of multiple radiation detectors for redundancy, and extended range of measurement.

The environmental baseline study of uranium mining project at K-P Mawthab (Meghalaya) was completed. Twenty Automatic Weather Stations (AWS) developed by ISRO, were installed at various sites of DAE under ISRO-BARC collaborative research programme.

The Environmental Management System (EMS)

# Executive Summary



*Mist Cooling System Commissioned at Heavy Water Plant, Kota. This system has eliminated requirement of water for dilution of effluent and has resulted in less effluent generation*

and Occupational Health and Safety Management System (OHSMS) as per ISO-14001: 2004 and IS:18001: 2000 respectively were maintained at all the operating stations.

TAPS-3&4 acquired Integrated Management System Certification (IMS), comprising of ISO 9001:2008, ISO 14001:2004 and IS:18001:2007, from the Bureau Veritas, India, accredited by American National Accreditation Board (ANAB).

## R&D SUPPORT TO POWER SECTOR

The thrust areas of the research and development in NPCIL, undertaken during the year, comprised essentially the need based and application-oriented developments in Nuclear Systems and Electronic Systems.

The R&D support to the Nuclear Power Programme was also provided by the research centres of DAE.

During the report period, BARC completed the design of Tool Delivery System for various tools required for in-service inspection (ISI) for 220 MWe PHWR. An Advanced Drive Machine was designed for in-service inspection of coolant



*UMAC - Operator Interface Programme Data acquisition System*



*Sensor mounted in Fuelling Machine snout*



*Ultrasonic Sensor for UMAC*

channels for 540 MWe PHWRs.

Construction and embedded sensor installation for BARC's Containment (BARCOM) Test Model at Tarapur was completed.

# Executive Summary

For NTPC, BARC developed an automation system for Boiler Tube Inspection.

At RRCAT, following laser based technologies were developed for power reactors :

- Laser cutting technique with improved fixtures was deployed for cutting of 612 bellow lip weld joints and 78 numbers of 18 mm thick studs of shock absorber assembly yoke, during en-masse coolant channel replacement of KAPS-1 reactor.
- The laser cutting technique was also deployed for cutting out a piece of inconel from inside the steam generator tube at NAPS-2 reactor for inspection of leaky tubes, at a distance of 783 mm from the base of the tube.
- A prototype machine vision based automated inspection system was designed and developed for quality assurance of the cylindrical fuel pellets (12-15 mm diameter and 15-25 mm length) used in PHWR.

## NUCLEAR POWER PROGRAMME : STAGE-II - Fast Breeder Reactors

The second stage of the nuclear power generation programme is geared towards setting up of fast reactors. These reactors produce more fuel than they consume.

The Indira Gandhi Centre for Atomic Research (IGCAR) is engaged in the design and development of liquid sodium cooled fast breeder reactors, along with associated fuel cycle technologies. At IGCAR, the fast reactor programme is supported by research and development in a variety of disciplines including reactor engineering, chemistry, metallurgy, material science, safety and instrumentation. The Fast Breeder Test Reactor at Kalpakkam, also caters to technology development related to fast reactors.

The indigenously developed fast breeder reactor technology has entered the commercial domain. As a part of the Fast Breeder Reactor Programme of DAE, a 500 MWe Prototype Fast Breeder Reactor (PFBR) is being constructed at Kalpakkam by Bharatiya Nabhikiya Vidyut Nigam Limited

(BHAVINI). This reactor is based on the design developed at IGCAR.

BARC contributes to the research and development of fuels for fast reactors, technology for reprocessing of fuels, waste management and health and safety of the work force.

## Prototype Fast Breeder Reactor

During the period of report, the construction of Reactor Vault for PFBR, which houses all the nuclear components, was completed. After successful completion of all the load test and mock trials, the PFBR's Main vessel (12.9m dia and 12.8m tall weighing about 296 tonnes made of 316LN stainless steel) with integrated cooling pipes, core catcher and core support structure was lowered into Safety vessel on 5th December 2009.

The fabrication of large size component like Inner vessel, was completed and Roof slab reached an advanced stage of completion at site. The integration of Grid Plate and Primary Pipe was also completed.

Manufacture of major components such as intermediate heat exchanger, sodium to sodium heat exchanger, diesel generators, control & safety rod drive mechanism (CSRDM) & diverse & safety rod drive mechanism (DSRDM), and other parts were completed and delivered at the site.

Erection of various equipments and piping



*Erection of the Main Vessel of the Prototype Fast Breeder Reactor*



# Executive Summary

related to plant auxiliary service systems were in progress. The civil construction of Nuclear Island Buildings of PFBR was near completion. Balance of Plant (BOP) civil construction was under progress. The structural works for 230 kV Gas Insulated indoor switch yard and erection of equipment of switch yard were completed.

The project has achieved an overall physical progress of 52.5% as on December-2009.

## Fast Breeder Test Reactor

A major milestone for FBTR was completion of the 15th irradiation campaign, with the reactor outlet temperature reaching 482°C and power raising to 18.6 MWt. High power operation time of the reactor was 847 h.

## Fast Reactor Fuel

At BARC, the experimental (U-30%Pu) MOX fuel of PFBR enriched with U-233 saw a burnup exceeding 92,000 MWD/T (megawatt day per

tonne) against the designed burnup of 100,000 MWD/T. The landmark of fabricating 1000th MOX fuel pin for the first core of PFBR was achieved. Fabrication of Axial blanket DDUO2 pellets (6 million pellets) for the first core of PFBR was completed. Safety clearance was obtained for the new welding line for PFBR.



*Core assembly experimental facility*



*Steam Generator Facility, Kalpakkam*

## Fast Reactor Fuel Reprocessing

At IGCAR, vital process equipment such as chopper, dissolver, and centrifugal contactors for the spent fuel reprocessing of FBTR fuel in Demonstration Fast Reactor Reprocessing Plant reached advanced stage of fabrication.

At the Compact Reprocessing facility for Advanced Fuels in Lead cells (CORAL), Kalpakkam, the spent fuel subassembly from FBTR with a burnup of 155 GWd/t was reprocessed and the fissile material was re-fabricated as fuel and

# Executive Summary



*Compact Reprocessing facility for Advanced Fuels in Lead cells (CORAL), Kalpakkam*

loaded back into the reactor. This marked the successful closing of the fast reactor fuel cycle.

Selective extraction of cesium and strontium from waste radioactive solutions, was successfully carried out at Kalpakkam.

The engineering scale Demonstration Facility for pyroprocessing studies reached an advanced stage of commissioning. Advanced PUREX, was found to have enough potential for isolation of Neptunium, Plutonium and Technetium in a single-process cycle based on highly efficient centrifugal extractors.

## **FBR related Technologies**

A Signal Processing Methodology was developed at IGCAR for detection of defects in expansion bend regions of steam generator tubes during in-service inspection using remote field eddy current technique.

A solid-state explosive cladding welding process was developed to weld Ti-5Ta-1.8Nb alloy to 304L austenitic stainless steel to prevent the formation of intermetallic phases at the interface.

An innovative immersion guided wave based ultrasonic technique was developed for quality assurance of PFBR hexcan.

A scale down model of Safety Grade Decay

Heat Removal (SGDHR) system of PFBR was successfully commissioned to demonstrate the feasibility of passive decay heat removal in PFBR.

Indigenous technology for production of enriched Boron (91% Boron-10) using ion-exchange chromatographic process was demonstrated.

The conceptual design for future oxide fuel reactors was worked out at IGCAR to improve the economics and enhance safety of fast reactors.

The second stage of India's nuclear power programme requires Boron enriched in the isotope Boron-10 at different levels of isotopic purity for applications in control rod, safety rod and neutron detectors.

Country's first industrial scale production facility for Enriched Boron based on exchange distillation was commissioned at Talcher. Another facility based on Ion exchange chromatography was commissioned at Manuguru.

A plant for converting the enriched KBF<sub>4</sub> into elemental Boron based on the process of electrolysis was set up at HWP, Manuguru.

## **NUCLEAR POWER PROGRAMME : STAGE-III - Thorium Based Reactors**

### **Advanced Heavy Water Reactor**

The 300 MWe Advanced Heavy Water Reactor (AHWR) being developed at Trombay, is a thorium fuelled reactor with several advanced passive safety features. The major developments made during the year of report were as follows :

The advanced safety characteristics of this reactor like Passive Containment Cooling System and Gravity Driven Water Pool were verified in a series of experiments carried out in full scale test facilities.

Manufacturing of prototype Fuelling Machine for AHWR and Hydro testing of Magazine assembly and Ram assembly was completed.



# Executive Summary

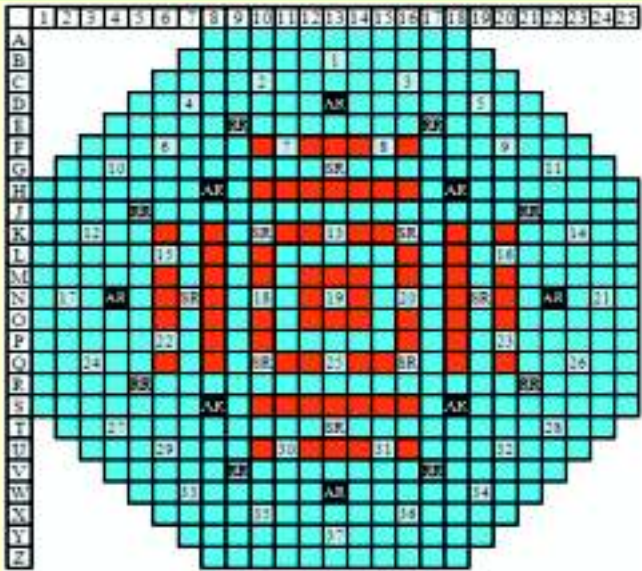

*Initial core configuration of AHWR with (U,Pu)MOX and (Th,Pu)MOX*

To achieve self-sustenance in uranium-233, for AHWR, an alternate fuel cluster was designed at Trombay. A two cycle solvent extraction process for production of greater than 99% pure  $Dy_2O_3$  was successfully developed.

A detection technique based on acoustic signals for steam leakage from AHWR was developed for full scale testing before deployment in AHWR.

Setting up of AHWR Thermal-Hydraulic Test Facility continued at R&D Centre, Tarapur, as a part of the Integrated Test Facility.

The site evaluation report for a candidate site was completed by the Advanced Heavy Water Reactor Plant Siting Committee (APSC) of BARC.

A new version of AHWR named, Advanced Heavy Water Reactor Low Enriched Uranium (AHWR-LEU) that uses low enriched uranium along with thorium as fuel was also designed recently. The reactor has a significantly lower requirement of mined uranium per unit energy produced as compared to most of the current generation thermal reactors. This version of the design can also meet the requirement of medium

sized reactors, in countries with small grids while meeting the requirements of next generation systems.

## Other Reactor Systems

At BARC, research and development work on some innovative reactor systems continued. A Compact High Temperature Reactor (CHTR) is being built as a technology demonstrator for the comprehensive Indian High Temperature Reactor (IHTR) programme. IHTR is planned for non-electrical high temperature process heat applications including production of hydrogen or secondary hydrocarbons as a substitute for primary fossil fuel.

During the report period, the CHTR core and general layout of reactor buildings were prepared. In the CHTR core, a new feature of Burnup Compensation Rods was introduced and detailed physics analysis was done. The initial core of the IHTR was designed by reducing enrichment.

Accelerator Driven Sub-Critical System (ADS) is another innovative reactor system being developed at Trombay. Also, development of various processes & techniques for the Calandria for Sub-Critical Facility of ADS was carried out.

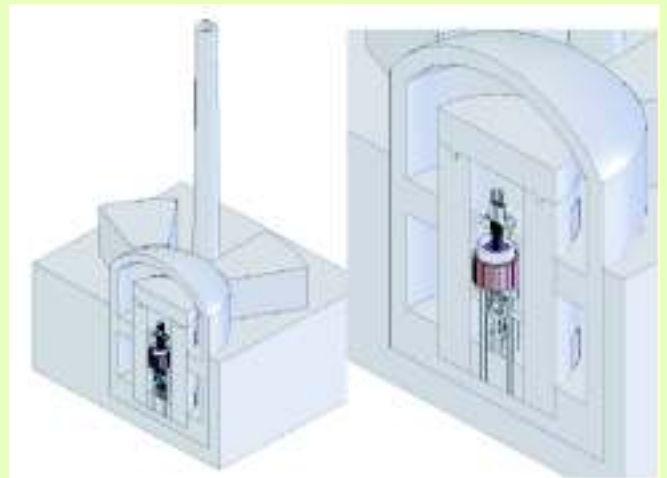

*Solid model of CHTR core and reactor building*

# Executive Summary

## ADVANCED TECHNOLOGIES

### Research Reactors

The three research reactors in operation at Trombay are APSARA, CIRUS and DHRUVA. They are used for research and development, production of radioisotopes, and training of personnel.

Work continued on upgradation of APSARA reactor to a 2 MW reactor with improved facilities for beam tube research, radioisotope production, calibration & testing of neutron detectors, neutron radiography, material testing and bulk shielding experiments.

The Research reactor DHRUVA continued to operate with a high level of safety and an availability factor of over 78%. Characterisation of neutron spectrum of DHRUVA beam hole was completed for the development of a neutron Time of Flight facility in DHRUVA reactor. The reactor is a major facility for radioisotope production and serves as a national facility for neutron beam research. During the period of report, a number of research scholars from various institutions in the country utilized the reactor under the aegis of the

UGC-DAE Consortium for Scientific Research.

At CIRUS, performance of the Desalination Unit integrated with it for utilizing the waste heat, was excellent and supplemented the de-mineralized water requirement of the reactor.

Development of conceptual design of a high flux Multi Purpose Research Reactor for production of high-specific-activity radioisotopes, and providing enhanced facilities for research and development related to nuclear fuel and reactor materials, continued at BARC.

### Accelerators

During the report period, the Variable Energy Cyclotron (VEC) at Kolkata was undergoing modernization and upgradation, to meet the needs of the Advanced Radioactive Ion Beam facility as an injector cyclotron.

VECC is setting up a Superconducting Cyclotron, a Radioactive Ion Beam facility, and a Medical Cyclotron. In the Superconducting Cyclotron (SC), a few internal beams were accelerated up to extraction radius and the facility would become available for experiments once the beam has been extracted out.

Some major projects, pursued at VECC included Advanced Computing and Automation, Advanced Radio Active Ion Beam facility, Enhancement of Superconducting Cyclotron, Augmentation of Technical facilities, etc.

RRCAT completed the plant design for construction of Agricultural Radiation Processing Facility (ARPF) at Mandi Complex, Indore. The safety analysis report was prepared and AERB was approached for stage-2 approval.

At RRCAT, the RF components like 8-way power divider/combiner, 16-way power divider/combiner, low and high power directional couplers and high power 2-way combiner were developed for use in solid state amplifiers for use in Indus machines and proton accelerators.

Setting up of a Lab for calibration of the radiation monitors and maintenance and development work



*De-fuelling Apsara Core*

# Executive Summary

for the radiation safety system, continued. The Lab will have a calibration cell with standard radiation sources.

## Laser Technology Development & Applications

RRCAT and BARC are the research centres that are engaged in the research and development activities relating to lasers and their applications.

At RRCAT, a 500 W average power pulsed Nd:YAG was developed to enhance the laser material processing capabilities. A single transverse mode 1093 nm continuous wave Yb-doped fiber laser with an output power of ~40W was developed for material processing applications. A green laser of 50 W average power with 50 ns pulse duration was demonstrated in a coupled cavity configuration for pumping of dye lasers.

At RRCAT, experiments were carried out on converting the 793 nm Ti:sapphire laser light into its high order harmonics.

Optical coherence tomography (OCT) system was developed and used for tissue imaging in various studies.

An improved technique using vortex beam for optical micromanipulation of biological objects was developed which allowed trapping of the objects to an extended depth inside the medium.

Silica and metal shell nanoparticles were prepared for delivery of potential drugs such as merocycine and chlorine p6 for phototherapy applications.

A Nd:YAG laser based micro-welding technique was developed at RRCAT for the welding of brachytherapy assembly housing a high dose rate 10 curie iridium source for cancer treatment.

Other lasers developed at RRCAT were :

A 20W fibre laser based micro-machining system for fabrication of micro components in stainless steel; A 100W fiber laser based micro-welding system for the fabrication of hermetically sealed components in stainless steel, and a pulsed high power ultra violet light emitting diode based uranium analyzer.

## Robotics

BARC successfully developed a prototype Snake Arm Robot of one meter length and payload capacity of 10 kg, and completed the design and development of a material handling Autonomous Guided Vehicle (AGV) and its control and supervisory software.

A new ROHYTAM hydraulic servo-manipulator was developed. Computer controlled 3D image movements were used for controlling the servo-manipulator.



*Wireless controlled ROHYTAM developed at Trombay*

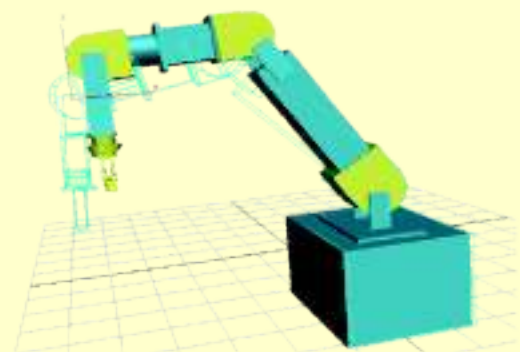

*Soft Master Manipulator of new ROHYTAM*



# Executive Summary

## Recovery of Helium

During the year of report, at VECC, the projects relating to Helium from Soil Airs in Geothermal Areas, and recovery and analysis of helium from hot spring were completed, and non-cryogenic helium purification and seismic related Gas Assaying work continued.

## Computing Technology

At Trombay, two Computing Clusters with a performance rating of 700 GFLOPS (giga floating points operations per second) and 1.4 TFLOPs (tera floating points operations per second) were built for supercomputing technology evaluation. Also, a 1 TFLOP computing cluster was commissioned for specific high pressure physics applications.

IIT-Kanpur and BARC jointly developed a solver software “AnuPravaha” for computational fluid dynamics to create a finite volume based solver to solve Navier- Stokes and associated scalar equations to be used for engineering applications.

As a part of security systems, an advanced entry control system was developed

Programmes And Resources INtegrAtion sYstem (PARINAY), is a web based application for integrating scientific staff, facilities and the scientific programmes, establishing proper linkages. The first phase of development of PARINAY system was completed and was made operational at Trombay.

A parallel high-performance supercomputing cluster was commissioned by IGCAR to cater to the large-scale numerical computational requirements of users in the areas of computational molecular dynamics, material modelling, reactor core calculations & safety analysis, weather modelling and computer aided engineering applications.

At Kalpakkam, an advanced visualization centre, a world-class fully immersive system was commissioned to visualize the models of fast breeder reactors and associated fuel cycle facilities.

A web based On-line Confidential Report system

for BARC officials was also developed and made operational.

## RADIATION TECHNOLOGIES AND THEIR APPLICATIONS

India is a large producer of radioisotopes. The radioisotopes are produced in the research reactors at Trombay, accelerator at Kolkata and the various nuclear power plants of NPCIL.

BARC, VECC and RRCAT are engaged in the development and applications of radiation technologies in the areas of health, agriculture, industry and research.

BRIT produces and supplies a wide range of high quality radioisotope products which include sealed radiation sources for medical and industrial use; radiation technology equipment; radiopharmaceuticals, immunoassay kits, radiochemicals, labeled compounds, labeled biomolecules, <sup>99m</sup>Tc generators, 'cold' kits, oligo nucleotides, self-luminous compounds, and others.

The Board operates plants for radiation sterilization of medical products (ISOMED) at Trombay; Radiation Processing Plant at BRIT Vashi Complex for radiation processing of spices and allied products, runs Co-60 handling facility (RAPPCOF) at Kota, JONAKI Laboratory at Hyderabad, and has other Regional Centres located at Bangalore, Delhi, Kolkata and Dibrugarh. It also runs a Radio-analytical Laboratory at Vashi for detection of radioactivity in products for the benefit of various exporters and importers.

## Isotope Processing

At BARC, production of radioisotopes for medical and non-medical applications continued.

During 2009-2010, more than 52,000 consignments of various isotope products and round the clock radiation processing services were provided by BRIT to customers countrywide, as well as some located abroad. A sales turnover of about Rs. 50.00 crore was achieved.

# Executive Summary

## Agriculture

This year, two new mutant varieties were notified for commercial cultivation taking the total number of mutant varieties developed by BARC using nuclear techniques to 37.

Two new Trombay groundnut varieties TG 39 and TG 51 were released for commercial cultivation by the Ministry of Agriculture, Government of India. 262 quintals of groundnut varieties (TAG-24, TG-37A, TG 38, TPG-41, TLG 45 and TG 51) developed at Trombay, were produced and distributed to 29 seed growing agencies, agricultural universities and farmers.

From Trombay, 210 tissue culture derived banana plants were sent to AKRUTI-CARD for field planting. A miniature commercial tissue culture laboratory for AKRUTI-CARD at Anjangaon-Surji, Amravati was completed for initiating tissue culture production of banana plants.

## Food Processing

Radiation Processing Plant, Vashi provides gamma radiation processing services for spices, ayurvedic raw material and pet feed etc. to more than 130 customers from all over the country. During the current financial year, about 1600 MT of spices and other products were processed till November 2009. During the financial year, the plant is expected to process around 2400 MT spices and allied products yielding revenue of about Rs.1.50 crore.

BRIT signed a tripartite agreement with the Maharashtra State Agricultural Marketing Board (MSAMB) and BARC for service operation of KRUSHAK Irradiation Facility, Lasalgaon, Nashik from this year by MSAMB, for 3 years.

Using this facility, about 130 tonnes mangoes were processed and exported to US by various exporters. The facility was under upgradation for multi-tasking i.e. to convert it into a multi-product processing unit covering wide range of food products requiring low dose to medium dose exposure.

The interest of entrepreneurs in using radiation technology for hygienising and preserving food and allied products is increasing. During the report period, construction of the radiation processing plant of M/s. Jhunsons Chemicals Pvt. Ltd. at Bhiwadi, Rajasthan, was completed and trial run was started. For this irradiator, the 100 kCi sealed radiation source was supplied by BRIT. It is the eighth such plant in private sector in the country.

Radiation technology has also helped India in increasing its exports of food items including to the most developed markets in the world.

## Nuclear Medicine & Healthcare

Development of two radiopharmaceutical agents viz.  $^{177}\text{Lu}$ -EDTMP, as a bone pain palliative and  $^{177}\text{Lu}$ -DOTA-TATE as a radiotherapeutic agent for neuroendocrine tumours, was successfully achieved at Trombay.

During the report period, BRIT supplied 16,000 consignments of ready-to-use radiopharmaceuticals of Iodine-131, Phosphorous-32, Chromium-51 and Samarium-153 and about 54,000 Cold Kits for the formulation of Tc-99m



*BRIT's Clean Room Facility at Radiopharmaceuticals Laboratory*

# Executive Summary

radiopharmaceuticals, to various nuclear medicine centres. 350 Ci of Mo-99 (TCM-2) was supplied for extraction of Tc-99m at hospitals. More than 550 Geltech generators were also supplied by BRIT registering an overall growth of around 60% .

The work of monoclonal antibody (ch TNT 1/B) labeling wing with Iodine-131, for M/s. Peregrine Pharmaceuticals Inc., USA, continued at BRIT. The contract was further extended for 2010. About 6,500 kits of RIA and IRMA were supplied during the year to 300 immunoassay laboratories throughout the country.

At BRIT, a user-friendly IRMA kit for Luteinizing hormone (LH) based on in-house produced magnetizable cellulose particles was developed. Commercial supplies of free T4 RIA kits produced using liquid handling system and an improved T3 RIA kit based on cost-effective liquid phase separation system, were launched. Custom synthesis of several  $^{14}\text{C}$ ,  $^3\text{H}$  and  $^{35}\text{S}$  labeled compounds was carried out successfully. The supply of enzyme, Taq DNA polymerase prepared at JONAKI, Hyderabad was continued through Labelled Compound Laboratory and sales showed a steady increase during the year.

Radio-analytical Laboratory analyzed nearly 2400 samples of various categories and about 250 water samples. Measurement of Cobalt-60 in steel samples for the steel manufacturers and exporters of the country, is regularly carried out in this laboratory and certified.

BRIT supplied 15 teletherapy sources upto December 2009. 1 metre (500 mCi)  $^{192}\text{Ir}$ -Pt wire was supplied to various hospitals and medical research centres for treatment of cancer.

The Regional Radiation Medicine Centre, Kolkata carried out radiodiagnosis, and treatment activities.

Bhabhatron teletherapy unit was dispatched to Vietnam in August, 2009 and the high-capacity telecobalt source for this machine is also ready for shipment.

HWB initiated actions for development of alternate applications of deuterium/heavy water

both in life science as well as technological fields. HWP Baroda continued to supply 3%  $\text{D}_2\text{-N}_2$  gas mixture, to one of the leading Optical Fibre cable manufacturers. Development of methods for production of organic deuterium compounds were in progress at this plant.

Oxygen-18 is one of the isotopes having application in nuclear medicine and biochemical research. It also finds use in positron emission tomography used for detection and staging malignancies. HWB had earlier embarked on distillation route for production of  $\text{H}_2^{18}\text{O}$  at 99.8% purity and engineering was in progress. At HWP, Tuticorin, Oxygen-18 enrichment glassware facility was installed and test runs were conducted.

## Industrial Applications

Isotope hydrological investigations on a few



*Foot Step Electric Converter platform developed at BARC*



# Executive Summary

water resources development and management related issues such as spring development, groundwater augmentation by artificial recharge, groundwater salinity and pollution etc. were initiated by BARC at six sites in Maharashtra.

Under a MoU with Indian Oil Corporation Limited (R&D), Faridabad, a process tomography system was under development at BARC. Transmission-type tomographic imaging technique was developed using an external radiation source and method of reconstruction technique for mapping the approximate attenuation coefficients of materials contained across a specified plane.

At BARC, a wireless gamma probe was developed for industrial gamma scanning and radiometry applications. The same was in use in the field gamma scanning work.

Sealed radiation sources for irradiators comprising of total activity of about 1000 kCi were fabricated, processed and supplied by BRIT for use in various irradiators in the country. More than 1000 fresh Iridium radiography sources were fabricated and supplied with about 40 kCi of Ir-192 activity in the radiography cameras to various users.

Tritium-filled light sources were supplied to BSF as per the MoU signed between BRIT and BSF.

BRIT supplied 48 nos. of radiography exposure devices upto December 2009. BRIT had launched an indigenous 20 Ci Ir-192 portable radiography exposure device in addition to its 35 Ci capacity ROLI-1 radiography camera.

One Blood Irradiator was supplied to RCC, Thiruvananthapuram. Gamma Chamber (GC 5000) was supplied to TINT, Bangkok & Warsaw, Poland. (8 other orders are in the pipeline).

ISOMED offered prompt gamma sterilization services to its customers. About 5900 cubic metres of products were processed during April-December 2009. During the year 2009-10, the plant is expected to process more medical products yielding a total revenue of Rs.3.30 crore.

All the major equipment and machinery for the Hot Cell Laboratories at Medical Cyclotron Facility at Kolkata were received.

Electron Beam (EB) processing of polymer

materials and precious stones continued using ILU-6 EB accelerator. EB processing services were extended to irradiate 13,000 carats of diamonds, 7 lakh pieces of industrial polymer materials and for various BRNS research projects.

## Water Desalination

BARC's Hybrid Nuclear Desalination Demonstration Plant (NDDP) at Kalpakkam comprising Reverse Osmosis (RO) based unit of 1.8 million litres per day, and the Multi-stage Flash (MSF) Desalination Plant of 4.5 million litres per day, has demonstrated that such plants would help in dealing with the shortage of good quality water in water stressed coastal areas. The water from MSF unit was of high quality, containing less than 5ppm total dissolved solids.

The Low Temperature Evaporation (LTE) plant coupled to the research reactor CIRUS, showed that waste heat temperatures even as low as 47 °C can be utilized for seawater desalination, producing distilled quality water. The next generation LTE plant of 50 kilo litre per day capacity, integrated with electro-de-ionization unit was demonstrated for producing ultra-pure desalinated water from seawater for high end applications.



*Hybrid Nuclear Desalination Demonstration Plant (NDDP) based on MSF-RO*

# Executive Summary



*Rural adaptation of BARC developed community level solar photovoltaic driven Ultra-Filtration Water Purification units for villages without electricity*

The barge mounted Mobile Seawater Reverse Osmosis Desalination Plant of 50 kilo-litres capacity, developed by BARC, was registered under the name 'SUJAL'

The next generation Ultra Filtration based iron removal unit, developed by BARC, was deployed at the Central Glass & Ceramic Research Institute, Kolkata for field testing. It produced safe drinking water (with less than 0.3 ppm iron content as per WHO) from contaminated water having iron level upto 6 ppm.

In order to deploy water treatment technologies in un-electrified remote areas, UF units of 100 lph & brackish water RO pilot plants (200 lph), driven by electricity produced through solar photovoltaics (PV) were designed and developed.

Under the BARC Advanced Knowledge and Rural Technology Implementation (AKRUTI) Programme, isotope hydrological investigations on a few water resources development and management related issues such as spring development, groundwater augmentation by artificial recharge, groundwater salinity and pollution etc. were initiated at six sites in Maharashtra.

BARC's efforts towards rejuvenation of springs that are the sources of drinking water in villages on the foothills of Himalayas through use of isotope hydrology techniques, exemplify the important role atomic energy can play in this vital area.

## **BASIC & APPLIED RESEARCH**

The research centres of DAE are engaged in basic research relevant to their programmes. In addition, the autonomous research institutes, supported by the grant-in-aid by DAE, are the centres of excellence in basic research in varied areas of fundamental and applied sciences.

Following are the notable developments in the fields of basic and applied research carried out during the report period, by the DAE's research institutes:

A state-of-the-art High Resolution Resonance Ionization Mass Spectrometer, that has opened up possibilities like detection of rare isotopes for medical diagnostic applications, investigations on isotope selective photoionisation and other frontline research, was set up at Trombay.

Also, as a part of the indigenous development of



# Executive Summary

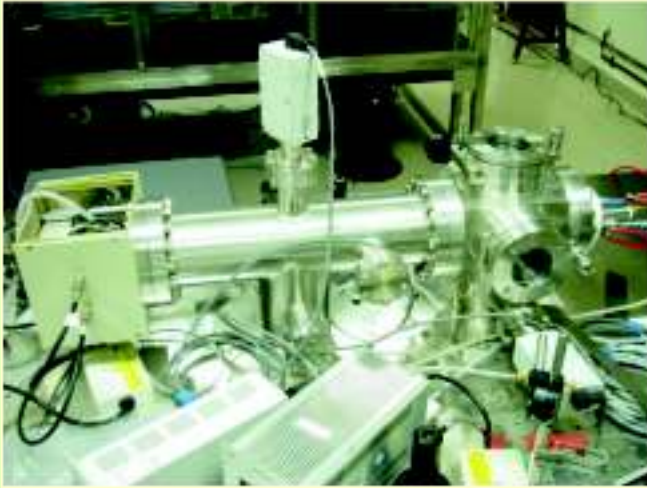

*BARC's Quadrupole Mass Spectrometer*

precision mass spectrometers for DAE programmes, a Quadrupole Mass Spectrometer was designed and developed.

For the first time, using a novel technique, deep sub-barrier cross sections were measured for a weakly bound projectile (Lithium-6) interacting with Platinum-198 target, using the Pelletron facility at TIFR Mumbai.

At RRCAT, the magneto-caloric effect in inter-metallic compounds  $DyPt_2$  and  $GdCu_6$  was studied to explore their potential for near room temperature and low temperature applications.



*$NaCl$ ,  $LiNbO_3$ ,  $Bi_{12}SiO_{20}$  crystal grown using ADC puller developed inhouse by IGCAR*

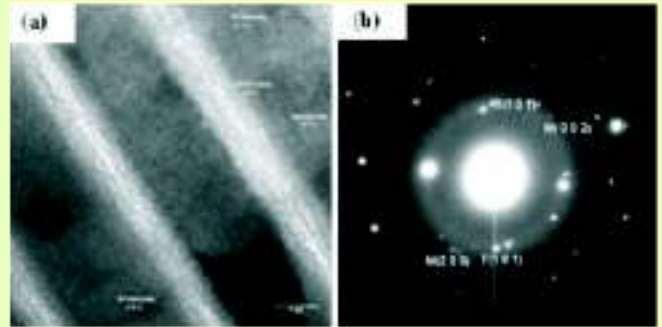

*Lattice image from the  $Al_2O_3/ZrO_2$  multilayers and selected area diffraction pattern from a region of (a) (IGCAR)*

Various superconducting materials were studied for a better basic understanding of their properties, and for possible exploitation for superconducting RF cavity applications.

The indigenously developed nitride Metal Organic Vapour Phase Epitaxy (MOVPE) system was commissioned and epitaxial GaN layers were deposited on Sapphire substrates.

An automatic diameter control pull head was developed which can be controlled by a local or remote PC through network. This pull head was successfully used to grow crystals having melting point upto  $1300^\circ C$ .

At IGCAR, nano-scale multi-layers of  $Al_2O_3/ZrO_2$  were developed by reactive pulsed laser deposition at different zirconia layer thicknesses to study the effect of zirconia layer thickness on the stabilization of tetragonal  $ZrO_2$  phase, while keeping the alumina layer thickness (5 nm) constant.

Using tethered balloon and the conventional cellular system, its use for rural wireless telephone having an economy index of 30:1, was demonstrated by TIFR researchers.

## Cancer Research and Treatment

During the year of report, at the Tata Memorial Hospital, over 30,000 cases were registered for treatment of cancer and about 2450 new cases were registered in the preventive oncology.

# Executive Summary

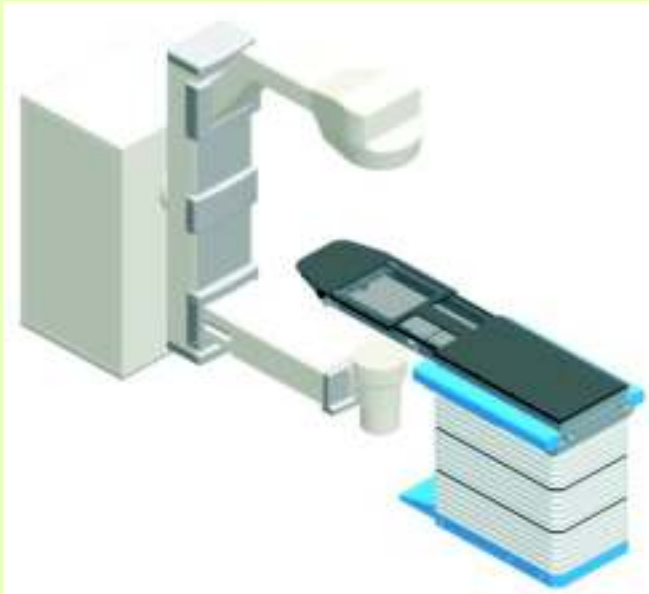

*Radiotherapy Simulator*

As part of cancer prevention programme, TMC provided cancer screening services for common cancers and created a model for cancer control programmes for the country. The TMC Mobile Screening Programme commenced and the Image Guided Radiotherapy Treatment (IGRT) facility was inaugurated.

As part of Societal Initiative, TMC continued its Urban Outreach Programme in Mumbai and the Rural Outreach Programme in the districts of Ratnagiri and Sindhudurg, of Maharashtra.

During the year of report, the Advanced Centre for Treatment, Research and Education in Cancer (ACTREC) initiated Neurosurgery Programme, and expanded the Programme in Radiation Oncology.

There was doubling of major cancer surgeries performed at ACTREC from 732 in 2008 to 1492 in 2009. The BMT (Bone Marrow Transplant), Neurosurgery and Tomotherapy research programmes were successfully consolidated. 36 BMTs were performed during 2009.

Several protocols/clinical research programmes were initiated or consolidated at the Clinical Research Centre (CRC).

At BARC, a Radiotherapy Simulator for

diagnosis and localization of cancer using diagnostic X-ray as the source of radiation, was developed.

## Synchrotrons & their Utilisation

Research activities carried out using Synchrotron Indus-1&2 at the Raja Ramanna Centre for Advanced Technology, continued during the report period.

Indus-2 and beamlines operated at different energies of 2.0, 2.4 and 2.5 GeV as per user requirements. The EDXRD and EXAFS beamlines were used by researchers.

Indus-1 operated regularly, providing 2358 hours of beam time for research work. The diagnostics beam line for measurement of vertical beam position stability in Indus-1 using synchrotron light, was commissioned. The research work relating to photo-triple-ionization of carbon dioxide molecule, fabrication of multilayers for soft x-ray polarizer and porosity study at buried interfaces gave important results.

Various upgradations and improvements carried out on the Indus accelerators led to their enhanced performance.



*Indus-2 Synchrotron Radiation Beam Line with shielding hutch*

# Executive Summary

## Fusion & Other Plasma Technologies

Research on various aspects of plasma science including basic plasma physics, magnetically confined hot plasmas and plasma technologies for industrial applications, was carried out at the Institute of Plasma Research.

The Institute operates a Tokamak Aditya, and is building a Steady State Superconducting Tokamak (SST-1). Tokamak is a device in which very hot plasma is confined in a doughnut-shaped vacuum vessel with the help of strong magnetic fields.

At IPR, the main transformer of Aditya was made operational. Alignment and Calibration for the Aditya-Thomson scattering system was over and it was ready for regular operation. The imaging diagnostics for Aditya was also made operational. RF power was introduced when the plasma was present in the Tokamak. RF power was radiated by the antenna and different diagnostics detected the signals produced due to plasma heating.

The Steady State Tokamak-1 (SST-1) refurbishment activities under 'SST-1 Mission' gained momentum at validating the engineering and technology issues towards the early realization of the SST-1 first plasma.

## Compact Nuclear Power Plant

An important milestone was crossed when INS Arihant was launched. This demonstrated indigenous capability in building compact nuclear power plant meeting exacting and difficult to realise specifications. Its land based version at Kalpakkam that was operational earlier, continued to perform well.

## INTERNATIONAL RESEARCH COLLABORATIONS

NPCIL contributed in enhancing safety & reliability of nuclear power plants globally through its active participants in World Association of Nuclear Operators (WANO), Candu Owners Group (COG), etc. programmes. NPCIL contributed in

WANO Peer reviews, Good practices programmes, performance indicators, technical exchange & training programme.

At RRCAT, an all solid state bouncer compensated modulator was developed for a CERN experiment. The modulator achieved rated specifications and was accepted by the CERN team. To qualify the development of subsystems, electronics and components for pulsed H-accelerators programme, a pulsed 1.3 MW 352.2 MHz test stand was built around a klystron obtained from CERN.

RRCAT fabricated two prototype 1.3 GHz single cell superconducting cavities in collaboration with the Inter University Accelerator Centre (IUAC), New Delhi and shipped to Fermi Lab, USA.

Under the INPRO programme, an international benchmark exercise was undertaken to evaluate the reliability of Passive Decay Heat Removal system (PDHR) of 2400 MW(thermal) French Gas cooled Fast Reactor. BARC is using its Assessment of Passive System Reliability (APSRA) methodology for evaluating the reliability of the PDHR.

Several physics and engineering experiments were carried out with international collaboration in the French PHENIX fast reactor before its permanent shut down, mainly for validating the data and computer codes used for reactor design and operation.

## ITER-India

During the report period, two Procurement Arrangements were signed and pre-procurement activities for the remaining International Thermonuclear Experimental Reactor (ITER) packages continued towards signing the Procurement Arrangements.

For various design, development and analysis work, Memoranda of Understanding (MoUs) with Electronics Corporation of India Ltd., Nuclear Power Corporation of India Ltd. and Engineers India Ltd. were signed.

Activities related to neutron transport had started. Detailed design, and analysis for various



# Executive Summary

equipment and systems continued.

For the remaining procurement packages, interaction with potential equipment suppliers continued and Expression of Interest for some of the procurement started.

## OTHER ACTIVITIES

### Research Education Linkage

DAE supports synergistic interaction amongst the national laboratories and the university systems through a number of mechanisms such as grants-in-aid to institutes of national eminence, funding of extra-mural research, DAE-UGC Consortium for Scientific Research, and others.

During the report period, BARC signed a number of MoUs with various institutes and universities. Some are listed below :

**IIT-Delhi** : BRNS sponsored research project on 'Programme in Autonomous Robotics'. The project encompasses vision guided control of a robot manipulator, immersive environment of teleoperation and adaptive control & teleoperation of an industrial robot.

**Jadavpur University**: Development of cyclic plasticity models, studies on large-scale molten material-coolant interaction, clad behaviour under accident condition and thermal-hydraulics of PHWR channel blowdown and code development for numerical simulation of premixing phase of fuel-coolant interaction in Indian PHWRs.

**IIT-Roorkee** : Studies on experimental investigation of asymmetric heating of pressure tubes, experimental investigation of rewetting of fuel rod cluster, Debris bed heat up for PHWR, and experimental investigation of full length pressure tube sagging and ballooning under LOCA with loss of ECCS condition.

**IIT-Kharagpur** : Development of generalized procedure for determination of partial safety factors for containment design for all load cases considering uncertainties in material properties and load calculation.

**IIT-Guwahati** : Pressure tube creep correlation development.

**Vadodara University** : Study on vapour pull through for scale down model of PHWR.

**Guru Jambheshwar University of Science and Technology** : Developing it as a Centre for radioecology in view of proposed nuclear power plant at Hissar, Haryana.

### Human Resource Development

Homi Bhabha National Institute (HBNI) continued to strive for excellence in the academic programmes in DAE. Regular academic programmes at its 10 constituent Institutions were conducted.

BARC continued selection of candidates for the Orientation Course for Engineering Graduates & Science Post-Graduates (OCES) and DAE Graduate Fellowship Scheme (DGFS). The Centre also facilitated practical training and project work of students from various streams of science and technology from institutes and universities. Over 1100 students from Indian universities and institutes were benefited from this support.

The BARC Training School relocated its activities to the New Training School Complex at Anushakti Nagar.

Induction training in operational radiation protection, for scientific assistants, continued. The One-year post M.Sc. Diploma in Radiological Physics course under the aegis of Homi Bhabha National Institute (Deemed University) continued to meet the mandatory trained manpower requirement of radiation safety professionals in medical, industrial, research and agricultural applications of radiation.

A Standing Training Committee constituted during 2009 provided impetus to training and skill development of NPCIL personnel at various levels. Training programmes like "Engineering deliverables for NPP", 'Honing the Managerial Skills', 'International Negotiating Skills', 'Human Resource Management for Line Managers' and

# Executive Summary

"Construction Engineers" were implemented as ongoing programmes. During the year about 10,000 person-days of training on above modules to SO/D to SO/G level officials was imparted.

This year, BARC Training school at Hyderabad was upgraded to ISO 9001:2008.

At IGCAR, the third batch of forty-five trainee scientific officers, which included new discipline material science, successfully completed their training. During this year, 50 officers were undergoing training at the Training School. Thirty-three Research Scholars were inducted to pursue their doctoral programmes in the frontier areas of engineering and basic sciences under the aegis of HBNI.

AMD nominated its employees for various technical and managerial courses/ workshops/ conferences conducted by various scientific and management institutes and universities.

## SPONSORED RESEARCH

### Promotion of Extra-mural Research in Nuclear Science

The Board of Research in Nuclear Science (BRNS) is an advisory body of DAE. Besides funding research projects and academic programmes, BRNS provides financial assistance to organise symposia / conferences / workshops on topics of relevance to the programmes of DAE.

This year, 134 new research projects were sanctioned by BRNS for financial support. The Board also awarded projects to young scientists to initiate them in a career of research, and Dr. K. S. Krishnan Research Associateship to identify and encourage talented young scientists and technologists to join research centres of DAE. The DAE Graduate Fellowship Scheme (DGFS) inducted graduate level students doing M.Tech. at the IITs, and fellowships were offered/awarded under the Raja Ramanna Fellowship Scheme to senior scientists.

Under the XI Plan activities, projects of the

Prospective Research Funding Scheme are also being awarded under BRNS. Currently, 10 projects are in progress.

During the Golden Jubilee Year, the Science Research Council (SRC) of DAE launched a unique programme to encourage exceptionally innovative research and development activities named as DAE-SRC Outstanding Research Investigator Award.

### Promotion of Mathematics

The National Board for Higher Mathematics (NBHM), with its mandate of promoting excellence in higher mathematics education and research in the country, continued to provide scholarships to talented students for pursuing studies at Masters and Ph.D. levels. At the undergraduate level a special programme "Mathematics Training and Talent Search" continued. Supplementary training activities were also undertaken for selected students at postgraduate level under the Advanced Training in Mathematics (ATM) programme.

NBHM organized Mathematics Olympiad activity for talented young students at higher secondary (the plus two) level. This activity is conducted with the help of the Homi Bhabha Centre for Science Education (HBCSE). To generate interest in mathematics in early years of college, a new competition 'Madhava Mathematical Competition' was also started this year at the undergraduate level, in Pune and Mumbai.

NBHM supported various special mathematical centres in the country, by way of funding of their activities. These included the Chennai Mathematical Institute, Institute of Mathematics, Bhubaneswar, Kerala School of Mathematics, Calicut, and Bhaskaracharya Pratishthana, Pune. The Board also provided grants for promotion of activities in pure and applied mathematics, under several schemes, including support to research projects, travel grants for participation in workshops, conferences, and undertaking collaborative research etc.

At the initiative of NBHM the International

# Executive Summary

Congress of Mathematicians (ICM-2010) will be held at the Hyderabad International Convention Centre, during August 19-27, 2010.

## GRANT-IN-AID

### Aided Institutions

DAE extends grants-in-aid to eight research institutions, and an Education Society (AEES). The funds (Plan & Non-Plan) allocated to these Aided Institutions during the fiscal 2009-10, are as under:

Sl. No.	Name of the Institutions	Budget Provision BE 2009 – 10 (Rs. in crore)
1.	Tata Institute of Fundamental Research	335.00
2.	Tata Memorial Centre	202.60
3.	Saha Institute of Nuclear Physics	111.16
4.	Institute of Physics	27.39
5.	Institute of Mathematical Sciences	21.57
6.	Harish-Chandra Research Institute	25.50
7.	Institute for Plasma Research	288.29
8.	National Institute of Science Education and Research (NISER)	32.00
9.	Atomic Energy Education Society	47.72

### Grants to Cancer Hospitals

DAE has signed the Third Tripartite Agreement with the North-Eastern Council and the Government of Assam, for the revitalization of the Dr. B. Barooah Cancer Institute (BBCI), Guwahati. This hospital is a Regional Cancer Centre (RCC) for cancer treatment and control in the North-Eastern Region. The Department's total share as per the Tripartite agreement is approximately Rs.10.45 crore, for revitalization of the BBCI.

The Department also extends financial assistance to cancer hospitals located in other parts of the country. The budget provision for such partial financial assistance for the current fiscal is to

the tune of Rs.20 crore.

For creating a better network between the Tata Memorial Hospital and the cancer institutions all over the country, an Apex Committee was formed under the chairmanship of Director, TMC. The Apex Committee deliberated on indigenous development and manufacturing of the equipment related to radiation oncology such as Cobalt-60 Teletherapy Machine, Low Energy Linear Accelerator, High Energy Linear Accelerator, Brachytherapy, etc. The initiatives taken will lead to further gains in the DAE's outreach in the cancer care programme.

In May 2008, the DAE has signed an MoU with the Health & Family Welfare Department of the Government of Meghalaya, for establishment of "DAE-Civil Hospital Cancer Wing" at Civil Hospital, Shillong. For this purpose, DAE sanctioned an amount of Rs.26.00 crore.

### Olympiad Programme

The International Olympiads in mathematics, physics, chemistry and biology are annual academic competitions to stimulate and challenge bright young pre-college students to excel in their subjects.

The Indian Science Olympiad Programme supported by DAE, Department of Science and Technology and Ministry of Human Resources Development has been doing well consistently.

DAE provides financial support for organizing Olympiad programmes and for participation in International Olympiads in Physics, Chemistry, Biology Mathematics, Astronomy & Astrophysics, and Junior Science Olympiad.

During the calendar year 2009, the Indian student participants in these Olympiads bagged 33 medals (14 gold, 15 silver and 4 bronze) and received an Hon'ble mention.

### TECHNOLOGY TRANSFER

The spin-off technologies developed and demonstrated at BARC and transferred to the public domain for further commercial proliferation,

# Executive Summary

include back washable Spiral Ultrafiltration Technology for domestic and industrial water purification, Multichannel Accoustic Emission Analyser Technology, UF Membrane assisted process technology for arsenic removal from ground/surface water, Hand held Tele-ECG instrument, Image Analysis System etc..12 new MoU's were executed between BARC and other agencies for the development of technologies of mutual interest.

At IGCAR, the design and development of the two independent and diverse Safety Logic Systems were completed. The technology was transferred to ECIL for final production and qualification. IGCAR also transferred technology of Real Time computer based systems.

## SOCIETAL INITIATIVES

As an integral part of DAE's societal initiative, five more new AKRUTI nodes were set up at different states in the country, taking the total AKRUTI nodes to 15.

The BARC-Centre for Incubation of Technology (BARCIT) started functioning with the setting up of four Incubation Cells that include Electron Beam Welding Technology, Water technology, Food technology and Medical and Laboratory equipment development technology.

NPCIL continued its support to the community in and around nuclear power plants, in the sphere of health, education and basic infrastructure development.

IGCAR provided vocational training to 70 students from neighbourhood villages with vocational training in collaboration with professional bodies and government of Tamil Nadu and 50 with certification in four NDE methods. This increased the employability and also created trained technical manpower for the projects at Kalpakkam

## INTELLECTUAL PROPERTY RIGHTS

DAE-IPR Cell constituted by the Department,

works as a nodal agency for all IPR related matters including filing of patents within India and abroad for all the organizations under DAE's fold.

During the year 2009, DAE filed 18 patent applications including 4 in India, 5 under Patent Cooperation Treaty (PCT), 3 in USA, 2 in Canada, and 1 each in South Africa, Japan, Australia and France. During this period, 9 of the previously filed patents were granted to the Department.

So far, DAE has filed 219 applications including PCT and national phase applications. Of these, 121 patents have been granted. 64 patents are in force at present.

## PUBLIC SECTOR UNDERTAKINGS (Financial Performance)

DAE, under its aegis, has five public sector undertakings namely, the Nuclear Power Corporation of India Ltd., Bhartiya Nabhikiya Vidyut Nigam Ltd., Uranium Corporation of India Ltd., Indian Rare Earth Ltd. and Electronics Corporation of India Ltd. Financial performance of these undertakings (except BHAVINI which is yet to commence commercial operations) are given below.

### *Nuclear Power Corporation of India Ltd*

The provisional net profit (PAT) for the year 2009-10 (upto December 31, 2009) was Rs. 303 crore. The profit is lower in view of low generation on account of fuel supply continuing to be constrained during the year. NPCIL bonds continued to be rated at AAA (Highest Safety) by CRISIL and CARE.

### *Uranium Corporation of India Ltd*

During the year 2008-09, the turnover of UCIL increased up to Rs.397.29 crore as against Rs.303.12 crore in the previous year, posting a 31% rise. The net profit stood at Rs. 18.01 crore against Rs.14.63 crore in the previous year.

### *Indian Rare Earths Ltd.*

During the year 2008-09, IRE's Sales Turnover



# Executive Summary

was Rs.336.56 crore against Rs. 295.97 crore in 2007-08. It recorded Profit before tax at Rs.82.88 crore against Rs.228.76 crore in 2007-08, and earned foreign exchange of Rs. 48.19 crore.

IRE paid 20% dividend on the paid-up capital amounting to Rs.17.27 crore for both the financial year 2007-08 and 2008-09. For the year 2009-10, a sales turnover of Rs.300 crore is expected.

## Electronics Corporation of India Ltd

ECIL achieved a Production of Rs.577 crore and a Net Sales of Rs.523 crore upto December 2009 as compared to Rs.744 crore and Rs.679 crore respectively for the corresponding period during 2008-09. The Company is executing some long-term projects which are expected to come to a close in the next two months. In view of this it expects to achieve the sales and production targets of Rs.1239 crore each.

## NATIONAL SECURITY

BARC continued implementation of the necessary research and development as well as manufacturing activities required for national security.

## CRISIS MANAGEMENT

The Crisis Management Group (CMG) is a standing Committee of senior officials of DAE responsible for coordinating the Department's response to a radiation emergency in the public domain. A response system is in place to tackle such situations, by mobilizing the expertise of DAE in the field of radiation measurement and protection and medical treatment of radiation injuries.

To ensure that the emergency plans are in high state of readiness, major nuclear facilities like nuclear power stations and hydrogen sulphide based heavy water plants periodically carry out a variety of emergency exercises.

During the year 2009, the following exercises were carried out:

1.	Communication Exercises	-	285
2.	Fire Emergency Exercises	-	79
3.	Plant Emergency Exercises	-	39
4.	Site Emergency Exercises	-	10
5.	Off-Site Emergency Exercises-		5

The Off-Site Emergency Exercises were conducted in the public domain in the vicinity of nuclear power stations at Tarapur in Maharashtra, Rawatbhatta in Rajasthan, Kalpakkam in Tamil Nadu, Kaiga in Karnataka and of the heavy water plant at Manuguru, Andhra Pradesh. These Off Site Exercises were conducted by the concerned district officials (the District Magistrate or Collector is the Off Site Emergency Director) and information flows were established to the CMG as well as to the National Crisis Management Committee of the Union Government. The external observers for these exercises included among others, senior officials from the National Disaster Management Authority (NDMA) and the Cabinet Secretariat.

The same system is also available to respond to a request from any public official in the event of the reported presence or suspected presence of radioactive material. For this purpose, guidelines were circulated to all the State Governments and Union Territories.

A significant component of the emergency response system of DAE is the availability of two emergency communications rooms at Mumbai, which continued to work round the clock throughout the year. These have multiple modes of communication and are in constant contact with various nuclear facilities in the country as well as with the International Atomic Energy Agency (IAEA) in Vienna.

The CMG also provided its expertise in various forums in the field of disaster management at both National and International levels.

## BARC SAFETY COUNCIL

BARC- Safety Council continued its regulatory function to ensure the safety of all the plants and facilities under its purview.



# Executive Summary

## SCIENCE RESEARCH COUNCIL

DAE-Science Research Council, consisting of eminent scientists, continued with the peer reviews of basic research to ensure that highest possible level of excellence is maintained.

## INTERNATIONAL RELATIONS

India has been designated member of the Board of Governors of the International Atomic Energy Agency (IAEA) since its inception and has been taking active part in policy management and programmes of the Agency.

India continued to offer training facilities, fellowships, scientific visits, etc. to foreign scientists and provided services of its scientists for expert assignments to other countries both through IAEA and through the bilateral agreements for co-operation in the field of peaceful uses of atomic energy.

Some notable bilateral agreements during the year 2009-10 were as follows:

- Agreement between the India and the Government of Republic of Namibia on cooperation in Peaceful Uses of Nuclear Energy.
- Memorandum of Understanding between India and the Nuclear Energy Agency, Regulatory Agency of the Government of Mongolia, on cooperation, in the field of Peaceful Use of Radioactive Minerals and Nuclear Energy.
- Agreement for cooperation between India and the European Atomic Energy Community in the field of Fusion Energy Research.
- A joint declaration by India and the United Kingdom on Civil Nuclear Cooperation.

## VIGILANCE

The overall responsibility of vigilance activities rests with the Chief Vigilance Officer of DAE. To facilitate proper functioning of the vigilance machinery and to establish effective co-ordination amongst the organizations, a senior officer in each organisation of DAE was designated as Vigilance

Officer. In the DAE's public sector undertakings, full time Chief Vigilance Officers coordinated the vigilance activities.

Vigilance functions included timely transmission of various vigilance returns to the Central Bureau of Investigation (CBI), Department of Personnel and Training (DP&T)/Central Vigilance Commission (CVC), issuance of prosecution sanctions, processing of vigilance & disciplinary cases, monitoring of the progress of inquiry proceedings, investigation of complaints and others.

An Annual Action Plan was worked out by all DAE units. As advised by CVC, two specific areas prone to corruption (i.e. tendering, disposal of scrap material, recruitment of personnel etc.) were identified by each Unit for concerted action.

Auditing of the transactions of the Department was carried out regularly by concerned agencies.

## PUBLIC AWARENESS

During the report period, DAE and its organisations continued their efforts towards creating mass awareness about the various programmes of the department and their societal impact. They organised and participated in a number of exhibitions, seminars, workshops and essays and quiz contests. Programmes were also organised in connection with the Birth Centenary of Dr. Homi Jehangir Bhabha.

An International Conference on Peaceful Uses of Atomic Energy was held in collaboration with the International Atomic Energy Agency and Indian Nuclear Society, in New Delhi. A Bhabha Centenary Symposium on "Science and Technology at the Frontiers" was organised in Mumbai, jointly by TIFR and DAE.

In the 'S&T Expo - Pride of India' organised in Thiruvanthapuram in parallel to the 97th session of Indian Science Congress during January 3-7, 2010, DAE put up a pavilion, displaying its entire spectrum of activities. During October, 2009, the 21st DAE-All India Essay Contest on Nuclear

# Executive Summary

Science & Technology was held for undergraduate students. In collaboration with ISRO and the Confederation of Indian Farmers Association, the Department held a series of 8 seminars for farmers, agriculturists and general public, at different places in the country.

DAE also provided financial assistance for organising various scientific awareness programmes.

National Technology Day was celebrated at Trombay on 11th May 2009. Hundredth Birth Anniversary of Dr. Homi Bhabha was celebrated on 30th October, 2009 (Founder's Day).

As a part of Dr. Bhabha's birth centenary year, a programme on Atomic Energy in National Development was organized in collaboration with Dayanand Science College, Latur, on May 23-24, 2009.

Various national & international symposia, Trombay colloquium and theme workshops were organized during this year. BARC Officer's Association (BARCOA) with BRNS, held a symposium on "BARC Technologies for Development of Rural India".

As a part of Awareness-Visit, students and faculty members from colleges all over the country, and defence personnel visited BARC.

Five public awareness programmes at various educational institutions on Nuclear Energy for National Development was organized.

NPCIL's website ([www.npcil.nic.in](http://www.npcil.nic.in)) continued providing updated information about the company. Publication of Nu-Power an international quarterly journal continued. Efforts of setting up of a permanent exhibition on 'Hall of Nuclear Power' at

Nehru Science Centre, Mumbai" continued.

Multimedia presentations / films were produced to disseminate authentic information about NPCIL and nuclear power. News article repository system, a source of information of news articles on nuclear power, for every employee of the company, was maintained.

NPCIL participated in 8 exhibitions including 4 international exhibitions.

As a part of student awareness/contact programme in colleges and schools, AMD organized lecture series, video shows, and exhibition on the exploration activities, question and answer sessions with students and faculty members.

## AWARDS & HONOURS

During the report period, DAE's organizations bagged a number of awards for safety and environment management. These included :

- Safety awards received by the operating stations of NPCIL included awards from the National Safety Council of India (NSCI); National Safety Council (Maharashtra Chapter); DGFASLI, Karnataka Chapter Safety Council, Bangalore and National Safety Council, Mumbai.
- HWP, Manuguru received Prashansa Patra Award-2008 by the National Safety Council, and the AERB Industrial Safety Award-2008. Heavy Water Plant, Kota was given Suraksha Puraskar-2008 by the National Safety Council of India and "ICC Award-2009 for Water Resource Management In Chemical Industry".

# Chapter : 1

## Nuclear Power Programme : Stage-I



*Rajasthan Atomic Power Project-5&6 Main Plant View*

# Nuclear Power Programme: Stage I

## NUCLEAR POWER PROGRAMME-I

The Nuclear Power Corporation of India Ltd. (NPCIL) commissioned its 18th reactor when it synchronized RAPP-5 with the grid on December 22, 2009 raising installed Nuclear Power Capacity to 4340 MW. In addition, the Company is also engaged in construction of four nuclear power reactors (2 PHWRs and 2 Light Water Reactors), at three project sites, totaling 2440 MWe capacity.

### Nuclear Power Generation

Generation of electricity from nuclear power plants was 17016 million units (MUs) during the calendar year 2009. The generation for the financial year 2009-10 (upto December 31, 2009) was 13543 MUs. The generation during the year improved compared to previous year in view of imported fuel availability consequent to fruition of international co-operation. However, the generation achieved was lower than target in view of domestic fuel supply remaining constrained.

The electricity generation since commencement of commercial operation of NPCIL units till end of December, 2009 was 3,06,139 MUs. The stationwise generation since commercial operation, during the calendar year 2009 and the financial year 2009-10 (till December 2009) is indicated as follows:

STATION	CAPACITY (MW)	GENERATION IN MUs		
		Since Commercial operation to Dec-09	Calendar Year 2009	Financial Year 2009-10 (upto Dec-09)
TAPS	1400	97374	7644	5940
RAPS	640	54536	2900	2283
MAPS	440	47597	1892	1516
NAPS	440	39634	685	554
KAPS	440	39775	929	797
KGS	660	27222	2967	2453

*The generation from RAPS-1 since commercial operation was 11,826 MUs.*

### High Availability Factors and Continuous Operation of Units

RAPS-4 recorded 394 days continuous run on June 15, 2009 (May 17, 2008 to June 15, 2009). Earlier to this, RAPS-4 also had a record of continuous run was of 373 days. Kaiga Generating Station Unit-1&2, and Kakrapar Atomic Power Station Unit-1 had a record of continuous run of more than a year.

For the financial year 2009-10 (upto December 31, 2009) the overall weighted average

availability factor for the operating stations was 91%. The unitwise availability factors during the calendar year 2009 are depicted below:

### Projects Under Construction

#### KAIGA-3&4 (2x220 MW PHWRs)

Kaiga Atomic Power Project-3&4, located adjacent to the Kaiga Generating Station-1&2 at Kaiga in Uttar Kannada District, Karwar

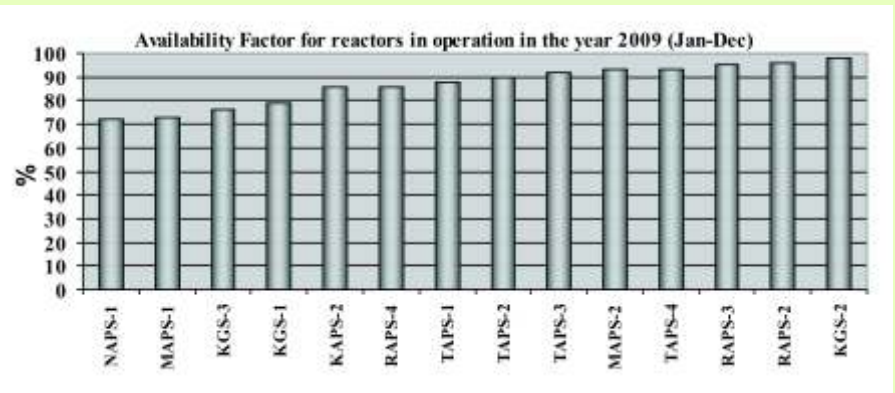

*Note :RAPS - which was under shutdown for EMFR works since July 2, 2007, was re-synchronised to grid on September 1, 2009. NAPS-2 and KAPS-1 under shutdown since December 18, 2007 and July 1, 2008 respectively for EMCCR and upgradation works. The work on NAPS-2 is completed and the unit is awaiting fuel supply for startup. KAPS-1 is scheduled to be completed in 2010-11.*



# Nuclear Power Programme: Stage I



*Kaiga-3&4 Main Plant from North-East*



*RAPP-5&6 Main Plant View*

Karnataka state, was sanctioned in May, 2001. The construction activities of the project were commenced with the start of first pour of the concrete on March 30, 2002, the zero date of the project. Kaiga-3 was completed and declared commercial in May, 2007. Construction works on Kaiga-4 were completed and the unit start up is linked to fuel supply.

## **RAPP-5&6** **(2x220 MW PHWRs)**

The project is located adjacent to the existing operating units RAPS-1&2 and RAPS-3&4, along the bank of the Chambal river at Rawatbhata in Rajasthan. RAPP-5 attained first criticality on November 24, 2009. The unit was synchronised to the grid on December 22, 2009, after 28 days of attaining criticality. Fuel loading in RAPP-6 is completed and the unit is expected to achieve criticality by end January, 2010.

## **KKNPP-1&2** **(2x1000 MW LWRs)**

The Kudankulam Nuclear Power Project, located in Tirunelveli district of Tamilnadu, is being implemented with technical co-operation with Russian Federation within the framework of the Inter-

Governmental Agreement (IGA) signed between USSR and India. The power generated from the project (2x1000 MW) will be fed to Tamilnadu State and other beneficiary states in the southern grid. The project has recorded a cumulative physical progress of 90.8% up to the December, 2009



*Kudankulam Nuclear Power Project - 1&2*

# Nuclear Power Programme: Stage I

(Unit-1: 94.2% and Unit-2: 85.4%).

**KK Unit-1:** Turbine was boxed up. Common Services Systems including Desalination Plant and DM Water Plant and switchyard were commissioned. The pre-commissioning of balance services systems and reactor auxiliary systems was commenced.

**KK Unit-2:** Construction and erection works are progressing with a time gap of about 6 months with reference to Unit-1. Construction of inner containment and outer containment dome was completed. Concreting of Primary Heat Removal System (PHRS) dome was in advance stage of construction.

## **EMFR, Coolant Channel Replacement and Upgradation Works**

**RAPS-2:** RAPS-2, which is under IAEA safeguards, was fuelled with imported fuel and it was re-synchronised to the grid on September 1, 2009 after completion of Enmasse Feeders Replacement (EMFR). Since its synchronization, the unit operated at 88% capacity factor and 96% availability factor (till end December, 2009).

**NAPS-2:** The unit is under planned shutdown, since December 18, 2007 for EMCCR and upgradation works. These works are completed and the unit start up is linked to fuel supply.



*Enmasse Coolant Channel Replacement activities at KAPS-1*

**KAPS-1:** The unit is under planned shutdown since July 1, 2008 for EMCCR and upgradation works. Pressure tubs installation was completed. Calandria vault liners leaks identification and rectification from north fuelling machine vault was completed. Feeders erection was nearing completion.

## **New Projects**

### **Pressurised Heavy Water Reactors**

Consequent to administrative and financial approval by the Government in October, 2009 project works on Kakrapar Atomic Power Project-3&4 (KAPP-3&4, 2x700 MW

PHWRs) and Rajasthan Atomic Power Project-7&8 (RAPP-7&8, 2x700 MW PHWRs) were started.

### **KAPP-3&4**

- First pour of concrete is scheduled in June, 2010.
- Sitting and Excavation consents from AERB were obtained.
- Work Order was awarded for main plant civil works.
- Manufacturing of Steam generators for both the units was in full swing.

### **RAPP-7&8**

- First pour of concrete is scheduled in December, 2010.
- Environmental clearance

# Nuclear Power Programme: Stage I

accorded by Ministry of Environment & Forests.

- Purchase Order for Steam Generators is placed for both units.
- Finalization of packages and tendering action for the procurement of other critical equipment is in various stages.

## Light Water Reactors

Pre-project activities like statutory clearances, land acquisition related activities, etc. on Kudankulam Nuclear Power Project (KKNPP-3&4, 2x1000 MW LWRs) and Jaitapur Nuclear Power Projects (JNPP-1&2, 2x1650 MW LWRs) were in advanced stages.

**KKNPP-3&4:** The site has “in principle” approval of the Government for 6x1000 MW LWRs. An Inter-Governmental Agreement (IGA) between India and Russian Federation on construction of additional nuclear power plants at Kudankulam site was signed in December, 2008. Environmental clearance for the project was accorded in September, 2008 from MOEF. Application of sitting consent is under review by AERB. Phase-A Pre-project activities have commenced. All geo-technical examinations and statutory clearance except AERB consent were obtained. Techno-commercial offer from Russian federation were received and discussions were in progress.

**JNPP-1&2:** Earlier “in-principle” approval was accorded by the Govt. for setting up 2X1000 MW LWRs type NPP units at Jaitapur Site in October, 2005 which has now been extended in October, 2009 for setting up of a capacity 6x1650 MW NPP at this site. MoU was signed between NPCIL and AREVA on February 4, 2009. AREVA had submitted Techno-Commercial offer on July 9-10, 2009 for setting up first stage 2x 1650 MW EPRs. Same is under review. The process of MoEF clearance was in progress. “No objection certificate” from Maharashtra Coastal Zone Management Authority was obtained. All awards for land acquisition were approved by state authorities and further works on land acquisition was in advance stages.

## 'In-Principle' Approval of Sites

Government accorded 'in principle' approval for five green field sites including two inland sites and three coastal sites for

setting up of PHWRs and LWRs respectively. Sanction for capacity expansion at Kudankulam and Jaitapur sites were also accorded.

## Engineering Activities - 700 MW PHWRs

The engineering of the 700MW PHWR plant were carried out using state-of-the-art technology for the first time in NPCIL. 3-D model of the plant is under advance stage of development to address various issues at design stage itself. Emphasis is being given on evolving a construction friendly design, modular construction in critical areas, proper package formulation, minimization of rework at site, timely availability of equipment and construction material. The breaking down of design, procurement and construction activities are ensured to be to the lowest possible level so as to achieve close integrated progress monitoring which would help in compressing the overall project schedule.

“In-principle” approved sites

Site	Capacity (MW)	Remarks
Kumharia, Haryana	4x700 , PHWRs	Pre-project activities initiated
Bargi, Madhya Pradesh	2x700, PHWRs	Pre-project activities initiated
Kudankulam, Tamilnadu	6x1000, LWRs	KK 1&2 under construction
Jaitapur, Maharashtra	6x1650, LWRs	Land acquisition in progress
Haripur, West Bengal	6x1000, LWRs	The exact capacity of the sites would depend on the number and type of reactors set up at each site
Mithi Virdi, Gujarat	6x1000, LWRs	
Kovvada, Andhra Pradesh	6x1000, LWRs	



# Nuclear Power Programme: Stage I

## **Partnership and Diversification**

NPCIL has planned to augment nuclear power generation in a rapid manner and also to promote, other than nuclear sources, clean sources of energy as far as possible through partnerships and diversification. To meet the Nuclear Power expansion plans, NPCIL signed a Memorandum of Understandings (MoU) with NTPC, L&T, IOCL, NALCO, Korea Electric Power Corporation (KEPCO), etc. to work together for setting up Nuclear Power Plants in India. The MoU with L&T is for a Joint Venture Company (JVC) to manufacture special exotic steels ingots and ultra heavy forgings. Indigenous manufacture of forgings will close a critical gap in Indian industry's capability to produce equipment for nuclear, thermal power and hydrocarbon plants. The MoU with NTPC Limited is to incorporate a Joint Venture Company to work together for setting up Nuclear Power Plants in India.

As per MoU between NPCIL and Tehri Hydroelectric Development Corporation Limited (THDC), the work for preparation of Detailed Project

Report (DPR) for Malshej Ghat (600 MW) hydroelectric project has started. NPCIL set up a 10 MW Wind Farm at Kudankulam in Tamil Nadu which is in successful operation since January 19, 2007. NPCIL is considering installation of additional 10 MW wind power in 2010-11.

## **FRONT-END FUEL CYCLE**

### **Heavy Water Production**

Heavy Water Board has contributed successfully to the first stage of Nuclear Power Programme by supplying Heavy Water to all Pressurized Heavy Water Reactors (PHWRs) in a cost effective manner. Over a period of time, while emerging as the largest global producer of this strategic material, HWB has developed similar capabilities in various other areas, like specialty chemicals and other stable isotopes.

The performance of Heavy Water Board was continually improving over a period of time with respect to capacity utilization, specific energy consumption, productivity, safety

performance, environment management etc.

The capacity utilization during the financial year 2009-10 is expected to touch 108%. Comparison of the plant performance with reference to the previous year is given below.

HWB has diversified into production of solvents required for DAE. Organo-Phosphorous solvents like D2EHPA (Di Ethyl Hexyl Phosphoric Acid) and TBP (Tri Butyle Phosphate), required for the front and back end of the fuel cycle are being produced at Talcher facility and they are meeting the international quality standards. HWP(Tuticorin) has also taken up the challenging job of developing synthesizing routes as well as synthesizing various organo phosphorous solvents like Tri Iso Amyl phosphate(TIAP), Di Hexyl Octanamide (DHOA) & 2-ethyl hexyl-2-ethyl hexyl phosphonic acid(D2EHPA-II).

HWB has taken up development of Solvent Extraction Technology as well as process/ equipment development for recovery of Uranium from Wet Phosphoric Acid. Based on the know how obtained from the test facilities at HWP, Talcher, HWB is setting up Technology Demonstration Plant at the fertilizer plant of RCF, Trombay for recovery and production of Uranium from wet phosphoric acid. The facility was mechanically completed and pre-commissioning activities were in progress..

The VSPP (Versatile Solvent

Performance Indicators	2009-10 (April to Dec.)	2008-09 (April to Dec.)	2009-10 (Expected)	2008-09
% Target achieved	113	105.7	108	111.7
Specific Energy consumption (GJ/Kg)	29.62	28.8	31.5*	28.8

\* inclusive of energy consumption at the Technology Demonstration Plant at HWP, Baroda



## Nuclear Power Programme: Stage I

Production Plant) was set up at HWP, Talcher, for production of various types of Organo phosphorous solvents, namely D2EHPA, TOPO, TAPO or DNPPA in different batches, as per demand prevailing from time to time. The plant was mechanically completed and pre-commissioning was in progress.

Second stage of India's nuclear power programme requires Boron enriched in the isotope  $^{10}\text{B}$  at different levels of isotopic purity for applications in control rod, safety rod and neutron detectors. Country's first industrial scale production facility for Enriched Boron based on exchange distillation was commissioned at Talcher and the facility based on Ion exchange chromatography was commissioned at Manuguru. A plant for converting the enriched  $\text{KBF}_4$  into elemental

Boron based on the process of Electrolysis was set up at HWP, Manuguru.

$^{18}\text{O}$  is one of the isotopes having application in nuclear medicine and biochemical research. HWB has embarked on distillation route for production of  $\text{H}_2^{18}\text{O}$  at 99.8% purity, and engineering is in progress. At HWP, Tuticorin,  $^{18}\text{O}$  enrichment glassware facility was installed and test runs were conducted. Further tests using nuclear grade heavy water are being lined up.

In order to achieve reduction in internal dose to occupational workers of nuclear power plants, a Technology Demonstration Plant for Heavy Water clean up (HEWAC) is being set up at HWP, Kota based on design & engineering developed by HWB. Mechanical completion of the

facility was achieved and pre-commissioning activities made progress. Development of methodology for storage and associated issues was taken up.

Design, engineering and setting up of facility (Centralised Uranium Conversion facility) to convert Uranyl nitrate solution from reprocessing plants into depleted uranium oxide powder as final product was taken up by HWB.

During the current financial year, HWB bagged the sixteenth export order of 11 MT to M/s KHNP, South Korea.

Realizing the large potential for non-nuclear applications of deuterium in the fields of medicine, life science, communication and microelectronics, HWB initiated development of alternate applications of deuterium/heavy water both in life science as well as technological fields. Supply of 3%  $\text{D}_2\text{-N}_2$  gas mixture continued from HWP, Baroda, to a leading optical fibre cable manufacturer. At HWP, Baroda, laboratory scale production of inorganic deuterium compounds was established. Development of methods for production of organic deuterium compounds were also in progress at the plant.

Memorandum of Understanding between Heavy Water Board, Mumbai and Board of Radiation and Isotope Technology (BRIT) Mumbai was signed for development of alternate applications of heavy water and deuterium including



*Elemental Boron Plant at Heavy Water Plant, Manuguru, inaugurated by Dr. Anil Kakodkar, the then Chairman, AEC*

# Nuclear Power Programme: Stage I

deuterium labeled compounds and allied value added products.

## Plants' Performance

During the period April-December 2009, the Heavy Water Plant-Manuguru plant was operated with an excellent on-stream factor of 0.98. Production achieved was 139.6% of the rated capacity. As a result of implementation of various ENCON schemes and also due to stabilization of captive power plant, surplus power is getting generated and the same is exported to APTRANSCO. About 13.829 Million units of net power were exported during the period of report.

During the period, three XI plan capital schemes were implemented viz. Recovery of H<sub>2</sub>S from booster seal oil, standby 415 V feeder for coal unloading station and strengthening of ash pond. Retrofitting of TG-II AVR with latest microprocessor based DVR from M/s BHEL was completed and performance found to be satisfactory.

Utilisation of Fly Ash continued for making fly ash bricks, reclamation of low lying areas, making pavements in and around the plant site & colony and pond ash stowing in underground mines of M/s SCCL and pond ash application in agriculture.

Since October 2000 about 375833 MT of fly ash was filled in low lying areas and about 69469 MT of fly ash was utilized for brick making. About 23,400 MT



*Mist Cooling System Commissioned at Heavy Water Plant, Kota*

of fly ash was utilized in mine filling. 80 MT of fly ash was utilized as fertilizer in agriculture. In order to divert the collected fly ash to cement industries and reduce the load on storage sites in ash ponds, work Order was issued to M/s Indure Pvt. Ltd., New Delhi for installation of Dry ash collection system.

Heavy Water Plant, Kota achieved excellent performance during the period. Plant was under major turn around since 15th November 2009 to attend to mandatory maintenance and ISI jobs as well as to implement the challenging task of replacing old pneumatic instrumentation system to electronic Instrumentation for DCS at Control Room. The under ground fire water header was replaced with new over head pipeline and

new system hooked up.

To achieve Zero Effluent Discharge on a continuous basis, a standby effluent cooling system i.e. Mist Cooling System was commissioned this year. Mist Cooling System was in operation, giving satisfactory performance. This system has eliminated requirement of water for dilution of effluent and has resulted in less effluent generation and reduced the CESS charges by the state's pollution control board significantly.

Performance of Hazira Plant was excellent during the period in spite of the plant taking up a major turn around in April/May 2009. During MTA, Ammonia Converter Catalyst was replaced and activated. Heavy water Upgrading Column packing was also reactivated with ethanol &

## Nuclear Power Programme: Stage I

Sodium Hydroxide for the first time in DAE and the performance of the column was improved considerably with this effort. During the MTA, In-Service Inspection (ISI) on Ammonia Converter shell was conducted after a period of 20 years.

During the report period, the performance of the Heavy Water Plant, Thal was very good with lower energy consumption than the previous year in spite of interruptions in feed gas supply from ammonia plants of M/s. RCF. Annual turn around was carried out during April-May 2009, with all the scheduled activities completed satisfactorily. Implementation of a few energy saving schemes were carried out in scheduled time without any untoward incident in the plant.

HWP, Tuticorin is presently kept in preservation under nitrogen atmosphere due to non-availability of feed synthesis gas from the Ammonia Plant of M/s SPIC since April 2007. As per the directive of DAE, the available manpower of the plant was redeployed to other projects and a minimum number of plant personnel were engaged in establishing the various synthesis routes for organo phosphorous solvents, trial operations of various sizes of mixer-settlers and for operating a laboratory scale solvent extraction facility.

Revived Heavy water Plant, Baroda is operating for production of heavy water. Plant

was under MTA from end May to September 2009. Exhaustive maintenance jobs were carried out for the old hyper compressors 20K4, convertor ammonia cooler 13R2 and Cracker condensate pre-heater 16E1.

Major modification jobs were carried out during the shut down. Existing cooling tower pumps of single stage, horizontally split, negative suction centrifugal pumps were replaced by high efficiency multi stage vertical turbine pumps. Existing 10E1 heat exchanger which is a retrofit arrangement where a gas to gas liquid to liquid exchanger. The existing 10E1 was having inter stream leakage resulting in mixing of

feed and product. The new pair of shell and tube exchanger was taken in line and was giving required output.

The plant continued to receive 25% rebate in water cess, fourth consecutive year, from the Gujarat Pollution Control Board on effluent water as quality of effluent water meets GPCB requirement.

As a part of diversification activities, engineering work was already initiated for setting up of scaled-up Tri Butyl Phosphate production of 130MT/ year capacity plant at Baroda. Pre-commissioning of the TBP plant with water and organic fluid are expected to be completed by March, 2010.



*Solar Steam Generator System at Heavy Water Plant, Kota*



# Nuclear Power Programme: Stage I

## Energy conservation

During the report period, HWP, Manuguru implemented many energy saving schemes like Installation of Variable Frequency Drive in Condensate Extraction Pump of Unit-2 (40 MW saving); Installation of VFDs for the motors of 2CT transfer pumps, re-circ pump in XU-I, 2CT and CT1 re-circ pumps in XU-II (226 KW saving); Re-cycling of Guard pond water to Main Plant Cooling Tower Make up (saving in 65 M3/H of raw water and resultant reduction in cost of raw water treatment).

Solar energy is planned to be trapped for generation of steam through an alternative route. Setting up of a 400 kg/hr Solar Steam Generator System continued to generate steam at a pressure of 10.0 kg/sq cm for 10 hrs a day. Installation works for the four dishes have been completed and commissioning activities were in hand.

At HWP, Thal, the scheme of bifurcation of Cooling Water system into two pressure system (HP & LP) was implemented and hooked up with the cooling water pump & the piping system. This resulted in saving of 190 KW electrical power. Existing high pressure Globe & check valves were replaced with low differential pressure valves for reducing pressure drop in the plant. This increased feed gas throughput by 2 MT/hr per plant,



*Panoramic view of Mussorie Syncline where Khrol limestone has thrust over Tal Group. Black shale + Phosphorite along the thrust contact records uraniferous radioactivity near Sarkhet, Dehradun district, Uttarakhand.*

which is equivalent to around 4 MT/yr increase in production of heavy water. Installation of new heat exchanger in catalyst separation unit and installation of VFDs for boiler feed water pump & 14P5 pumps has also resulted in saving of electrical power. Replacement of leaky heat exchanger with duplex SS tube material has improved the cooling water quality & overall performance of the system

## Mineral Exploration

The Atomic Minerals Directorate for Exploration and Research (AMD) accelerated the pace of exploration activities during the field season 2008-09. The salient achievements during

the annual programme of work carried out by AMD are as follows:

## Uranium Investigations

### Uranium Resources

14,876.50 tonnes ( $U_3O_8$ ) of additional uranium resources were established which included, 12,489.86 tonnes  $U_3O_8$  at Tummalapalle and adjoining blocks, Kadapa district, 854.64 tonnes  $U_3O_8$  at Peddagattu, and 440 tonnes  $U_3O_8$  at Chitrial Nalgonda district, 293 tonnes at Koppunuru, Guntur district, Andhra Pradesh, 792 tonnes  $U_3O_8$  at Rohil, Sikar district, Rajasthan and 7 tonnes at Lostoin, West Khasi Hills district, Meghalaya.



# Nuclear Power Programme: Stage I

This addition of reserves enhanced the total resources of Tummalapalle (40,567 tonnes), Peddagattu (7,585 tonnes), Chitrial (6240 tonnes), Rohil (4512 tonnes), Koppunuru (2761 tonnes) and Lostoin (771 tonnes) uranium deposits.

The country's uranium resources have been updated to 1,40,296 tonnes of  $U_3O_8$ .

## Ground Radiometric Surveys

Reconnaissance (5149 sq km) and detailed (112.83 sq km) surveys helped in locating following promising uranium anomalies (new/extension) in the Proterozoic and Phanerozoic basins associated with:

(i) North Delhi Fold Belt, Rajasthan Phyllitic quartzite near Khoh, in Jhunjhunu and altered metabasics/dolomite near Maota Sikar district, brecciated phyllite in Khori and sheared carbonaceous phyllite near Nibhor, Alwar district;

(ii) Tertiary basin, Uttarakhand  
Black shales in Mussoorie syncline, Lesser Himalaya, Dehradun district;

(iii) Mahakoshal meta sediments, Madhya Pradesh, Ferruginous breccia zone at Kathas and Baharia areas, Sidhi district;

(iv) IOG Basin, Orissa  
QPC horizon near Mankarhachuan village, Angul district.  
(v) Lachhri, Rajasthan



*Modified borehole camera survey unit with CMOS image sensor*

## Drilling

1,56,791.50 (Departmental: 56,052.15m and Contract: 1,00,739.35m) drilling (reconnoitry, exploratory and evaluation) was carried out to establish (a) additional uranium resources in the known occurrences and (b) subsurface continuity of mineralisation in the new promising areas.

Significant mineralised intercepts/bands are identified in boreholes drilled at Tummalapalle and adjoining blocks (Kannampalle, Rachakuntapalle and Motunutalapalle), Kadapa district, Peddagattu, Chitrial, Nalgonda district and Koppunuru, Guntur district, Andhra Pradesh; Deshnur, Belgaum district and Gogi, Gulburga district,

Karnataka; Rohil, Sikar district, Rajasthan.

Potential/significant blocks were also identified in North Delhi Fold belt at Hurra Ki Dhani-Maota-Jahaz sector Sikar district, Rajasthan; Raghunathpura-Rambas-Gorir-Dhancholi sector, Mahendragarh district, Haryana; Nalpani, Durg district, and Dumhath, Surguja district, Chhattisgarh; extensions of Bangurdih radioactive occurrence, Seraikella-Kharswan district, Jharkhand, Beldih, Purulia district, West Bengal and Umthongkut, West Khasi Hills district, Meghalaya.

## Exploratory Mining

Exploratory mining was initiated on 18.06.2007 by UCIL

# Nuclear Power Programme: Stage I

on behalf of AMD and a progress of 122m in shaft sinking, 47m in cross cut and 11m in inset drive was achieved since commencement at Gogi, Gulburga district, Karnataka. Three Hundred (300) kg of ore handed over to the Mineral Processing Division, BARC, Hyderabad, Andhra Pradesh and 49.50 MT of ore was sent to Technology Demonstration Pilot Plant (TDPP), Jaduguda, Jharkhand for the preparation of flow sheet.

## **Geochemical Survey**

Geochemical surveys (1685 sq.km) were carried out in different parts of the country for delineating the target areas for detailed investigations. The important anomalous areas identified were:

Sikar district, Rajasthan: Hydro uranium values up to 44 ppb with an average of 10.82 ppb and gamma-ray logging of private tube wells spread over 4 km strike length along Kotri-Jahaz lineament (Hurra Ki Dhani-Maota-Jahaz sector) brought out anomalous sub-surface zones of probable uranium mineralization.

## **Geophysical investigations**

Regional magnetic, resistivity surveys (Departmental: 40 sq km and Outsourcing: 30 sq km), detailed gravity, magnetic, I.P / resistivity and EM surveys (27.58 sq km) carried out during this field season helped in deciphering:

- ◆ Prominent EM conductors (800m strike length and another 400m with a lateral shift) along the zone of

mineralization at Raghunathgarh, Sikar district, Rajasthan.

- ◆ Structurally disturbed low gravity and low resistivity zone coincides with low magnetic at Halbhavi-Muktapur sector, Gulburga district, Karnataka.
- ◆ Bipolar magnetic anomaly at Kulang - Amarsang - Pormawdar, West Khasi Hills district, Meghalaya.

Ground geophysical surveys were also outsourced in different parts of the country.

## **Airborne survey and Remote Sensing**

Heliborne Time Domain EM, magnetic and gamma ray spectrometric surveys were carried out over 36,012 line km in the north-east and central blocks of Bhima Basin.

## **Rare Metal and Rare Earth Investigations**

Reconnaissance (545 sq km) and detailed (4.13 sq km) surveys resulted in location of new occurrences of columbite-tantalite and Beryl bearing pegmatites in parts of Bastar district, Chhattisgarh.

2.880 tonnes of columbite-tantalite and 1.850 tonnes of beryl as by-product were produced at Pandikimal-Jangapara and Bodenar recovery units, Jharsuguda district, Orissa and Bodenar, Bastar district, Chhattisgarh respectively.



*Truck mounted Hydrostatic Rig*

# Nuclear Power Programme: Stage I

Additional reserves of 1.137 tonnes of columbite-tantalite were in pegmatite gravels of Sukopara, Bastar district, Chhattisgarh.

## **Beach Sand and Offshore Investigations**

Survey (Reconnaissance 264.37 sq km and 42.30 Line km, and detailed 10.02 sq.km) and exploration (drilling, sampling and evaluation) were continued along the coastal tracts of Orissa, Maharashtra, Andhra Pradesh, Tamilnadu and Kerala.

New potential heavy mineral zones were identified.

- Vodarevu-Peddaganjam coastal tract (3-50% TMH).
- Kunimedu-Pudupattinam coastal tract (up to 20% THM), Villupuram and Kanchipuram districts, Tamil Nadu and around Kolli Hills Complex (up to 80%, predominantly garnet) in paleo-lacustrine sediments.
- Paleo beach deposits around Baulpura and Bhitari Andhari tract, Jagatsinghpur district and Digipur & Kamalapur in red sediments, Ganjam district, Orissa.

A total of 58.88 MT of beach sand heavy mineral resources were estimated during XI Plan and the country's Total Heavy Mineral resources were updated to 942.58 MT. Detailed reports (8nos.) pertaining to different heavy

mineral sand deposits were completed.

## **Geotechnical investigations**

Geotechnical studies related to various upcoming nuclear facilities were carried out.

## **Laboratory Investigations**

The laboratories in the Regions and at AMD Headquarters rendered effective support to field investigations.

## **Research and Development**

Research and development activities were continued in different field areas to know the genesis, controls and understanding of uranium mineralization on regional as well as deposit scale.

Mathematical surface fitting for ground Total Magnetic Intensity (TMI), resistivity and chargeability data was carried out for Rohil area, Sikar district, Rajasthan. Other assignments on Chitral and Gogi were initiated.

Geostandards programme was re-initiated during the current field season and homogeneity test was carried out on 46 granite samples. Further work is under progress.

Multi elemental geochemical data compilation continued at AMD.

## **Time Domain Electromagnetic System**

The 200A & 16-metre diameter prototype Time Domain Electromagnetic System was

ground tested by IGCAR at Sonrai, UP and the data collected from the field experiments were processed and interpreted. The data correlate well with the borehole data received from the site.

## **Mining and Mineral Processing**

Uranium Corporation of India Limited (UCIL) produces uranium required for pressurized heavy water reactors. It is presently operating five underground mines (Jaduguda, Bhatin, Narwapahar, Turamdih & Bagjata), one open cast mine (Banduhurang), and two processing plants (Jaduguda and Turamdih) all in Jharkhand state.

With the increased demand of uranium for the country's nuclear power programme, UCIL took up Mohuldih Uranium Mining Project in the Saraikela-Kharsawan district of Jharkhand, Tummalapalle Uranium Mining & Milling Project in Andhra Pradesh and Exploratory Mining at Gogi in Karnataka.

Pre-project activities have started for Uranium ore mining and milling projects at Lambapur in Andhra Pradesh and Kylleng Pyndengsohiong, Mawthabah in Meghalaya.

## **Nuclear Fuel Fabrication**

Nuclear Fuel Complex is engaged in the production of natural uranium oxide fuel



# Nuclear Power Programme: Stage I



*Flagging off of 1st consignment of imported fuel for RAPS-2 by CMD, NPCIL*

bundles for PHWRs, enriched uranium fuel assemblies for BWRs, Reactor Core Structural, Reactivity Control Mechanisms and special materials like tantalum, niobium etc. In addition, for Fast Breeder Reactors, NFC produces all the core sub-assemblies and other critical components like fuel cladding tubes, Hexagonal wrapper tubes etc., made out of special stainless steels/D9

materials. Further, NFC also caters to the demand of high quality Stainless Steel tubes / pipes and titanium half alloy products for critical and strategic application in Nuclear Power, Defence and Space establishments.

Fuel requirement for RAPS-2, 5 & 6 was successfully met by fabrication of fuel from imported uranium.

With magnesium di-uranate (MDU) received from UCIL, 19-element & 37-element fuel bundles required for the reload fuel requirement of the operating PHWRs was met by reducing the conversion time from raw material receipt to manufacture of fuel bundles. 51 numbers of 19 element fuel bundles made of Slightly Enriched Uranium (SEU) were fabricated and dispatched for experimental irradiation studies. To augment the PHWR fuel fabrication capacity to 850 tpy, several high capacity equipment were procured and put into production line. Requisite numbers of BWR fuel bundles were manufactured and sent for reload requirement of TAPS-2.

A new appendage welding machine with improved design which can carry out welding of spacers and bearing pads on fuel tubes was manufactured and successfully introduced in the process line.

Consumption of TBP and nitric



*Zirconium Complex, Pazhayakayal*



*Indigenously fabricated Electron Beam Welding unit with imported gun and power supply*



# Nuclear Power Programme: Stage I

acid in Zirconium Oxide plant was brought down to the lowest ever figure. Recycling of Zirconium scrap like turnings was taken up to convert into valuable Reactor Grade Zirconium Sponge by commissioning additional water cooled scrap reactor and implementing innovative charging scheme in Argon atmosphere.

At Zirconium Complex, Pazhayakalay, Tamil Nadu, mechanical completion was over for utility systems, Oxide Production Facility and Sponge Production Facility. The Complex was inaugurated following the successful trial production of Zirconium Oxide.

Integration of imported electron beam welding gun along with indigenously fabricated CNC controlled welding chamber and other peripherals was completed and the system was successfully commissioned.

Experiments were carried at Special Materials Plant for heat treatment of Zr-2.5%Nb coolant tube for AHWR. Trial EB meltings were taken up in preparation of special alloys such as ZrNbAl for application as structural components of nuclear reactors & NbZr-C for high temperature applications under corrosive atmosphere. Tantalum ingot was supplied to Centre for Compositional Characterisation of Materials (CCCM) towards indigenisation of components for analytical instruments.

Commissioning of indigenously developed twin head HPTR 10-20 Pilgermill, which enhances the production of fuel tubes, and commissioning of Sponge Production Facility at Zirconium Complex, Pazhayakalay are expected to be achieved shortly.

## BACK-END FUEL CYCLE

### Fuel Reprocessing

All the three reprocessing plants at Trombay, Tarapur and Kalpakkam remained in operation to recover strategic material. At Kalpakkam, the KARP plant was recommissioned with improved features. Record chopping and processing of spent fuel bundles was achieved. Operation of PREFRE, Tarapur continued after completion of major maintenance jobs of shearing machine.

Operation of Plutonium Plant, Trombay continued for the recovery of strategic material. Fuels supplies to NFC, Hyderabad were augmented by processing of depleted uranium in the form of reject and scrap metal turnings.

Shifting of spent fuel continued from various NPCIL sites for storage in spent fuel storage facilities (SFSF) at Tarapur and Kalpakkam. Regulatory clearances were obtained for enhancing the storage capacity. Commissioning of ROP, Tarapur was taken up on priority to enhance reprocessing capacities. At the Power Reactor Thoria Reprocessing Facility, Trombay, the major equipments were installed. Approval from AERB was obtained for thoria fuel shipping cask. Various other projects such as WIP-3A, Kalpakkam, PREFRE-3A, AWTF Tarapur & Trombay, HART, TSSF

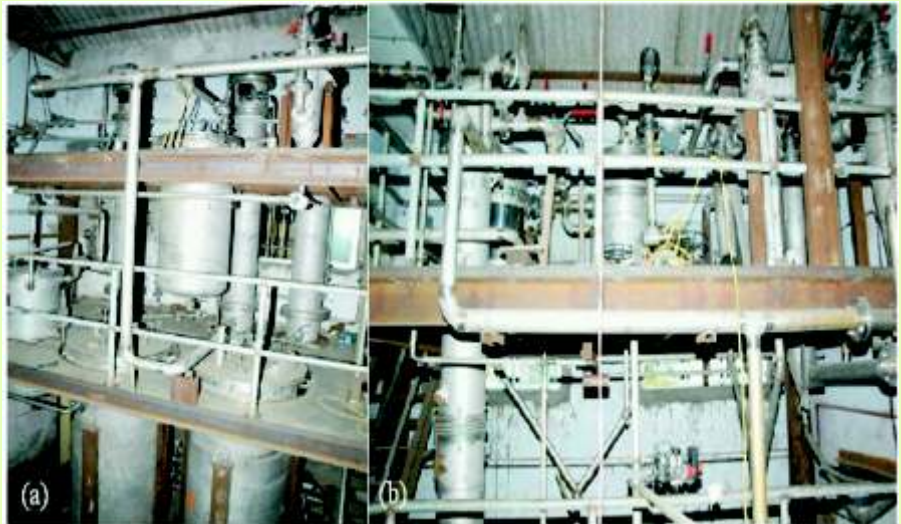

*Pilot plant views:*

*(a) scrubber system (b) gas-solid separation system*

# Nuclear Power Programme: Stage I

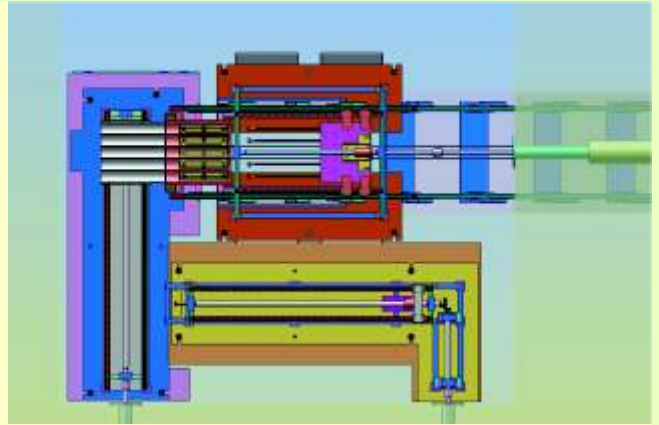
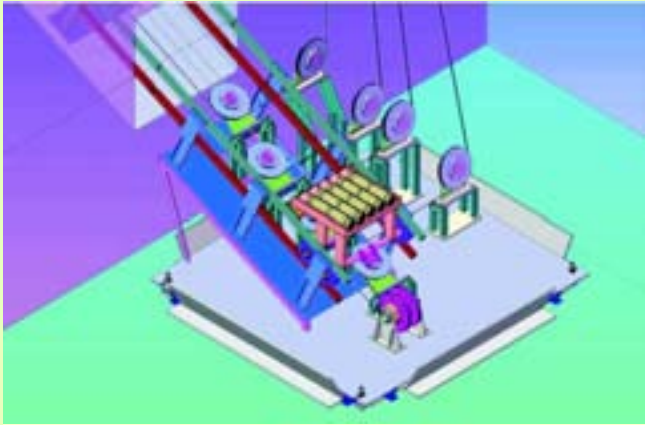

*Plan view of automation system : Pool Side and Inside the Cell View*

and FRFCF progressed well.

Development activity on thermal denitration of metal nitrates continued on bench scale. A Pilot plant facility was installed for studying the denitration of metal nitrates generated in the front end of nuclear fuel cycle and to generate scale up data.

Design and development of an automated direct fuel transfer system for nuclear reprocessing plants was taken up. To demonstrate the system layout and its functioning, a table-top

working model was assembled. A method using laser induced breakdown spectrometry was developed for the determination of Platinum Group Metals in simulated high level liquid waste (HLLW) without separation of matrix.

At Trombay, production of natural uranium metal for research reactor fuel fabrication and specific grade uranium metal powder for strategic use continued. All the solid slag, scrap and liquid streams were processed to recover purified ADU for recycling in the process streams. Test batches of ADU and UO<sub>3</sub> powder were prepared and characterized from Turamdih and Jaduguda uranium ores. Excellent metal grade powder of similar microstructure and physical properties could be produced from both sources. Processes were developed for the recovery of Yttrium from co-extracted Uranium from phosphoric acid and for the recovery of organic solvent di-nonyl phenyl

phosphoric acid (DNPPA) from the return phosphoric acid.

A technological process flow sheet was developed to extract uranium from the Gogi ore deposit located at Gulbarga District, Karnataka. This ore was the highest uranium content in the uranium ore deposits discovered so far in India. Process development studies were carried out on the Gogi ore samples on both bench and large scales.

A technological process flow sheet based on sodium carbonate-sodium bicarbonate combination as leachants and air/oxygen as oxidants was developed. This flow sheet will have near zero liquor waste generation. Feasibility of the single step dry process for reduction of UF<sub>6</sub> was successfully demonstrated and a few hundred grams of UF<sub>4</sub> was produced. Development of an alternative dry process based on thermal plasma was taken up. A novel three stage crystallization process was developed and demonstrated on pilot scale for

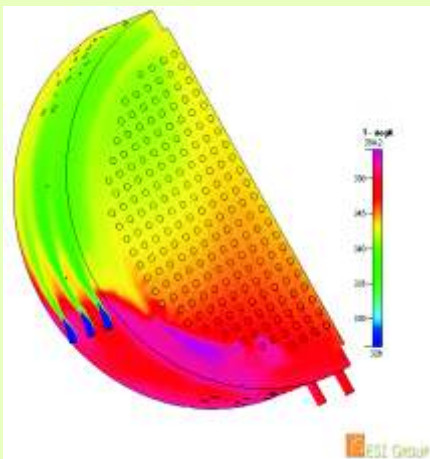

*Overall temperature contour*

# Nuclear Power Programme: Stage I

recovery of anhydrous sodium sulfate from the filtrate of sodium di-uranate precipitation. An improved hydrophobic catalyst, based on new support and deposition technique, was developed for hydrogen isotope exchange reaction to be used in the Combined Electrolysis and Catalytic Exchange (CECE) process and the process equipment and electrolytic cell installation is completed.

## HEALTH, SAFETY & ENVIRONMENT

NPCIL maintains the highest standards of safety within the Nuclear Power Plants (NPPs). The occupational radiation exposures of employees of the NPPs were maintained within the stipulated limit of AERB. The environmental dose due to releases of radioactive effluents from the NPPs were maintained significantly low (average less than 1% of the limits specified by AERB).

International Peer reviews of TAPS-3&4, RAPS-2 and RAPS-3&4 by World Association of Nuclear Operators (WANO) was carried out successfully. During the year, the Corporate Reviews were also carried out for MAPS and KGS-1&2. In addition, self assessment/internal reviews were also carried out for KGS-1&2 and MAPS. The radiological safety aspects of preliminary safety assessment report (PSAR) of KAPS-3&4 (700 MW) and dose apportionment and radiological



*Containment Model construction completed at Tarapur*

impact assessment (RIA) of RAPS 7&8 (700 MW PHWRs) were also reviewed and finalized.

The Environmental Management System and Occupational Health and Safety Management System as per ISO-14001: 2004 and IS-18001: 2000 respectively, were implemented and maintained at all operating stations. Behavior Based Safety (BBS) program was an added safety management aspect focused during the year 2009-10.

## Reactor Safety Analysis

Initial core load pattern with deeply depleted uranium (DDU) bundles was worked out. The reactor criticality and low power physics experiments were conducted successfully and

prediction matched closely with observation. The optimum loading pattern for trial irradiation of slightly enriched uranium bundles was worked out with the objective to achieve a burnup of more than 15000 MWD/TeU and subjecting it to power ramps within design limits. After obtaining the necessary clearance from safety committees, 51 such bundles were loaded in 14 channels in MAPS-2 core.

The containment design for 700 MW using current state-of-the-art methodologies in line with the international practice was evolved. The LOCA analysis at various locations and spectrum of break sizes were done to fix the containment design parameters. Hydrogen Recombiner Test Facility was developed for testing



# Nuclear Power Programme: Stage I



*Cruciform specimen being tested*



*Compliance test specimen on testing machine*

hydrogen recombiner to be implemented in IPHWRs for hydrogen management under severe accidents. Severe accident analyses are completed for all IPHWRs. Safety analysis codes validation and verification, for containment analysis and severe accident analysis, was carried out using PANDA code in line with IAEA methodologies. Integrated Leakage Rate Test and Structural Integrity Test were performed for containments at RAPS-5&6 and observed leak rates along with other structure related parameters were within permissible limits.

Shutdown PSA was completed

for KAPS. Level-1 PSA of BWR is revised to comply with present international standards. NPCIL is actively involved in the development and testing programme of the first indigenous development of general purpose CFD Code Anupravaha, which is jointly being developed with BARC and IIT Kanpur.

In the present configuration of 700 MWe calandria for the Kaiga Nuclear Power Plant, there is a need to predict moderator circulation patterns and temperature distribution to ensure adequate cooling margin for all channels by removing about 123 MW of heat generated in moderator at full power. The analysis at BARC showed that the maximum temperature observed in the calandria was within the design limits during normal operation.

For safety assessment of Indian PHWR containment under overpressure accident, a 1:4 size model of 540 MWe PHWR

containment will be tested up to the ultimate load capacity at Trombay. The construction and embedded sensor installation for BARC Containment (BARCOM) Test Model at Tarapur was completed.

A concern about the stability of spent fuel tray stacks during an earthquake event had forced to restrict the stack height to 20 trays in the spent fuel storage facility at Tarapur. This concern was now addressed by conducting a shaketable test in which a 30 tray stack was shown to be stable at the postulated earthquake level. The test has enabled regulators to

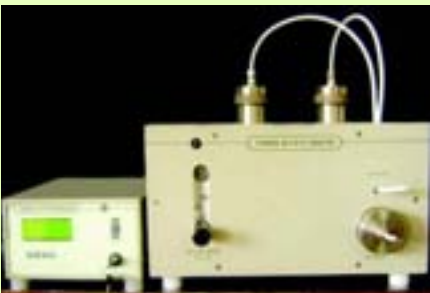

*On-line thoron monitor for thorium processing facilities*



*Personal badge dosimeter using DTPS/DRPS*



# Nuclear Power Programme: Stage I

authorize stacking of trays in stacks of 30 trays thus permitting utilization of the full capacity of the facility.

In the area of fatigue/fracture, tests were conducted on cruciform specimens to investigate the effect of biaxial loading on fracture.

Experiments were performed on full-scale real life sized beam-column joints under quasi-cyclic excitation to evaluate their performance under the event of earthquakes. The load-deflection characteristic and the crack pattern matched well with predictions by finite element analysis using microplane model for concrete.

Network architecture was designed and set up as a part of development of online diagnostic system for 220MWe PHWRs. Software was developed for simulating the large break LOCA scenarios using artificial

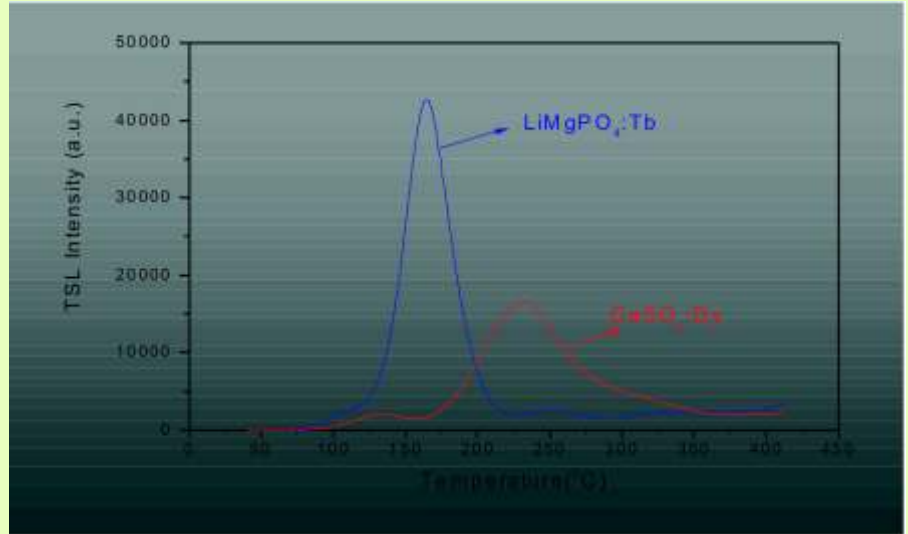

*CW-OSL curves of LiMgPO<sub>4</sub>:Tb,B and Al<sub>2</sub>O<sub>3</sub>:CTSL glow curves of LiMgPO<sub>4</sub>:Tb and CaSO<sub>4</sub>:Dy phosphors (470 nm stimulation)*

neural networks.

A new Indian Environmental Radiation Monitoring Network (IERMON) system was developed consisting of multiple radiation detectors for redundancy and extended range of

measurement. It consists of redundancy in data communication by having different data communication channels such as GSM, PSTN, VSAT and fiber optic cables.

A real-time, microprocessor



*Semi-automatic OSL Dosimeter Reader system*



*Image Analysis system analog CCD camera (A), Pentium P-IV PC (B). A sliding tray (C), image of tracks (D) is seen on monitor*

# Nuclear Power Programme: Stage I



*Abnormal glow curve with TLD badge reader*

technique for counting recoil proton tracks in SSNTD based CR-39 detectors and the minimum measurable dose was improved to 0.15 mSv. Dose response is linear upto 5 mSv with an accuracy  $\pm 7\%$  and saturation beginning at 20 mSv. Hence, the acceptance criterion for track counting was broadened and optimized.

A technique is developed to identify abnormal glow curves based on digitization, normalization and then division of glow curves into five equal parts on time scale. Based on the relationships in area between the parts, conditions are evolved for identification of abnormal glow curves. The method is well tested for glow curves obtained in regular monitoring and found to be suitable to identify abnormal glow curves for readings as low as 150  $\mu$ Sv equivalent.

A systematic study was carried out to find the response of the three TLD discs based on  $\text{CaSO}_4:\text{Dy}$  phosphor (1) under metal filter, (2) under Perspex filter and (3) under open window of the TLD badge using FLUKA Monte Carlo code.

A 'Free Air Ionization Chamber' for standardization of Synchrotron Radiation (SR) (very low energy X-rays) field and a plain walled Aluminum foil ionization chamber for monitoring of such low energy photon radiation field were developed. The development will form the basis for actuation of safety interlocks in the presence of scattered SR radiations.

based thoron gas monitor was developed for the measurement of thoron gas concentration in stack, pipe and working environments of the thorium processing facility.

Direct Radon/Thoron Progeny Sensors (DRPS/DTPS) for measuring time averaged radon/thoron progeny concentrations were integrated to develop personal badge dosimeter for inhalation dosimetry of workers of Uranium mining and thorium processing facilities, and for population dosimetry in high background radiation areas of Kerala. In order to register solely the attached component of the progeny atoms, wire-mesh capped DTPS/DRPS were developed.

Optically Stimulated

Luminiscence (OSL) dosimeter badge (based on  $\text{Al}_2\text{O}_3:\text{C}$ ) and an OSL badge reader system were developed. Studies on the feasibility of their use in personal dosimetry applications was taken up.

$\text{LiMgPO}_4:\text{Tb}$  and  $\text{LiMgPO}_4:\text{Tb,B}$  phosphors are very sensitive materials for Optically Stimulated Luminiscence (OSL) and Thermal Luminiscence (TL) applications. Comparison of the OSL curves of  $\text{LiMgPO}_4:\text{Tb,B}$  with  $\text{Al}_2\text{O}_3:\text{C}$  (Landauer, Inc) phosphor revealed the OSL sensitivity of  $\text{LiMgPO}_4:\text{Tb,B}$  is about 1.8 times to that of  $\text{Al}_2\text{O}_3:\text{C}$ .

Neutron dosimetry method was upgraded using image analysis

# Nuclear Power Programme: Stage I



*Free Air Ionization Chamber*



*Thin walled Al Ionization Chamber*

Aerial Gamma Spectrometry System (AGSS), developed to map large scale contamination on the ground or to search lost/abandoned radioactive source, is integrated with Advanced Light Helicopter. A Compact Aerial Radiation Monitoring system (CARMS) that can perform similar function without characterizing the radiation was developed for Unmanned Aerial Vehicle.

A monitor for continuously monitoring Tritium-in-air, with multi-stream sampling feature, was developed. This was in-built compensation facility for external gamma and gaseous Xe-133(FPNG) interference.

A centralized National Occupational Dose Registry Network System (NODRS) was set-up to maintain and update yearly and life time dose data of all monitored radiation workers in India. TLD labs and Health Physics Units at all the nuclear

power plant sites were linked by networking to the main dose registry server through NPCNET and ANUNET. This is a database management information system providing online information dose data as well as personal information about the radiation workers and will store biometric (Finger prints and photographs) information which will help in tracking the movement of radiation workers within DAE units. Presently, almost all local centres are using this system for daily dose recording activities of

their units. This system has more than 3.5 lakhs of records of radiation workers in the country from 1953 onwards. A pulsed gamma irradiator was developed using Co-60 source to test nuclear detectors that respond to a very short but high intensity gamma pulse.

A project undertaken under the MoU entitled “Extensive inhalation and external gamma radiation dosimetric studies for assessing effects of low and chronic radiation exposures on the health of human populations in the Monazite bearing areas in Kollam and Alleppy districts, Kerala” was completed during the year. The study, based on “case control” methodology, indicated that the radiation exposures received by cases and controls were not significantly different from each other. The analysis further indicated a lack of statistically significant association between radiation exposure and the congenital malformations under study.

Estimation of distribution coefficient for natural radionuclides in geological



*Tritium in air monitor*



*The Compact Aerial Radiation Monitoring System*



# Nuclear Power Programme: Stage I

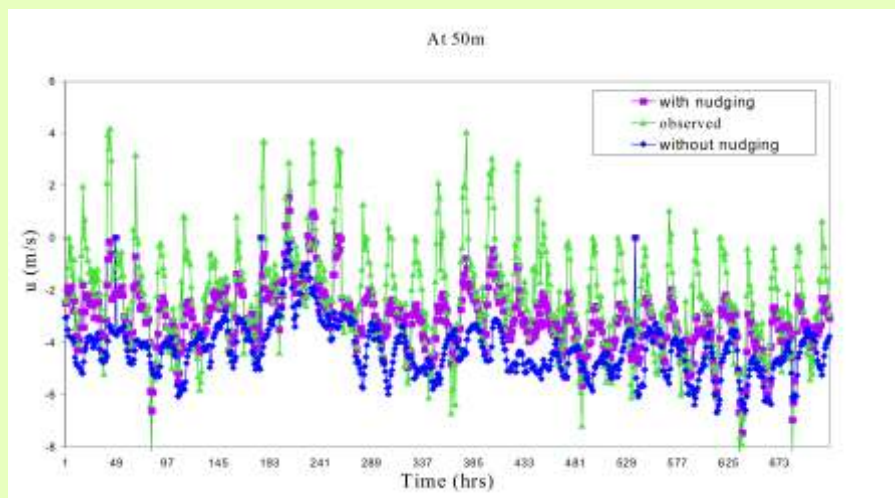

*Time series of the zonal wind at 50 m height with & without nudging & their comparison with observed data*

hill behind the Plutonium Plant in Trombay on dispersion of pollutants.

The radiological impact of natural erosion of ore material due to overland flow of water which is accumulated from rainfall and ultimately reach the nearby surface water body of U-238 and its progenies in large reservoirs was estimated using a hydrological dispersion model. The estimated total annual effective dose through the drinking water pathway was 25 times less than the guide line for drinking water pathway (0.1 mSv/y), recommended by the World Health Organization.

The radiological impact assessment of the uranium tailings pond at Turamdih was carried out using FEFLOE, a finite element based groundwater flow and contaminant transport model. The results showed that the concentrations of these radionuclides and the corresponding annual effective dose rates to members of the public were less than the corresponding standards even at the shortest distance of 1.0 km from the centre of the tailings pond. The radiological impact in groundwater at this distance is practically nil up to a period of 4000 years and is trivial beyond this period.

Radiochemical pre-concentration of Cs-137 on copper ferrocyanide coated acrylic fibre was standardized to evaluate extremely low level fallout background Cs-137

matrices around Uranium mining site was carried out. Characterization of soil and ground water and its impact on distribution and transport of trace metals and radionuclides from Uranium tailings was studied. Methodologies were developed and applied for assessment of toxic pollutants including heavy metals, organopollutants and radionuclides at ultra trace levels in different environmental matrices. Polymeric sorbents was used for uptake and recovery studies of radionuclides and toxic metals. Radiation doses to member of the public in northern corridor of India from intake of naturally occurring radionuclides ( $^{238}\text{U}$  and  $^{210}\text{Po}$ ) in drinking water were evaluated.

Size segregated air borne particulate matter were collected at Trombay and Vashi and analysed for different trace metals and ionic composition using

various analytical techniques. Receptor modeling techniques were applied to identify major sources at both the locations.

The Gaussian Plume Model (GPM) was modified based on virtual source method to study the atmospheric dispersion of pollutant in the presence of structures taller than stack, e.g. cooling towers. The results obtained using this modified GPM were validated using sophisticated Computational Fluid dynamics (CFD) based model PANEPR. The modified GPM thus developed was applied for estimation of annual average concentration of a passive tracer for Kakrapar Site, considering effect of four cooling towers.

The wind flow field for the Kaiga Site is simulated using the Air Pollution Model (TAPM) for a period of one month.

CFD-based model PANEPR was used to study the effect of the



# Nuclear Power Programme: Stage I

activity in large volume aquatic samples. Bioaccumulation factors of naturally occurring radionuclides Po-210, Ra-226 and Ra-228 were estimated in pelagic fishes in the environment of Kudankulam. Organically found tritium was estimated in aquatic organisms near discharge locations of NPPs using sample oxidizer. Dilution available in Motichur lake at KAPS was evaluated using discharged H-3 as tracer.

As part of the quality assurance programme, an intercomparison exercise was conducted to evaluate performance of different whole body monitors in operation at various nuclear power plants of DAE. Fission track analysis technique for estimation of U (nat.) in solution was standardized and applied for estimation of U (nat.) in urine samples collected from members of public.

Radiation protection, industrial hygiene and environmental surveillance were continued at all the Nuclear Power Plant sites and BARC, Trombay and other facilities of DAE. The study found no significant change in the concentration of radionuclides measured in environmental samples compared to earlier years. Radiological Protection services were provided for potentially radiation exposure intensive jobs such as Enmasse Coolant Channel Replacement jobs at NAPS and KAPS and Enmasse Feeder Replacement job at RAPS-2. Occupational workers were whole

body counted to evaluate internal dose. The internal dose to all the occupational workers as well as members of general public were much lower than the limit prescribed by regulatory board. No significant change in the concentration of radionuclides measured in environmental samples compared to earlier years was observed.

Environmental baseline study of uranium mining project at K-P Mawtabah (Meghalaya) was completed. A study was carried out to assess the radiological impact on the Indian coastal marine environment due to nuclear power activities as a part of IAEA project. Analytical support was also provided to various divisions of BARC and other units of DAE for low level radioactivity measurement. Adequacy of the design of shielding for hot cell for manufacture of vitrified Caesium-137 pencils was assessed from radiation point of view. Ground water modeling keeping in mind the transport of tritium, was completed at the KAPS site, Kakrapar during 2009.

Twenty Automatic Weather Stations (AWS), developed by ISRO, were installed at various sites of DAE under ISRO-BARC collaborative research programme. The data collected included temperature, pressure, wind speed, wind direction, humidity, sun shine and rainfall on a continuous basis. A real time online decision support system as a nuclear emergency response

system for handling offsite nuclear emergency at Nuclear Power Plants developed under the frame work of "Indian Real time Online Decision Support System "IRODOS" continued its operations at NAPS, Narora and at Emergency Response Centre, BARC, Trombay. Impact Assessment Software (IAS) developed to assess the impact of a nuclear event was integrated with the Geographical Information System (GIS) for hazard prediction and decision support during response to such events.

## RESEARCH AND DEVELOPMENT

Development works undertaken by the R&D Directorate of NPCIL were focused towards enhancement of plant safety, improvement in plant performance parameters, reducing project gestation period, indigenization of plant components, development of techniques for future decommissioning of power plants, safety experiments for validation of analysis codes etc. The specific areas of in-house R&D were the Nuclear and Electronics Systems.

### *Major R&D works in Nuclear System*

Civil construction of Integrated Test Facilities, Tarapur (ITFT) building at Tarapur to facilitate thermal hydraulic experimental studies related to Advanced Heavy Water Reactor, 700 MW

# Nuclear Power Programme: Stage I

Pressurized Heavy Water Reactors and Testing of Fuelling Machine of AHWR were undertaken. Following major development works were completed:

- Rehabilitation & up-grading of hydro-lancing machine for 220 MW steam generators
- ◆ Turbine Missile Shield
- Procurement & supply of 2 Nos. Type-B (U) approved flask for transportation of irradiated materials
- 700 MW containment cooling spray system
- ◆ Design of indirectly heated 7-element & 37-element electric heater bundles for NTTF

Testing, supply & deployment of shielded flask and cutting - crimping tools for removal of Cobalt-60 sensors of irradiated KAPS-1&2 SPNDs, testing & supply of modified feeder cutting machine, commissioning of Laser Based Feeder Cutting Machine at R&D Center etc. were approaching completion.

## **Major R&D works in Electronic Systems**

Following major development works were completed during the year:

Digital recording system software up-gradation at KAPS-1

Up-gradation of hardware and software of Process Control System, computerized channel temperature monitoring system, radiation data acquisition system

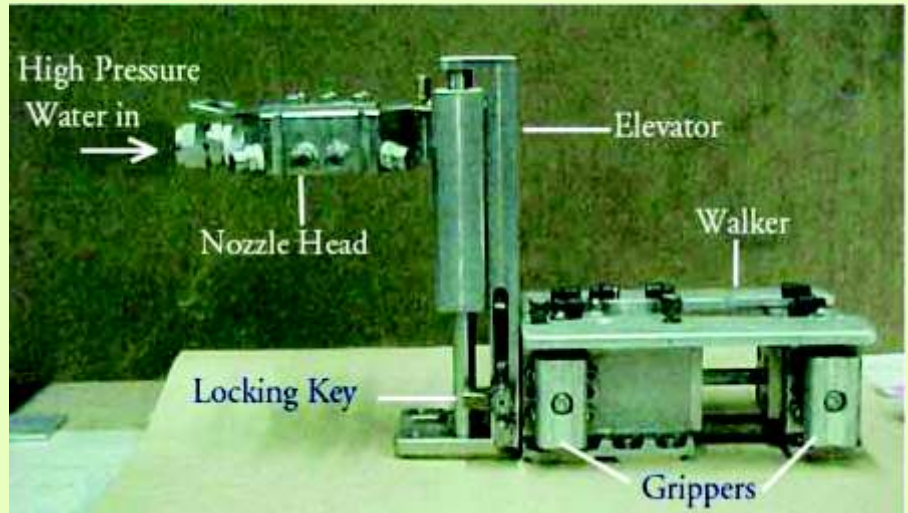

*Jet Manipulator Assembly of SLE*

and digital recording system at KGS-1 and RAPS-3&4

## **R&D at BARC**

### **Pressurised Heavy Water Reactor**

The Sludge Lancing Equipment (SLE) for periodic removal of corrosion deposits from steam generators of the nuclear power plants was re-commissioned by BARC and deployed successfully for lancing of all four steam generators of KAPS-1.

Design of Tool Delivery System for various tools required for In-Service Inspection (ISI) for 220 MWe PHWR was completed

A Channel flow arrestor assembly was designed, developed and tested for 540 MWe PHWR. After defueling, fuelling machine installs the assembly in the end fitting to block the channel flow at the time of ice plugging.

Ultrasonic Measurement of Axial Creep system for measuring axial creep of coolant channels was designed, developed and supplied to all the operating PHWRs of NPCIL. This uses ultrasonic sensors for scanning the reactor face with the help of fuelling machine and accrues the benefit of reduced time for creep measurement.



*Channel Flow Arrestor Assembly*

# Nuclear Power Programme: Stage I



*UMAC - Operator Interface Programme*



*Data acquisition System*



*Sensor Mounted in FM snout*



*Ultrasonic Sensor for UMAC*



*Failed specimens and the corresponding pressures*



*Large Size Elbows Test Specimens*

An Advanced Drive Machine (ADM) was designed for in-service inspection of coolant channels for 540 MWe PHWRs.

An advanced version of Flux Mapping Software was also developed for TAPP-3&4. The new version was verified and validated and installed in TAPS-3&4 NPP's.

Studies on the use of thorium in the 19 and 37 element fuel assembly of PHWR along with Slightly Enriched Uranium (SEU) revealed that about 9-10 kg <sup>233</sup>U can be produced with a single thoria rod and about 70 kg can be produced with 7 thoria rods. The results indicated that there will be substantial saving in the mined uranium resources.

Mechanical properties of Zircaloy cladding from irradiated PHWR fuel pins with burn ups of 4,400MWD/t and 15,000 MWD/t was measured inside the hot feeders removed from RAPS after 15.67 effective full power years service, during en-masse feeder replacement programme were examined to evaluate the

flow assisted corrosion.

Development of BARCIS for 540 MWe PHWRs and tools and techniques to measure gap between Calandria tubes and horizontal reactivity devices in PHWRs was taken up.

Quality Assurance was performed during fabrication of fuel for research and power reactors and various critical equipments manufactured by BARC.

Advanced ultrasonic Non-Destructive Examination method was developed for detection of cracks in turbine blades of pressurized heavy water reactors and feed water nozzles & pipelines of boiling water reactors. Different types of Pipes/Elbows and large size Cruciform test specimens for Advanced Component Integrity Test Program and Life Management Studies of 235 MWe & 500 MWe PHWR were fabricated.

## **LWR (Light Water Reactors)**

As a part of the VVER core



# Nuclear Power Programme: Stage I

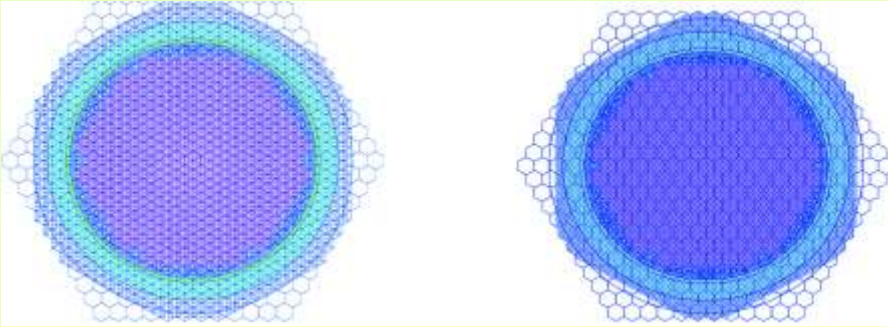

*Ring Solution by Incomplete Choleski Decomposition Method*

analysis, a more detailed grid for fuel and coolant temperatures, coolant density and xenon loads was used in EXCEL for better representation of the physical state of the reactor. WIMS data libraries based on JEFF-3.1 and ENDF/B-VII were updated with actinide data up to 252Cf and temperature for resonant nuclides was increased up to 2500 K. Detailed analysis of eight fuel cycles were performed with the diffusion code TRIHEX-FA using the updated database. EXCEL-TRIHEX-FA-HEXPIN reactor physics code system was validated by analysing a set of TIC (Temporary International Collective) experiments conducted at Budapest, Hungary, during 1972-1990 and OECD Benchmark on VVER-MOX loaded Core. A superior ring solution method for circular ring layers of hexagons or triangles by incomplete Choleski decomposition method was developed.

Development of Canned Motor Pump was taken up.

Innovative procedures were devised for manufacturing of the parts and sub-assemblies of the pump. The pump assembly was subjected to Helium leak test and Hydro-test (250 bar) to check the integrity of Stator Can weld joints and found to be satisfactory. A number of set ups, fixtures, tools and processes were developed for machining the Suspender tube which is a high precision, delicate, thin walled, very flexible, tubular section component.

A process flow-sheet was developed for production of low density gadolinium aluminate



*KARP, Kalpakkam*

powder used as a burnable poison in the light water reactor. Powder with natural gadolinium concentration of 0.1 g/cc was prepared.

## WASTE MANAGEMENT

The Waste Management Facilities at Trombay, Tarapur and Kalpakkam were operated safely for collection, segregation, storage and treatment of radioactive waste. The discharge of activity to the environment was kept well below the prescribed regulatory limits. At WIP, Trombay, installation of new systems to enhance the throughput of the plant are in progress. Transportation of vitrified waste products from WIP, Trombay to Solid Storage Surveillance Facility (SSSF), Tarapur for interim storage continued.

At WIP Tarapur, about 200 cum of intermediate level waste (ILW) was processed using mobile module employing indigenously prepared resin. Concentration of HLW continued and ~250 cum of the waste was processed. Setting up of a demonstration facility for decommissioning of Joule Heated Ceramic Melter continued at Trombay. Alpha waste transit storage facility at RSMS, Trombay was also operated safely.

At Central Waste Management Facility (CWMF), Kalpakkam,

# Nuclear Power Programme: Stage I



*Actinide Partitioning  
Demonstration Facility*

the facility for melt densification of polythene/plastic waste was successfully adopted for treatment of such waste from MAPS. Air cleaning services for insitu testing of HEPA and iodine filter banks were provided to various units at Trombay, Tarapur and Kalpakkam.

The engineering scale demonstration facility for partitioning of actual high level waste is nearing completion at Tarapur. This facility is state-of-art-technology and will be a step towards reduction in radiotoxicity associated with high level waste. Setting up of cesium separation plant with actual high level waste progressed.

Microbiological characterization of the biomass

generated in the 2.5 m<sup>3</sup> per day capacity bioreactor for treatment of nitrates in radioactive low level liquid effluents was completed. About 300 mCi of pure <sup>90</sup>Sr was separated from HLW and was used to extract carrier free <sup>90</sup>Y. About 100 mCi recovered <sup>90</sup>Y was made available for R&D studies. <sup>106</sup>Ru (specific activity 300 mCi/l) is supplied on regular basis for treatment of eye cancer. <sup>241</sup>Am recovered from old plutonium scrap is made available regularly for strategic application. For the development of Cold Crucible Induction Melter (CCIM) technology, the process parameters were standardized using simulated HLW. An effective off gas treatment loop was hooked to CCIM set-up for handling oxides of nitrogen for full scale demonstration.

A programme for setting up of an Underground Research Laboratory (URL) at a captive site in granite formations was initiated. The URL will simulate the geological environment for mock-up experiments related to the disposal of high level vitrified waste.

Expertise in the field of waste safety was provided to

AERB/BSC for review of various waste safety documents eg. guides and codes. Expertise in the field of reprocessing and waste management was provided to IAEA, Vienna by participating in co-ordinated research programme, technical meetings, document review etc.

Design of continuous dissolver required for large size reprocessing plants was completed and action for making proto type was taken. A programme for the development of refractories that could withstand high temperature glass and acidic waste required for the vitrification melters was taken up within the industry in collaboration with CGCRI.

## International Co-operation

NPCIL contributed in enhancing safety & reliability of nuclear power plants globally through its active participants in World Association of Nuclear Operators (WANO), Candu Owners Group (COG), etc. programmes. NPCIL contributed in WANO Peer reviews, Good practices programmes, performance indicators, technical exchange & training programme of WANO.





# Chapter : 2

## Nuclear Power Programme : Stage-II : Fast Reactors



*Prototype Fast Breeder Reactor's Main Vessel Erection (Bhavini)*

# Nuclear Power Programme: Stage II

The second stage of nuclear power generation programme is geared towards setting up of fast breeder reactors. These reactors produce more fuel than what they consume.

The Indira Gandhi Centre for Atomic Research (IGCAR) was engaged in the design and development of liquid sodium cooled fast breeder reactors in the country, along with associated fuel cycle technologies. At IGCAR, the fast reactor programme is supported by research and development in a variety of disciplines including reactor engineering, chemistry, metallurgy, material science, safety and instrumentation.

BHAVINI, a public sector undertaking of the DAE, is responsible for the building of commercial fast breeder reactors. At present, this company is constructing a 500 MWe prototype breeder reactor at Kalpakkam.

BARC is also contributing towards the research and development of fuels for fast reactors, technology for reprocessing of fuels, waste management and health and safety of the work force.

## **PROTOTYPE FAST BREEDER REACTOR**

Bharatiya Nabhikiya Vidyut Nigam Ltd. (BHAVINI), is setting up India's first commercial 500 MW Prototype Fast Breeder Reactor (PFBR) at Kalpakkam, Tamil Nadu.

PFBR is a pool type reactor using mixed oxide of uranium and plutonium as fuel. The coolant used is liquid sodium. The committed date of criticality is September-2010.

During the report period, the civil construction of Nuclear Island buildings approached completion. The Nuclear Island houses totally 17 buildings, out of which eight buildings namely Reactor Containment Building, Steam Generator Buildings (2Nos), Electrical Buildings (2Nos), Control Building, Radioactive Waste Building and Fuel Building are connected together as a single structure on a common raft and is called Nuclear Island Connected Buildings (NICB). The common raft foundation covers an area of 100m

X 100m, and the operating floor level is at EL 30m. Surrounding structures like Ventilation Stack, Horton Sphere were completed. Diesel Generator Buildings was also completed.

The Reactor Vault (RV) is the critical civil structure in PFBR which houses all the reactor assembly components. The Safety Vessel, which has inner radius of 6750mm and weighs 165MT including reflective Thermal Insulation Panels was successfully installed in the RV using a heavy duty crawler crane. Subsequently, the Upper Lateral Liner assembly erection was completed and the concreting was in advanced stage of completion. Around RV a dust-free environment was created and a



*Nuclear Island connected Building*

# Nuclear Power Programme: Stage II



*Erection of Main Vessel of Prototype Fast Breeder Reactor*

temporary ventilation system was provided. The 12.9m Dia and 12.8m tall Main Vessel is made up of 316LN stainless steel. MV weighing about 296 tonnes of thin walled structure was lowered into the Safety Vessel from a distance of 57m.

All the four numbers of Argon Buffer Tanks were erected and positioned in the reactor building. About 1027 mn tons of sodium metal was transferred safely in Sodium Storage Tanks and Argon Buffer Tanks (ABT). The structural works of SGB 1&2 was completed up to EL 84m.

In Fuel Building the slab at EL 62m was completed. The entire civil structural works of Electrical Building 1&2 was completed and the 6.6kV Switchgear panels and 3 sets of Batteries in Electrical Building were erected in position. In the Control Building, 4 Nos. of HCR

panels were erected in position.

RAD Waste Building was completed and in-situ fabrication of effluent treatment tanks were

commenced, also SS lining works for the cells at EL 30m was completed.

The construction of Diesel Generator Building (DGB-1& 2) was completed and the 2 nos. of 4500 kVA diesel generators were erected in position.

Liquid waste management plant building works were commenced & the main raft was completed.

Fabrication of 3nos of Horton spheres (for storage of high pressure nitrogen & argon gas) was completed. After carrying out the shot blasting & zinc silicate primer coating the hydro tests were completed successfully. The painting works was in progress.

Manufacture of long delivery critical items like Safety Grade Decay Heat Exchanger & Air Heat



*Inner vessel (Bhavini) of Prototype Fast Breeder Reactor*



## Nuclear Power Programme: Stage II



*6.6kV Switchgear panels (Bhavini)*

Exchanger, Pump & Intermediate Heat Exchangers, Large Rotating Plug, Small Rotating plug and large diameter Sodium pipe fittings reached advanced stage of progress at various industries.

Core Catcher (CC) & Core Support Structure (CSS) are integrated with Main Vessel (MV) and the welding of MV cooling pipes was completed. The MV of 12.9m diameter and 12.8m tall weighing about 296 tonnes made of 316LN stainless steel along with the CC, CSS was erected in to the SV. The integration of Grid Plate which holds the fuel sub assemblies (FSA) was completed with the Primary Pipe and preserved in nuclear clean condition. The fabrication of Inner vessel was completed and Roof slab fabrication was in advanced

stage of completion at Site Assembly Shop, Kalpakkam.

100% works of the sea water outfall channel were completed. The Seal pit Inlet & Seal pit outlet was constructed. The connection of PFBR outfall channel & MAPS outfall channel was completed and connected to seal pit. The 50m deep vertical diaphragm outlet shaft for Sea-water intake and the horizontal tunnel, length 565 m was completed. Also the concrete lining works for 108m was completed.

The Balance of plant houses the Turbine Building, Raw-water & Fire-water pump house, De-Mineralization plant (DM plant), Auxiliary Boiler plant, Effluent Treatment plant and Open reservoir. The finished floor level of Power Island is at EL 27.50m

which is 2.5m below the finished floor level of NICB (EL 30m).

The Construction of Turbo-generator Deck Slab at EL 23.46m was completed and the fabrication of shuttering & supporting structure arrangement for TG Deck top slab (EL 41200 to EL 43500/44380) is in progress.

In Raw-water & Fire-water pump house, 80% of Plastering work (EL 27560 to EL 35700) and 80% of Monorail erection work was completed and laying of acid alkali floor tiles is in progress.

In Sea Water Pump house the entire raft was completed & the construction of counter-fort retaining wall was in progress.

100% of civil construction of the open reservoir was completed.

The construction of 230KV Indoor Switchyard GIS Building was completed, the 70MVA station transformer was erected. The GIS equipment erection was completed & the vacuum pulling & nitrogen gas filling works are in progress. The GIS bus duct supports alignment was completed. The excavation for 230kV tie line from MAPS was over & the Laying of HDPE pipes was completed at MAPS boundary wall.

The site works for various systems like Air Conditioning & Ventilation system, Raw & service water system, compressed air generation system and tele-communication system were commenced in Electrical Buildings (2Nos), Control Building, Radioactive Waste Building, Service Building &

## Nuclear Power Programme: Stage II

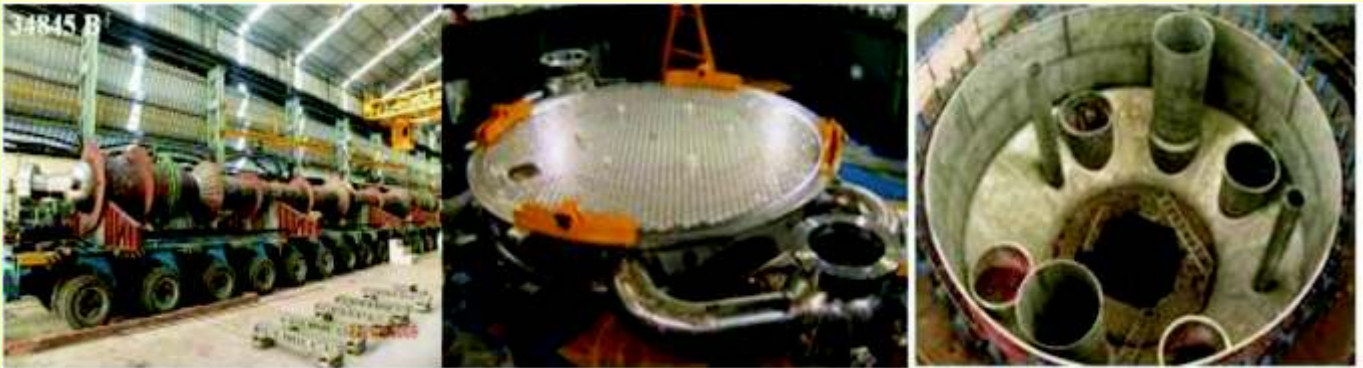

*Steam Generator, Grid Plate and Inner Vessel of Prototype Fast Breeder Reactor*

Service Water Pump House made progress.

The project achieved an overall physical progress of 52.5% as on December-2009.

At IGCAR Integration of grid plate with primary sodium piping, inner vessel along with standpipes, transfer of additional sodium from the tankers to the storage tanks, manufacture of an intermediate heat exchanger, a decay heat removal heat exchanger, a steam generator, and a secondary sodium pump were completed.

Core Disruptive Accident (CDA) scenario leading to mechanical energy release was updated. Thermal hydraulics and structural mechanics analyses of main vessel with internals were completed for 100 MJ of work potential.

A full scope replica type simulator was developed to impart comprehensive training on reactor subsystems under various plant conditions and enhance the capability of the plant operators.

### **RESEARCH & DEVELOPMENT FOR FAST REACTORS**

#### **Fast Breeder Test Reactor (FBTR)**

The 15th irradiation campaign was completed marking a major milestone for FBTR with the reactor outlet temperature reaching 482 °C and power raising to 18.6 MWt. One lead Mark-I Sub-Assembly (SA) loaded for endurance testing reached 165 GWd/t without failure. Six Mark-I SA in outer ring attained a burn-up of 155 GWd/t. The PFBR test SA reached a burn-up of 92 GWd/t as against the target burn-up of 100 GWd/t.

The reactor was shutdown for carrying out surveillance tests, modification works and fuel handling for commencing the 16th irradiation campaign. Visual inspection of reactor vessel using projector and periscope was carried out. Flows through the siphon break pipe and emergency injection pipe were found normal.

In the biological shield cooling system, sealing of two leaky coils was carried out in-house, using the chemicals supplied by BARC. Sodium outlet appendix cooling blowers were replaced with higher capacity blowers to limit the concrete temperatures during high power operation. Significant variation of steam temperatures was observed in the tubes of the steam generators during 15th campaign. Detailed investigation indicated dislocation of the orifice assemblies in most of the tubes. Replacement of the assemblies with a modified design was completed.

Periodic safety review of FBTR by AERB was continued. Life extension of FBTR was taken up. Starting air system of the diesel generator was upgraded and reactor containment building isolation dampers were replaced with state-of-the-art dampers.

Post irradiation examination (PIE) was conducted on a control rod assembly discharged from FBTR, after attaining a fluence level of  $5.0 \times 10^{22}$  n/sq cm to

# Nuclear Power Programme: Stage II

assess the irradiation behaviour of its structural and absorber materials.

A mock up irradiation capsule with five sub-capsules was successfully fabricated. Sodium filling in the sub-capsules was carried out in an argon atmosphere glove box and an innovative sealing method was successfully developed to seal the sodium-filling path in a leak tight manner. X-radiography examination was carried out on the mock up irradiation capsule to verify the internal configuration of the capsule. This capsule is ready for use in FBTR for generation of irradiation performance data on fuel cladding and wrapper tube materials of interest at desired higher irradiation temperatures.

At Fast Reactor Facility of NFC, manufacturing of 18 numbers of Mark-1 mixed-carbide assemblies, 52 numbers of hybrid core mixed-oxide assemblies and 20 numbers of steel reflector sub-assemblies for FBTR was in advanced stage.

## Future 500MWe FBRs

As a follow-up to PFBR, it is planned to construct six 500 MWe commercial fast breeder reactors (CFBR) with improved economy and enhanced safety. Task forces were formed to conceptualise the features to achieve economy, safety, optimum plant layout and high capacity factors submitted their reports.

Towards improving safety, passive safety features for the

shutdown systems, combination of active and passive decay heat removal systems, in-vessel sodium purification and application of innovations and novel techniques to efficiently handle the sodium fire issues and treating the CDA as non-energetic (however considering thermal consequences and post accident heat removal aspects), were under consideration.

Based on the construction experience being gained from PFBR, layout for the twin-unit plant to be built at Kalpakkam, was detailed out in the area earmarked near to PFBR. The important aspect of the layout is sharing of fuel & rad waste building, decontamination building, control building, switchyard, site assembly shop to be later converted to maintenance building.

Based on the feedback from design & construction experiences of PFBR, international trends on innovative design of FBRs, accumulated experience on FBRs and focused R&D during the last 40 years, significant capital cost reduction is aimed for the reactor assembly of CFBR Structural mechanics and thermal hydraulics analysis activities were carried out for finalising the detailed design. Three units of steam generators were selected per loop and the process design of the unit was completed with 30 m long tubes. The capital cost reduction of the reactor assembly components that could be achieved through these

improved concepts is estimated to be about 25 %.

The road map for associated R&D and manufacturing technology was prepared.

## *Quality Assurance and In-Service Inspection*

An innovative immersion guided wave based ultrasonic technique was developed for quality assurance of PFBR hexcan sheaths (length 3600 mm and thickness 3.2 mm) made of cold worked Alloy D9 (Ti-modified 316 austenitic stainless steel). This technique substantially reduced the inspection time as compared to the conventional angle beam inspection with similar defect detection sensitivity. This could reliably detect both outer and inner surface defects of the order of 6 mm x 200  $\mu\text{m}$  x 100  $\mu\text{m}$  (depth) in the hexcan sheath.

An efficient signal processing methodology was developed for detection of defects in expansion bend regions of steam generator (SG) tubes during in-service inspection using remote field eddy current technique. This methodology resulted in reliable detection of defects deeper than 0.23 mm (10% wall thickness) present anywhere in the bend regions of the SG tubes and also in the straight portions.

Microwave based Ground Penetrating Radar (GPR) imaging technique was used for identification of rebar-free locations in concrete structures



# Nuclear Power Programme: Stage II

near the FBTR containment wall and the hot cells of Waste Immobilization Plant. 3-D imaging using GPR has enabled effective drilling of 100 mm diameter holes without damaging the rebars and the structural integrity of the concrete structure.

Eddy current-GMR (EC-GMR) sensor developed in-house was successfully used to verify that there is no intergranular corrosion in weld and heat affected zones of low-level active storage 304LN stainless steel tanks of Demonstration Fast Reactor Fuel Reprocessing Plant (DFRP).

An eddy current testing procedure was developed for health assessment of evaporator and condenser tubes of chilled water plant. The procedure was applied to inspection of 786 tubes in evaporators and condensers successfully.

## ***Thermal Hydraulics, Component Testing and Validation***

### *Sodium Freezing studies in 400 NB Horizontal pipe Experiment & Analysis*

Experiments were conducted in sodium loop for the demonstration of the feasibility of freezing sodium to isolate a steam generator in PFBR.

### *SGDHR System*

A scaled down model of Safety Grade Decay Heat Removal

(SGDHR) system of PFBR, was successfully commissioned to demonstrate the feasibility of passive decay heat removal in PFBR.

SGDHR system removes the decay heat from the core and limits the core temperatures within the acceptable limits, when normal heat transport paths are not available. Studies were conducted to demonstrate the core coolability by natural circulation in the primary pool and the inter wrapper space.

### *Steam Generator Test Facility*

The Steam Generator Test Facility (SGTF) was operated continuously at various power levels. Endurance test of the

steam generator at rated parameter was successfully completed for a period of 4000 hours, bringing out the quality assurance in design and fabrication. Adjacent Tube Wastage Studies on SG Tube Materials were conducted.

### *Development of Sodium Flowmeters*

Permanent Magnet Flow Meter (PMFM) made with ALNICO-5 is used for measuring flow in sodium circuits. A new compact PMFM with Samarium-Cobalt (SmCo) magnet, which is having higher coercivity, 60% high sensitivity and energy product than ALNICO-5, was developed & used for stability



*Steam Generator Test Facility*

# Nuclear Power Programme: Stage II

testing of air gap flux density. These compact flow meters can be deployed in future reactors.

## Testing of Ultrasonic Under Sodium Scanner for PFBR in Sodium

An Ultra Sonic Under Sodium Scanner (USUSS) was developed for PFBR to detect any fuel sub-assembly projecting from its original location, which may hinder the fuel-handling operation

The scanner was tested in a test facility in water and then in sodium.

## Overflow type sampler for PFBR primary and secondary sodium circuits

Monitoring and control of impurity in sodium system is essential for trouble free operation of PFBR. An overflow type sampler was developed and employed at FBTR to eliminate segregation of impurities associated with the other sampling techniques. Similar type samplers will be utilised for the PFBR for primary and secondary sodium circuits.

## Design, Simulation, Testing and Calibration of Eddy Current Flow Meter for PHENIX

Eddy Current Flow Meter (ECFM) is used for flow measurement of liquid metal flows. A probe fitted with ECFM sensor developed was used for in-

core flow measurement in FBTR. A suitable ECFM sensor along with the associated electronics was supplied to CEA, France for core flow measurement in Phenix.

## Structural Mechanics

Based on application of random analysis approach and quantification of temperature attenuation of high frequency components, improved thermal striping limits were proposed for future reactors. The decay heat removal system consisting of more than one circuit has possibly of different designs to improve diversity and reliability. These systems were designed to work in fully passive mode or fully active mode or in mixed mode. Detailed assessment of various options, with respect to economy and operating experiences was made.

Innovative experimental facilities were commissioned for generating data for establishing/improving design rules for the mechanical design of FBR components.

Structural integrity assessment tests were completed to quantify the acceptable number of repair welds, for validating the seismic design of main vessel and safety vessel under seismic loadings when the main vessel is under leaked condition and for the seismic qualification of bearing system for large and small rotatable plugs.

## Control Systems

Real Time computer based



*Core assembly experimental facility*

systems are extensively deployed in the Instrumentation & Control systems of PFBR and VME bus was adopted as the standard platform for all categories of applications. As the computers are to be used for various applications including the safety critical, these were tested and qualified for environmental, EMI/EMC and seismic standards as per PFBR requirements.

## Sensors

Phase diagram studies of alkali and alkaline earth metal halides are important to develop hydride ion conducting electrolytes for use in electrochemical hydrogen sensors. The phase diagram of the pseudo-binary systems of  $\text{CaBr}_2\text{-CaCl}_2$ ,  $\text{CaBr}_2\text{-LiBr}$  and  $\text{CaBr}_2\text{-CaHBr}$  was investigated by Differential Thermal Analysis from room temperature to  $800^\circ\text{C}$ .

An electrochemical sensor for sodium aerosol using a sodium

# Nuclear Power Programme: Stage II

ion conductor, was developed. The sensor responded reproducibly to sodium aerosol bearing air. One sensor was tested in aerosol test facility.

## Reactor Safety

### Reactor Physics and Shielding

An important objective is improved economics and reduction of shield volumes in future fast breeder reactors. In-vessel shield is provided mainly to reduce the radiation induced activity of secondary sodium flowing through intermediate heat exchanger. Ferro-boron is identified as a promising shield material. Experiments were conducted to study attenuation behaviour of thermal, epi-thermal and fast neutrons in ferro-boron slabs and granules using the neutron beam of KAMINI reactor.

A theoretical study was made on the use of ferro-boron as in-vessel shield material in the design of CFBR.

### Environmental Safety

A round robin exercise was initiated on accurate wind flow simulation for Kalpakkam coastal site towards study of atmospheric dispersion, involving academic and R&D institutions. With improved design and increased safety systems of the new generation reactors, a study was made to explore the possibility of reduction in the current exclusion distance from 1.5 km. Towards this, the radiation dose and sodium aerosol concentration at the site

boundary were estimated in the case of a Core Disruptive Accident. On the basis of the studies, it was concluded that 0.7 km distance is adequate as exclusion zone from the safety considerations.

## R&D for Future FBRs

### Sodium Chemistry

In collaboration with the Central Electro Chemical Research Institute, Karaikudi a prototype portable electrochemical brush was developed for standardization of parameters for the hot spot decontamination like decontamination formulation using mixture of sulpho-phosphoric acid, applied voltage, polishing time.

## MATERIALS

### Materials Development and Characterisation

9Cr oxide dispersion strengthened ferritic steel fuel cladding tubes were developed in collaboration with ARCI and NFC, Hyderabad. Clad-tubes with 6.60 mm outer diameter, 0.45 mm wall thickness and 1800 mm length were successfully produced. This development enables increasing the burn-up of fuel and thus reducing the fuel cycle cost.

The yttria particles with an average size of about 5nm and body centred cubic structure, that are responsible for enhancement

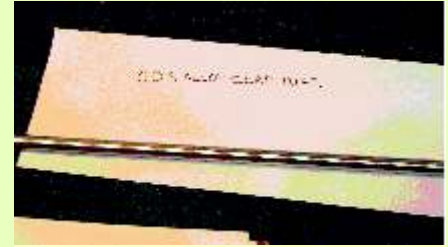

ODS clad tube

of creep strength were found to be uniformly distributed in a martensite matrix.

Boron added modified 9Cr-1Mo steel was developed in collaboration with MIDHANI to improve creep strength of modified 9Cr-1Mo steel weldment, which is susceptible to cracking at high temperature and stress. Addition of boron improves the strength of inter critical heat affected zone and reduces strength gradient across the weldment. Creep test conducted at 650°C and 65MPa showed 3.2-time increase in creep rupture life. These studies concluded that controlled addition of boron along with control of nitrogen content steel can enhance the life of the component made from this steel.

A-TIG welding process that requires only a single pass as against multiple passes for conventional welding method, was developed. This method is superior in minimising undesirable tensile residual stresses. This was demonstrated by using a specially developed ultrasonic technique

Effects of long term (up to 20,000 h) ageing at 370°C on the fracture toughness and fatigue crack growth behaviour of SS



# Nuclear Power Programme: Stage II



*Safety clearance obtained for the new welding line*

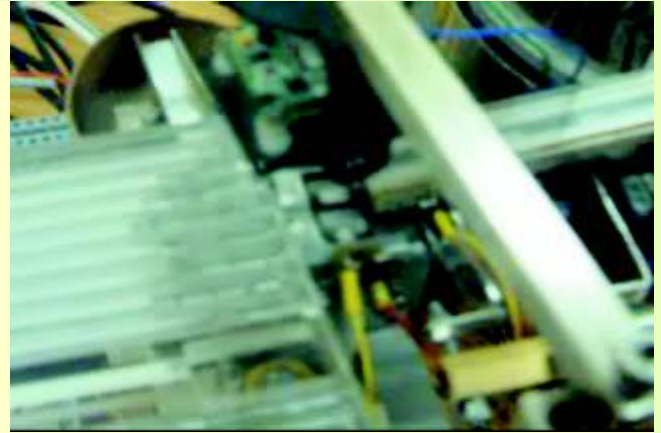

*Visual Inspection & Pellet Sorting System for PFBR Pellets*

316N weld made with indigenously developed consumables, was characterized at room temperature and service temperatures of the SS 316LN components of PFBR for use in the structural integrity evaluation of these components.

Modelling studies on miniature specimen testing procedures were made for in-depth understanding the deformation processes and optimisation of test procedures for quantitative evaluation of mechanical properties.

At BARC, the experimental (U-30%Pu) MOX fuel of PFBR enriched with U-233 has seen a burnup exceeding 92,000 MWD/T (megawatt day per tonne) against the designed burnup of 100,000 MWD/T. The landmark of fabricating 1000th MOX fuel pin for the first core of PFBR was achieved. Fabrication of Axial blanket DDUO<sub>2</sub> pellets (6 million pellets) for the first core of PFBR was completed. Safety clearance was obtained for the

new welding line for PFBR. A new Pellet sorter cum visual inspection system was undergoing UO<sub>2</sub> trials in the glove box train.

A total of seven sub-assemblies worth FBTR Mark-I (Pu, U) C fuel pins were dispatched to IGCAR. This included fuel pins made using plutonium obtained from reprocessed FBTR fuel for one subassembly, marking the fuel

cycle closure of liquid metal cooled fast reactor fuel cycle in the country. All necessary inspection and quality control procedures were carried out satisfactorily before dispatch of the fuel. The fabrication of Mark-I fuel continued to meet the further demands of FBTR.

As part of the metallic fuel development programme,

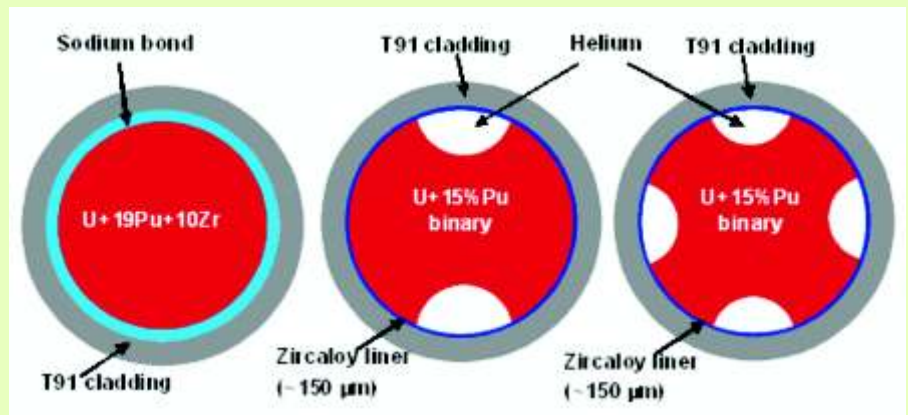

*Smear Density: 70%*

*Smear Density: 85%*

*Smear Density: 75%*

*Proposed designs for ternary and binary metallic fuels for fast reactor (Conceptual)*

# Nuclear Power Programme: Stage II

extensive out of pile studies were carried out to study the chemical compatibility, stability of fuel & clad components to support various new designs proposed for different smear densities for achieving various burn ups and breeding ratio. A new thermo physical property evaluation laboratory was set up for handling 'Pu' bearing metallic fuel materials.

Engineering consultants were appointed by BARC, for an industrial scale fuel fabrication plant at Fast Reactor Fuel Cycle Facility (FRFCF) at Kalpakkam. A preliminary project report of the Fuel Fabrication plant at co-located AHWR Fuel Cycle Facility was prepared.

10 Metre long PFBR Periscope designed & shop drawings prepared, were approved.

## FBR FRONT END FUEL CYCLE

### Fuel and Control Rod Materials

Metallic alloys will serve as fuel for future fast reactors. Towards fabrication of sodium bonded metallic test fuel pins, a glove box train facility was installed & tested. Trial fabrication of simulated sodium bonded test fuel pin with U-Zr slug was completed.

In the laboratory scale facility for test fuel pin fabrication through sol-gel process, the equipments were installed inside the glove boxes for fuel pin loading, vibrocompaction and end



*Glove box facility for fabrication of sodium bonded metallic test fuel pins*

cap welding. A sphere-pac fuel pin with two fractions of urania microspheres was fabricated and the end plug welds were found to be of good quality. The instrumentation for fuel pin scanner was developed and integrated with a customized scanning assembly & standard commercial detector electronics.

### *Impact of operating ABEP in Cascade Mode*

The Augmented Boron Enrichment Plant (ABEP) was commissioned to develop technology for the production of enriched boron of 91% in 10B using ion-exchange chromatographic process to meet the requirements of control rod material for FBTR. ABEP was charged with 50-60% enriched

boric acid in 10B to operate in cascade mode. 1.5 kg of enriched Boron with the target level of 91% was obtained after 18 months of operation. Thus a technology was developed and demonstrated indigenously for the production of 91% enriched boron using chromatography process.

A laser mass spectrometric (L-MS) facility was developed using a home-built reflectron time-of-flight mass spectrometer (RTOFMS) housed inside a glove box to analyse the isotopic ratio  $^{10}\text{B}/^{11}\text{B}$  present in the irradiated  $\text{B}_4\text{C}$  pellets of the FBTR control rod. Five irradiated  $\text{B}_4\text{C}$  pellets, from a FBTR control rod were subjected to measurement of  $^{10}\text{B}/^{11}\text{B}$  isotope ratios.

At Trombay, Duplex Swaging Machine for making grooves on



# Nuclear Power Programme: Stage II

fuel rod and for cladding to get mechanical bond was commissioned. Fabrication of glove box for the same was initiated. A small horizontal continuous casting set up was fabricated to cast grooved metallic fuel. Initial trial with uranium was taken up to understand the solidification behaviour during this process. This process will lead to reduced alpha waste generation during FBR fuel fabrication.

## FBR BACK END FUEL CYCLE

The engineering scale demonstration facility for pyroprocess studies was in an advanced stage of commissioning. A system for distillation of salt and cadmium for the recovery of actinides was tested with distillation of salt and cadmium. Electrochemical studies were carried out on the anodic dissolution of U-10 wt.% Zr alloy as well as the reduction behaviour of  $\text{LaCl}_3$  in LiCl-KCl using various electrochemical techniques.

A process for the recovery of minor actinides, along with trivalent lanthanides was demonstrated.

Rapid, high performance separation methods developed for individual separation of lanthanides and actinides were employed to estimate U, Pu and lanthanide fission products in the dissolver solution of nuclear reactor fuel.

A supercritical Fluid Extraction technique was demonstrated for the recovery of plutonium present in the cellulosic waste matrix using carbon dioxide modified with CMPO.

A pyrohydrolysis apparatus was set up for determination of chloride and fluoride and used to analyse uranium oxide microspheres obtained from the sol-gel method and boron carbide samples.

Towards development of single-phase monazite waste forms for the immobilization of high-level radioactive waste, the monazite ( $\text{CePO}_4$ ) phase and its solid solutions with up to 30 wt% of a simulated high level waste composition were prepared by a solution chemistry route.

## *Compact Reprocessing facility for Advanced fuels in Lead cells (CORAL)*

The spent fuel subassembly from FBTR with a burnup of 155 GWd/t was reprocessed and the fissile material was re-fabricated as fuel and loaded back into the reactor. This marked the successful closing of the fast reactor fuel cycle. Neutron assaying in a highly intensive CORAL hot cell was carried out successfully. The direct spectrophotometric methods were deployed for estimating the concentrations of plutonium in the plant solutions. The hydrazine carbonate process was successfully deployed for spent solvent treatment thereby reducing the solvent waste



*Demonstration facility for bulk scale pyroprocess studies*



## Nuclear Power Programme: Stage II



*CORAL Facility*

The cobalt di-carbonyl and polyethylene glycol-400 process is used for selective extraction of Cs and Sr from waste radioactive solutions. Reversed TALSPEAK process uses di-2-ethyl hexyl phosphoric acid in dodecane with TBP as phase modifier. Both the processes use task-specific stripping agents for back extraction of designated components.

### *Development of a Prototype Crystalliser for Bulk Uranium Isolation Studies*

For bulk recovery of uranium from spent nuclear fuels by crystallization method, a prototype crystallizer was developed. As the data base used in all the concurrent studies world wide was based on the classical data generated in early 1950s, a need was felt to generate new data on the solubility limits of uranyl nitrate hexa-hydrate in aqueous and nitric acid solutions with varying temperatures. This in-house generated data differed significantly from the literature data. Based on the generated data, crystallization runs were taken for several combinations of uranyl nitrate concentrations and nitric acid concentrations and bulk recovery of uranium was tried by crystallization route. In these runs, recoveries were typically more than 60% and in few cases even exceeded 90%. Thus, if this route is employed for bulk uranium recovery, load on conventional

volumes. Estimation of Pu by gamma scanning was used for the Pu content in the hulls of 155 GWd/t burnup fuel. Thus CORAL continued to provide valuable data for the design of future fast reactor fuel reprocessing plants.

### **Demonstration Fast Reactor Reprocessing Plant (DFRP)**

Vital process equipment such as chopper, dissolver, and centrifugal contactors for the spent fuel reprocessing of FBTR fuel in DFRP were in advanced stage of fabrication. Piping works were in various stages of installation.

### **R&D for Reprocessing**

Mediated Electrochemical Oxidation (MEO) process was employed to destroy the

radioactive organic wastes safely without polluting the atmosphere compared to the conventional method of disposal of organic wastes by incineration.

### **Physical properties of Post-PUREX Solvents**

After recovering U, Pu, Np and Tc from spent nuclear fuel by PUREX process, a highly active waste stream has traces of U, Pu, Zr, heat-emitters like Cs and Sr, trivalent actinides (Am, Cm) and trivalent rare-earths and all rest fission products. However PUREX process in its new variant--Advanced PUREX, has enough potential for isolation of Np, Pu (either co-stripping of Np and Pu or selective stripping) and Tc in a single-process cycle based on highly efficient centrifugal extractors.

# Nuclear Power Programme: Stage II

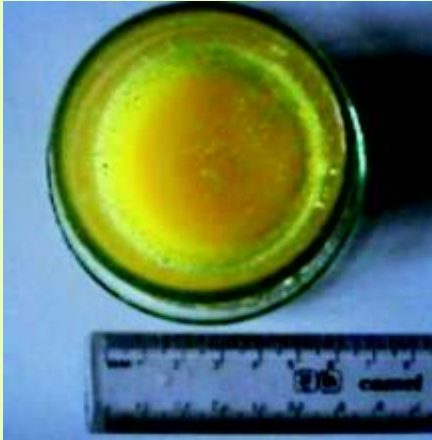

*Crystallised product of Uranium by PUREX process*

solvent extraction cycles, based on PUREX process, could be reduced to the tune of approx. 60%. Crystallization based separation forms an important part of advanced PUREX process.

## **Materials for Reprocessing Technology**

Studies carried out up to 7770 h of exposure of 304L steel used as structural materials for reprocessing applications indicated the superiority of the nitric acid grade steel produced in collaboration with MIDHANI that showed lower corrosion rate. A solid-state explosive cladding welding process was developed and used successfully to weld Ti-5Ta-1.8Nb alloy to 304L austenitic stainless steel to prevent the formation of undesirable brittle intermetallic phases at the interface which otherwise form in fusion welding processes.

## **Fast Reactor Fuel Cycle Facility (FRFCF)**

Approval of AERB for the site was obtained in Aug 2006. Geotechnical investigations, hydro-geological studies and estimation of design basis flood level were completed. Basic infrastructure was created at the site to reduce the lead time required to commence the construction work once the FRFCF project is sanctioned. Review of the preliminary safety analysis report by Project Design Safety Committee for FRFCF and specialist working groups made further progress. Consultants were appointed to carry out preliminary design of conventional systems and assist in preparing cost estimates for the detailed project report.

## **Repair & Inspection Technologies and Robotics**

### ***Helium Leak Testing of Main Vessel of PFBR***

Main vessel of PFBR is a large cylindrical vessel of outer diameter 12.90m with a dished end of special shape at the bottom. The total height of the vessel is 12.79 meter and the total surface area of vessel computes to 600 sq m approximately. Helium leak testing of entire surface of main vessel of the 500 MWe PFBR was carried out as part of regulatory requirement. As the vessel is open at the top, it is not possible to test the component using pressure method. In view of above, it was decided to perform Helium Leak Testing of entire surface using jacket/vacuum box method. The



*Fast Reactor Fuel Cycle Facility Workshop*

# Nuclear Power Programme: Stage II

entire surface was successfully with a sensitivity better than  $10^{-6}$  Pa m<sup>3</sup>/sec.

## **Quality Audit of Outer Shell Weld of SG of PFBR by Phased Array Ultrasonic & Testing**

Nine steam generators are being fabricated for the 500 MWe FBR at M/s L&T Mumbai for PFBR. The outer shell welds of the steam generator are inspected using conventional pulse echo

technique. As part of quality audit and to enhance the reliability of inspection phased array ultrasonic testing was successfully used for the examination of thick butt welds in outer shell of steam generator.

This is the first time an advanced UT technique was successfully applied during manufacture of nuclear component in DAE. More than 6m of weld were examined successfully.

## **Neutron Flux Monitoring System**

Design, development, fabrication and testing of prototype neutron flux monitoring system comprising quad preamplifier, Wide Range Pulse and Campbell channels for the Prototype Fast Breeder Reactor (PFBR) were completed.

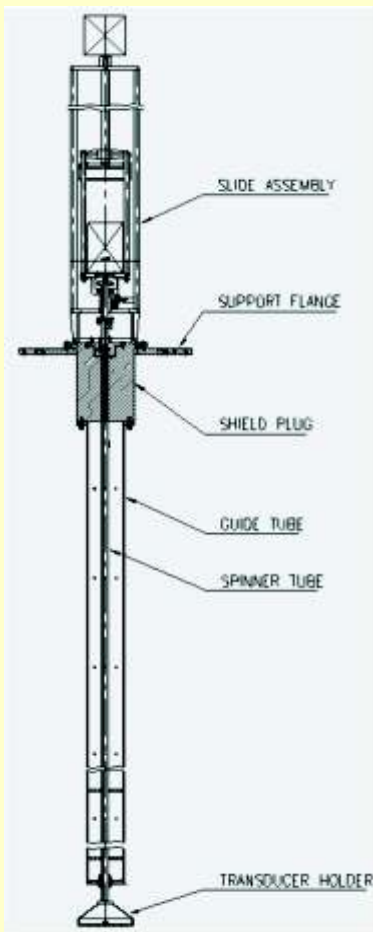

*Under Sodium Ultrasonic Scanner*



*New welding line*

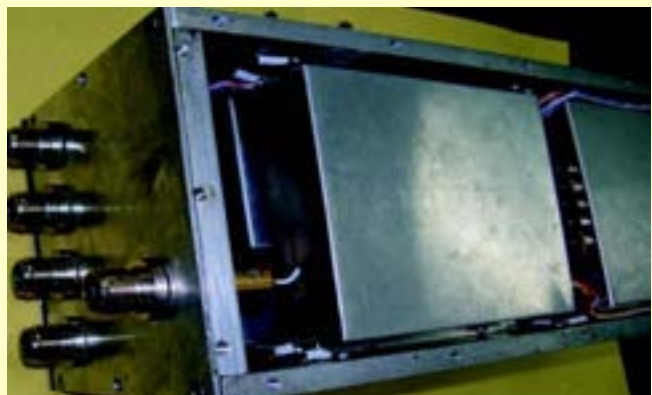

*Visual Inspection & Pellet Sorting System for PFBR Pellets*





# Chapter : 3

## Nuclear Power Programme : Stage-III

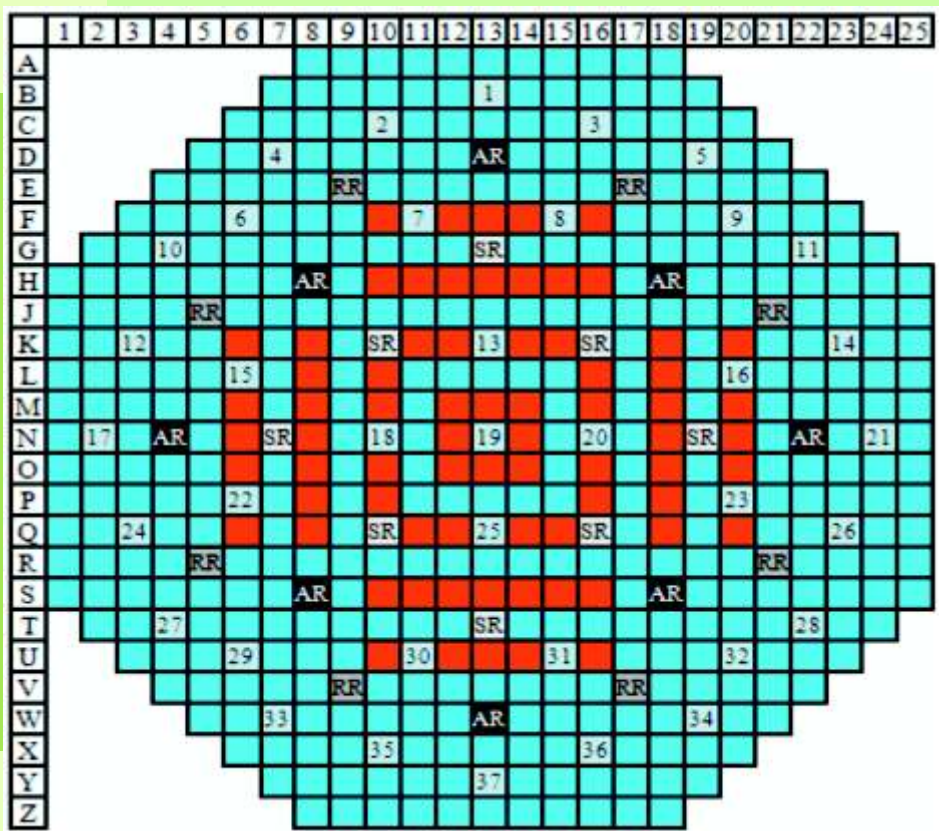

*Initial core configuration of Advanced Heavy Water Reactor  
with (U,Pu)MOX and (Th,Pu)MOX*

# Nuclear Power Programme: Stage III

## ADVANCED HEAVY WATER REACTOR

The site evaluation report for a candidate site was completed by AHWR Plant Siting Committee (APSC) of BARC. Shielding experiments were carried out in a 2x2 channel model of end shield at Apsara Reactor shielding corner to validate the End Shield design along with cross-section library and modelling procedures used.

A facility to carry out the handling of experimental fuel clusters was fabricated and set up at the Critical Facility, Trombay. Reliability analysis of Passive Containment Cooling System (PCCS) of AHWR was carried out using computer code APSRA developed in-house. The PCCS performance for a 200% break condition was analysed.

Setting up of AHWR Thermal-Hydraulic Test Facility (ATTF) continued at R&D Center, Tarapur, in collaboration with NPCIL as a part of Integrated Test Facility Tarapur (ITFT) to carry out experimental investigations on Critical Heat Flux and Parallel Channel Instability. Passive

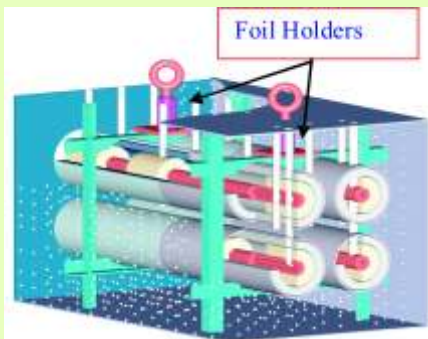

Shield Model with 2x2 Channels

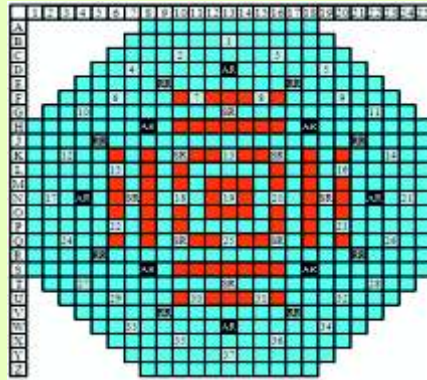

Initial core configuration of AHWR with (U,Pu)MOX and (Th,Pu)MOX

Decay Heat Removal by Isolation Condenser was simulated in Integral Test Loop and its performance was evaluated experimentally.

The equilibrium core fuel assembly was optimised with the uranium generated in-situ in the initial phases of AHWR while satisfying all the safety requirements. An alternate fuel cluster was designed to achieve the self sustenance in U-233. The AHWR core configuration was constituted by loading the outer 228 channels with alternate clusters and inner 224 channel by standard clusters. This core meets all the safety requirements and self sustenance in U-233 is achieved. However, the annual plutonium requirement goes up by 40% and the average discharge burnup reduces by 6.5%. An optimised initial core of AHWR was worked out with a minimum plutonium inventory of 460 kg. This core consisting of (U,Pu)MOX and (Th,Pu)MOX was followed up to its equilibrium state. The fuel management

scheme was evolved by loading composite clusters at about 1600 full power days (FPDs) and equilibrium was achieved at about 4500 FPD. All safety parameters were evaluated at the intermediate stages. The fuel cycle studies during the transition from initial to equilibrium core were conducted to assess the amount of U-233 and Pu produced. Pu discharged from the initial phases of AHWR had about 50% fissile. It was shown that this Pu could be used even in the core of FBRs.

A variant of the AHWR using Th-LEU fuel was studied. The equilibrium core studies were conducted. For a U-235 content of 4.13%, the core averaged discharge burnup was about 64 GWd/T. This fuel showed good fuel cycle characteristics as compared to modern LWRs and was suited to run in a once-through mode. Annual fuel material requirements were



Non-destructive testing of the fuel inside the hot cell



# Nuclear Power Programme: Stage III

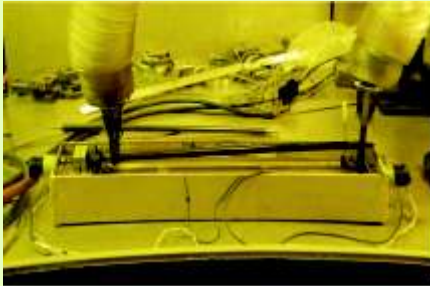

*Integrity of the fuel cladding is being ensured using eddy current tests (left) and ultrasonic tests*



*Puncture chamber kept inside the hot cell with fuel pin loaded for fission gas analysis*



*Analysis system with the gas chromatograph and the quadrupole mass spectrometer kept in the operating area of the hot cell*

calculated and compared with modern LWRs.

A fuel cluster, AC-6, consisting of five Zircaloy-2 clad short length fuel pins containing the mixed oxide pellets of

composition 96% ThO<sub>2</sub> and 4% PuO<sub>2</sub> was irradiated in the pressurized water loop of CIRUS at a heat rating of 40kW/m to a burn up of 21,000 MWd/tM. After carrying out various non-

destructive examinations, the elements tested for leaks by liquid nitrogen-alcohol method indicated that the pins were in good condition and had withstood the irradiation well.

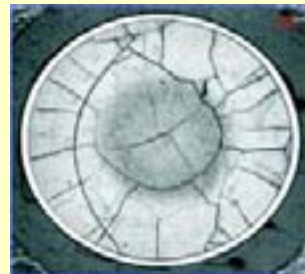
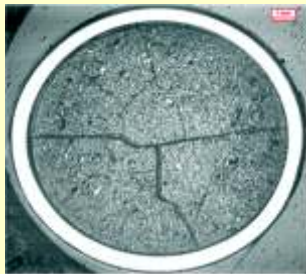

**Macro structure**

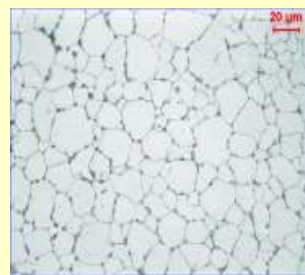
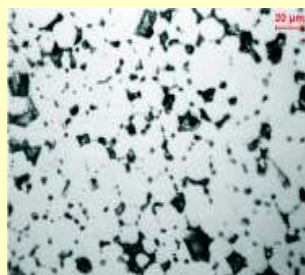
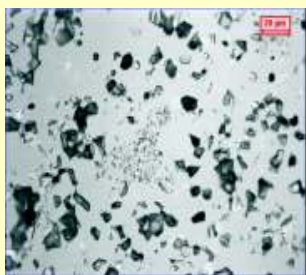

**Micro structure**

*ThO<sub>2</sub>+4% PuO<sub>2</sub> fuel irradiated to 21,000 MWd/t. Fission gas release 0.5% to 0% ; Fuel central temperature <1200°C*

*UO<sub>2</sub>+4% PuO<sub>2</sub> fuel irradiated to 16,000 MWd/t Fission gas release 8% to 1% Fuel central temperature ~1400°C*

*Natural UO<sub>2</sub> fuel of PHWR irradiated to 15,000 MWd/t Fission gas release 20% to 1%; Fuel central temperature ~1600°C*

# Nuclear Power Programme: Stage III

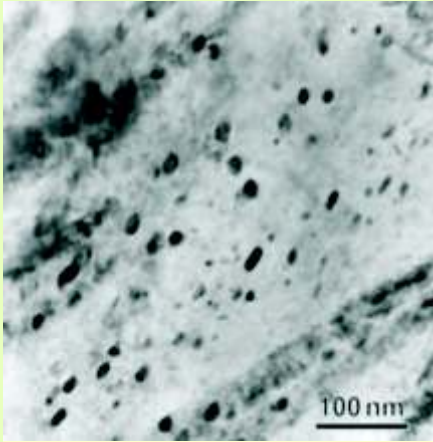

*TEM micrograph of Zr-2.5Nb alloy showing martensitic  $\beta$ -Zr laths. Very fine rod shaped  $\beta$ -Nb precipitates (dark contrast) of size less than 50 nm can be seen in this micrograph. The alloy was in Water quenched + cold rolled + aged condition.*

The microstructures of  $\text{ThO}_2$ -4% $\text{PuO}_2$  fuel was compared with that of the conventional  $\text{UO}_2$ -4%  $\text{PuO}_2$  and natural  $\text{UO}_2$  fuels irradiated to similar burn ups. The macrostructures of the irradiated fuels and the corresponding microstructure of the central region of the fuel are shown in the figure. Fabrication of  $(\text{Th-Pu})\text{O}_2$

MOX fuel pins for experimental irradiation in DHRUVA was completed. Two compaction presses were installed in AHWR installation line and are under  $\text{UO}_2$  trials.

Fabrication flow-sheet for manufacture of water quenched and aged Zr-2.5Nb alloy pressure tube was developed. Characterization of tensile behaviour and microstructure was carried out after various thermo-mechanical steps of this flow-sheet. Microstructural examination revealed that the process resulted in very fine rod shaped  $\beta$ -Nb precipitates with about 85% Nb within the martensitic plates, very similar to the ones reported for water quenched and aged Zr-2.5Nb alloy used as pressure tubes for RBMK and Fugen reactors.

A two cycle solvent extraction process for production of >99% pure  $\text{Dy}_2\text{O}_3$  with reference to the impurities Gd and Tb was developed. About 1 kg of  $\text{Dy}_2\text{O}_3$  was produced.

Development of coupled neutronics and thermal hydraulic

code PROMISIN to couple neutronics and thermal hydraulics codes continued. The stage-1, to couple the steady state codes, was completed. The in-house developed 3-D neutron transport code ATES3 was parallelised on BARC's ANUPAM-AJEYA system. With this, large reactor physics problems can be attempted with transport theory.

A refuelling procedure comprising of holding fuel at about 200 cm from top, for fifty minutes during refueling and then inserting at normal rate was evolved. Clad surface temperatures for this procedure were within operational limits. Manufacturing of prototype Fuelling Machine for AHWR and Hydro testing of Magazine assembly and Ram assembly has completed.

Development of two types of radial seal plug to maintain pressure boundary of coolant channel of AHWR was taken up. Metallic seal element based Plug and its seal were designed. Seal element of the seal plug was tested in high temperature and high



*Hydrotesting of Ram Housing*



*Hydrotesting of Magazine Housing*



# Nuclear Power Programme: Stage III

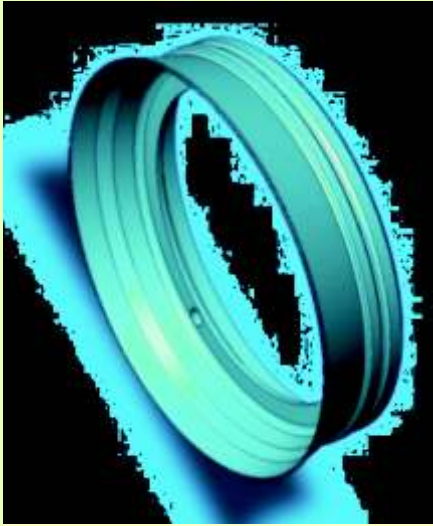

*Metallic Seal Element*

pressure condition satisfactorily. Elastomer seal element based plug was designed, prototype manufactured and tested successfully in cold condition using low temperature elastomer O-ring seal. Performance of plug mechanism was satisfactory.

Development of dissimilar material welding process for SS 304L pipe to SS 403 for Top End-fitting of AHWR was taken up. Welding Procedure Specification for Narrow gap welding technique proposed for AHWR primary heat transport piping was developed and several pipes were welded using the technique. Benefits in terms of low residual stress and lesser susceptibility to sensitization during welding were demonstrated.

At NFC, a setup, for welding of appendages on AHWR fuel tubes as requested by RED, BARC was designed and fabricated. Requisite numbers of tubes welded with appendages were



*Elastomer based seal plug*

supplied to RED, BARC for irradiation experiments.

## Thorium Fuel Cycle

Studies carried out on the ion source chemistry of Th and U using mixtures with different Th/U amount ratios using thermal



*Resistance Welding Machine for End Plugs*

ionization mass spectrometry for the accurate determination of U-232 amount in U-233 produced by neutron irradiation of Th-232.

The first fully automatic machine to weld Zirconium End caps with Zircalloy tube was assembled and delivered to user for welding trials.

Work towards the formation of “Nuclear Data Physics Centre of India” has begun.

## Other Thorium Reactor Systems

### Compact High Temperature Reactor

Solid model of Compact High Temperature Reactor (CHTR) core and general layout of reactor buildings were prepared. The design activity for the fabrication of high temperature heat pipes was largely completed. The



# Nuclear Power Programme: Stage III

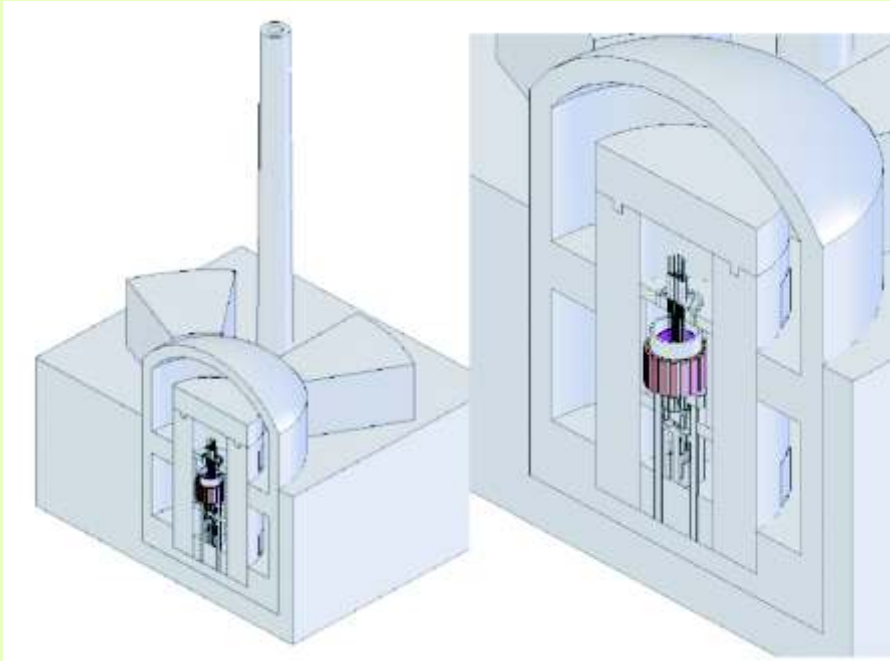

*Solid model of CHTR core and reactor building*

CHTR is being built as a technology demonstrator for the comprehensive Indian high temperature reactor programme. A new feature of Burnup Compensation Rods (BCRs) was introduced in the CHTR core and detailed physics analysis was done. The use of BCRs will help in controlling the excess reactivity

during the long reactor core life. This will in turn reduce the maximum worth of control rod during reactor operation.

## **Indian High Temperature Reactor**

The Indian High Temperature Reactor is planned for non-electrical high temperature process heat applications including production of hydrogen or secondary hydrocarbons as a substitute for primary fossil fuel. The initial core of IHTR was designed by reducing enrichment. In this configuration U-233 requirement is reduced from 7.3% to 4.25% keeping packing fraction same as 8.6%. Reactivity control and shutdown devices were designed for the initial core of IHTR.

Online determination of each

coating thickness in terms of overall size of the TRISO coated particle by a novel technique called pressure fluctuation analysis were also carried out. Multilayer coating was done on spherical zirconia particle (size 500 micron, density 6.3 kg/cum) using high temperature spouted bed. Two potential chlorine-free precursors of silicon carbide, 2,4,6-trimethyl-2,4,6-trisilaheptane and 2,4,6-trisilacyclohexane were synthesized on the lab scale.

## **Accelerator Driven Sub-critical system**

Mechanical design of the critical systems, like Micro-wave Ion source, its Beam diagnostic chamber and Beam Dump chamber for the Electron Cyclotron Resonance (ECR) Micro-wave Ion Source for delivering 50 mA Proton beam at a voltage of 50 KV was carried out. Development of various processes & techniques for the Calandria for Sub-Critical Facility of Accelerator Driven Sub-Critical System was carried out successfully.

## **Materials**

Starting from indigenously prepared molybdenum powder, process parameters were optimized to produce small length TZM alloy tubes and rods and for the preparation of other molybdenum base alloys such as Mo-30W, TZC etc. The two other techniques namely (a) component

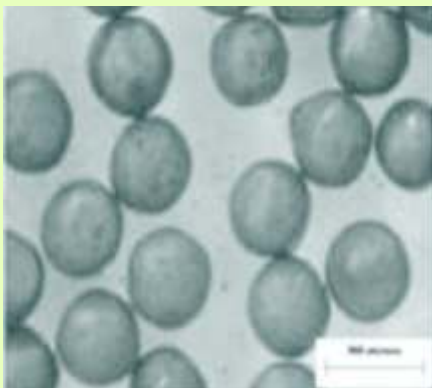

*TRISO coated particles obtained in a single batch*

# Nuclear Power Programme: Stage III

melting, and (b) co-reduction of mixed oxides followed by arc melting were explored for preparation of Nb-1Zr-0.1C and Nb-Hf-Ti alloys yielded promising results with respect to recovery and alloy chemistry.

Silicide and aluminide coatings were prepared on Nb-1Zr-0.1C alloy to improve its oxidation and resistance at high temperatures. Cobalt pellets of size 1 mm X 1 mm were produced in a multicavity die designed and fabricated in-house. Hot deformation behaviour of the sintered cobalt was studied in the temperature range from 600 to 1200°C. The samples were deformed upto a maximum strain rate of 100/sec. Detailed deformation processing map was prepared and validated by conducting hot swaging experiments. The X-Plan project on “Materials for Energy Conversion and Storage” was successfully completed as per the schedule. A prototype device was developed for storing and releasing hydrogen and deuterium.

As a forerunner to the development of cathode supported tubular cell design of Solid Oxide Fuel Cell (SOFC), YSZ electrolyte supported single cells with cathode functional layer were fabricated and characterized under oxygen and hydrogen atmospheres to evaluate the sealing and electrical contacts. A process flow-sheet was developed for hydrothermal synthesis of nanometer size sinter active YSZ

powder (avg. size 7 nm) in batch size of 150g for fuel cell electrolyte.

## Hydrogen Energy

Experimental and theoretical works of Iodine-Sulphur process continued. Structure design for the parabola dish was completed and analysed for field conditions. The reflector mirror surface was designed and developed along with its backup substrate of light weight composite materials. Development of Thermo-Chemical Reactor for dissociation of  $\text{SO}_3$  to  $\text{SO}_2 + \text{O}_2$ , to be located in the Receiver of solar collector continued.

A sol-gel method based on internal gelation, on laboratory scale, was developed for the fabrication of 500  $\mu\text{m}$   $\text{Li}_2\text{TiO}_3$  pebbles to be used for tritium breeding in International Thermonuclear Experimental Reactor (ITER).

Conceptual design for the Tritium Extraction System (TES) was proposed and approval

obtained from the International TBM port management group.

A novel process based on solid liquid combustion synthesis was developed to produce  $\text{Li}_2\text{TiO}_3$  based ceramic powder using  $\text{LiNO}_3$  and meta-titanic acid as starting raw materials. The process yielded phase pure  $\text{Li}_2\text{TiO}_3$  powder without any subsequent calcination step.

All the unit operations were revamped and 75kg of ammonium beryllium fluoride was produced from crude beryllium hydroxide. Reduction operations were conducted in a larger revamped facility and 4.36 kg of beryllium pebbles were produced.

Design Basis Report was prepared for crushing & grinding of Beryl Ore at the proposed beryllia plant coming up at Vizag. Metal Beryllium/Beryllide pebbles are used as neutron multiplying material in a fusion reactor blanket in the ITER. A rotating electrode process (REP) was developed to prepare Be pebbles of uniform size in particle diameter, high in purity and



(a) 25-cell module assembly for the skid mounted Hydrogen Generator  
Plant current density - 5000 Amp/m<sup>2</sup> (b) porous nickel electrodes

# Nuclear Power Programme: Stage III



Sintered lithium titanate pebbles

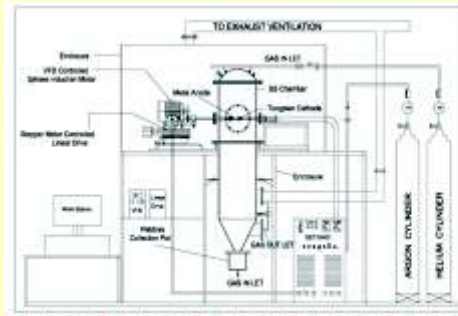

REP set up for Beryllium pebbles



Beryllium pebbles prepared by REP

sphericity. Several trial runs were carried out to validate its feasibility for preparing Beryllium pebbles. Spherical Be pebbles of average size 1.3mm were prepared by REP experimental set up. Figure shows the Beryllium pebbles obtained to be nearly spherical with less oxidation of average size 1.3 mm. The density of the Be pebbles obtained was 1.84 gm/cc.

Hydraulically automated filter compaction machine was fabricated, installed and commissioned for denting and compaction of spent High Efficiency Particulate Air (HEPA filter) to one fifth of its original volume. This machine has capacity to compact and contain six numbers of filters in a batch.

A novel all ceramic type single compound of  $\text{BeO-Li}_2\text{TiO}_3$  as an alternate for beryllium- lithium titanate ( $\text{Be-Li}_2\text{TiO}_3$ ) to be used as neutron multiplier and breeder material for ITER, was synthesized

Lithium titanate was synthesized using two different routes namely sol-gel and solid-state reaction routes.

Carbon fiber-carbon matrix composites having high specific strength, stiffness and in-plane toughness with the refractory properties of structural ceramics were prepared by Chemical Vapour Infiltration. Model equations representing the rate of change of precursor ( $\text{CH}_4$ ) concentration and porosity of the preform were developed.

The carbon-carbon composite (C/C composite) were prepared using PAN fibre and phenolic resin developed through impregnation route and densified by two cycles of impregnation.

The samples were

characterized by XRD, Raman Spectroscopy and X-ray tomography.

Silicon carbide (SiC) coating on C/C composites was also carried out using methyl trichlorosilane, hydrogen and argon as carrier gas in a high temperature graphite furnace at 1673 K.



HEPA Filter Compaction Machine



# Chapter : 4

## Advanced Technologies and Radiation Technologies and their Applications



*Bead-pull measurement set-up at VECC for 5-cell  
Linear Accelerator (LINAC) cavity*

# Advanced Technologies and Radiation Technologies and their Applications

Over the years, India has made remarkable progress in the production of radioisotopes and applications of radiation technology in the areas of nuclear agriculture, food preservation and industry.

The radioisotopes are produced in research reactors at Trombay, accelerator at Kolkata and various nuclear power plants. BARC, BRIT, RRCAT and VECC are the organisations of DAE that are engaged in the development of radiation technologies and their applications in the areas of health, agriculture, industry and research.

DAE is also working in close cooperation with other organisations of the Government of India to widen the reach of these technologies for the benefit of the common man.

## RESEARCH REACTORS

### APSARA

APSARA reactor was operated at 200 kW for research in Neutron shielding experiments, Neutron Activation Analysis, Radiation damage studies and Forensic science & Irradiations. Various types of Neutron detectors were tested in Thermal column facility, Core Position and in Beam hole for performance evaluation. Reactor availability factor of 82% was achieved till the reactor was shut down.

After 52 years of excellent service and completion of all the scheduled experiments, APSARA was shut down on June 6, 2009 for

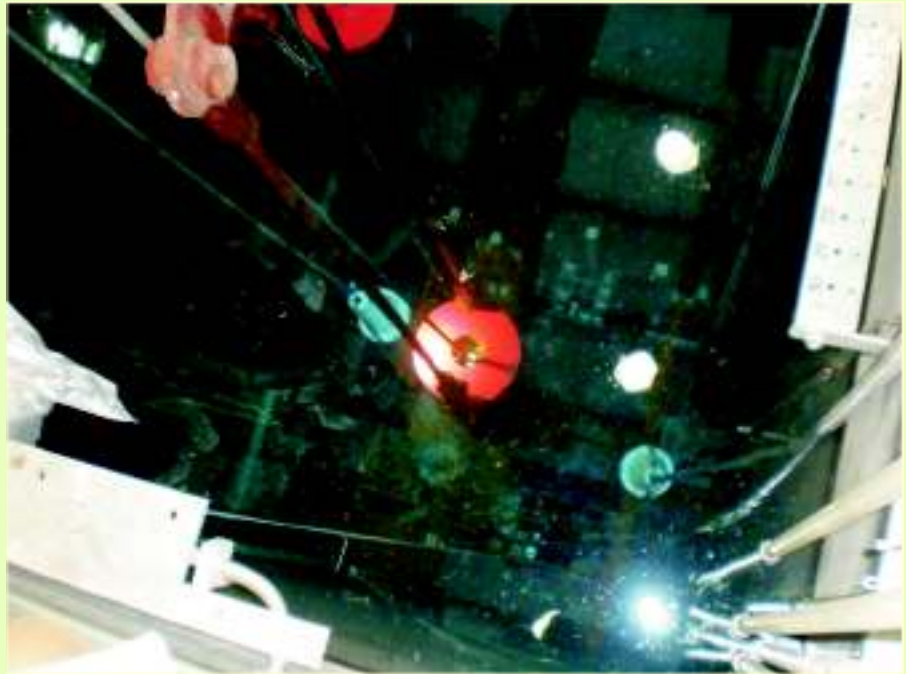

*De-fuelling of APSARA Core*

upgradation.

Work on upgradation of APSARA reactor to a 2 MW reactor continued. Basic design of the reactor core and various reactor systems was completed. The HEU fuel of the reactor will be replaced by LEU fuel and the maximum thermal neutron flux of the upgraded reactor will be  $6.5 \times 10^{13} \text{ n/sqcm/sec}$  and will provide improved facilities for beam tube research, radioisotope production, calibration & testing of neutron detectors, neutron radiography, material testing and bulk shielding experiments.

The Critical Facility for Advanced Heavy Water Reactor (AHWR) and 540 MWe PHWR was operated on 67 occasions for various experiments. Dynamic tests to measure worth of Shut-off-

rods (SORs) in various combinations were carried out at nominal power of 100W. Reactivity worths were found to be in good agreement with estimated values.

Absorber rod (AR) calibration was carried out and the results were found to match with calculations. Measured worth of absorber rod was matching with estimated value. Earlier trial operations were carried out satisfactorily at nominal power of 100 W on stipulated number of occasions. A procedure was evolved for measuring the level coefficient by observing the reactor period due to batch additions of moderator which was approved by the programme committee. Experiments for the measurement of level coefficient

# Advanced Technologies and Radiation Technologies and their Applications



*Installing sample for irradiation in bottom graphite reflector of Critical Facility*

of reactivity by supercritical positive period measurements continued. Various experiments were conducted in the Critical Facility for AHWR for the measurement of neutron spectrum on the central fuel housing tube surface by activation analysis method.

The Critical Facility was also used for nuclear detector testing and large volume sample irradiations for Neutron Activation Analysis (NAA). Testing of B-10 lined detectors for qualifying them for use in advanced special purpose reactor, newly fabricated pulse channel along with B-10 lined detector for use at Purnima neutron generator (14 Mev and 2.5 Mev fast neutrons) facility, Digital Signal Processing (DSP) based neutron

flux monitoring channel for Pulse & Campbell operation with a fission counter were carried out.

## **CIRUS**

CIRUS reactor was operated at 20 MW(th). Power was raised to higher levels as and when required. The reactor Availability Factor was 82.65%. 460 radioisotope and other samples were irradiated in various irradiation facilities. The performance of the Desalination Unit integrated with CIRUS for utilizing the waste heat was excellent and supplemented the de-mineralized water requirement of the plant. The neutron radiography setup of APSARA for imaging small size material coupons was shifted to CIRUS

and commissioned successfully. Establishing another neutron radiography setup at one of the beam holes of CIRUS, to facilitate post irradiation examination of irradiated fuel pins of power reactor, was in the process.

## **DHRUVA**

Research reactor DHRUVA continued to operate with a high level of safety and an availability factor >78%. The reactor was operated at 55 MW(th) and higher power as per the researchers requirements. Towards radioisotope production, 680 samples were irradiated during the year. Fifty four samples were irradiated in Pneumatic Carrier Facility for neutron activation analysis. DHRUVA continued to be the major facility for radioisotope production and served as a national facility for neutron beam research.

As part of up-grading the Emergency Core Cooling System (ECCS) of DHRUVA reactor, additional canned rotor pumps, heat exchangers and associated piping system were retrofitted and commissioned. In view of the redundancy in equipment and introduction of long term heat removal provisions in recirculation mode, the overall reliability and safety of the ECCS was increased thereby enhancing the safety of the reactor.

Flux mapping of beam hole HS3018 was carried out by designing a carrier assembly using 1S-Aluminium material as a part



# Advanced Technologies and Radiation Technologies and their Applications



*New Emergency Core Cooling System pumps of DHRUVA*

DHRUVA was fabricated and successfully tested in spare magazine of the fuelling machine. Subsequently, three more extractors were fabricated. Trial testing of the extractor with fuelling machine was carried out successfully.

One of the existing 150 KVA Motor Alternator sets at DHRUVA was replaced with the higher capacity 250 KVAMA sets. The replaced version of the MA set uses the state-of-art controls and added safety features. Old 1000 Ampere-Hours class-1 battery bank of DHRUVA was replaced with a new 1200 AH battery bank capable of sustaining High rate Discharge. A new support frame to safeguard the battery banks from seismic loads was introduced. Large capacity Air Circuit Breakers in reactor power supply system were

of silicon irradiation programme. Existing strainers in all the three DHRUVA reactor structural cooling water loops were replaced with improved design of strainers. This has increased the net flow area available for filtration within the existing strainer housing thereby reducing the cleaning frequency of strainer element. The performance of the newly designed strainers was satisfactory and considerably reduced the Person-Sv consumption during their replacement.

Characterisation of neutron spectrum of DHRUVA beam hole was completed for the development of a neutron time-of-flight facility in DHRUVA reactor. Some of the problems in DHRUVA fuelling machine like drifting of machine at select

locations and deficiency in the parking brakes were corrected. One modified prototype extractor for use in the fuelling machine of



*Modified Extractor of Fueling Machine of Dhruva*

# Advanced Technologies and Radiation Technologies and their Applications

retrofitted with latest version ACBs which are compact and having microprocessor based protection to ensure smooth and reliable performance. Existing aluminium conductor with Heat Resistant Poly Vinyl Chloride insulated power cables of all 3.3 kV motors were replaced with Cross Linked Poly Ethylene insulated copper conductor cables for trouble free performance and enhanced reliability of coolant system pumping equipment. Activities pertaining to replacement of the process water/seawater heat exchangers, relocation and up gradation of spent fuel storage bay water purification system and up gradation of various control and instrumentations related to reactor trip logic system, coolant flow monitoring system, emergency core cooling system & alarm annunciation system were in progress. A Fire Alarm Data Acquisition System for DHRUVA Reactor was developed. This is an industrial PC based system which can cater to 300 detectors of different types including ionization type smoke detectors, photo-electric type detectors, heat detectors and flame detectors.

During the year, 196 metallic fuel assemblies to DHRUVA, 111 fuel assemblies to CIRUS and more than 1500 subassemblies and other core components were fabricated and supplied. Development of on-line beta heat treatment process of rolled/extruded DHRUVA fuel rod made progress. A hot swaging

machine was installed and commissioned to reduce the diameter of extruded DHRUVA fuel rod such that one stage of centreless bar turning operation can be avoided. It will result in reduction of uranium chips and increase in yield.

Development activities were initiated to fabricate U-Mo monolithic fuel plate. Pack rolling technique was employed to achieve Zr lined U-Mo plate. Optimisation of parameters and production evaluation was in progress. For Al cladding all around, friction stir welding work was initiated.

The conceptual design of a high flux Multi-Purpose Research Reactor (MPRR) for high specific activity radioisotopes and to provide enhanced facilities for basic research and for applied research related to development and testing of nuclear fuel and reactor materials was carried out. The core configuration was modified to enable operation of the reactor as a critical core and as an ADS driven sub-critical core. Feasibility study for incorporation of an external spallation neutron source in the MPRR core, so as to operate the reactor as an accelerator driven sub-critical reactor system in future, progressed.

Support was provided to NPCIL in modifying ion exchange scheme for selective removal of gadolinium nitrate in presence of boron. Expert analytical and technical support was provided to HWB and NPCIL in the

preparation of reference standards for the isotopic analysis of high purity reactor grade heavy water. Level 1 Probabilistic Safety Assessment of CIRUS reactor based essentially on plant specific data was completed. Second cycle of in-service inspection of CIRUS and DHRUVA reactors was continued and about 2000 components belonging to various systems of CIRUS and DHRUVA were inspected by different NDT methods. Services were provided for the assessment of structural integrity of piping, supports and equipment of Radioactive Solid Waste Incinerator plant prior to its restarting and for inspecting internals of two high temperature chemical reactors. A programme for life and reliability prediction of engineering components was initiated.

## ACCELERATORS

At BARC, machining and vacuum brazing work on the LINAC Cavities for 10 MeV R.F Electron Structure consisting of 33 copper cell cavities, 5 SS flanges and 1 Wave guide carried out. Manufacturing of compact water cooled slit assembly for Photo-emission Electron Microscopy/Angle Resolved Photoelectron Spectroscopy (ARPES) Beamline for INDUS-II was taken up. Experimental station for Small Angle X-ray Scattering/ Wide Angle X-ray Scattering (SAXS/WAXS) beamline was designed to study small and wide angle scattering of



# Advanced Technologies and Radiation Technologies and their Applications



*Radioactive Ion Beam Facility at VECC, Kolkata*

Complex was completed. The safety analysis report was prepared and AERB was approached for stage-2 approval.

## ***Development of high power RF components***

Solid state amplifiers with RF components like 8-way power divider/combiner, 16-way power divider/combiner, low and high power directional couplers and high power 2-way combiner were developed. These operate at the RF frequencies of 352 MHz and 505.8 MHz for use in proton accelerator and Indus machines, respectively. The measured performance of these components was excellent and based on this experience, development work for higher power RF component was initiated.

synchrotron radiation, when passing through different types of substrates.

At VECC, the development of a low energy Radioactive Ion Beam (RIB) facility, which will deliver 1.3 MeV/A beams continued.

During the report period, VECC completed the project of Heavy Ion Experimental Facilities. As a part of Multi-cell superconducting RF Linac Cavity project, VECC fabricated copper prototype cavity, and various low-power RF testings were carried out on it. Besides these, an automated Bead-pull measurement system was developed to investigate the field profile inside the cavity, which is essential for tuning multi-cell cavity.

The plant design for construction of ARPF at Mandi



*Bead-pull measurement set-up for 5-cell LINAC cavity*



# Advanced Technologies and Radiation Technologies and their Applications



*Tested copper vapour laser units at RRCAT*



*500W average power fibre coupled pulsed Nd:YAG laser*

## **Radiation safety system laboratory**

A radiation safety system laboratory was in the process of being set-up at RRCAT with a Radiation Calibration Cell for maintenance of radiation monitors at the Indus facility. Design of the lab building with appropriate shielding was prepared and the civil work will start shortly. Process for procuring the radiation sources and the design of the calibration bench were in progress.

## **LASER TECHNOLOGY**

### ***Supply of copper vapour laser units to BARC***

RRCAT supplied 8 copper vapour laser units each of around 40 W of average laser power, to BARC for laser isotopic enrichment programme.

### ***Development of 500 W average power pulsed Nd:YAG laser***

To further enhance laser material processing capabilities a 500 W average power pulsed

Nd:YAG was recently developed by incorporating design modifications in the 250 W average power industrial Nd:YAG laser. The major challenge was in the design of a resonator with dual pumping chamber as well as optical and electrical synchronization of these two chambers. A maximum of 510 W average power with an electrical to laser power conversion efficiency of 5% was achieved.



*A view of the developed Yb-doped continuous wave fibre laser*

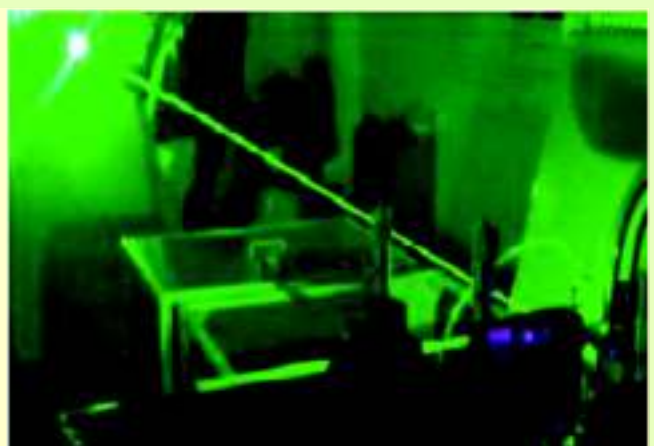

*Photograph of 50 W, 50 ns green laser*

# Advanced Technologies and Radiation Technologies and their Applications

## ***High average power green beam with short pulse duration***

A green laser of 50 W average power with 50 ns pulse duration was demonstrated in a coupled cavity configuration for pumping of dye lasers. Highly stable and nearly symmetric green pulses of 50 ns duration with 50 W of average power at 8 kHz repetition rate at a total diode pumping power of 420W was obtained. Such lasers offer an attractive alternate pump source for dye lasers which are used for laser driven selective excitation studies.

## ***Development of 40W single transverse mode CW fibre laser***

A single transverse mode CW Yb-doped fiber laser with an output power of ~ 40W and slope efficiency of ~72% was developed. Its output spectrum was peaked at 1093nm. In this development Yb-doped fiber was pumped from both the ends using fiber coupled laser diodes at 975 nm. Further efforts for power scaling to achieve 100W CW output power from single module fiber laser was under progress. This work will be useful in the development of compact single transverse mode fiber laser for various material processing applications.

## **Laser Applications**

### ***High order harmonic generation***

Experiments were carried out on converting the 793 nm laser light into its high order harmonics.



*Experimental set-up for electromagnetically induced transparency*

Various materials were used. It was found that for C60, the harmonics have a large conversion efficiency in the lower orders (~ 23-29th order). Harmonics from silver containing nano-particles also showed high harmonic conversion. With nano-particles, it was observed that under certain conditions, harmonics in the range of 9th to 19th order have an accompanying lobe in the blue side, whose size decreases with increasing order.

### ***Laser absorption with nano-targets***

Experiments were carried out on absorption and x-ray emission from 1) nano-hole alumina, 2) nano-wires of CuO, ZnO, and Fe<sub>2</sub>O<sub>3</sub>, and 3) carbon nano-tubes (CNT) coated on Mo, Cu and Au. Like the metal cluster targets, the nano-hole targets showed

resonance at certain laser pulse duration, giving an order of magnitude x-ray intensity enhancement as compared to the planar bulk targets. The nano-wire targets gave more x-ray emission than corresponding planar targets. The CNT coated targets also showed a much higher x-ray yield of K- as well as hard x-rays.

### ***Cooling and trapping of <sup>85</sup>Rb atoms***

Electromagnetically induced transparency (EIT) is reduction in absorption of a probe beam in the presence of a strong coupling laser beam resonant with a suitable transition. A new experimental scheme was demonstrated to obtain EIT with cold <sup>85</sup>Rb atoms trapped in the lower hyperfine level of the ground state. In contrast with earlier performed experiments, our methodology

# Advanced Technologies and Radiation Technologies and their Applications

enabled us to operate without periodic turning off of the trap. The steady state cold atomic sample was used to investigate the role of magnetic sublevels in the generation of EIT signal. The experimental observations were found to be in good agreement with theoretical calculations.

## ***Optical nonlinear response of metal nanoparticles***

A new time-intensity domain method of analyzing conventional transient absorption measurement data to extract the magnitudes and decay times of the imaginary parts of the third, fifth and seventh order optical nonlinearities of silver nanoplatelets in water at the SPR resonance was demonstrated. The measurements covered intensity regimes for weak and strong perturbation. The observed enhancement over the non-resonant values was  $\sim 30$ , 5000, and 7,00,000 times for the third, fifth and seventh orders respectively. The corresponding response times were  $\sim 0.9$  ps, 0.4 ps and 0.3 ps showing that the higher order nonlinearities decay much faster.

## **Biomedical applications**

### ***Tissue imaging by optical coherence tomography (OCT)***

An OCT system was developed and used for tissue imaging in various studies such as 1) imaging of resected human breast tissues to reveal important differences in the stiffness of cancerous and normal tissue, 2) to image structural

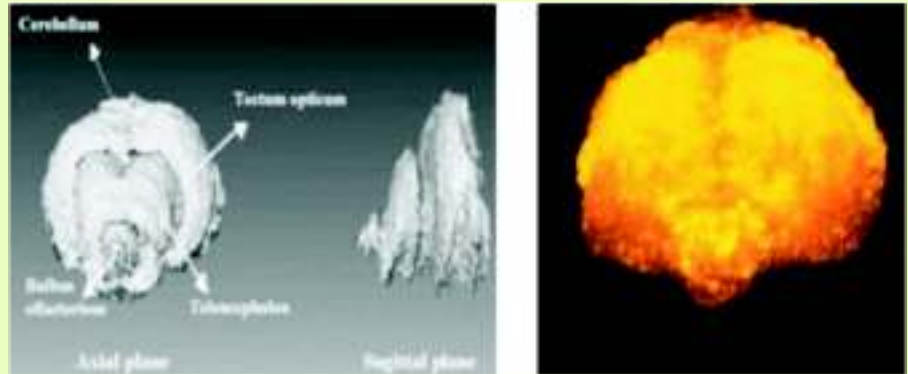

*3D Optical Coherence Tomography image of zebrafish brain*

changes during healing of the superficial wounds, and 3) to monitor changes in the hair follicle growth stimulated by laser irradiation in animal models. Also, a real time OCT system capable of acquiring 2D cross sectional images was successfully used to construct a 3D image of Zebrafish brain for study of its anatomical features non-invasively. This setup was upgraded and real-time imaging of human skin with improved resolution was demonstrated. A Fourier-domain OCT setup in combination with light microscopy was used to study structural changes in Zebrafish embryos due to ethanol exposure and various abnormalities and developmental delay in the embryos was clearly imaged. A swept source OCT setup was fully assembled and characterized.

### ***An improved technique for optical trapping of biological objects***

An improved technique using vortex beam for optical micromanipulation of biological

objects was developed which allows trapping of the objects to an extended depth inside the medium. Use of this technique was demonstrated for measurements on single cell trapped at different depths inside the medium to study changes in the biophysical properties of the cell membrane at varied oxygen levels. Studies on the use of vortex trap beam for optical manipulation of goat sperms show that for trapping sperm cells these provide better trapping efficiency and cause lower adverse effects compared to trapping with conventional optical trap.

### ***Nanoparticles for drug delivery & phototherapy applications***

Variety of silica nanoparticles were prepared and used to evaluate delivery of potential drugs such as merocycine 540 and chlorin p6 for photodynamic treatment of cancer cells. Nanoshells conjugated to antibody specific to breast cancer cells were prepared and studies carried out in cancer cells show that these nanoshells have good



# Advanced Technologies and Radiation Technologies and their Applications



*In-situ laser cutting of bellow lip in reactor and 18 mm thick shock absorber studs cut from reactor*

potential to be used for photothermal therapy as well as for imaging techniques as contrast generating agents.

## Industrial applications

Laser based cutting technique of bellow lip weld joint was deployed for cutting of 612 bellow lip weld joints. Improved design of tools and fixtures as well as optimization of laser parameters, facilitated post cutting separation of coolant channels. Removal phase of coolant channels was smoother and MANREM consumption was also reduced as compared to previous EMCCR campaigns at NAPS-1 and NAPS-2. Out of 1224 studs, a total of 78 were found jammed and using this laser technique, these studs were cut successfully during EMCCR campaign at KAPS-1.

A laser cutting technique and special fixtures were developed to cut steam generator tubes from inside its assembly in highly radioactive area (104 rad/hour). The technique was deployed for

cutting of one of the SG tubes at SG-3 location in NAPS-2 reactor, without damaging the tubes nearby, at a distance of 783 mm from the base of the tube. This laser cutting technique is inexpensive, relatively easy to implement and the MANREM dose received by the personnel is far less compared to mechanical techniques. It is a very useful technique in maintenance of power reactors and can be deployed in future for cutting of all kinds of narrow diameter tubes at different locations in PHWRs.

An Nd:YAG based laser micro-welding technique for brachytherapy assembly with a high dose rate (HDR) 10 Curie Iridium source for cancer treatment was developed for BRIT and BARC. Laser

parameters were optimized so that the complete Brachytherapy assembly can meet the standards of load test for each weld joint. The welded joints were tested to withstand strengths of 15-20 kg similar to that of parent material. Medical trials are under progress for several samples. Development of complete laser based system along with fixtures and viewing camera was in progress for commissioning at BRIT, for regular production of such brachytherapy assemblies to substitute imported assemblies.

## Laser Instrumentation

A 20W fibre laser based micro-machining system was developed for the fabrication of micro components in stainless steel. The laser and some micro machined parts respectively are shown on the following page.

A 100W fibre laser based micro-welding system was developed for the fabrication of hermetically sealed components in stainless steel.

A pulsed high power ultra violet light emitting diode (UV LED) based uranium analyser for remote operation was developed for the measurement of uranium in



*Laser welded brachytherapy assembly*

# Advanced Technologies and Radiation Technologies and their Applications



*20W fibre Laser system for micromachining*

cracks, pits and end defects. The inspection system was tested at NFC with assorted 100 samples that represented good and bad pellets. The system performance was satisfactory with 90% accuracy. The inspection cycle time was observed ~ 8-10 seconds depending on the number and type of the defects.

9 kHz Copper Vapour Laser Assembly (CVL) and a special type mobile fork Lifting Mechanism to handle these CVL assemblies was designed and detailed technical specification for its procurement is completed. A prototype of Single Longitudinal Mode (SLM) Dye Laser Assembly meeting all the requirements of the end user was developed and manufactured with extreme precision.

active samples. The system was developed for use at IGCAR, Kalpakkam.

A prototype machine vision based automated inspection system was designed and developed for quality assurance of

the cylindrical fuel pellets (12-15 mm diameter and 15-25 mm length) used in PHWR. This involves acquisition of the pellet image and digitally processing of the image to identify surface imperfections such as chips,

## **SPECIAL MATERIALS**

A new process was developed to grow cesium-iodide crystals for

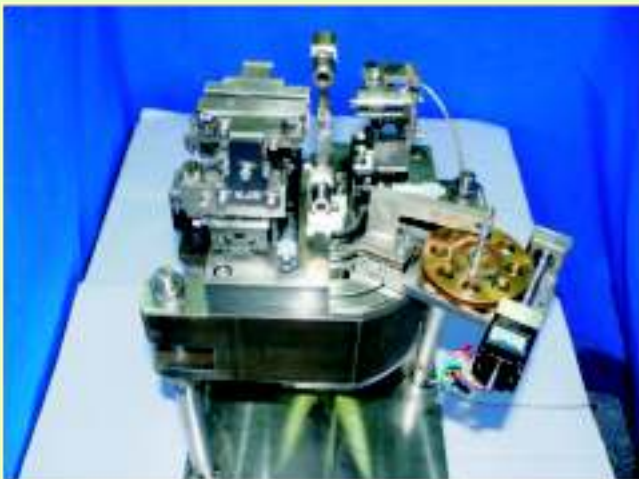

*Copper Vapour Laser Assembly*



*SLM Dye Laser Assembly*

# Advanced Technologies and Radiation Technologies and their Applications

radiation detectors. The devices made using these crystals exhibited good sensitivity to gamma rays. Good quality transparent single crystals of lithium tetra-borate ( $\text{Li}_2\text{B}_4\text{O}_7$ ) were grown using the Czochralski technique. The grown crystals doped with copper showed excellent thermo-luminescent (TL) properties suitable for radiation dosimeters.

A few compositions based on Ba-Ca-Al-B-silicate and Ba-Zn/Sr-silicate were optimized for high temperature sealant and seals were made. Detailed structural studies were completed. A conductivity probe for the development of a sensor to measure the void fraction in the Containment Studies Facility (CSF) project was designed and fabricated. Calcium borophosphate and iron doped calcium phosphor-silicate glass-ceramics were prepared by melt route and studied for biocompatibility in simulated body fluid.

A large number of modified triple filament glass-to-metal seals for thermal ionization mass



*Conductivity Probe Assembly with lead protection*

spectrometers were prepared. Glass based devices were produced as per users' requirements. Lithium titanate pebbles preparation by Solid state reaction/extrusion/spherodization process was standardized. The product conformed to the Test Blanket Materials (TBM) specification.

## ADVANCED TECHNOLOGIES

A detection technique based on

acoustic signals for steam leakage from AHWR was developed for full scale testing before deployment in AHWR. Battery powered wireless Remote Control Chair for Controlling ROHYTAM was developed. Duel Axis Servo controller card, four channel proportional valve controller card and a signal conditioning card were developed for driving electro-hydraulic linear and rotary actuators used in ROHYTAM.

A high performance electro-hydraulic servo linear actuator was developed. It works in a closed loop with model based controller algorithms.

Hydraulic balancer consisting of hydro-mechanical servo linear actuators was developed for handling and orienting the heavy loads. These actuators require very small force to move heavy loads and they get hydraulically locked to required position.

High flow control valve was designed for control of feed water flow. The flow through the valve is proportional to the input signal and remains constant under any fluctuation in pump and load

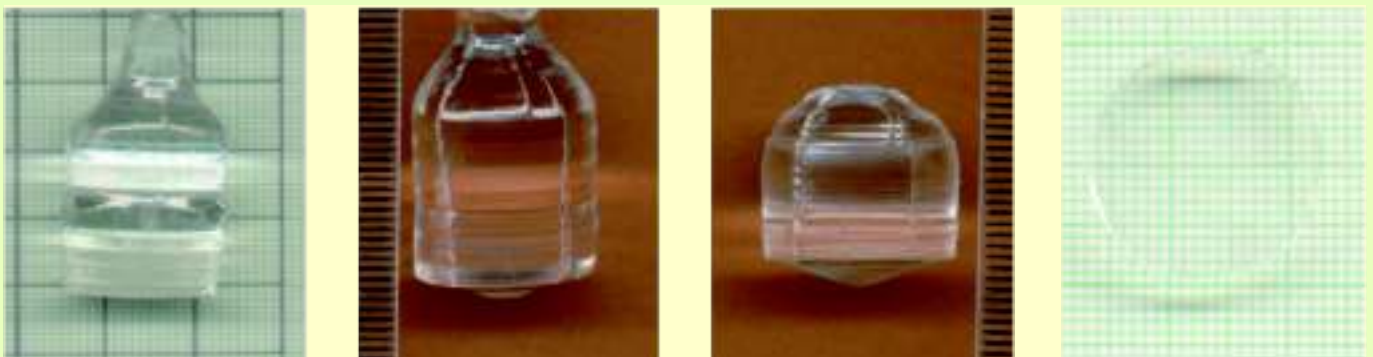

*$\text{Li}_2\text{B}_4\text{O}_7:\text{Cu}$  crystals and a polished crystal plate (Right)*



# Advanced Technologies and Radiation Technologies and their Applications

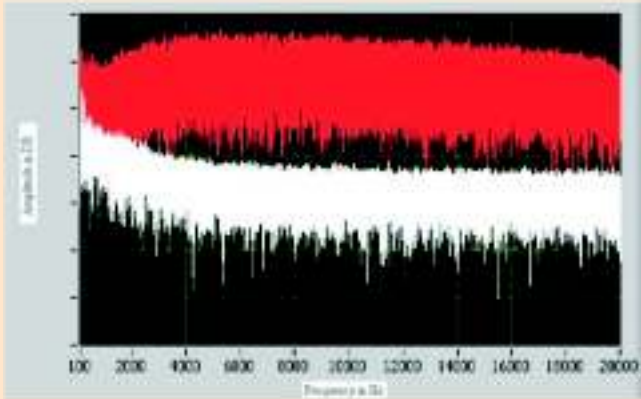

*Comparison of Background Signal (White) with steam leak Acoustic Signal (Red)*

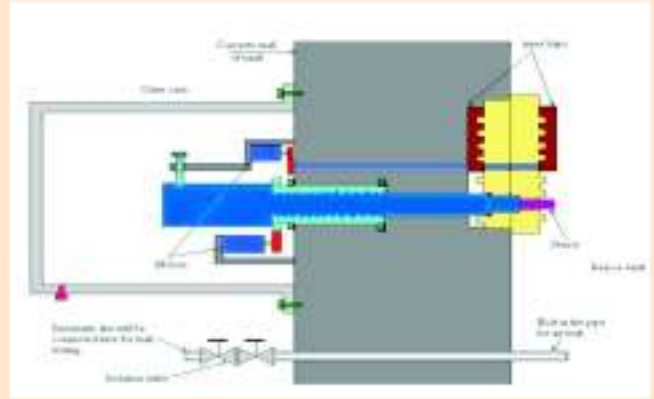

*Installation of Acoustic Sensors in the Vault*



*Wirelessly controlled ROHYTAM, Remote control chair, Dual Axis Servo controller card with RS485 interface*

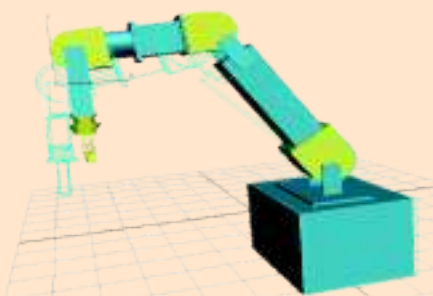

*Soft Master Manipulator  
new ROHYTAM*



*New ROHYTAM  
Servo-manipulator*



*High performance electro  
hydraulic servo linear actuator*

# Advanced Technologies and Radiation Technologies and their Applications



*Hydraulic Balancer for handling heavy loads*

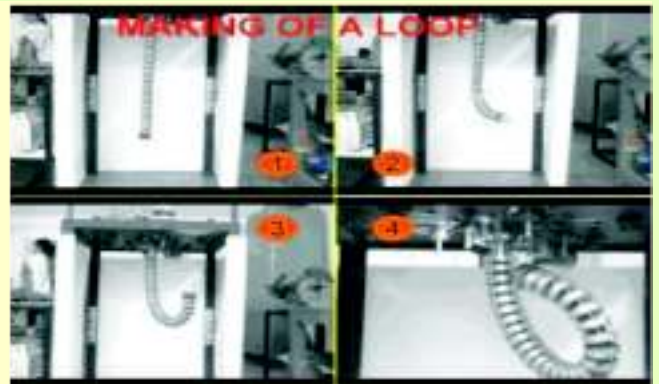

*Snake Arm Robot : 1.: Snake Arm in vertical position. 2.: Snake Arm in 'L' shape. 3.: Snake Arm in 'U' shape. 4.: Snake Arm forming a loop.*

pressure. A prototype of the valve was fabricated. Performance evaluation of various subcomponents and the prototype carried out in Integral Thermal Facility.

A prototype Snake Arm Robot of one meter length and payload capacity of 10 kg was developed.

The autonomous control and enhanced mode operation for the slave arm of the Advanced Servo Manipulator (ASM) was initiated.

Design and development of a material handling Autonomous Guided Vehicle (AGV) and its control and supervisory software was completed.

Based on MoU signed with NTPC, BARC developed an automation system for Boiler Tube Inspection. A magnetic crawler was specially developed to carry the EMAT for inspection. The system has recently been field tested at NTPC's Dadri Plant.

Design and development of Trombay Programmable Logic Controller-32 (TPLC-32) having an in-house developed high-speed 32 bit microprocessor module along with intelligent plant Interface modules and high speed communication modules was completed.

The Application Development Software (ADE) of TPLC-32 was developed as per International standard IEC 61131-3. The use of

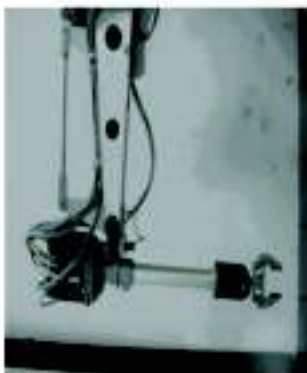

*Slave Arm of ASM*

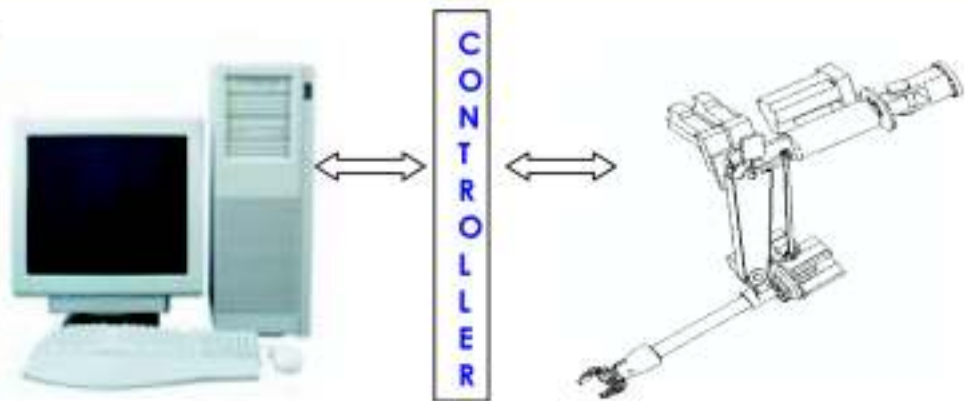

*Force Reflecting Tele-robot*

# Advanced Technologies and Radiation Technologies and their Applications



*Autonomous Guided Vehicle for automated material transfer*



*Field testing of magnetic crawler with EMAT*



*TPLC-32 System*



*Foot Step Electric Converter platform*



*Nebuliser based spray dryer system for nanomaterial synthesis*



# Advanced Technologies and Radiation Technologies and their Applications



*Cold box internal view*



*Micro Cryo-Cooler assembly*



an in-house developed Operating System ESOS in the TPLC-32 software ensures real time performance of the plant process control function.

BARC developed a Safety Partition Kernel (SParK) for nuclear reactor application. SParK is a Real-Time Kernel (core of operating system), which helps in segregating the non-critical software modules from the critical one and allows them to run in Partitions with guaranteed integrity. Such a Partition Kernel is not available in the market.

The energy transferred during walking by a person can be tapped and converted in to the useable form such as in electrical form.

A mobile platform fitted with 5 electric converter devices was developed which can be placed at any public places such as the footpaths, Shopping malls, Railway platforms etc.

As millions of people are on the move in cities, significant amount of electricity can be generated by

installing these devices at places where public walk through.

An aerosol process based spray drying system was designed and fabricated to understand the self assembly of colloids at various physicochemical and thermodynamical conditions.

Development, design and fabrication of superconductor cable insertion set up was carried out.

Subsequent to demonstration of Compact High Energy Density Closed Cycle Thermal System (CCTS) technology at 200 kW(th) power level for desired duration, a series of experiments were carried out for final stage system integration. A system for recovery of unconsumed Lithium from CCTS Boiler Reactor and disposal system for safe disposal of irrecoverable Lithium were developed and operations standardized.

Fabrication of helium liquefier cold box containing heat exchangers, internal gas purifier,

cryogenic valves, turbo expanders and interconnecting piping was completed. A cryostat for testing of superconducting RF cavities was designed for a dynamic load of 55 W at 4.5 K. Indigenously developed micro cryo-cooler unit was fabricated, tested and integrated successfully with Hand Held Thermal Imager meant for night vision device. A minimum temperature of 59 K was achieved without load and it is supposed to provide 230 mw cooling for the sensors at 77 Kelvin.

A landmark in the development of silicon technology was achieved by producing India's first large size crystal of ultra high purity silicon by Float Zone crystal puller. Single crystals of silicon having two major crystal orientations of industrial application were successfully pulled. These crystals range from 75 to 100 mm in diameters and up to 1000 mm length.

The refurbished fast neutron facility was made operational

# Advanced Technologies and Radiation Technologies and their Applications



*Silicon single crystal  
(105mm dia. &  
1000mm long)  
pulled*

using the d-d reaction and a neutron flux of a few times  $10^7$  was measured. A Low Energy negative ion Accelerator Facility (LEAF) which can deliver ions and clusters of energies upto 50 keV and a range of masses from H to U was made operational for multidisciplinary research programmes.

As a part of the indigenous development of precision mass spectrometers for DAE programmes, a state-of-the-art Quadrupole Mass Spectrometer (QMS) was designed and developed for RMP, Mysore. A neutron radiography facility was commissioned at the refurbished CIRUS reactor and is being used for non-destructive imaging of materials.

Several excitation/emission multilayer interference filters were developed by bipolar pulsed dc-magnetron sputtering for radio-photoluminescence dosimetry application.

At Kalpakkam, the irradiation

facility at KAMINI Reactor was successfully utilized for the qualification of certain critical sensors and transducers based on opto-electronics as well as micro-electromechanical systems (MEMS) developed indigenously by ISRO, Bangalore. Neutron irradiation nearly simulates the degradation of these components

under high-energy cosmic radiation during the satellite mission life in orbit. A few sensors such as phototransistors, Infra Red Light Emitting Diodes (IRLED) and solar cells were subjected to neutron irradiation up to a fluence level of  $1 \times 10^{11}$  n/sqcm. Preliminary results indicate bright prospects.

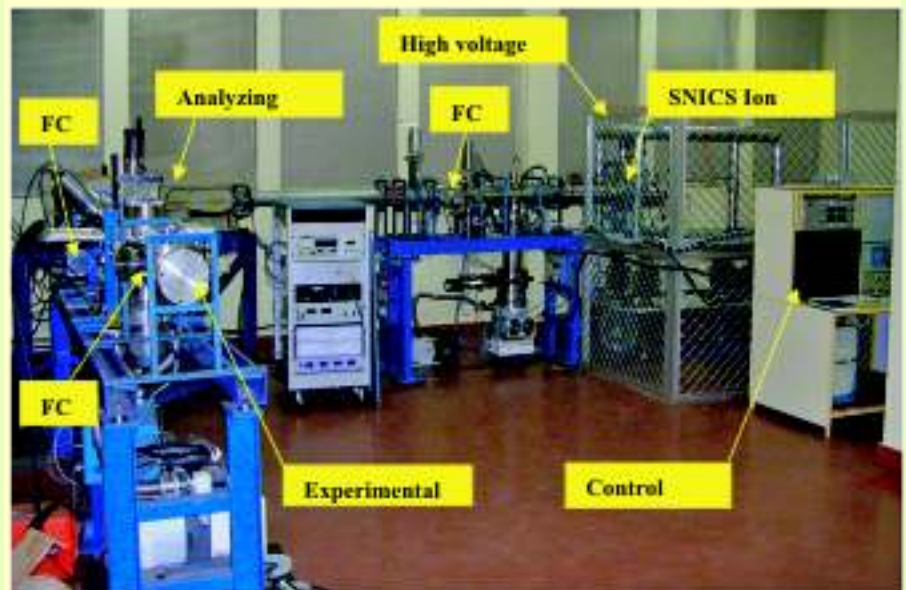

*Low Energy negative ion Accelerator Facility*

# Advanced Technologies and Radiation Technologies and their Applications

## SPECIAL PROGRAMMES

The experimental scenarios of the BPR test facility at P-4 were analyzed. The predicted counts per second and the interpreted worth of devices agreed well with the observed ones. EXCEL-TRIHEx-FA code system was used to analyse four power campaigns of PRP, Kalpakkam reactor.

## ISOTOPE PROCESSING

Regular production of radioisotopes for medical applications ( $^{99}\text{Mo}$ ,  $^{131}\text{I}$ ,  $^{125}\text{I}$ ,  $^{153}\text{Sm}$ ,  $^{32}\text{P}$ ,  $^{51}\text{Cr}$ ,  $^{177}\text{Lu}$  etc.) continued. 114TBq of radioactivity was processed in 145 batches and 1156 consignments were dispatched to various nuclear medicine centers in the country through BRIT. Industrially important isotopes ( $^{203}\text{Hg}$ ,  $^{82}\text{Br}$ ,  $^{46}\text{Sc}$ ,  $^{140}\text{La}$  etc. 36 GBq in 7 batches of 171 consignments) were also produced and supplied for various industrial procedures and hydrology studies. The radioisotope requirements of DAE family and other national laboratories and universities were also met through BRIT (961 GBq in 25 batches of 97 consignments).  $^{143}\text{I}$  seeds (111-130 MBq each) were supplied to various hospitals for the treatment of ocular cancers.

To reduce Men-Rem expenditure four numbers of 100 mm lead shielded plants with complete automation system with remote gadgets were

commissioned for the production of  $^{153}\text{Sm}$  and  $^{177}\text{Lu}$  for therapeutic applications. Three different radioisotopes viz.  $^{143}\text{Pr}$ ,  $^{161}\text{Tb}$  and  $^{111}\text{Ag}$  were investigated for production in no-carrier added form (nca) by (n,  $\gamma$ ) followed by beta decay. In continuation of the work on the development of a dry distillation method for the production of  $^{131}\text{I}$ , a few active experiments in trace level were carried out to reduce the Te content in the final product.

Three sources of  $^{57}\text{Co}$  (370 MBq each) prepared by electrochemical deposition technique were supplied for radiometric assay of nuclear fuel rods and Three  $^{147}\text{Pm}$  beta point sources (33MBq each) prepared by anodic cum adsorption technique were supplied for checking graphite coating thickness of PHWR fuel rods. ~1000 numbers of reference sources of activities ranging from 37 kBq to 3.7 MBq were supplied to various users through BRIT.

During the April-Dec 2009 period BRIT produced sealed radiation sources and supplied for the following irradiators :

- 100 kCi for Jhunsons Ltd., Bhiwadi, Rajasthan
- 134 kCi for Microtrol, Bangalore
- 200 kCi for Universal Medicap Ltd, Vadodara
- 100 kCi for Sriram Institute, Delhi
- 57 kCi for IFRT, PANBIT, Bangladesh

BRIT has further plans to load sources in the following irradiators during Jan- Mar, 2010

- 100 kCi for Krushak, Lasalgaon
- 200 kCi for Agrosurg, Vasai
- 100 kCi for Innova, Bangalore
- 60 kCi for Rahuri Irradiator
- 100 kCi for Vietnam

Cobalt-60 for one blood irradiator 743 Ci and Cobalt-60 with a total activity of 41 kCi for four Gamma Chambers were supplied. More than 1000 fresh Iridium radiography sources will be fabricated and supplied with 40,000 Ci of Ir-192 activity in the radiography cameras to various users. 60 decayed sources were removed from the hot cells. 10 sources for Co-60 radiography cameras with 450 Ci of activity were supplied. One metre of Ir+Pt wire was supplied with 500 mCi activity.

Three consignments of Sc-46 with 8 Ci each were supplied for various ports for sediment transportation studies. Around 10,000 consignments of various isotopes were packed and dispatched to various users in industry and medicine during this period.

At Kalpakkam, an experimental assembly containing irradiated yttria pellets was cut remotely using laser beam and the pellets retrieved were dispatched for separation of medical isotope strontium-89 for alleviation of pain in cancer patients.

VECC aims at installing a



# Advanced Technologies and Radiation Technologies and their Applications

30MeV Medical Cyclotron for medical purposes and as a major research facility for material science and other fields. All the components of the facility arrived at VECC. This cyclotron will also produce PET and SPECT isotopes for medical diagnostics.

## AGRICULTURE

New Trombay groundnut varieties TG39 and TG51 were released for commercial cultivation by the Ministry of Agriculture, Government of India. TG51, a Trombay groundnut variety was released for Rabi/summer season (October-May) in Orissa, Bihar, and West Bengal and North-eastern states under residual moisture situation.

In the breeder seed programme for Trombay groundnut varieties, 262 quintals of TAG-24, TG-37A, TG 38, TPG-41, TLG 45 and TG 51 was produced and distributed to 29 seed growing agencies such as National Seed Corporations, State Farms Corporation of India, State Seed Corporations, ICAR institutes, State Agricultural Universities, NGOs, Seed companies and farmers.

In cowpea, Trombay entry TC-601 was promoted from AVT-1 to AVT-2 based on its high yield and quality in Northern Locations of India in the Co-ordinated varietal trial conducted by ICAR. A mutant TCM113-1 was identified with high pod filling index and low environmental interaction.

In mungbean, a mutant selection TMB-47 gave 28%

higher yield over best check ML-5 in All India Co-ordinated Varietal trials for kharif season in North Hill Zone in AVT-2.

In mungbean, a gamma ray-induced long root mutant (71 cm) of cv. Samrat (20 cm) was isolated and purified for its stability. Sixteen large seed mutant lines (5.5 to 6.0 g/100 seed weight) of cv. Samrat (3.5 g/100 seed weight) were identified and evaluated in M6 generation.

In urdbean and soybean, multiplication was undertaken of selected mutant lines and high yielding genotype for supplying seed to the ICAR trials and of advanced lines from the cross between LBG17 x Nayagar and Nayagar x LBG17.

In soybean, a quick, economical and reliable methodology for screening phytic acid content in large mutated population was standardized as part of the IAEA CRP Project on Development of low phytic acid soybean lines through induced mutagenesis and their molecular characterisation.

In wheat, recombinants with early flowering and moderate rust resistance were isolated in the background of Cv.C306.

In rice, 65 salinity tolerant and Basmati type selections were grown in disease hot spot location at Rice Research Station, Shirgaon, Ratnagiri, Maharashtra and five were found to be immune and twenty tolerant to these diseases. CSR 30, a salt tolerant and high yielding lodging susceptible basmati rice variety

was subjected to 25 and 30 kR gamma ray irradiation and in M3 generation fifteen dwarf and semi-dwarf mutants were isolated. Few tall, lodging resistant, high yielding and less tillering mutants were also isolated.

In pearl millet, selected mutant populations (M1 and M4) were field evaluated at the experimental Gamma field facility and selected M5 populations were sent to Bajra Breeder, College of Agriculture, Dhule, Maharashtra for further evaluation.

In cowpea (*Vigna unguiculata* L. Walp.), unigene sequences were analysed in silico for the presence of simple sequence repeats and a total of 1,071 SSRs were identified. These unigene SSR markers showed a high rate of transferability (83%) across other *Vigna* species thereby expanding their utility. In pigeonpea and mungbean, RAPD markers tightly linked (< 9 cM) with plant type trait and mungbean yellow mosaic virus resistance were identified for use in marker assisted selection.

In rice, thirteen dwarf and semi-dwarf mutants developed in Basmati 370 background were DNA fingerprinted with 35 SSR primers. Mutant-specific polymorphic SSR markers either alone or in combination, were detected.

In wheat, marker assisted selection for Sr24, Sr26 and GluD1d was carried out in a F2 population derived from a cross FLW-2 x Kite. One hundred wheat

# Advanced Technologies and Radiation Technologies and their Applications

varieties and genotypes were analyzed for variation at Pin locus. Seven of the varieties carried wild type allele and eighty eight varieties showed mutant allele at Pina locus. Five varieties were shown to have mutation at both Pina and Pinb locus.

In grapevine, protocol for micropropagation via axillary buds of rootstocks was standardized and plants recovered. Synthetic seeds were prepared using axillary buds and healthy plants were regenerated after storage at 40C for eight weeks. A novel regeneration protocol was developed for two Indian potato cultivars (Kufri Jyoti and Kufri Bahar) using leaflet explants.

In banana, 210 tissue culture derived banana plants were sent to AKRUTI-CARD for field planting. A miniature commercial tissue culture laboratory for AKRUTI-CARD at Anjangaon-Surji, Amravati, was completed for initiating tissue culture production of banana plants. In vitro multiplication of cv. Giant Cavendish (AAA) and its two mutants (two dwarfs and a semi-dwarf) was done.

Work on plant tissue cultures of medicinal plants such as *Ophiorrhiza*, *Coleus amboinicus* and *Adhatoda vasica* was undertaken for the production of important known and new secondary metabolites.

Hairy roots were cultivated in 250, 500 and 1000 ml Erlenmeyer flasks for increased biomass level and phytoestrogens production.

Spent medium contained trace amount of daidzein and genistein. A three-litre capacity bioreactor designed for scale up of hairy roots and phytoestrogens production over a period of 21 days indicated 14-fold increase in biomass and production of daidzein and genistein, which was ~9-10 fold higher than field grown plants.

Transformation studies using different gene constructs were undertaken for fungal disease resistance, cold tolerance, fruit ripening and virus resistance in different crop plants like Brassica, banana and tobacco. Transgenic banana plants were established via embryogenic cells transformation with four expression cassettes containing HBsAg driven by a strong banana fruit specific promoter (pBAC-HER-Nos, pBAC-HER-VSP, pIFR-HER-Nos and pIFR-HER-VSP). A novel transient *A. tumefaciens* genetic transformation system for short-term expression studies was developed using embryogenic cell suspension cultures of banana. Transgenic banana plants were raised containing fatty acid desaturase (FAD7) gene for cold tolerance and two *ihp*-RNAi binary vectors were constructed using BBTV replicase and a portion of replicase promoter for bunchy top virus resistance in banana. In Brassica, an endochitinase gene 'ech42' was introduced to enhance fungal disease resistance and putative transformed shoots obtained were screened. Transformation of

*Brassica juncea* was carried with synthetic 'cryIAc' gene for developing insect resistance. Few elongated shoots were analysed for confirmation of integration of transgenes by PCR analysis showed presence of all the three genes.

To enhance the potential of plants for metal acquisition, heterologous metal transporter genes were introduced into tobacco plants. Studies on bioregulatory molecules (thiourea, TU) were conducted to understand the molecular mechanisms involved in improving abiotic stress tolerance in the Indian mustard. The expression profile of different PIPs (plasma membrane intrinsic proteins) studied under salt stress with/without thiourea demonstrated an upregulation upon salinity stress imposition, and downregulation upon TU supplementation. TU treatment also led to a decrease in the accumulation of reactive oxygen species and delimited the need for an enhanced accumulation of osmolytes. TU mediated change was also observed in redox state and antioxidant enzyme activities in 15-d old mustard seedlings subjected to NaCl and/or TU. In order to identify a suitable marker for salinity stress tolerance, ERD-4 (early responsive to dehydration) gene was isolated using suppressive subtractive hybridization and an in silico analysis suggested that it codes for a transmembrane protein with one cytoplasmic domain.

# Advanced Technologies and Radiation Technologies and their Applications

The uranium (U) accumulation potential and ensuing biochemical responses were studied in *Hydrilla verticillata* (L.f.) Royle upon exposure to U (0, 20 and 100 mg L<sup>-1</sup>). A concentration-duration dependent increase in U accumulation with the maximum being 78 mg g<sup>-1</sup> DW at 100 mg L<sup>-1</sup> U after 24 h. Study was carried out to understand the effect of various metals present in Uranium Nitrate Raffinate (UNR) in the biological denitrification process. The effect of Cu concentration on nitrate removal kinetics and of nitrite removal kinetics were investigated. It was observed that even if Cu was present in less concentration (lowest 25 ppm) it affected the denitrification process.

Studies on bioaccumulation of cadmium and copper by *Pseudomonas* sp. were conducted. Growth of the bacteria declined significantly with increasing concentration of Cd while it was marginally lower in presence of copper in single metal condition (SM). Multimetal (MM) condition with/without the presence of NaCl, 0.5M (MMS) though adversely affected the growth, more than 70 % growth was retained in comparison to the control. Intracellular Cd and Cu accumulation played an important role in MM and MMS in contrast to SM where cell wall bound metal was the major contributor. Cysteine content decreased rapidly with increasing concentration of Cu and Cd as well as in MM and MMS

indicating its involvement in metal accumulation. High GSH/GSSG ratio was observed in presence of Cu and Cd, in isolation or together with other metals and salts. Glutathione reductase (GR) activity in MM was higher than control and MM. Though there was no significant change in GR activity till 1 mM Cu or Cd, further increase in concentration reduced its activity significantly.

Morphological transition of droplets during evaporation driven self-assembly of colloidal dispersion of alumina nanoparticles was investigated. A novel technique was developed to obtain porous and stiff microspheres of silica by evaporation driven self assembly wherein *Escherichia coli* served as template and silica nanoparticles as imprinted matrix. Synthesized Iron oxide nanoparticles were stabilized using polycationic polymer. Invertase was used to study protein binding to nanoparticles, re-usability, changes in pH, temperature optima and thermostability assays. Biosynthesis of silver and gold nanoparticles was achieved using the extract of the plant *Lagerstroemia indica*, *Trixax procumbens*, *Mangifera indica* and *Psidium guajava*.

Molecular dynamics simulations using GROMACS 4.0.5 were carried out to explain *Candida rugosa* lipase (PDB id: 1CRL) instability in methanol. Increasing solvent accessible

surface area and radius of gyration indicated opening of the protein thus loss of structure, accounting for methanol instability.

Screening and isolation of extracellular lipase producers from soil was carried out using the Rhodamine B-olive oil plate method. Six cultures showing maximum enzyme production were isolated.

Presently 60 Nisargruna plants of various capacities have been set up in various parts of the country. A 0.5 MT/day capacity plant at Defense Institute for High Altitude Research for use in temperate regions.

## FOOD PROCESSING

The studies on the effect of chitosan-glucose complex (CGC) spray alone and in combination with irradiation (1 kGy) on the shelf life of mutton chops stored at chilled temperature revealed that combination of irradiation and CGC extended the shelf life of mutton chops to 21 days while maintaining their microbiological quality. Antimicrobial activity of nisin-dextran, nisin-glucose and nisin-chitosan conjugates prepared by gamma irradiation (100 kGy) was demonstrated. Use of EPR and TL measurements for detection of irradiated pet foods was also demonstrated.

Effect of chitosan coating on the shelf life of ready-to-cook chicken chilly, chicken reshmi kabab and chicken lolipop showed the control samples spoiled within 3 days while the chitosan coated



# Advanced Technologies and Radiation Technologies and their Applications

samples had a shelf life of 12 days. Studies on occurrence of *Salmonella* sp. in egg and chicken samples indicated that while this organism was absent in the former, presumptive positive isolates were obtained in the latter. ACE inhibitory peptides purified and characterized from poultry viscera protein hydrolysate were found to be stable in the pH range of 2-10 and temperature up to 100°C and was resistant to pepsin action.

Fish samples were analyzed for their microbial safety with respect to bacterial pathogens. All samples were presumptive positive for *Vibrio* sp.

Radiation processing (7.5 kGy) of an antidiabetic herbal formulation “Amritamehari churnam” is found useful in extending shelf life of the drug for one year without affecting its chemical quality, anti oxidant and radioprotective properties. The process was also effective in microbial decontamination of other herbal drugs such as amla and aswagandha without affecting their chemical quality. Aqueous extracts (2%) of guggul was found to possess high antibacterial activity against *Xanthomonas campestris*. Rose and guggul extracts were also shown to possess high radioprotective activity as demonstrated by retention of antibacterial activity of antibiotic solutions when irradiated with a dose of 10 kGy. These herbal extracts were also found to significantly protect the naked plasmid DNA from

radiation induced damage. The possibility of using nutmeg essential oil and its fraction containing elemicin and cis-beta-terpeniol with high antioxidant activity as a food preservative was demonstrated.

A radiation dose of 0.5 kGy resulted in 1 log cycle reduction in bacterial and fungal load (both surface and internal) and an extension in shelf life of lichi fruit by 25-28 days. Radiation did not affect the color of the fruit as measured by the browning index. A combination treatment was designed using potassium metabisulphite, sodium hypochlorite, ascorbic acid and hydrochloric acid in order to maintain the litchi pericarp color. Retention of the pinkishred pericarp color was observed up to 60 days of storage at 4C. Antioxidant activity of juice from the irradiated fruit was also not significantly altered even after storage up to 30 days at 4C. A combination of irradiation (2 kGy) and packaging in cling film aided in extending shelf life of RTC cut pumpkin and drumstick by 14 and 5 days respectively when stored at 10°C. Aroma impact compounds of ash gourd and pomegranate was identified as acetoin and Z-3-octenyl acetate and their structures were confirmed by chemical synthesis. Using hurdles such as osmotic dehydration, infrared drying and gamma radiation (1kGy) shelf stable and microbiologically safe papaya cubes were prepared that could be

stored for 60 days with acceptable sensory quality. Benzyl alcohol and methyl salicylate were identified as the major aroma precursors in chickoo (sapota) that contribute to its characteristic odor. In grapes (Sonaka variety) enhanced aroma of the fruit during radiation processing was found to be the result of liberation of several aliphatic C7-C9 aldehydes from their glycosidic precursors. PPO gene from brinjal was cloned and the protein overexpressed in *E. coli*.

A significantly lower content of oligosaccharides and a higher diastatic power of the irradiated malt extract were observed in radiation processed sorghum. Products prepared by incorporating irradiated malt had sensory attributes compared to the non-irradiated samples. Studies on the effect of radiation processing (0, 1.0 and 10.0 kGy) on the antioxidant potential of Flax seed cake and rice bran showed no significant change in the antioxidant potential as well as in the total phenolic content in both the samples. Radiation processing up to 10 kGy was found to have no effect on the antioxidant activity and phenolic content of sesame and groundnut meal. A dose dependent increase in the hydration capacity of the sesame meal was, however, discernible with an increase of 10% and 22% at radiation doses of 1.0 kGy and 10 kGy respectively. Products such as Thalipeeth, stuffed (besan) Paratha and wheat

# Advanced Technologies and Radiation Technologies and their Applications

flour halwa, prepared by incorporating radiation processed meals had sensory scores comparable to the non-irradiated samples. Among the moong, chana and tur dal, chana dal had the highest antioxidant activity. At a concentration of 0.1% it inhibited the growth of *B. cereus* and at 0.2% reduced the *S. aureus* counts by one log cycle.

Protocols were standardized for the development of active and intelligent food packing. A combination of chitosan (1%) and guar gum (1%) with glycerol (0.1%) as plasticizer resulted in films with high water vapour transmission that showed antimicrobial activity against *E. coli* and *S. aureus*. However, films prepared using 85% chitosan, 15% guar gum and 0.1% glycerol had better mechanical strength including tensile strength and puncturability and possessed high antimicrobial activity. Preparation of edible films by various combinations of tomato puree either with ginger garlic paste or with dextrose and glycerol resulted in stable films with good flexibility. Maize bran was successfully employed as a source of ferulic acid and also as a growth medium for efficient production of 4-vinyl guaiacol, a commercially important aroma chemical, by a bacterial strain identified (16S rDNA sequence) as *Bacillus subtilis* AR-1. The organism was also found to be a glutamate independent producer of poly gamma glutamic acid

(PGA), a biopolymer, of immense commercial value. Under the experimental conditions standardized, high yields (90 g/kg) of this biopolymer was obtained. Methods were standardized to assess biofilm formation by *Aeromonas* species that colonize and form films in drinking water distribution and food processing systems. Use of radiation as a tool for formation of protein conjugates such as lysozyme-dextran complex with improved functional properties such as antioxidant and emulsification properties was demonstrated. Attempts were made to identify the bacterial strain producing an antifungal metabolite which characterized as a *Bacillus* species by 16S rDNA amplification. Sequence comparison revealed 99.4% homology of the isolated strain with *Bacillus velesensis* and 98.2% homology with standard *Bacillus amyloliquefaciens* FZB42.

Studies on radiation resistance of *Deinococcus* species continued. The DR0070 protein from *Deinococcus radiodurans*, an important protein involved in post-radiation recovery of the organism, was successfully expressed in *E. coli* and its identity was confirmed by MALDI-TOF. Studies on oxidative stress resistance of *D. radiodurans* R1 with respect to different phases of growth showed that late stationary phase cells of *D. radiodurans* R1 were resistant to  $H_2O_2$  stress as

compared to the exponential phase cells. Live dead staining techniques using fluorescent dyes was standardized for studying viable but not culturable (VBNC) state of *Vibrio* species. These organisms are known to attain VBNC state when subjected to cold and starvation stress. However, no VBNC induction was observed in *V. vulnificus* YJ016 and *V. parahaemolyticus* indicating that VBNC phenomenon in *Vibrio* group is strain specific. Real time PCR assay for *Salmonella* was standardized. The assay was able to detect 104 CFU/ml of *S. typhimurium* cells. Characterization of biochemical mechanism involved in programmed cell death (PCD) of *Xanthomonas* (Xcg) was further investigated. Oxidative stress was shown to have remarkable effect on Xcg cell viability. The involvement of superoxide and hydrogen peroxide free radicals in PCD process of Xcg was demonstrated. Hydrogen peroxide was also found to activate caspase-3 enzyme in-vitro indicating the probable involvement of hydrogen peroxide in intercellular signaling during PCD in Xcg. Investigation of cell death and sporulation in *Bacillus subtilis* showed that cultures undergoing sporulation also exhibited induction of caspase-3-enzyme activity.

Dosimetry and calibration work related to gamma chambers and Food Package Irradiator was

# Advanced Technologies and Radiation Technologies and their Applications

routinely carried out. Fruit scanning X-ray machine was installed and used for scanning of mangoes and litchi for detection of fruit defects and insect infestation. Cesium Food Irradiator was refurbished and a new control system was installed.

## ***Radiation Processing Plant, Vashi***

Radiation Processing Plant, Vashi continued to provide gamma radiation processing services for spices, ayurvedic raw material and pet feed etc. to more than 130 customers from all over the country. During the current financial year, about 1600 MT of spices and other products were processed till November 2009 which is 86.5% increase in quantity over the corresponding period of the last year (857 MT).

During the report period, the plant is expected to process around 2400 MT spices and allied products yielding revenue of about Rs.150 lakhs. Since its inception, this facility has processed about 13,000 tonnes of products realizing revenue of about Rs. 700 lakhs. Source replenishment was carried out in December, 2009 and source strength was enhanced from 255 kCi to 454 kCi. to cope up with the increased demand for radiation processing.

The facility was accredited with ISO-9001:2000 (Quality Management Systems) during the current year and BRIT are in advanced stage of getting ISO-

22000:2005 (Food Safety Management Systems) accreditation.

## ***KRUSHAK***

A tripartite agreement was signed with Maharashtra State Agricultural Marketing Board and BARC for the service operation of KRUSHAK (Lasalgaon, Nashik) from this year by the board for 3 years. Approx. 130 tonnes mangoes were processed and exported to US by various exporters.

The facility is being upgraded for multi-tasking by BARC i.e. to convert it into a multi product processing unit covering wide range of food products requiring low dose to medium dose exposure. This work was scheduled to be completed in January 2010. Cold rooms were provided at loading and unloading areas for transit storage of mangoes.

Calculation of absorbed dose to the product was carried out by BARC with the new source shielding planned to be incorporated to make the facility multitasking.

## ***New Radiation Processing Plants***

The construction of radiation processing plant of M/s Jhunsons Chemicals Pvt. Ltd. was completed and commissioning dosimetry jobs were completed. The source loading is expected to commence commercial operations soon.

## ***Refurbishment of AERE Bangladesh's Irradiator***

A contract was received from Institute of Food & Radiation Biology, AERE, Bangladesh, for refurbishment and loading of Co-60 pencils. The PANBIT flask was brought to Mumbai & source was replenished. All other services such as dosimetry etc. were completed and plant was handed over back to AERE.

## **HEALTH**

### **Radiation Technology**

Development of robotic control of endoscope in laparoscopic surgery was taken up.

Based on the agreement signed among IAEA, Govt. of India and Govt. of Vietnam, BARC supplied one 'Bhabhatron' Machine and Cobalt-60 source to Vietnam.

BARC has developed a Radiotherapy Simulator for diagnosis and localization of cancer using diagnostic X-ray as the source of radiation. The simulator helps in choosing the radiation beam and aiming it to the target. The machine was recently commissioned at Indian Red Cross Society Hospital, Nellore.

Peripheral Pulse Analyzer was developed to record the peripheral blood flow pulse at wrist location for morphology, propagation and variability analysis. These units were supplied to Regional research Institutes of Central Council for Research in Homoeopathy at Bhubaneswar



# Advanced Technologies and Radiation Technologies and their Applications



*Lab system using Industrial Robot*



*Field system using specially developed manipulator*

and Mumbai, for investigating their application in detecting the response of material-less medicines.

The Handheld Tele ECG was upgraded for Mobile as well as LAN application and supplied to Post Graduate Institute of Medical Education and Research, Chandigarh and Grant Medical College and J.J. Hospital, Mumbai for validating its application in Rural Health Care. The technology was transferred for commercialization. A software utility was developed for transferring medical images from PC based Systems to the mobile phone. This image can be transferred from the mobile in rural area to the mobile of the expert for his opinion on patient management.

An electrochemical generator for obtaining  $^{99m}\text{Tc}$  from neutron irradiated  $^{99}\text{Mo}$  was developed. The quality of the separated  $^{99m}\text{Tc}$  was found suitable for clinical applications. Development of two radiopharmaceutical agents

viz.  $^{177}\text{Lu-EDTMP}$ , as a bone pain palliative and  $^{177}\text{Lu-DOTA-TATE}$  as a radiotherapeutic agents for neuroendocrine tumors carried out. The preclinical dosimetric

studies of  $^{177}\text{Lu-EDTMP}$  were completed and the Phase I/II clinical trials are being currently conducted. Preparation of therapeutic doses of

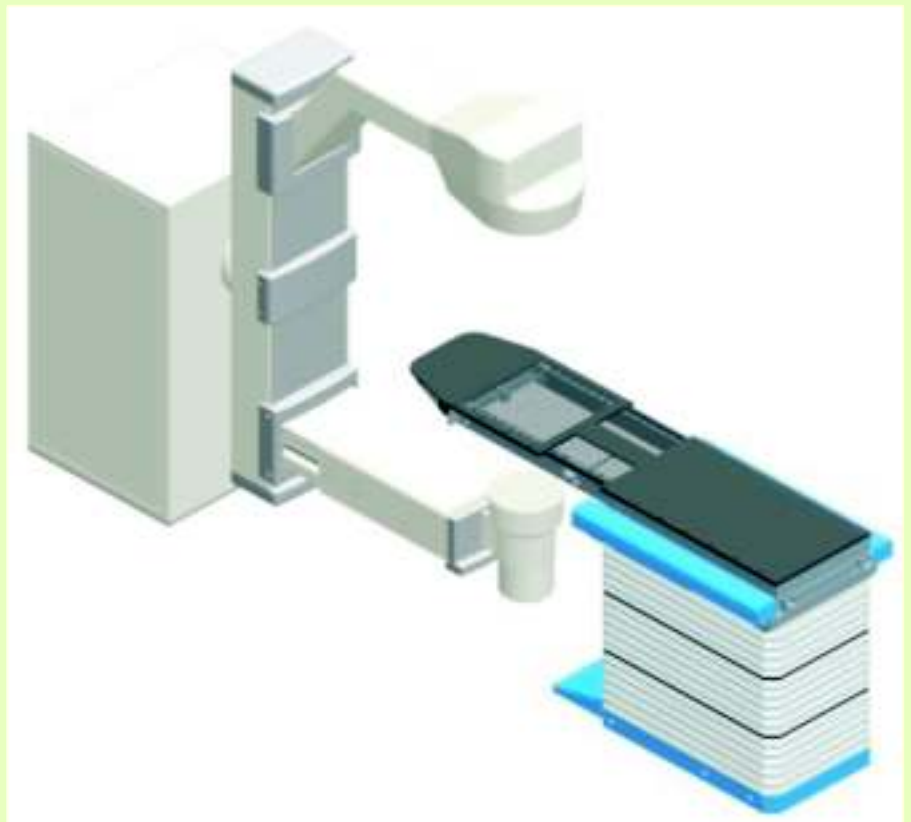

*Radiotherapy Simulator*

# Advanced Technologies and Radiation Technologies and their Applications

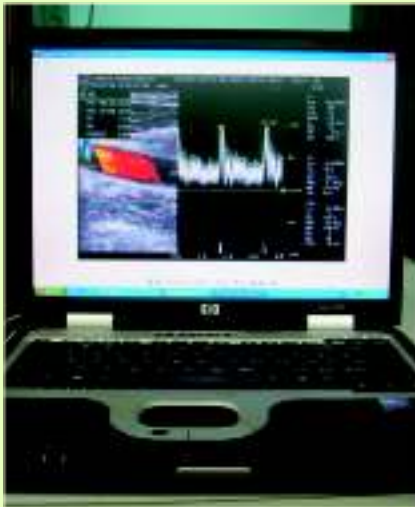

*Handheld Tele ECG for Mobile & LAN Applications*

using the EGSnrcMP-based Monte Carlo code system. These dose rate values can be used as input data for treatment planning for the indigenous development of treatment planning software.

Water equivalence of various solid phantoms was studied for  $^{60}\text{Co}$ ,  $^{137}\text{Cs}$  and  $^{192}\text{Ir}$  sources. Based on the results, distance dependent correction factors were established for solid phantom materials for a given brachytherapy source. Also, energy response of different solid detectors used in brachytherapy dosimetry was studied using Monte Carlo methods for low energy brachytherapy source such as Iodine-125.

A rotating perspex phantom was designed and fabricated for the purpose of Image Modulated Radiotherapy (IMRT) dose verification.

A cylindrical graphite

$^{177}\text{Lu}$ -DOTA-TATE, using indigenously produced  $^{177}\text{Lu}$  was standardised. This agent is currently undergoing clinical trials in human patients, in collaboration with four participating hospitals. Therapeutic doses (100 numbers, 3.7-7.4 GBq each) of this agent

were administered in 54 patients suffering from various types of neuroendocrine tumours till date and the preliminary results were encouraging.

The dose rate distribution in water for the indigenously developed CSA1 and CSA2  $^{137}\text{Cs}$  source models was calculated



*2D matrix ionization chamber system embedded Phantom with Farmer type ionization chamber for in the phantom to measures the composite dose the point dose verification in IMRT distribution for IMRT dose verification*

# Advanced Technologies and Radiation Technologies and their Applications

ionization chamber was designed and fabricated for use as a reference ionization chamber to determine the strength of high dose rate (HDR)  $^{192}\text{Ir}$  brachytherapy sources in terms of reference air kerma rate (RAKR). The air kerma calibration coefficient, NK, was estimated for this ionization chamber analytically using Burlin general cavity theory and by Monte Carlo method. The Monte Carlo calculated NK agreed within 1.77 % of that obtained by analytical method. The ionization chamber can now be used to calibrate hospital dosimeters.

## Radiopharmaceuticals

16,000 consignments of ready to use radiopharmaceuticals of  $^{131}\text{I}$ ,  $^{32}\text{P}$ ,  $^{51}\text{Cr}$  and  $^{153}\text{Sm}$  were supplied to various Nuclear Medicine Centres. Majority of these contained  $^{131}\text{I}$  radiopharmaceuticals, which amounted to about 550 Ci; 14200 consignments. The use of following injectables  $^{153}\text{Sm}$ -EDTMP and  $^{32}\text{P}$  as sodium orthophosphate was increased to various nuclear medicine centres in India 350 Ci of  $^{99}\text{Mo}$  (TCM-2) was supplied for extraction of  $^{99}\text{mTc}$  at hospitals. In addition to this various accessories of  $^{99}\text{mTc}$  solvent extraction generator system and other products were supplied. About 54,000 cold kits for formulation of  $^{99}\text{mTc}$  radiopharmaceuticals (code-TCK: 11 Products) were supplied



*A view from Radiopharmaceutical lab of BRIT*

to various Nuclear Medicine Centres.

The ongoing contract work, of monoclonal antibody (ch TNT 1/B) labelling with  $^{131}\text{I}$ , for M/s Peregrine Pharmaceuticals Inc., USA, continued in 2009 and the contract was extended further for the year 2010.

Under the XI plan, work continued on a new project for the production of  $^{99}\text{Mo}$  /  $^{99}\text{mTc}$  Column generator using high specific activity  $^{99}\text{Mo}$ . The fabrication of facility has reached completion at the works of the supplier German Company.

Two new products a) Kit for the preparation of  $^{99}\text{mTc(III)}$ -DMSA injection (Code: TCK-33), for renal imaging, and b) Single component Kit for the preparation of  $^{99}\text{mTc}$ -MIBI injection (code:TCK-50 A), for myocardial perfusion imaging, were developed. Radiopharmaceutical Committee (RPC) granted approvals for regular production and supply of these products. These will be introduced in the production and supply soon.

The shelf life for kit for the preparation of  $^{99}\text{mTc}$ -MDP injection (Code:TCK-30), a skeletal imaging agent, was enhanced from 4-10 months and was approved by RPC.

In the third year, since commencement of supply of Tc-99m Geltech generators to Nuclear Medicine Centres, the Technetium Column Generator Production Facility has been operational. An uninterrupted supply of generators as per schedule was maintained throughout the year despite uncertainties/disruptions in the availability of imported fission produced Mo-99. For a period of five months of the year, the generator supply was sustained using indigenous reactor produced Mo-99 alone. Weekly supply was introduced since April 2009 against the existing fortnightly supply to cope with increased market demands.

547 generators were supplied in this period registering an overall growth of around 60% which is a commendable achievement.

## Medical Cyclotron

At the Regional Centre, Kolkata, significant progress was made in the DAE Medical Cyclotron Project.

- FAT acceptance tests of hot-cells and associated systems were successfully completed at the factory of M/s COMECER, Italy.



# Advanced Technologies and Radiation Technologies and their Applications

- All the shipment (containing various cyclotron systems and radioisotope production equipment) from M/s IBA, Belgium and M/s COMECER were received.

Standardization of pulse electroplating of metal using square wave pulse was carried out.

Nickel was successfully electroplated earlier on a copper substrate using square wave pulse and platinum anode. Presently standardization of pulse electroplating of Cd and Co are going on and this work would be completed in couple of months. These electroplated targets would be useful for irradiation in cyclotron for radioisotope production.

Pulse electroplating of Cu was carried out successfully. An electromechanical bath was designed and fabricated at VECC to carry out this work. Development of separation of (a) Cu and Ni and (b) Cu and Zn using ion-exchange chromatography was carried out. Progress was made in the development of a novel  $^{99}\text{Mo}/^{99}\text{mTc}$  generator using Alumina column and MEK. Separation of  $^{131}\text{I}$  using solvent extraction method was carried out.

## **Nuclear Diagnosis & Treatment**

About 6500 kits of radioimmunoassay (RIA) and immunoradiometric assay

(IRMA) were produced and supplied to over 300 immunoassay laboratories throughout the country till November 2009 (projection April 2009-March 2010: 9800 kits).

The development of user-friendly IRMA kit for Luteinizing hormone (LH) based on in-house produced magnetizable cellulose particles was completed. The developed product was approved by the Radiopharmaceutical Committee (RPC) for regular production and supply.

Commercial supplies of free T4 RIA kits produced using liquid handling system was made effective after rigorously evaluating indigenously fabricated high throughput automatic liquid handling system capable of handling all the steps required for the large scale production of antibody coated tubes. Now the kits are being produced in a well-equipped laboratory specifically designed for this purpose.

Improved T3 RIA kits based on cost-effective liquid phase separation system were launched. Modified and improved assay procedure makes use of uniform standard and sample volumes and with simplified data processing for the convenience of the analysts.

The Regional Centres located at Bangalore and Delhi processed ready-to-use  $^{99}\text{mTc}$  radiopharmaceuticals for use in the host medical centres apart from supplying the products to other

hospitals in the region. RCR, Bangalore carried out 4400 RIA investigations and supplied 68,200 mCi of ready-to-use  $^{99}\text{mTc}$  formulations. RCR, Delhi produced 45000 mCi of ready-to-use  $^{99}\text{mTc}$  radiopharmaceuticals for nuclear medicine institutes and hospitals in the Delhi region. Research and Development studies were further pursued on development of new Prototype column based alternate  $^{99}\text{mTc}$  Generator based on utilization of SPE method developed by BRIT which is compatible with indigenous reactor produced low/medium specific activity  $^{99}\text{Mo}$  molybdate. Development and evaluation of prototype  $^{99}\text{mTc}$  generator progressed. Retail outlet for supply of cold kits for preparation of various  $^{99}\text{mTc}$  radiopharmaceuticals was utilized by Nuclear Medicine Hospitals in Delhi. Around 700 kits valued at Rs. 15.65 lakhs were supplied.

Regional Centre, Dibrugarh provided RIA & IRMA diagnostic services for the needy patients of the entire North-Eastern region. More than ten thousand patients of the region avail the services from this centre. Apart from medical colleges, patients also come from the nearby tea garden hospitals, civil hospitals etc., For the ICMR national project on Hypertension & Salt intake, 600 assays of serum, Aldosterone and Renin activity was carried out.

# Advanced Technologies and Radiation Technologies and their Applications

## NUCLEAR & BIOTECHNOLOGICAL TOOLS

### *Labeled Compounds*

Labeled Compounds Programme of BRIT remained involved in the synthesis and supply of a variety of  $^{14}\text{C}$ ,  $^3\text{H}$  and  $^{35}\text{S}$ -labelled products, oligonucleotides (DNA primers) and ready-to-use non-radioactive (cold) kits. Cold kits are essentially used for labelling of DNA and RNA to make  $^{32}\text{P}$ -radiolabelled probes. All these products are powerful and versatile tools and are used as radiotracers in diverse investigations in the fields of biology, agriculture, medicine and chemistry.

Labeled Compounds Programme was also involved in the production and supply of tritium filled sources of various types for defence applications. These sources are used for the illumination of various types of military gadgets and instruments. Custom-synthesis of a few compounds was also carried out to meet the specific requirements from a few researchers.

### *Labeled Biomolecules*

JONAKI, the Labeled Biomolecules Laboratory of BRIT at Hyderabad remained involved in the production of  $^{32}\text{P}$  labeled nucleotides required for molecular biology, biotechnology, biomedical and drug discovery research. It also

marketed  $^{35}\text{S}$  labeled amino acids produced at labeled compounds laboratory at BRIT, Mumbai. Further, this laboratory produces and supplied many nucleic acid purification kits, polymerase chain reaction kits and Taq DNA polymerase. This laboratory met the requirements of about 100 research institutes and universities and many industrial research centres. In addition, this laboratory provides services to the Nuclear Medicine Centres around Andhra Pradesh by locally providing nuclear imaging cold kits produced at the radiopharmaceuticals laboratory of BRIT at Mumbai.

JONAKI has entered the field of molecular diagnostics last year by introducing an agarose gel based PCR detection kit for the detection of M. Tuberculosis in collaboration with LNMS, RMC, BARC. An improved multiplex PCR based M. Tuberculosis detection kit was sent for customer evaluation. A real time PCR machine was installed recently which will enable real time PCR applications.

### *Deuterated Compounds*

The development of appropriate methods for the preparation of deuterated compounds and especially deuterated NMR solvents as part of the MoU signed by BRIT with Heavy Water Board was pursued. Salient activities were as follows:

1. Custom synthesis of four

$^3\text{H}$ -labelled compounds, namely Juglone-T(G), Vitamin D3 (T(G), 2-deoxy Glucose T(G) and MK 886 were carried out successfully.

2. As part of the contract manufacturing job with M/s. Peregrine, USA, the quality control assay of four batches of  $^{131}\text{I}$ -labelled antibody was carried out with respect to its ion contents

3. Tritium-filled light sources were supplied to BSF as per the MoU signed between BRIT and BSF.

4. Development of TFS sources for Rocket launcher MKIII CGRL was carried out.

Supply of enzyme, Taq DNA Polymerase, prepared at Jonaki laboratories, Hyderabad, was continued.

## Radiodiagnosis & Treatment

The Regional Radiation Medicine Centre (RRMC) at Kolkata remained engaged in activities such as in-vivo nuclear imaging and non-imaging studies, in-vitro diagnostic studies, and radionuclide therapy. During the report period, about 1570 patients underwent treatment at this Centre. In-vitro diagnostic activities of the Centre covered treatment of around 2500 patients for various thyroid diseases. I-131 therapy was extended to thyroid cancer patients.

RRMC is one of the very few centres in India performing

# Advanced Technologies and Radiation Technologies and their Applications

nuclear hematological studies that is important for management of blood disorders like thalassemia. For such disorders, the Centre treats about 300 cases a year.

## Radioanalytical Services

The BRIT's Radioanalytical Laboratory at Navi Mumbai continued to render analytical service by measuring the residual radioactivity levels in food as well as non-food samples categorized as meat products, Farm products, Dairy products and Miscellaneous products, and issues 'Radioactivity Test Certificates' to exporters which forms an important export document.

BRIT's measurements were guided by the levels of different radionuclides such as  $^{134}\text{Cs}$ ,  $^{137}\text{Cs}$ ,  $^{131}\text{I}$ , etc., as prescribed by AERB. The other radioisotopes such as  $^{226}\text{Ra}$ ,  $^{228}\text{Ra}$  were determined in water samples.

To accommodate various non-food samples, the Food Analysis Laboratory was re-christened as Radio Analytical Laboratory, and measurement of Cobalt-60 in steel samples which is causing concern to the steel manufacturers and exporters of the country, was regularly carried out in this laboratory and certified.

During the year under report, RAL analysed nearly 2400 samples of various categories and about 250 water samples.

## CANCER TREATMENT

The Tata Memorial Centre (TMC), comprising Tata Memorial Hospital (TMH) and the Advanced Centre for Treatment, Research and Education in Cancer (ACTREC) carries out activities in diagnosis, treatment and research in cancer as well as in training and education to provide the highest standard of patient care.

During the year, 30,101 new cases were registered at the Tata Memorial Hospital. In addition, 2447 cases were registered in Preventive Oncology and 14,554 Referral Cards were issued for investigations like mammography, pathology etc. The hospital with bed strength of 564 admitted 19,741 patients and the Dept. of Surgical Oncology carried out 7,565 major operations and 18,579 minor operations. Dept. of Radiotherapy provided radiation treatment to 5078 patients. 91,364 radiological investigations, 1782452 pathological investigations and 115,375 investigations in Microbiology were carried out. Patients admitted to the ICU and Recovery Ward received expert care and attention. 21,597 patients received appropriate and adequate Physiotherapy, Occupational therapy, Speech Therapy, Psychiatry, Palliative and Stoma Care.

During the report period, the TMC Mobile Screening Programme commenced and the Image Guided Radiotherapy

Treatment (IGRT) facility in the TMH Clinic & Faculty Block was inaugurated.

All the Diagnostic Laboratories at TMH except the Cytogenetics Lab. were accredited. New tests were added to improve the diagnosis of infectious diseases. Introduction of the Real Time PCR assays for Cytomegalovirus and Hepatitis B Virus was an important addition for management of these infections.

As part of cancer prevention programme, TMC provided cancer screening services for common cancers and created a model for cancer control programmes for the country and conducted Information Education and Communication programmes aimed at risk prevention, life style modification and improving health seeking behaviour towards early cancer detection and Tobacco Cessation Programmes at various places.

Tata Memorial Hospital in collaboration with ACT-India started a Smoke Free Mumbai campaign.

As part of Societal Initiative, TMC continued its efforts 'Tata Memorial Centre Urban Outreach Programme' in Mumbai and the 'Tata Memorial Centre Rural Outreach Programme' in the districts of Ratnagiri and Sindhudurg, of Maharashtra. A unique Home Care Service for Mumbai patients with their family members on psycho-social suffering and its management made a lot of impact.



# Advanced Technologies and Radiation Technologies and their Applications

The CRS and DAE-CTC renewed its mandate of improving the quality of research in TMC through various initiatives. The CRS also initiated the process of registering clinical trials in a central registry. Hospital Scientific Review Committee and Hospital Ethics Committee of Tata Memorial Hospital exhaustively reviewed 118 projects, out of which 105 projects were approved.

Fifteen teletherapy sources with 151 kCi(2511 RMM) of Co-60 activity were supplied by BRIT to various hospitals for the treatment of cancer. Out of them one source was exported to Vietnam along with the Bhabhatron Unit.

Two numbers of Cs-137 kits with 1600 mCi were supplied to hospitals for brachytherapy. Two Csk-1 kits without the source were supplied to hospitals.

## INDUSTRIAL APPLICATIONS

Under a MoU with Indian Oil Corporation Limited (R&D), Faridabad, a process tomography system is under development. Its major components were designed, developed and installed at site.

Transmission-type tomographic imaging technique was developed using an external radiation source and method of reconstruction technique for mapping the approximate attenuation coefficients of



*Gamma Chamber (GC- 5000) for export to Poland*

materials contained across a specified plane.

A wireless gamma probe was developed for industrial gamma scanning and radiometry applications. The probe consists of a radiation detector and all the necessary electronics for measurement of gamma radiation. The same was in use in the field gamma scanning work.

### Electron Beam Processing

Electron Beam (EB) processing of polymer materials and precious stones continued using ILU-6 EB accelerator. EB processing services were extended to irradiate 13,000 carat of diamonds, 7 lakh pieces of industrial polymer materials and for various BRNS research projects accumulating around ~Rs.15 lakh in revenue.

To ensure the safety of the

industrial material during continuous processing, a special 'Material over-exposure prevention unit' was designed, fabricated, tested and incorporated in the facility conveyor system which can automatically sense and track the movement of product trays and shut down the beam in case of any malfunction.

### Radiation Technology Equipment

During the current financial year, Gamma Chamber GC 5000 was supplied to TINT Bangkok & Warsaw-Poland. More orders are expected to be executed in the coming months.

BRIT supplied 48 nos. of radiography exposure devices up December 2009. It is expected to sell another 25 cameras by March 2010.

# Advanced Technologies and Radiation Technologies and their Applications

341 ROLI cameras were serviced and another 100 cameras will be serviced before March 2010. 725 decayed sources were removed and another 200 sources will be disposed off shortly. 600 imported cameras were inspected and another 200 imported cameras will be inspected in near future.

BRIT had launched a  $^{20}\text{Ci}$  Ir-192 portable radiography exposure device which was developed indigenously. This will compliment  $^{35}\text{Ci}$  mobile device already being manufactured and supplied by BRIT.

The programme of production and supply of Blood Irradiator BI 2000 was pursued further. BRIT supplied one Blood Irradiator to RCC, Thiruvananthapuram. Orders were received from 3 more organisations.

The civil work for the Install & Operate Irradiator was completed. The fabrication of components was completed and the control system was also ready.

Silicon Pad detectors find application in Measurement of Position and Energy of Charged Particles in Nuclear Physics.

Many silicon detectors are required to carry out an experiment approved by Physics Advisory Committee of Institute of Modern Physics of Lanzhou, China in collaboration with GANIL, FRANCE. BRIT had made these detectors in collaboration with Electronics Division, BARC and BEL and



*A column at HPCL, Mumbai*

supplied to them well within the specified period.

## ISOTOPE APPLICATION SERVICES OF BRIT

An underground pipeline, 26 km long and 10" diameter, belonging to Indian Oil Corporation Ltd. (IOCL) was suspected to be leaking. A detector data logger was used to record the leaked out radioactivity and marker sources. The exact location of the leak was identified with respect to the location of the markers. After repairing the leak, hydro-test of the entire pipeline was carried out. It was observed that the pipeline is now holding the pressure indicating that the pipeline had no additional leak.

Gamma Scanning provides a

non-destructive and cost-effective way of analyzing problems of process columns. Scan data is useful for scheduling shutdowns, estimating turnarounds, carrying out periodic maintenance and process optimization.

One of the columns in Hindustan Petroleum Corporation Limited (HPCL), Mumbai was misbehaving. To identify the cause of reduction in the production of aviation turbo fuel obtained from the top portion of the column, HPCL requested QA & IAS, BRIT to carry out the column scanning. Since the column had double pass trays, it was scanned in two chords with collimated 100 mCi Co-60 source and a collimated NaI scintillation detector using automated gamma scanning system. Trays with severe flooding were identified. The results were confirmed by opening the column during shutdown.

## PLAN PROJECTS

Under the X plan, BRIT had initiated following three major projects:

- Integrated Facility for Radiation Technology (IFRT)
- Revamping and Augmentation of Infrastructural Facility (RAIF)
- DAE Medical Cyclotron at Kolkata

There are five more projects which are proposed for execution under XI plan. These projects are aimed at developing new

# Advanced Technologies and Radiation Technologies and their Applications

products, improving quality of existing products and improving manufacturing processes. Financial sanction for four of these projects was received except for the project, Construction of state-of-the-art Immunoassay Facility.

- Integrator Irradiator Development Project
- Production Facility for  $^{99}\text{Mo}/^{99\text{m}}\text{Tc}$  Column Generators of High Specific
- Activity Mo-99.
- Construction of GLP and GMP
- Construction of Immunoassay Facility

## WATER

BARC is developing isotope techniques for the assessment of Hydrological Processes in wetlands. During the report period, 18 water samples from canals, ground water & wetlands, from different locations of

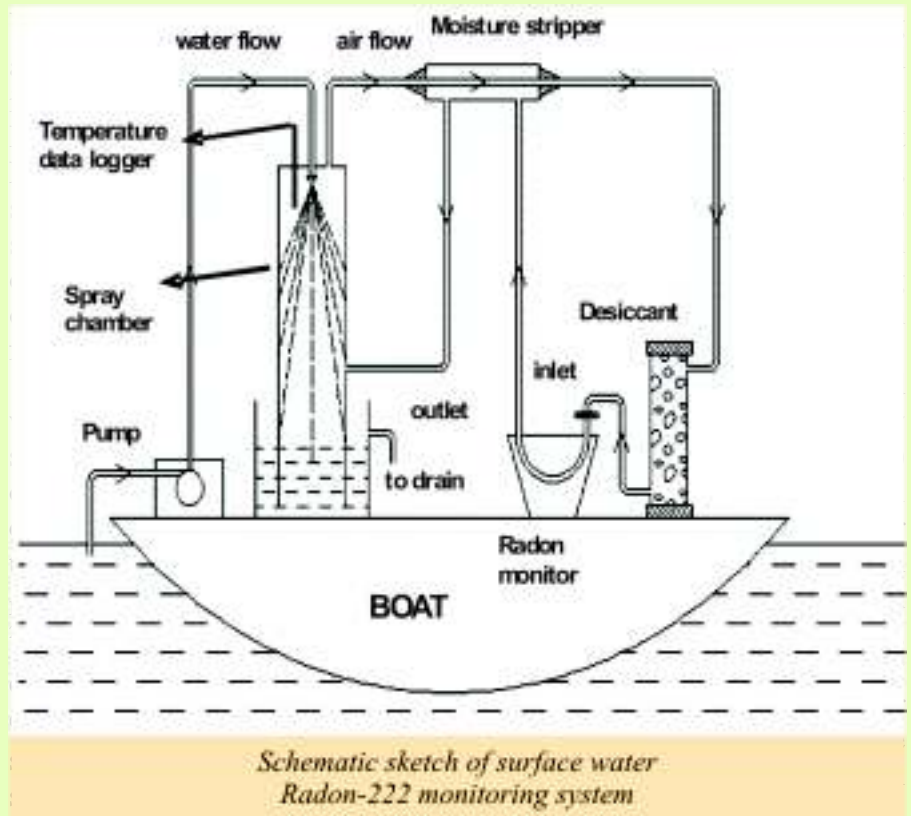

were also collected and analysed for  $^{222}\text{Rn}$ . SGD rates were directly measured in the seabed for the same duration using a seepage meter.

Hybrid Nuclear Desalination Demonstration Plant (NDDP) at Kalpakkam and the Multi-stage Flash (MSF) desalination



*Hybrid Nuclear Desalination Demonstration Plant (NDDP) at Kalpakkam. The plant is based on MSF-RO technology*



# Advanced Technologies and Radiation Technologies and their Applications



*Rural Adaptation of BARC Developed Community level*

demonstrated that such plants would help in dealing with the shortage of good quality water in water stressed coastal areas.

The product from MSF unit was high quality distilled water, containing <5ppm total dissolved

solids.

Low Temperature Evaporation (LTE) plant coupled to nuclear research reactor CIRUS has shown that waste heat temperatures even as low as 47°C can be utilized for seawater

desalination producing distilled quality water. The product water having 1-2 ppm TDS is used as makeup water in CIRUS. The next generation LTE plant of 50 KLD capacity integrated with electro-de-ionization (EDI) unit was demonstrated for producing ultra-pure (0.1  $\mu\text{S}/\text{cm}$  conductivity) desalinated water from seawater for high end applications. PLC based control system for the LTE plant was developed and incorporated in the system. To achieve near zero liquid discharge, experimental studies on rapid spray evaporation unit, were taken up on a lab-scale.

The barge mounted mobile seawater RO Desalination Plant of 50 kilo-litres capacity, developed by BARC, was registered under the name 'SUJAL' (No. M - 7708).



*Solar PV driven UF unit water purification units in a village without Electricity*

# Advanced Technologies and Radiation Technologies and their Applications

An MOU on custody and operation of this plant was signed with IRE.

A next generation UF based iron removal unit, developed by BARC, was deployed at CGCRI, Kolkata for field testing. It produces safe drinking water (with less than 0.3 ppm iron content as per WHO) from contaminated water having iron level upto 6 ppm. Tubular ceramic (silica) membrane on titania support having average pore size of 1.6 nm and surface area of about  $60 \text{ m}^2/\text{g}$  was developed. Positively charged nanofiltration thin film composite (TFC) membranes were developed on lab scale for effluent treatment and trial runs are taken up. Bipolar electro dialysis cell was developed for studying ammonium nitrate splitting. Technologies of back-washable spiral UF module and arsenic removal unit for water purification were transferred to private parties for wider

deployment.

In order to deploy water treatment technologies in un-electrified remote areas, UF units of 100 lph & brackish water RO pilot plants (200 lph), driven by electricity produced through solar photo-voltaics (PV) were designed and developed.





# Chapter : 5

## Basic Research

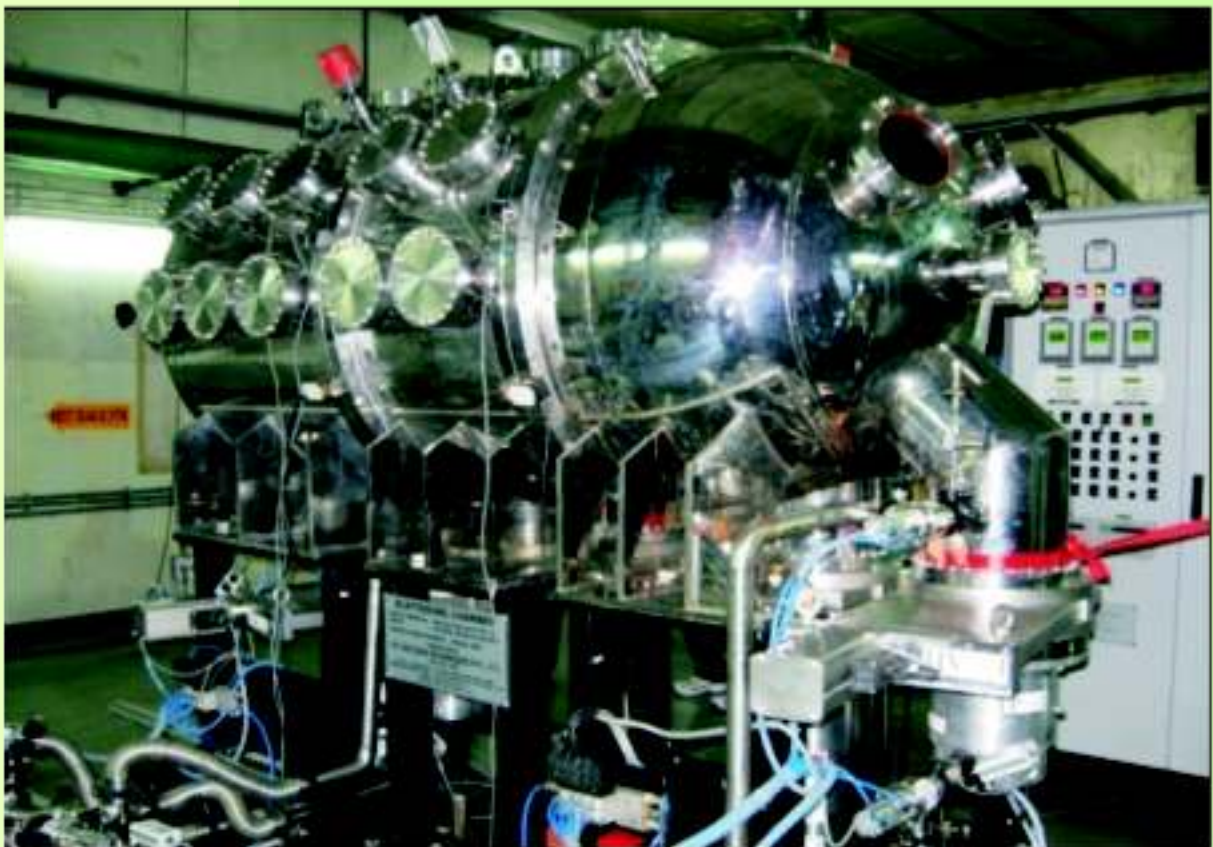

*Segmented Reaction Chamber at Super Conducting Cyclotron experimental hall at VECC, Kolkata*

# Basic Research

The research centres of DAE are engaged in basic research in the areas relevant to the programmes they are pursuing. In addition, the autonomous research institutes, supported by the grant-in-aid by DAE, are engaged in frontline basic research that ranges from mathematics to computers, physics to astronomy and biology to cancers. During the report period, following were the major activities of these organizations in basic research.

## MATHEMATICS & COMPUTATIONAL SCIENCE

Two computing clusters with a performance rating of 700 GFLOPs and 1.4 TFLOPs were built for supercomputing technology evaluation. The new supercomputer, with estimated

performance of over 30 TFLOPs, will go on-line in 2010. An energy efficient heat removal system was designed for the machine. A smaller 1 TFLOP computing cluster was commissioned for specific High Pressure Physics applications.

BARC has developed a solver software “AnuPravaha” for computational fluid dynamics to create a finite volume based solver to solve Navier-Stokes and associated scalar equations to be used for engineering applications.

As a part of security systems, advanced entry control system was developed and installed at BARC gates for authentication of employees as well as of visitors. RFID based system also doubles as time and attendance system. Secure access was provided from DAE's wide area network ANUNET to BARC Technology

Synergiser, On-line Confidential Reporting and the Parinay system for linking of resources, people and programmes.

A hi-tech multimedia conferencing system was set up for multi-site scientific conference events with remote and centralized control features.

Programmes And Resources INtegrAtion sYstem (PARINAY), is a web based application for integrating scientific staff, facilities and the scientific programmes establishing proper linkages. The first phase of development of PARINAY system was completed and it has been made operational.

A web based On-line Confidential Report (OCR) system was developed and made operational for the second successive year for the scientific officers of BARC for submission

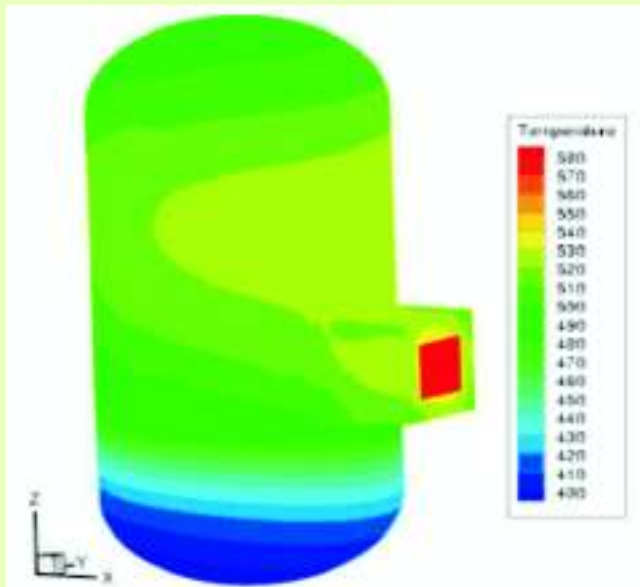

*Temperature distribution throughout the vessel of heat exchanger*

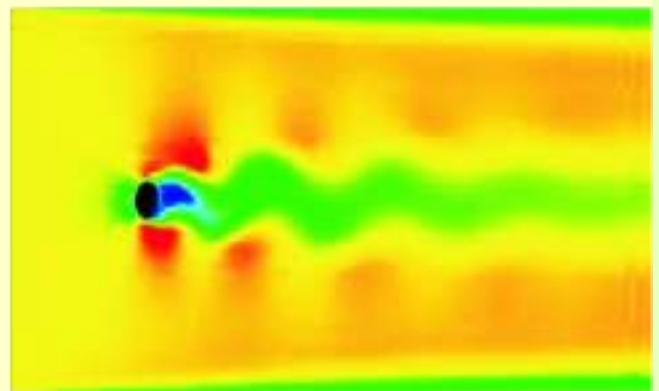

*Vorticity contours in the fluid due to oscillating cylinder*

## Basic Research

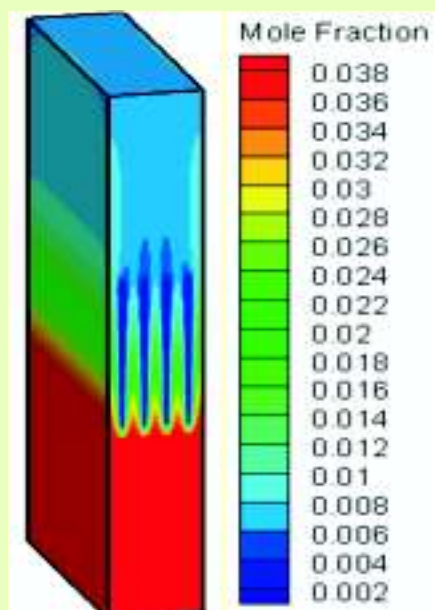

Hydrogen Mole Fraction Contour  
( $X_{H_2 in} = 4\%$ ,  $T_{in} = 25^\circ C$ ,  
 $V_{in} = 0.5 \text{ m/s}$ )

of their CRs. The feed back on the use of this system was obtained from users and work on making improvements in the system was in progress.

BARC was actively participating in setting up National Knowledge Network (NKN), the national network infrastructure being set up by Government of India to establish high speed connectivity among the R&D and academic institutes of India. NKN would enable the use of specialized applications which allow sharing of high-performance computing facilities, e-libraries, Virtual classrooms and very large databases spread across the geographical expanse of our country.

Specific finite volume based in-house computational fluid

dynamics (CFD) code was developed to model and analyse the working of Passive Catalytic Recombiner. 3D CFD computations were performed to study the mechanism of catalytic recombination and were used to simulate a literature reported benchmark experiment. Parametric study was performed for particular recombinder geometry for various inlet conditions.

CFD computations were performed to investigate the dispersion of  $SF_6$  over terrain of KAPP using the actual meteorological data. Three-dimensional, transient simulations were carried out using CFD code. Atmospheric dispersion in presence of the structures like Reactor Building, Natural Draft Cooling Tower and Turbine Building was studied. A model was used to simulate the transport of  $SF_6$  for 72 hours.

CFD analysis of the flow inside a high pressure hydraulic valve was carried out using commercial CFD code CFD-ACE to capture the cavitation phenomenon inside the valve.

Sensitivity and uncertainty analysis of the migration of water borne radionuclide through a geological repository was studied using Polynomial chaos theory. Robinson-Hodgkinson (R-H) risk model was investigated using polynomial chaos theory. A study on uncertainty analysis of Strontium-90 retention function using polynomial chaos theory was carried out. Trend analysis of

time series was studied using Mann-Kendal test. Kruskal-Wallis test, was applied to carry out the Analysis of variance (ANOVA) test. Both these tests were applied to investigate the statistical fluctuation of the activity due to Cs-137, Sr-90 and Tritium (H-3) in the borehole water samples collected at CIRUS - DHRUVA complex. Numerical method for computing the concentration of radionuclide in mother's milk and corresponding ingestion dose to infant was developed by adding two more compartments in the existing Biokinetic model. In order to validate this method, a case study considering the Biokinetic model of I-131 was applied for computing ingestion dose due to an ingested activity of 1 Bq. Soft computing technique based on Fuzzy Vertex Method was developed for computing imprecise probability associated with radiological risk model. Radiological risk due to inhalation of contaminant air and ingestion of contaminated food was considered for this study. Imprecise probabilities associated with time integrated air concentration due to the uncertainty of wind speed and the source term was computed using the soft computing technique.

During the report period, VECC completed its project relating to Advanced Computational Facility.

To facilitate the communication between the hearing-impaired persons and



# Basic Research



*User Interface of the software with a typical input text (in Bangla) and its corresponding signing*

normal hearing people, VECC initiated a collaborative effort with Webel Mediatronics Ltd, Kolkata for the development of a software that will convert the sign language to Bangla text. Preliminary level developments like recognition of different body parts (head, land, arm, elbow etc) in static frames and basic hand movements in a movie clip, were made. It will act as a teaching aid and also help in the development of language skills of deaf children.

The activities of the TIFR, during the report period, were as under:

- The existence of a Harder-Narasimhan stratification of parameter schemes in a family of pure sheaves on a projective fibration was proved. A moduli

scheme for unstable rank two bundles of a given Harder-Narasimhan stratification on a curve was constructed.

- Properties of certain simplicial complexes associated to a ring, whose homotopy groups map to the algebraic K-groups of the ring, fitting into a long exact sequence were established. It was shown that the Chow group modulo 1 of a generic abelian 3-fold is infinite, for all but finitely many primes  $l$ .
- Explicit solutions for a system of partial differential equations modelling large scale structure formation in the universe were constructed. These solutions contain delta measure concentrated on shock waves and vacuum states in rarefaction region.

- Smooth numbers in short intervals were investigated unconditionally as well as on the assumption of the Riemann hypothesis.
- Weyl modules were constructed in the generality of Loop Kac-Moody Lie algebras and certain tensor product decomposition proved.

It was shown that a stably free projective module of rank  $(d-1)$  over a nonsingular affine algebra  $A$  of dimension  $d$  over an algebraically closed field  $k$  is free, provided  $(d-1)!$  is a unit in  $k$ . This settles a conjecture of A. Suslin made in his ICM talk at Helsinki in 1978.

At TIFR, ongoing work included stochastic control and optimization covered risk-sensitive control, singular perturbations, resource allocation algorithms for communication networks, stochastic approximation schemes for infinite dimensional optimization problems.

Work was carried out in developing techniques and tools for sampling and digitization based methods for the analysis of dense time temporal logic properties.

Embedded systems laboratory infrastructure was enhanced with software tools and firebird education robots.

Progress was made on obtaining algorithms and showing lower bounds in the areas of Graph Algorithms, Computational Geometry, Computational

## Basic Research

Complexity and Quantum Computing.

Contributions were made in the areas of classical and quantum information theory.

In the area of programming languages new constructs for dealing with multi-core architectures were designed and formally analysed.

During the year of report, the Institute of Mathematical Sciences (IMSc), Chennai, continued its research programme in mathematics in addition to post-graduate and doctoral level thesis works. The qualified thesis work was submitted to the Homi Bhabha National Institute of DAE for award of PhD degrees. The Institute remained engaged in the research projects as follows :

- India based Neutrino Observatory Project, that has finished the pilot stage, identified site and is awaiting some environmental clearances.
- Tsunami analysis modeling jointly with National Institute of Oceanography, Goa.
- PRISM-Simulation and modeling of diverse phenomena.
- Indo-French centre for promotion of advanced research in physics, mathematics and theoretical computer science.
- Cell response to parasites supported by the Department of Bio-Technology.
- Algorithms, Complexity, Automata and Logic.

- DST-DAAD project on parametrised algorithms jointly with University of Jena, Germany.
- Non-Commutative geometry.
- Cryptography.

Apart from regular teaching in Mathematics, the National Institute of Science Education and Research (NISER)'s Mathematics Faculty remained engaged in diverse frontier areas of research in both pure and applied mathematics. A PhD programme in Mathematics will also be introduced.

To cater the need of both theoretical and experimental research, a high performance Super-Computing Facility will be established at the Institute shortly.

In the field of Mathematics, following were the major activities of the Harish Chandra Research Institute :

Classification problem of the finite dimensional irreducible integrable representations of the Lie Tori  $sl(n+1, \mathbb{C}_q)$  was solved, where  $C_q$  is the quantum tori associated to the  $n \times n$  matrix  $q$  of non-zero complex numbers with the some conditions on the entries of  $q$ . In a joint work with Mazorchuk, for Lie algebras with triangular decomposition, a family of simple Whittaker modules were constructed and their annihilators were described.

If  $G$  be a finite group and  $M(G)$  denotes the subgroup generated by the conjugacy classes having two smallest lengths. The problem

of determining the nilpotency class of  $M(G)$  was studied. The results obtained in this study, generalised the recent results of Martin Isaacs. In a joint work with Mahender Singh and I.B.S. Passi the problem of extending the automorphisms of an abelian subgroup  $N$  (of a group  $G$ ) to the automorphisms of  $G$  and lifting the automorphisms of  $G/N$  to the automorphisms of  $G$  was solved.

Research continued in geometric prequantization of moduli spaces for example the case of non-abelian vertices was completed. Work also progressed in the area of astrophysics using some mathematics to prove multi-transonicity in black-hole accretion.

Work was completed on an uncertainty principle on the Heisenberg group, in spirit of the classical Benedick's theorem. From a general view point, an uncertainty principle essentially say that a function and its fourier transform cannot both be highly localised. In a joint work, the result obtained is that if  $f$  is compactly supported square integrable function on the Heisenberg group, and the Heisenberg fourier transform is a finite rank operator, then  $f$  has to be identically zero. Analogous results (in terms of rank) do not hold on other lie groups, for instance in the case of Euclidean space, or rank one semi-simple lie groups.

In another joint work, the

# Basic Research

analyticity problem for the solutions of the Schrodinger equation on the Heisenberg group was solved.

Work continued on certain topics in real algebraic geometry, including vector bundles over real abelian varieties. Certain other questions on vector bundles over real algebraic curves were also under investigation.

During the report period, work was completed on the topic "Mapping Class Groups of the powers of long ray and some nonmetrizable manifolds". Another problem on the topic "Inverse limit system of nonempty objects with nonempty limit" was solved.

An orthogonality relation for the Artin-Schreier pairing on a local function field was proved. For a local number field not containing a primitive  $p$ -th root of 1, where  $p$  is the residual characteristic, the space lines were determined, which parametrise cyclic extensions of degree  $p$ . Together, these two results completed the determination of the maximal  $p$ -elementary abelian quotient of the absolute Galois group of a local field of residual characteristic  $p$ , along with its filtration.

Researchers at HRI pursued investigated in various areas of Number Theory.

Optimal lower bounds were obtained for the number of rational numbers representable as ratios of integers from a pair of large but otherwise arbitrary

subsets of the intergers in a given interval. The bounds are in terms of the densities of these sets in the interval. A final version of a study of the diameter of sets of triples of integer points on conics together with a certain analog of this study for diagonal quadrics in higher dimensions was completed. A preliminary version of this work was reported in 2008.

Work progressed around some open problems on additive combinatorics and transcendental number theory.

Using the actual calculation of the density of set of primes, the explicit degree of multiquadratic number field was calculated. Also, it was proved that some real numbers which have aperiodic decimal expansion are transcendental numbers.

A characterization of the space of newforms of half-integral weight under the Atkin-Lehner operator was studied. As an application, interesting congruences are obtained for the number of representations of  $p^2$  as a sum of an odd number of integer squares. A relation is obtained between the values of a certain sequence of modular functions on genus zero subgroups of the full modular group (which are derived from the classical  $j$  function) and arithmetic of the coefficients of modular forms on the full modular group. Further, an explicit description of the action of Ramanujan's theta-operator on modular forms, universal

recurrences for the coefficients of certain meromorphic modular forms and an identity for the exponents in Borcherds infinite product expansions were obtained. In another research work, the pseudo-eigenvalues of the Atkin-lehner  $W$ -operators on newforms of half-integer weight were obtained by expressing them in terms of the Fourier coefficients of the corresponding forms of integral weight.

Various questions relating to the class number of number fields were pursued and some interesting results were proved. Work relating to several questions on special functions is in progress and some results were obtained on this topic. Work relating to questions on non-vanishing of  $L$ -functions associated to automorphic forms and its possible applications is in progress. The concept of modular symbols over quadratic fields was studied in this regard.

## PHYSICS

Operating at a threshold of 1.5 TeV, the TACTIC telescope at Mt.Abu continuously monitored the activity from active galactic nuclei. Radiative lifetimes of zirconium atom and electronic structure of scandium nitride were studied using supersonic molecular beam facility. A 30 GW/500 ps Nd: Glass laser system was used to generate and study high temperature (500eV) and high density



# Basic Research



*A diamond anvil cell with Be backing plates*

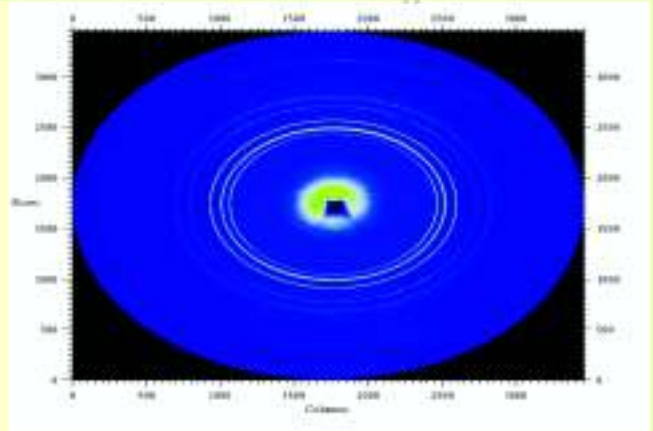

*Diffraction pattern with Be bases displaying full diffraction*

( $10^{22}$  electrons/cc) plasmas from a variety of targets. Using a novel technique, deep sub-barrier cross sections (as low as 100 nb) were measured for the first time for a weakly bound projectile ( ${}^6\text{Li}$ ) interacting with  ${}^{198}\text{Pt}$  target, using the Mumbai Pelletron facility. The National Facility for Neutron Beam Research at DHRUVA reactor was utilized for experiments on a variety of multiferroics, soft matter, biological and engineering samples. Magnetism and the origin of ferroelectricity in the multiferroic  $\text{MnWO}_4$  were studied using ab-initio electronic structure calculations and X-ray absorption spectroscopy. The calculations correctly reproduce the magnetic ground state of  $\text{MnWO}_4$ . A double-focusing neutron monochromator was installed in the Filter-Detector spectrometer at DHRUVA reactor resulting in increase in neutron flux for experimental studies of dynamics. A new diamond anvil cell using Be

as backing plates (instead of tungsten carbide) was fabricated.

A high-pressure, high-temperature two-phase flow meter was developed for measuring transient steam-water flow rates using gamma ray attenuation technique in conjunction with ventury. The flow meter was developed under a tripartite MoU among BARC, BRNS and Fluid Control Research Institute, Palghat, Kerala.

A high temperature Liquid Metal Loop (LBE) with Lead Bismuth Eutectic as the working fluid of the loop was commissioned in BARC. Steady state and transient thermal hydraulic experiments were carried out in the loop. Comparison of start-up and steady state experimental data with code prediction was also carried out.

Studies using different nanofluids such as  $\text{Al}_2\text{O}_3$ ,  $\text{CuO}$ ,  $\text{TiO}_2$  and  $\text{SiO}_2$  carried out for their thermal expansion characteristics revealed that the nanofluids have

much larger volumetric expansion due to rise in temperature as compared to water. Experiments were conducted with supercritical carbon-di-oxide at different powers and pressures for different orientations of heater and cooler and the same were compared with predictions of the NOLSTA code.

Particle Image Velocimetry was used to obtain distribution of velocity and flow pattern in fluidic device of advanced accumulator



*Supercritical Natural Circulation Loop*

# Basic Research

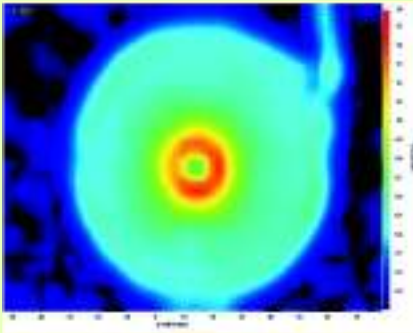

*Fluidic device distribution*

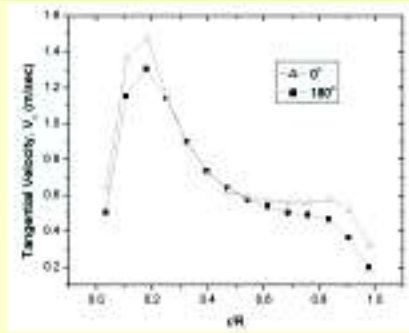

*Velocity contour from PIV tangential velocity*

of AHWR. Fluidic device, velocity distribution in fluidic device and tangential velocity profile are shown in the figures.

Development of a high precision 6-axes parallel manipulator for a wide range of applications, like supporting the optical instrumentation in synchrotron beam lines was initiated. Kinematic simulation and force analysis was done, and on the basis of calculated forces, design and drawings are completed.

An eight channel Constant Fraction Discriminator (CFD) module was developed using indigenously developed CFD Application Specific Integrated Circuits (ASIC). It provides a power efficient solution and good timing resolution for physics experiments employing multiple detectors. Multi Channel Scalar instrument was developed for timing applications like half-life period measurement, fluorescence and phosphorescence decay time measurement, photon counting etc. It gives count rate of events as

a function of time with bin width of 50ns to 1.6ms.

A prototype 2-30 MHz, 300W RF power source was developed. The amplifier has extensive measurement and protection features. Two prototype B-10 lined gamma compensated ionization chambers with integral mineral insulated cables was developed and tested for B1, B2 reactor. One prototype ionisation chamber for gamma exposure dose measurement for RGMS project was developed and tested. Compact multi-electrode ion chamber with wide range measurement capability was developed for reactor instrumentation. A silver lined proportional counter for detection of pulsed neutrons was handed over to RRCAT, Indore.

The Superconducting Magnetic Energy Storage (SMES) is a highly efficient, fast and clean environment friendly attractive solution for the power quality and sag mitigation problems which also has a high power storage per unit volume. SMES stores energy

in the form of magnetic field by superconducting coil, cryogenically cooled. At VECC, design of 0.6 MJ SMES system was carried out and coil was fabricated in house. The cryogenic system for 0.6MJ SMES was already installed.

At TIFR, an effective time-independent potential was derived for a confined Brownian particle subjected to a rapidly oscillating space-dependent force. Significant quantum effects were found in the intermediate regime of damping.

The effect of heat bath coupling and confinement on dissipative diamagnetism in determining low temperature thermodynamics was demonstrated.

It was shown that nuclear relaxation measurements may be used to unambiguously detect long-range magnetic and crystalline order in electron gases in disordered semiconductor heterostructures.

The formalism for analyzing the collective neutrino oscillations for nonspherical sources, like coalescing neutron stars, was developed.

It was found that the present upper bound on the branching ratio of  $B \rightarrow \mu \nu$  puts strong constraint on the minimal supergravity parameter space.

The location of the critical end point of QCD was determined to the highest accuracy ever.

Work at TIFR continued on the relationship between long

# Basic Research

wavelength asymptotically AdS gravity and fluid dynamics, to include gravity in arbitrary dimensions, to fluids forced by varying background metrics and dilaton fields, and to the non-relativistic limit of fluid dynamics.

The moduli space and dynamical properties of 3-algebra field theories proposed to describe M-theory membranes, were obtained. The relation between membrane and D-brane field theories was exhibited and higher-derivative corrections to 3-algebra theories were computed using dualities and a novel Higgs mechanism.

## ***Astronomy and Astrophysics***

In the fields of Astronomy and Astrophysics, the work carried out related to design and fabrication of instruments for the first Indian astronomy satellite, ASTROSAT. Three of the X-ray instruments Large Area Xenon Proportional Counters (LAXPC), Soft X-ray imaging Telescope (SXT) and CZT Imager (CZTI) based on Cadmium Zinc Telluride detector. Some members are also involved in the UV Imaging Telescope (UVIT) reached in advanced stage of fabrication.

An instrument, with many novel features, to study solar X-ray, was launched on a Russian satellite in early 2009. This instrument is working properly and has detected some Gamma Ray Bursts.

In addition to the satellite based programmes balloon borne instruments were used to study X-ray and Infra-red radiation from a number of interesting sources. A near Infra-red spectrometer and Imager is being developed for use with current and future ground based Indian telescopes.

In theoretical astrophysics some of the important results obtained were: a) the discovery of one of the largest Einstein ring from the Sloan Digital Sky Survey data, which could be a first gravitational lensed system where random shear from many galaxies or groups of galaxies together with a dwarf spheroidal galaxy at very low redshift of 0.0375 act as the lensing object; b) developing a technique to determine radius of neutron stars using the Quasi Periodic Oscillations; c) study of variations in the star formation activity in globular clusters; confirmation of a massive red-sequence selected galaxy cluster at a red shift of 1.34; d) discovery of a supernova which did not yield a Gamma Ray Burst; e) discovery of an X-ray tail/jet from a new X-ray source from Chandra data, which was interpreted as a pulsar wind nebula based on multiwavelength observations; and f) estimate of magnetic field in the solar interior using even order splitting coefficients in helioseismic data.

At the National Centre for Radio Astrophysics of TIFR, the Giant Metrewave Radiotelescope (GMRT) software backend was

commissioned for all current observing modes at 32 MHz bandwidth. Brushless drive system and PC104 based controller (with BARC) was tested on one antenna, and projected extension to four antennas with RFI shielding and improved control characteristics. Feasibility study was carried out for a new digital backend multiplying the power of the Ooty Telescope by a factor of four.

Prototyping of DWDM broadband optical fibre link was completed, and phased installation in antennas will commence soon.

High level software developed in collaboration with partners in industry and astronomy relating to telescope control and monitor systems, scheduling and proposal handling for telescopes.

The work relating to tackling the problem of Radio Frequency interference, that is endemic at all radio observatories, , surveying electrical equipment in the vicinity of antennas with the help of the electricity board, and improving data processing, continued.

## ***High Energy Physics***

At TIFR, a new experiment in which ultra-cold Fermionic and Bosonic neutral atoms of Potassium and Rubidium can be trapped and studied, was set up to investigate atom-atom quantum correlations at the level of just two atoms in a laser optical trap.

Regular observations on Gamma ray Pulsars and AGNs



## Basic Research

continued, using the Telescope system PACT at Pachmarhi and HAGAR at Hanle (Ladakh).

CMS Detector at the Large Hadron Collider: Readout for the outer hadron calorimeter (HO) improved and prototype of alternative readout installed for on-board test.

D-Zero detector at Tevatron: A search for Charged Massive Stable Particles (CMSP) was completed using an integrated luminosity of 1.1 fb<sup>-1</sup>.

Belle Detector at the KEK asymmetric B-Factory: Silicon Micro-Strip detector development were continued. Single sided microstrip detectors characteristics were optimized.

### *Nuclear and Atomic Physics*

A compact particle-gamma coincidence set-up designed to perform horizontal spectroscopy of stable and neutron rich nuclei using projectiles having alpha cluster structures like <sup>7</sup>Li, <sup>9</sup>Be and <sup>11</sup>B. In-beam experiments were performed using this set-up.

The dipole magnet alignment was under finalisation and construction of beamline was in progress.

TIFR carried out one major experiment to study GDR decay from <sup>192</sup>Pt nucleus using existing high energy gamma ray set up and the 4pi spin spectrometer.

In-beam hyperfine interaction studies were carried out for (a) Magnetic response of Fe in XFe<sub>2</sub>As<sub>2</sub> (X=Ca, Sr and Eu) and K doped EuFe<sub>2</sub>As<sub>2</sub> (b) Hyperfine

field of <sup>19</sup>F in highly oriented pyrolytic graphite.

ECR ion source was installed on a newly built 400 kV deck along with Einzel lens assembly, analyzing magnet and RF amplifier.

Experiments using photodissociation of H<sub>2</sub>O<sub>2</sub> by UV laser beam to produce OH radicals followed by electron collision were carried out. The detailed dynamics of resonances in water completed.

In addition to first observations of accelerated neutral atoms from nanocluster plasmas, new finding on turbulence is deciphered for the first time in probing magnetic fields at relativistic intensities.

In the Nano-optics laboratory, we were successfully obtaining coherent, ultranarrow random lasing from a Rhodamine sample doped with ZnO nanoparticles.

### *Condensed Matter Physics*

At TIFR, the discovery of superconductivity in a completely new class of materials viz., REFeAsO<sub>1-x</sub>F<sub>x</sub> called iron pnictides, was reported.

The compound Nd<sub>0.75</sub>Gd<sub>0.25</sub>Rh<sub>3</sub>B<sub>2</sub> close to the zero magnetization limit exhibited two antiferromagnetic like transitions, concomitant repeated/multiple magnetic compensation behavior and a characteristic oscillatory magnetic response. Zero magnetization alloys with large spin polarization have potential use in spintronics.

High quality single crystals of

the new Fe based superconductor Fe-Te-Se was grown successfully.

Work at TIFR established that formation of Kondo resonance feature is a generic phenomenon in correlated system.

A new kind of insulating phase in 5d transition metal oxides where the density of states at the Fermi level is finite and exhibit temperature dependence similar to that of a metal, was an important discovery made at the Institute. Other activities included Investigations of the origins of in-plane optical polarization anisotropy in the absorption spectrum of GaAs/AlGaAs quantum wells, fabrication of AlGaN/GaN based UV photodetectors and organic-semiconductor blue light emitting diodes.

The THz Spectroscopy setup was made functional and many materials of interest were studied.

At TIFR, growth of non-polar AlGaN and InN semiconductors and core-shell nanowire structures was carried out and a high-precision method was developed to study the dynamics of two-uid interfaces using an optical tweezer and a phase sensitive detection technique.

LiNiBO<sub>3</sub> (Lithium Niobate) based IR-OPO (Infra Red Optical Parametric Oscillator) was commissioned at TIFR for doing IR-UV double resonance spectroscopy of hydrogen bonded complexes.

Experimental exploration of correlation between protein dynamics and solvent dynamics

## Basic Research

showed that both these dynamical modes were coupled to each other.

Investigations carried out related to amyloid protein aggregation on cell membrane and in the cytoplasm of living cells.

Synthesis, characterization of organic molecules and Ir complexes for electroluminescence, solar cells; and light emitting devices in organic electronics were carried out.

The research done has shown for the first time that the high-valent heme redox intermediates of thermostable cytochrome P450 enzyme can be generated by pulsed radiolysis technique, and characterized the species.

Extensive studies were carried out by TIFR on folding function relationships in different proteins, namely, HIV-1 protease, GED, Dyein light chain (DLC8), SUMO proteins.

TIFR described structurally closest member of lens - crystallins from *Methanosarcina acetivorans*, an archaea. The study suggested that the protein might be one amongst the primordial domains, which gave rise to lens crystallins.

Rapid NMR techniques were developed that speed up the acquisition of multidimensional NMR data by several folds and at the same time resolve chemical-shift degeneracy and render information about various chemical shifts and coupling constants with high precision.

New frequency and amplitude modulated radiofrequency schemes were developed for

better heteronuclear and homonuclear dipolar decoupling in solid-state NMR to enhance resolution and sensitivity of spectral lines of both rare spins, such as  $^{13}\text{C}$ , and abundant spins, such as  $^1\text{H}$ .

Successful synthesis of (a) 5% efficient dye sensitized solar cells, (b) calcium phosphate/aluminium composite nanostructures for drug delivery to fibroblast cells, and (c) Iridium complexes for triplet harvesting dopants in OLEDs, were carried out.

At the Institute of Physics, in the area of condensed matter physics, studies were made on phase transition in DNA. Recently discovered the fluctuation theorems were analysed for entropy production work and heat distributions. The scaling properties of surface fluctuations of sandpile models and self organized criticality (SOC) were studied.

In high energy physics, studies were made on (i) shape independent relation at Freshbach Resonance (ii) static solutions of a Generalized Discrete 4 Model (iii) explicit realization of fractional statistics in one dimension (iv) staggered and short-period solutions of the saturable discrete non-linear Schrodinger equation (v) Fermion wavefunctions in magnetized branes (vi) duality symmetry in Field theory (vii) analysis of flowing anisotropies in relativistic heavy-ion collisions, and others

Research in the theoretical nuclear physics was carried out on (i) nuclear reaction cross sections of exotic nuclei in Glauber model (ii) superdeformed and hyperdeformed states in  $Z=122$  isotopes (iii) influence of the symmetry energy on the giant monopole resonance of neutron rich nuclei (iv) proton flow in Pb+Pb collisions at 40 A.Gev energy (v) identification of Jets at RHIC energy (vi) nuclear matter and finite nuclei in effective chiral model etc.

Theoretical research work was also carried out in the area of quantum information.

In experimental condensed matter physics, some of the results obtained included :

(i) Observation of the effect of oxidation temperature on the photoluminescence of Sn nano particle embedded in  $\text{SiO}_2/\text{Si}$  (ii) enhanced ultraviolet emission from Si nanocluster (iii) saturation effects in high fluence heavy ion implantation (iv) low energy and implantation induced amorphization effects in Si (100) (v) observation of a surface plasmon resonance absorption peak in the UV range blue shifted by 1.1 eV from the uncapped Au nanoparticles.

A new and highly sensitive glucose biosensor were fabricated; Two class of quantum dot sizes were identified by GXR; Using  $\text{Sm}_{1-x}\text{Ca}_x\text{MnO}_3$  system, presence of pseudogap in the near Fermi level electronic spectrum of a CMR system was

## Basic Research

observed; Research was carried out on multiferroic materials; Studies were conducted on ion beam induced interface modification of Co/Cr/Pt multilayer thin films to tune their structural and magnetic properties, and Electronic structure of ZnO Nanoparticle was studied. IoP developed first in-situ temperature dependent dynamic studies using our TEM system. The results showed that a high aspect ratio silicides could be made.

In experimental high energy nuclear physics multiplicity distribution in proton proton collision was stimulated at LHC energies, K<sup>0</sup>- production in Cu+Cu and Au+Au collisions at = 62.4 and 200 GeV at star detection was analysed. The QCD equation of state was obtained with thermal properties of Mesons.

The School of Physical Sciences of NISER, besides teaching assignments, remained engaged in diverse research programmes in both experimental and theoretical physics.

Research collaborations with national and international experimental and theoretical research groups of the institutions such as IIT-Bhubaneswar, University of California (USA), Lawrence Berkeley National Laboratory (USA) and MILC Collaboration (USA), were initiated.

In the field of experimental high energy physics, NISER made efforts to join Compact Muon

Solenoid (CMS) experiment at the Large Hadron Collider (Geneva). The Plan to start a grid computing facility for CMS was under consideration of the Institute.

In the field of condensed matter, NISER continued setting up of Thin-film and Nanophotonics laboratory. Research in frontier problems in condensed matter physics on topics like phase transition in charged colloids, density functional theory, electronic and transport properties of nano structures continued at the Institute.

In the field of theoretical high energy physics, Institute's researchers remained engaged in areas like Lattices QCD, supersymmetric models and grand unified theory.

During the report period, the research activities of the Harish Chandra Research Institute in Physics were as follows :

Activities in CMP was in four broad areas of correlated electron systems, mesoscopic systems and quantum wires, spintronics and atomic clusters. In correlated electron physics, work was completed on the impact of B site disorder on phase competition and transport and also the hysteresis and switching effects that arise in the field response. Studies are being done on double perovskites where anti-site domain formation frustrates the emergence of long range order. A strong-coupling expansion for electron-phonon systems was under development. Research on junctions of quantum

wires focusing on normal-superconducting junctions, with Andreev reflection and crossed Andreev reflection were continued. A Classification scheme for renormalisation group fixed points of such systems based on the group structure was also being developed. Recently, research on topological insulators was started. In spintronics, spin transport in mesoscopic and nanosystems were under study, with a focus to develop a transport theory for systems with broken spin rotation symmetry. Certain conceptual problems and their consequences for spin transport were studied and further studies were continued. In atomic clusters, transition metal (TM) doped alkali clusters were studied in detail using first-principles density functional theory (DFT) methods. TM doped Ge clusters were also being studied. These were found to obey electron counting rules that could explain their relative stability. Studies were also performed on alkali metal thin films, and alkali metal oxides studying their magnetic properties. Research on bulk materials for hydrogen storage was recently started.

Intensive research programme was carried out in theoretical HEP. This was in connection with detailed studies with new physics models, neutrinos and the expected results at the Large Hadron Collider (LHC). The areas covered in this research include



# Basic Research

Grand Unified Theories (effective higher-dimensional GUT operators), leptogenesis (in GUTs with low intermediate scales), neutrino mass models (see-saw textures giving three massless neutrinos), understanding beyond the standard model (BSM) theories using neutrino parameters, Phenomenology of experiments using terrestrial neutrino beams, works on ultra-high energy neutrinos, supernova neutrinos, neutrino models and their testability at the LHC, diffusion of ultra-high energy neutrino fluxes and BSM, the role and detectability of the charm contribution to ultra high energy neutrino fluxes, neutrino mass hierarchy determination for  $\theta_{13}=0$ , the effect of strong interaction (quantum chromodynamics) at the LHC, the search for supersymmetry in nature with its various ramifications, new physics in the Higgs sector, theory and phenomenology of extra spacelike dimensions whose signature can be explored at the LHC, and alternative theories of electroweak symmetry breaking, including little Higgs models.

The India-based Neutrino Observatory (INO) is a multi-institutional effort aimed at building a world-class underground laboratory. Some of the members of HRI remained actively involved in the simulation and theoretical studies related to this experiment. The Regional Centre for Accelerator-

based Particle Physics (RECAPP), set up with DAE support under the current 5-year plan, developed as an active hub of activities related to high energy colliders. Several dedicated computers were procured, and facilities for specialised computation were set up. The centre initiated several collaboration meetings involving scientists both in India and abroad.

In astrophysics, HRI carried out research in the areas of high energy astrophysics and compact objects, cosmological dark energy, large scale structure formation in the Universe, reionization and the intergalactic medium, inflationary cosmology and the early universe, and different aspects of black hole physics and semi-classical gravity. In the area of high energy astrophysics and compact objects, behaviour of relativistic accretion close to the event horizon was studied to model the spectral signature of the black hole spin. The motion of halo particles in the off equatorial plane of the compact objects was analyzed to find the degree of chaos. The three body Hill problem in strong gravity was studied to observe the chaotic nature of the motion. The possibility that some of the observed recycled pulsars could actually be strange quark stars were investigated. In the field of dark energy, the perturbations in the scalar field models of dark energy and their scale-

dependence were studied. In the area of large scale structure formation, N-body simulations were used for studying galaxy formation. Simulations were used to make predictions about future surveys of neutral Hydrogen in distant galaxies. There is a case for detecting high redshift galaxies using the GMRT. The hyperfine transition of singly ionized Helium-3 was proposed as a probe of the high redshift universe. The physical processes related to the cosmological reionization, like star formation, chemical enrichment and feedback, were modeled. The comparison of these models with different observations was performed. Different methods of detecting signatures of reionization with low-frequency observations were investigated. In the field of inflationary cosmology, the generation of features in the primordial spectrum were under investigation in canonical as well as non-canonical scalar field models. Alternative scenarios for the generation of primordial perturbations were also under investigation. In the area of black holes, studies were performed on analytical aspects of black hole astrophysics and analogue gravity phenomena. In semi-classical gravity, the effects of modified dispersion relations on the response of non-inertial detectors in flat space-time were under analysis.

A major part of the work done

## Basic Research

by the String Theory group of HRI, was to understand the microscopic analysis of the quantum entropy functions of the black holes. A precise and first principle calculation of this is possible for the supersymmetric extremal black holes using string theory. An algorithm was developed to calculate the exact entropy of different types of extremal black holes. Also a thorough analysis was made between microscopic and macroscopic entropies of different types of black holes with identical near horizon geometries. It was identified how they differ only due to the degrees freedom living outside the horizon which is popularly known as black hole hairs. The path integral partition function of different types of blackholes with different dyonic charges were evaluated. A heat kernel method of calculating the Laplacian for the particles of different spins in the AdS3 space time was developed which enables one to calculate the propagators for quantum loops of gravities and supergravities. A Galilean limit of the conformal algebra was found which paves the way to analyse the Schroedinger's limit of the AdS/CFT duality. A covariant formulation of the Navier-Stokes equation for Galilean conformal algebra was also developed. Also AdS/CFT duality between Boltzman system and Einstein gravity was developed. A fast

evaluating procedure of S-matrix elements of different supersymmetric Yang-Mills theory was developed. A considerable progress has also been made in inflationary cosmology and pre-heating of the universe using D-branes.

In QIC field, HRI carries out research in the area of quantum computation and quantum communication, and their interface with many-body physics. In this field, the activities included on classical and quantum information transfer capacities of multi-access quantum channels, using quantum information techniques to solve many-body problems, and detecting quantum states in ultra-cold atomic systems by atom counting statistics.

At the Saha Institute of Nuclear Physics (SINP), which celebrated its Platinum Jubilee recently, carries out basic research in various fields of mathematics, physics, chemistry and biology. Institute's activities in these fields, during the period of report, have been described in this chapter under related subheadings.

The state of a black hole in loop quantum gravity is given by a distribution of spins on punctures on the horizon. The distribution is of the Boltzmann type, with the area playing the role of the energy. At SINP, the normal modes of a scalar field in the background of a warped black hole, which arises in topologically massive gravity, were studied. The flavour singlet axial Ward identity with

OsterwalderSeiler twisted mass Wilson fermion action were studied on a finite lattice. These studies provided important observations relating to Ward identity and Yukawa coupling of the Higgs with the fermion KaluzaKlein (KK) states. A full next-to-leading order (NLO) QCD corrections to diphoton production at the hadron colliders in both standard model and ADD model were also developed.

The hydrostatic pressure dependence of the order of ferromagnetic (FM) to paramagnetic (PM) phase transition in a  $(\text{Sm}_{0.7}\text{Nd}_{0.3})_{0.52}\text{Sr}_{0.48}\text{MnO}_3$  single crystal were reported. Signature of antiferromagnetic transition in the magnetocaloric properties of nanocrystalline  $\text{La}_{0.125}\text{Ca}_{0.875}\text{MnO}_3$  of average particle sizes 70 and 60 nm similar to its polycrystalline bulk form were observed.

The negative giant magnetoresistance (GMR) in the cubic intermetallic compound  $\text{TbPd}_3$ , which is largest (-30%) among the  $\text{Rpd}_3$  series of compounds, were reported. The sign of the observed magnetoresistance could be interrelated with the sign of paramagnetic Curie temperature, suggesting close correlation between the magnetotransport behavior and the nature of the magnetic exchange interaction. In non-equilibrium dynamics studies, a radial pattern of polarization was observed in a Fe-based (but not in a Ga-based)

## Basic Research

room-temperature ionic liquid (RTIL) on irradiation by a focused laser. Negative capacitance was observed in conducting polymer nanowires, which exhibited features of one-dimensional Wigner crystals, Negative capacitance theoretically predicted characteristic feature of a Wigner crystal.

The eigenstate energies of an atom increase under spatial confinement and this effect should increase the electron density of the orbital electrons at the nucleus thus increasing the decay rate of an electron capturing radioactive nucleus. It was observed that the orbital electron capture rates of  $^{109}\text{In}$  and  $^{110}\text{Sn}$  increased by  $(1.00\pm 0.17)\%$  and  $(0.48\pm 0.25)\%$  respectively when implanted in the smaller Au lattice compared to implantation in a larger Pb lattice. These observations were interpreted to be a result of the higher compression experienced by the large radioactive atoms in the smaller spatial confinement of the Au lattice. Magic islands for extra-stable nuclei in the midst of the sea of fission-instability were predicted to be around  $Z=114$ ,  $124$  or,  $126$  with  $N=184$ , and  $Z=120$ , with  $N=172$ . Whether these fission-survived superheavy nuclei with high  $Z$  and  $N$  would live long enough for detection or, undergo alpha-decay in a very short time remains an open question. To resolve this issue, alpha-decay half lives of nuclei with  $130 < Z < 100$  were calculated in a WKB framework

using density-dependent M3Y interaction with  $Q$ -values from different mass formulae. The high spin states of  $^{138}\text{Ce}$  were populated in the fusion evaporation reaction. The gamma transitions belonging to various band structures were detected and characterized using an array of five Clover Germanium detectors. The level scheme was established up to a maximum spin and excitation energy of  $23\text{hbar}$  and  $9.51\text{ MeV}$ , respectively, by including 53 new transitions. Signature of a new magnetic rotation band with 4 quasi particle structure was found in this work. Bakelite based single gap resistive plate chamber (RPC) detector was developed for the detection of cosmic ray muons, with long term goal to harness such detectors in a massive iron calorimeter for atmospheric neutrino oscillation experiment, such as the one proposed for the India based Neutrino Observatory. Performance of the detector was found by the SINP research team, to be enhanced through application of a silicone coating on the inner surface, demonstrated through stable operation with excellent efficiency for cosmic muon detection and good time resolution achievable in this class of RPC detector.

### CHEMISTRY

Heat treated ultrathin  $\text{SnO}_2$  films ( $\sim 15\text{-}20\text{ nm}$ ) prepared on quartz substrates were characterized by X-ray diffraction (XRD), X-ray photoelectron

spectroscopy (XPS), UV-visible spectroscopy, impedance spectroscopy and DC current voltage measurements. The fabricated film coated with interdigitated gold electrodes was tested for the gas sensing property through conductivity measurement. An automated gas testing facility for the measurement was developed in-house with provisions for gas injection/release, evacuation etc.

$\text{SnO}_2$  nanoparticles prepared through water-in-oil microemulsion of the aqueous phase of surfactant.

Polyaniline based electrochemical sensor was developed for detection of carcinogenic and neurotoxic insecticide, Lindane.

Using Microwave Plasma CVD technique, high quality and highly oriented CVD diamond thin films were grown on silicon wafer ( $1\text{-}5\text{ sq cm}$  area) and characterized by SEM, XRD and Raman Spectroscopy. Following annealing, chemical cleaning and contact metallization of these films on silicon wafers, the alpha detectors were assembled as heterostructure of Metal-Insulator-Semiconductor in SS mount using spring loaded back contact. Based on DC conductivity measurement, the detectors were tested for their alpha sensitivity using electroplated  $^{238}\text{Pu}$  source. They were found to give reproducible response in air medium.

The solubility of thoria in



## Basic Research

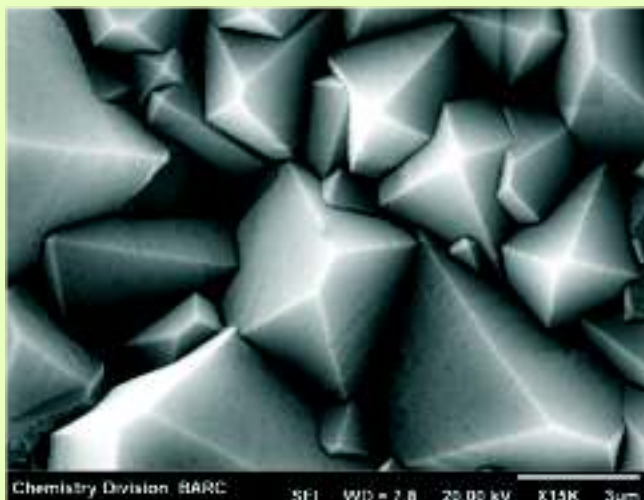

SEM Micrograph

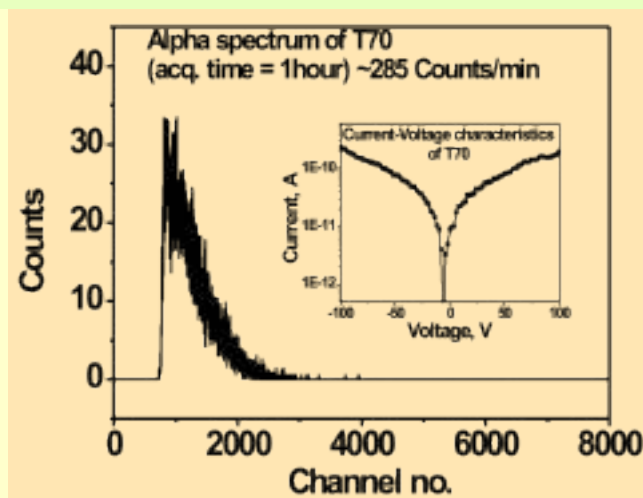

Alpha spectrum of typical CVD diamond film

$Gd_2Zr_2O_7$  pyrochlore could be enhanced by more than five times by simultaneous incorporation of alumina.

Nano crystalline magnesia-alumina mixed oxide ( $Mg_{0.80}Al_{0.20}O_{1.10}$ ) prepared by combustion synthesis was shown to be an excellent adsorbent for uptake of fluoride anion up to a certain concentration. Recent studies showed that lead can be effectively removed by ferrite nanoparticles. Pure and mixed oxides of iron were prepared in nanocrystalline form by combustion synthesis and were

studied for their sorption properties with respect to lead. The maximum sorption was achieved at a pH of 6 within 3 h. Newly developed sorbents were characterized by XRD, TEM, BET surface area, EDS and Zeta Potential etc. Performance of these materials was evaluated for flow characteristics in the column, purity and quality of daughter radionuclide for radiopharmaceuticals applications. A solvent based ZnO and TM doped (Co,Mn) ZnO nano-inks were formulated and used to obtain inkjet printed

patterns on various substrates like Si, polyimide etc in the form of highly crystalline c-axis oriented films (on Si) and patterns like dots, lines and junctions. These patterns were characterized for their magnetic and structural properties.

A large number of transition metal substituted compositions,  $BiFe_{1-x}MxO_3$  ( $x = 0.10$  and  $0.20$ ;  $M = Cr, Mn, Co$ ) investigated revealed that ambient temperature ferromagnetism is enhanced in this solid solution region retaining the ferroelectric properties. Water dispersible  $Gd_2O_3:Dy^{3+}(2\%)$



White luminescence from  $Gd_2O_3:Dy$  nanophosphors

## Basic Research

nanophosphors were synthesized through a facile polyol process and characterized by X-ray diffraction, transmission electron microscopy (TEM), Dynamic Light Scattering (DLS) and photoluminescence (PL) spectrophotometry. The resultant nanoparticles are single phasic and have spherical shape with 17 to 22% dispersibility.

Molecular recognition guided self-assembly was demonstrated by using cucurbit[8]uril (CB8) host and a benzthiazolium dye, thioflavin T (ThT), as guest.

Using Single-pair Förster resonance energy transfer (FRET) and photoinduced electron transfer (ET) concepts, the dynamical changes associated with double stranded (dsDNA) structures were investigated.

3,3'-Diselenodipropionic acid (DSePA) was synthesised and examined for *in-vivo* radioprotection at non-toxic doses. The compound was effective in protecting important radiosensitive organs like liver, spleen, and the gastrointestinal (GI) tract against lethal doses of radiation.

An indigenously developed Molecular Beam-Resonance Enhanced Multiphoton Ionisation-Time of Flight set up was employed for investigating the photodissociation dynamics of phosphorous trichloride ( $\text{PCl}_3$ ) and phosphorous oxychloride ( $\text{POCl}_3$ ) at 234 nm. The dynamical feature of the relative yield of atomic versus molecular chlorine elimination was addressed. These

studies have contributed in understanding a role of oxygen atom insertion in the photodissociation dynamics of a polyatomic molecule. In kinetics studies, temperature-dependent rate constants of OH with several pollutants were measured, and impact of these chemicals on the environment is assessed.

Type II CdTe/CdS core-shell quantum dot was synthesized to study the charge carrier dynamics using ultrafast transient absorption spectroscopy.

The syntheses of a series of calix-crown ethers, and homocalixarens with larger binding pockets were achieved. A O-alkylated calix-crown ether, synthesized indigenously showed excellent selectivity in complexing  $\text{Cs}^+$ -ion in the presence of other alkali and alkaline metal ions. An efficient and quick method for the synthesis of crown ethers, and a selective mono-O-alkylation protocol for calix[6]arene were devised under microwave irradiation.

The healing activity of black

tea extract and its major constituent, the theaflavins (TF) against the NSAID-mediated gastric ulceration in mice was established. TF showed better potency than epigallocatechin gallate, the major constituent of green tea. The diarylnonanoid, malabaricone C (from *Myristica malabarica*) showed excellent efficacy in killing human breast carcinoma MCF-7 cells through a caspase-independent apoptotic pathway. Its congener, malabaricone C showed significant anti-cancer property against human lung cancer cell lines, without being toxic to normal cells. Several synthetic resveratrol analogues were found to possess differential anti-cancer property against a large array of human cancer cell lines. Studies on the supramolecular interactions between electron donors such as porphyrins, phthalocyanines, calyx[5]arenes, and acceptors (fullerenes and their derivatives) revealed that the extent of host-guest complexation could be tuned by subtle changes in the molecular shapes and

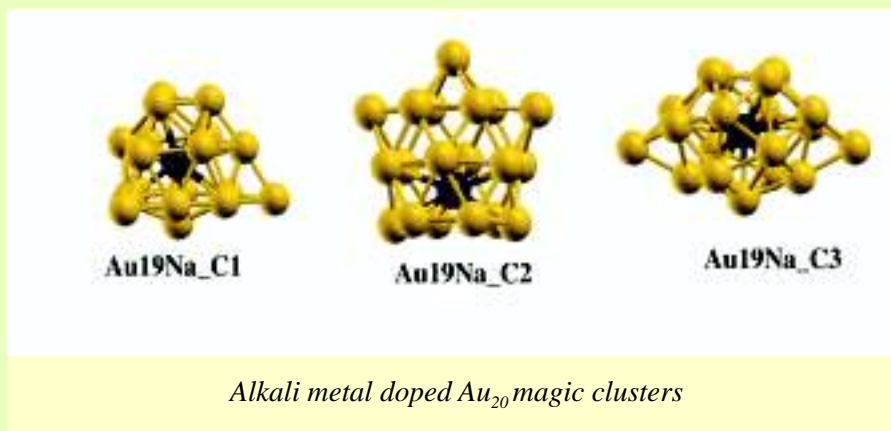

## Basic Research

electron densities of the donors. New pyrromethene laser dyes possessing oligoethyleneglycol moiety at the B centre was designed to improve the photochemical stability of this class of dyes. A new molecular rectifier was designed using a combination of porphyrin derivative and fullerene.

Theoretical studies on small size hydrated clusters of charged ions were carried out to elucidate their structure, stability and various spectroscopic properties to understand the microhydration phenomena and also to predict the properties of bulk hydration through extrapolation, for which a generalized microscopic theoretical approach was recently developed.

A facile closed system method for the preparation of high purity selenium (4-5 N purity) through the distillation of its chloride prepared using dry HCl and the reduction in glycerol medium was demonstrated.

Extensive ab-initio calculations were performed to (i) predict the structures and the electronic properties of alkali metal doped gold clusters.

Density functional and molecular dynamics simulations were carried out to predict the structure of polymers and other forms of soft condensed matter at interfaces. Theoretical development of the systematics of a framework for predicting the assembly of nano building blocks exhibiting rich morphologies were achieved. A theoretical

methodology was devised for the single chain simulation by combining the Monte Carlo technique and density functional theory for studying the structural properties of complex polymers and polyelectrolytes at different type of interfaces. This method was found to be successful for studying short polymer confined between parallel walls. A wide variety of new simulation strategies applicable to systems differing in length and time scales was developed.

A biocide liberating polymer was developed in which the polymer hydrolyses in water, creating a microenvironment conducive for the in-situ generation of chlorine dioxide from its precursor. Its effectiveness in terms of biocide release and microbial growth inhibition was demonstrated in laboratory trials.

Using “molecular imprinting” technology, which involves creating target-specific sorption sites within highly cross-linked polymers, a cobalt imprinted polymer was developed that can selectively pick up cobalt from a complexing medium, leaving behind the plentiful and largely non-active ferrous ions. The Co-60 virtually gets concentrated within a small volume, thereby accomplishing significant reduction in the active waste volume.

The phenomenon was demonstrated using two fluorescently labeled strains having green fluorescence protein

(GFP) and red fluorescence protein (RFP), which get expressed under different set of conditions. The information can be potentially used in microbially mediated degradation of organic pollutants.

Test facility is designed to house a PHWR coolant channel with associated feeder and first bend with full real time simulation of dimensions. Existing HTHP loop was modified to accommodate a small SG facility for studying the effectiveness of amines in sludge control under steaming conditions. New Data Acquisition System (DAS) was installed for high temperature and high pressure loop, tested and commissioned. Loop is now being controlled through the mimic panel of DAS.

Biofouling Test Loop Facility, a circulating seawater facility for carrying out experiments related to biodeterioration of materials used in cooling water systems, was made operational at Kalpakkam.

A new direct seawater intake system capable of continuously supplying 160 cum/h of clean seawater was commissioned.

A suitable remediation procedure to adsorb inorganic arsenic in ground water samples for consistently providing potable water with less than 10 ppb (the WHO/EPA limit) was developed.

Synthesis of silver and copper nano particles using naturally occurring chemicals (green chemistry initiatives) was standardized and their



## Basic Research



*Ti plate heat exchangers with heavy microbial fouling*



*Synthesis of Ag nanoparticles from AgNO<sub>3</sub> using gum kondagogu (*Cochlospermum gossypium*), a natural biopolymer*

applications as antibacterial agents established.

Studies on the purification of drinking water with respect to bacterial contamination using these nano-materials and sunlight were initiated. Accelerated dry ashing of biological samples using palladium nanoparticles was also studied.

A nano structured Mg/Pd material was developed which can hold about 6 wt% of hydrogen.

Programme on development of photo-catalysts for production of H<sub>2</sub> by splitting water under natural solar radiation was initiated. Studies were initiated with a composite of TiO<sub>2</sub> and polyaniline and with gold and Pt group metal dispersion within this composite.

A High Resolution Resonance Ionization Mass Spectrometer which consists of high resolution lasers and mass spectrometer, was setup. This is the second such facility in the world. The facility opens up possibilities like high resolution spectroscopy with

extremely small quantities of samples, detection of rare isotopes (for medical diagnostic applications), analytical chemistry and investigations on isotope selective photoionisation.

Studies on natural Rb having <sup>85</sup>Rb (major), <sup>87</sup>Rb (minor) isotopes were carried out.

A high performance liquid chromatography (HPLC) method was developed based on mandelic acid chelating agent for the pre-concentration and separation of uranium in seawater and process samples using C<sub>18</sub> stationary phase. The method offered quantitative recovery of U and linearity in the concentration range of 0.5 ppb to 500 ppb. The HPLC methodology was validated by comparing the results with those obtained by isotope dilution-thermal ionization mass spectrometry.

A novel method for accurate determination of <sup>11</sup>B/<sup>10</sup>B isotope ratios in samples containing a few

nanograms of boron was developed using negative ions.

A simple and fast method was developed for selective oxidation of UO<sub>2</sub> to UO<sub>3</sub> in (Th,U)O<sub>2</sub> solid solution using NH<sub>4</sub>NO<sub>3</sub>. UO<sub>3</sub> thus formed was selectively dissolved in 1M HNO<sub>3</sub> quantitatively. Thermal expansion behavior of Na<sub>2</sub>U(MoO<sub>4</sub>)<sub>3</sub>, Na<sub>4</sub>U(MoO<sub>4</sub>)<sub>4</sub>, UMoO<sub>5</sub>, UMoO<sub>6</sub>, Gd<sub>2-x</sub>Y<sub>x</sub>Mo<sub>3</sub>O<sub>12</sub> and Li<sub>2</sub>TiO<sub>3</sub> was studied using High-Temperature X-Ray Diffraction (HT-XRD). The enthalpy of transition from monoclinic to cubic phase of Li<sub>2</sub>TiO<sub>3</sub> was determined using DTA. Phase diagram for the Sr-Th-P-O system was established and three new compounds SrThP<sub>2</sub>O<sub>8</sub>, Sr<sub>7</sub>ThP<sub>6</sub>O<sub>24</sub> and SrTh<sub>4</sub>P<sub>6</sub>O<sub>24</sub> were identified.

Total reflection x-ray fluorescence / Energy-dispersive x-ray fluorescence (TXRF / EDXRF) methodologies were developed to determine Na, Mg, Al and Cd in uranium and for

## Basic Research

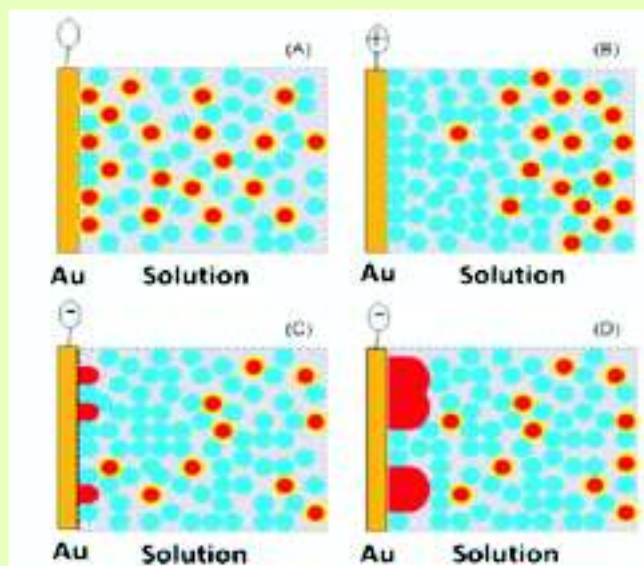

*Triple pulse strategy ;  
(A) at equilibrium, (B) during first pulse,  
(C) during second pulse and (D) during growth pulse*

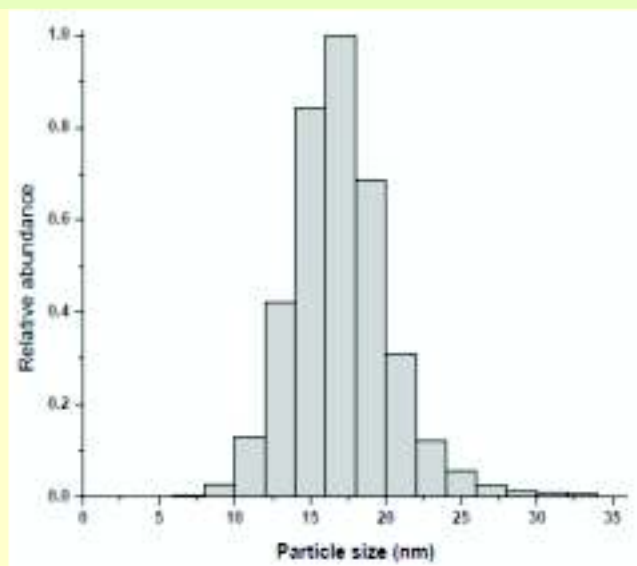

*Particle size distribution of the  
electrosynthesized lead nanoparticles  
using atomic force microscopy*

indium in heavy water.

Lead nanoparticles were synthesized on a template free gold surface from solution route at room temperature by employing a triple potential pulse strategy. The nanoparticles were characterized by anodic stripping voltammetry, XRD and XPS and were in the range of 1030 nm size as observed by atomic force microscopy.

Formation cross sections of projectile like fragments (PLFs) were measured in the reaction  $^{19}\text{F} + ^{66}\text{Zn}$  to understand their formation in the low energy domain (<7 MeV/nucleon).

Fission fragment angular distribution were measured in the reaction  $^{28}\text{Si} + ^{176}\text{Yb}$ , using  $^{28}\text{Si}$  beam from BARC-TIFR Pelletron-LINAC facility.

A photon induced positron annihilation (PIPA) facility was set up at FOTIA, BARC for

volumetric assay of defects in large engineering samples. Gamma rays (6-7 MeV) were produced by the reaction of 4 MeV proton on  $^{19}\text{F}$ . This facility with the methodology adopted is developed for the first time.

The collimated gamma rays were used to pair produce in the materials of interest and the Doppler broadening of 511 keV was measured. The measurements were carried out on polymeric rods, metal, deformed aluminium, cold worked zircaloy and metal pipes from ratcheting studies.

The k0-based internal mono-standard Neutron Activation Analysis (IM-NAA) method was validated by analyzing synthetic multi-element standards (SMELS) and IAEA reference materials and the Z-score values for most of the elements determined were within  $\pm 1$ . The

IM-NAA method using in-situ detection efficiency was used for large sample analysis, which finds application in analyzing non-standard geometry samples like archaeological artifacts, soil, coal and uranium ores and metallic alloys.

Extended X-ray absorption fine structure spectroscopy (EXAFS) studies of uranyl ion sorbed onto silica and alumina were carried out using the beam line BL-8 at Indus-2 to study molecular level speciation of uranyl ion.

Distribution Coefficient (Kd) values for U, Th, Ra and Po were measured from ground water and the soil of the area around the mill tailing ponds. U-233, Th-230, Ra-226 and Po-210 were used as tracers. A solvent extraction method was developed for the

## Basic Research

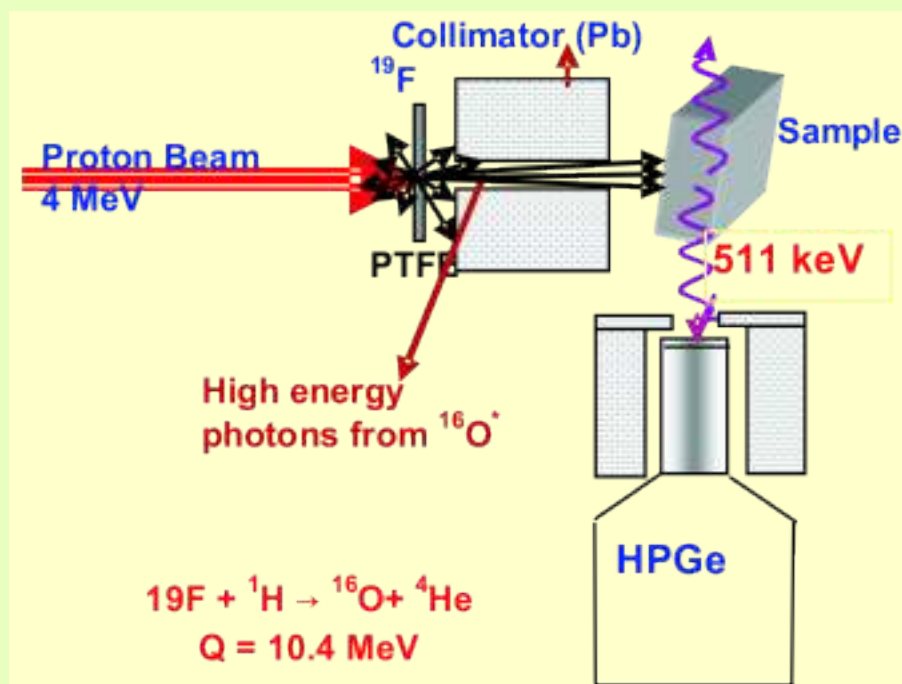

*Schematic of the PIPA Facility at FOTIA, BARC*

target, extraction of long-lived radionuclides Eu-152, Eu-154 and Cs-134 were achieved. These were a few amongst the many others studied.

### BIOLOGY

Extreme radiation resistance displayed by the nitrogen-fixing cyanobacterium *Anabaena* and *Deinococcus radiodurans* was studied. Key oxidative stress tolerance genes and DNA repair genes *Anabaena* were cloned, over-expressed, purified and their biochemical activities were characterized. Recombinant *Anabaena* strains over-expressing candidate genes were also constructed, with a view to enhance their stress tolerance.

DNA damage/repair protein Alr3199 is maximally expressed in *Anabaena* during stress conditions (a) and shows two interesting heme-erythrin domains of unknown function at the C-terminus. The corresponding gene was cloned from *Anabaena* and over-expressed and purified from *E. coli*. Biochemical characterization of purified protein revealed divalent cation-specific dual activities on double stranded plasmid DNA (c). Precise role of this novel protein in the stress biology of *Anabaena* is currently under investigation.

Studies on the response of *Anabaena* to thermal stress continued. A negative regulatory

quantitative extraction and stripping of Nd under High Level Waste (HLW) conditions.

A phenanthroline derivative containing triazine moiety similar to heme-BTBP was synthesized. A method was developed for chemical separation and determination of fluoride and chloride from High Level Liquid waste (HLLW) by pyrohydrolysis and Ion Chromatography. The composition of cover gas was determined first time by quadruple mass spectrometry and investigations were carried out on the release of gases as a function of temperature in  $\text{UO}_2$  microspheres and sintered MOX fuel pellets. Analytical methodology was developed for the determination of trace

amounts of Rare Earth Elements in Zirconium Dioxide, Zircaloy-2 & 4 and Zirconium 1% Niobium by Inductively Coupled Plasma Mass Spectrometry. Mixed Rare Earth-Uranium Oxides of the type  $\text{RE}_6\text{UO}_{12}$  (RE= Dy, Pr, Tb, Nd, Sm, Gd, Eu and La) and the compound  $\text{BaThO}_3$  were synthesized. A Differential Pulse Anodic Stripping Voltametric method (DP-ASV), for the analysis of Cd, Cu, Zn & Pb in Zircaloy-2 was established.

At SINP, methods for the separation of various radioactive elements were standardized and applied. Separation of Mo-99 and Tc-99m by liquid-liquid extraction, separation of no-carrier-added Tc-93, Tc-94, Tc-95 from Be-9 activated yttrium



# Basic Research

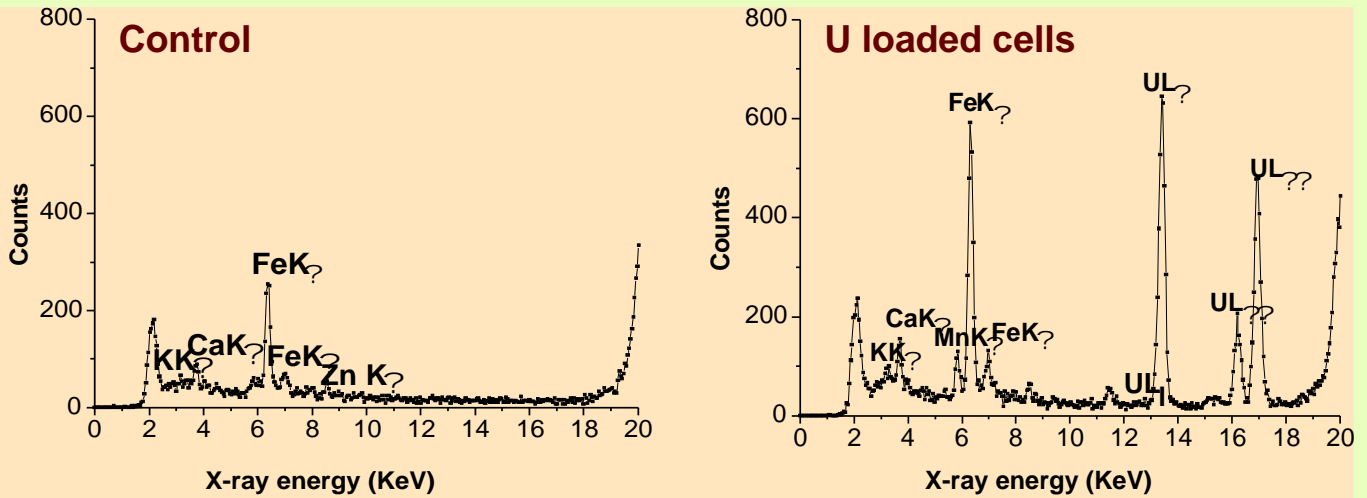

*Uranium sequestration by a marine cyanobacterium *synechococcus elongatus* from sea-water*

element CIRCE was identified in *Anabaena hsp60* gene promoters and the corresponding regulatory protein HrcA was cloned and purified from *Anabaena* for the first time.

A marine, unicellular cyanobacterium, *Synechococcus*

*elongatus* strain BDU/75042 was found to sequester U from simulated sea-water containing 100µM uranyl carbonate at pH 7.8. Organism could remove 72% (53.5 mg U g<sup>-1</sup> dry weight) of U from test solutions.

DNA damage induced signaling mechanisms leading to

DNA repair were characterized in the extreme radioresistant bacterium *Deinococcus radiodurans*. A DNA damage responsive membrane protein kinase, a two-component system of histidine kinase and its cognate response regulators were characterized and their roles in

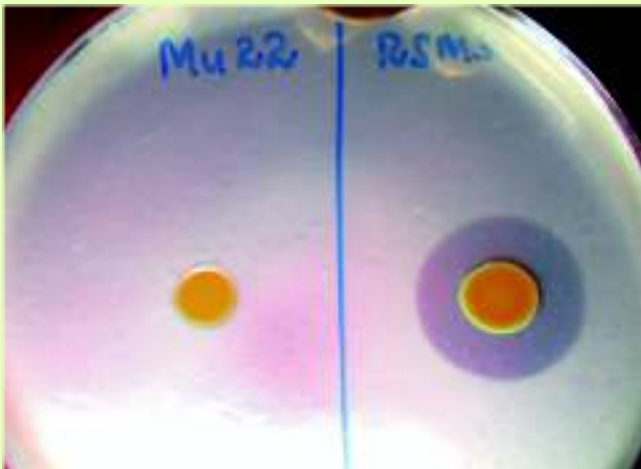

*Sphingomas* strain showing bio-degradation of tributyl phosphate (TBP)

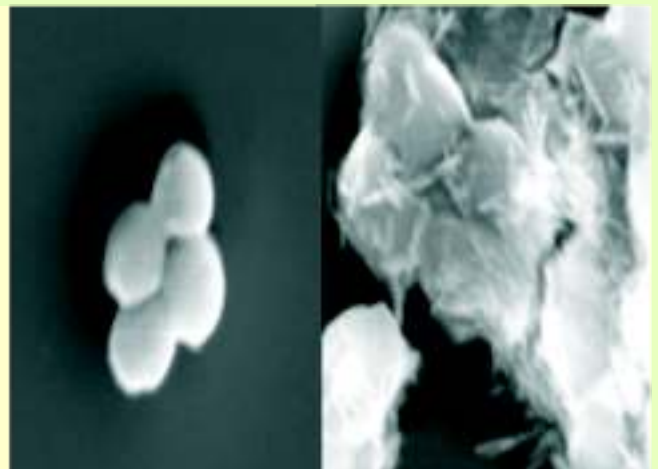

Scanning electron micrograph of genetically engineered *Deinococcus radiodurans* cells after bioprecipitation of uranium as uranyl phosphate

## Basic Research

radioresistance and DNA strand break repair of this bacterium were elucidated.

A DNA repair polymerase of *Deinococcus radiodurans* was characterized as a short-patch base excision repair enzyme, which is implicated to radioresistance of this bacterium. The SbcCD complex of *Deinococcus radiodurans* was characterized for Mre11-Rad50 type DNA strand break repair activities, normally reported from higher organisms.

Genetically engineered *Deinococcus radiodurans* when provided with a source of organic phosphate, could precipitate uranium from very dilute solutions (< 1mM) in radioactive environments within a few hours.

A tributyl phosphate (TBP) degrading bacterial isolate from the RSMS storage site was identified to be a strain of *Sphingomonas* using the molecular taxonomic approaches. The strain could grow in TBP (up to 100mM TBP), utilize it as the sole carbon and phosphorus source and appeared to degrade TBP to butanol and inorganic phosphate.

In order to understand the genetic basis of such novel capability of this strain, random transposon mutagenesis was carried out to obtain a null mutant.

Studies suggested that cAMP may be involved in the growth phase dependent regulation of *cspE* expression and the mechanism of this regulation was investigated by constructing and

using a *cspE*-gfp translational fusion. By following the both *cspE* promoter activity and translation levels during growth in wild type and *crp*<sup>-</sup> strain it was found that the growth phase dependant variation in *cspE*/*CspE* levels could be due to CRP dependant regulation.

Studies showed that N-Acetyl-L-cysteine (NAC) and L-cysteine and glutathione decreased the sensitivity of *E.coli* cells to a m i n o g l y c o s i d e and fluoroquinolones. These findings shows that GSH or its precursor thiols in general is an important determinant of antibiotic susceptibility for the bacterial cells. This study assumes importance as NAC is one of the smallest drug molecules in use.

Molecular evolution of 5S rRNA gene region from 15 species of subgenus *Vigna* (African *Vigna*) was investigated.

A simple procedure to extract pure phycocyanin from *Synechococcus* was developed.

At TIFR, the Moonlighting Functions of a glycolytic protein, Enolase from the malaria parasite *Plasmodium falciparum*, were studied. One of the organelles with which TIFR team observed stage specific association of enolase, is 'Food Vacuole'.

Gene discovery: In the attempt to identify all gene products necessary to facilitate reorganisation, TIFR initiated two different RNA interference based genetic screens. Of approximately 350 genes screened so far, researchers already have 31

candidates that perturb reorganisation when mutated, of which 25 have not been previously characterised.

Precise mechanistic details of molecular motor function during bidirectional motion of endosomes were established. It was shown as to why the two major microtubule motors (Kinesin and Dynein) are designed differently in nature

The research at TIFR identified specific noradrenergic receptors that contribute to the stem cell regulation in the adult mammalian brain, and demonstrated their relevance to the effects of antidepressant treatments. Also specific gene targets were identified for environmental perturbations in early life that persist well into adulthood, in particular changes in 5-HT2A receptor mediated signaling in the medial prefrontal cortex and in BDNF in the hippocampus.

Examination was done on the regulation of the neuron-glia "switch", a mechanism by which precursors in the brain decide to produce neurons versus non-neuronal cells. Evidence exists for a complex genetic interaction between two powerful regulators of development, transcription factor *Lhx2* and signaling molecule *Notch*.

It was observed that UV-inducible protein (UVI-31) from *Chlamydomonas reinhardtii* has three important functions when over expressed in *E.coli*: a) Induces round cell morphology and biofilm formation (Bol

## Basic Research

domain), b) UV-induced DNA damage repair protection against UV, and c) Beta-lactamase function.

Sexual dimorphism in Indian malaria patients were documented for both *P. vivax* and *P. falciparum* malaria.

At the National Centre for Biological Sciences, Bangalore, the work on polypeptide folding and unfolding puzzle yielded extremely interesting results : while evidence for a barrier-less folding reaction had been obtained, and a similar landscape was demonstrated for the unfolding reaction.

New DNA nanoprobe were developed as sensors of cell physiology (pH), and DNA nanospheres were synthesized as encapsulating nano-delivery systems.

New mechanisms involving the TOR signaling pathways by which survival cues integrate with molecules regulating T-cell differentiation and function were identified.

Different aspects of hematological diseases like thalassaemia, leukemia and neurological diseases like

Huntington's disease (HD) and Alzheimer's disease (AD) were studied by the SINP's researchers. Involvement of glycoconjugates in eryptosis observed in hereditary spherocytosis and thalassemia was established. Fluorescence quenching method used over the years to study interactions hemoglobin derivatives with erythroid spectrin was reviewed. Altered trafficking of AbetaPP (cleaved product of APP that involves in Alzheimer's disease) was shown to be due to interaction of Grb2-AICD.

In continuation of earlier observations that HIPPI is a transcription regulator, it was shown that for transport of HIPPI into the nucleus HIP-1 was necessary and a specific domain of HIPPI could interact with promoter. Crystallization and preliminary X-ray analysis of Psu, an inhibitor of the bacterial transcription terminator Rho, was reported. Structures of cyclophilin from *Leishmania donovani* bound to cyclosporin at 2.6 Å resolution and human lymphoid tyrosine phosphatase catalytic domain and NP24-I were solved.

Various inhibitors targeting

chromatin modulation were characterized. Mechanism of inhibition of alcohol dehydrogenase by mithramycin and chromomycin A3 was established. Interaction of Oxycam NSAIDs with lipid monolayer and non-steroidal anti-inflammatory drug induced membrane fusion were also studied. Akt and ERK1/2 pathways were modified, oxidative stress induced apoptosis like cell death in *Entamoeba histolytica* and heat stress induced induction of Hsp70 as well as manganese superoxide dismutase were observed. Human J-domain containing co-chaperone Mrj expresses differentially in different stages of cell cycle and localized in nucleolar region.

Photoinduced electron transfer probed by magnetic field effect to probe interaction of proflavin with aromatic amines in homogeneous and micellar media, interaction of quinones with three pyrimidine bases by laser flash photolysis, mechanism of electron transfer between DNA and a ternary copper complex, comparative study with adenine and 2-deoxyadenosine to find out the role of sugar, were investigated. Inhibition of lipid peroxidation and protein glycosylation by binding of the bioflavonoid robinetin with model membranes and hemoglobin was studied. Enhanced orbital electron-capture nuclear decay rate in a compact medium was observed. PEDOT-DBSA-Fe<sub>3</sub>O<sub>4</sub> conducting nanocomposite was synthesized

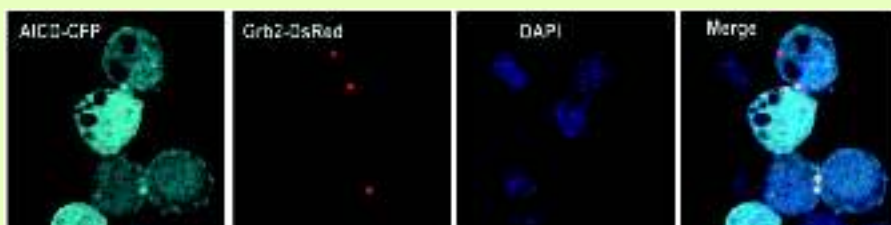

*CFP fusion construct of AICD (AICD-CFP) and DsRed fusion construct of Grb2 (Grb2-DsRed) were cotransfected in Neuro 2A cells. Their colocalisation is shown by white arrows in the merge image. Nucleus is visualised by DAPI staining.*



## Basic Research

and characterized. Measurement and theoretical estimation of induced activity in In-nat by high-energy neutrons by theoretical methods and measured. Direction distribution of ambient neutron dose equivalent from 20 MeV protons incident on thick Be and Cu targets was determined. Quantum chemical methods was applied to gain insights into RNA structures to identify the role of the cis Hoogsteen: Sugar-Edge Family of Base Pairs in platforms and triplets. Structure and dynamics of double helical DNA in torsion angle hyperspace was studied. Alterations of thermodynamic properties of DNA base pairs in protein-DNA recognition were observed.

### CANCER

During the year of report, there was consolidation of several activities initiated in the recent years at the Advanced Centre for Treatment, Research and Education in Cancer (ACTREC), and a few new programmes and facilities were initiated.

During the year, there were three major installations for initiating Nuclear Imaging, Magnetic Resonance Imaging and Spectroscopy research in animals and humans (small animal PET-CT-SPECT, Human 3 Tesla MRI and Raman Spectroscopy).

The multidisciplinary clinical research programme was strengthened. There was a doubling of major cancer surgeries performed at ACTREC

from 732 in 2008 to 1492 in 2009. The BMT (Bone Marrow Transplant), Neurosurgery and Tomotherapy research programmes were all successfully consolidated in their second year.

During the year of report, there were 55 indexed publications by ACTREC staff of which 35 publications were in the field of basic and translational research and 20 publications in clinical and medical technology areas.

#### *Clinical Research Centre (CRC)*

During 2009, several protocols/clinical research programmes were initiated or consolidated at the Clinical Research Centre. During the year a total of 2236 cancer patients underwent diagnostic or therapeutic procedures.

The Bone marrow Transplant (BMT) Programme was further consolidated with 36 BMTs (15 allografts) performed during 2009. With 80 BMTs performed in the first two years and very low transplant related mortality (6% for allogeneic & 2% for autologous transplants), comparable to the best centers across the world, the BMT Programme at ACTREC has received national and international recognition.

To cater to the needs of those who do not have a HLA matched sibling, an ambitious programme of Matched Unrelated Donor transplant was successfully initiated in 2009, using HLA matched stem cell from the National Marrow Donor Registry

in USA. A new review and funding mechanism was initiated in 2009 for offering free or greatly subsidized BMT as a life saving measure for deserving poor patients.

The Cancer Surgery Programme at ACTREC saw a doubling of major cancer surgeries performed from 732 in 2008 to 1492 in 2009. The Neurosurgery Programme at ACTREC was further strengthened in its second year with 60 patients undergoing surgery for various types of brain tumour.

The Radiation Oncology programme focused on consolidating its experience and scientific evaluation of the Tomotherapy Hi-ART system and Bhabhatron-II. A total of 883 patients received radiation therapy in 2009 as part of different protocols of which 402 were treated on Bhabhatron-II, 354 on LINAC and 127 patients on Tomotherapy. A total of 256 brachytherapy procedures were performed in the Integrated Brachytherapy Unit. The Bhabhatron-II indigenous telecobalt worked satisfactorily.

The Cancer Genetics Clinic at ACTREC and TMH enrolled 320 individuals from 260 families with suspected inherited predisposition to cancer. These families are now being provided with specialized genetic counseling including pre-test and post-test counseling along with the genetic test report from the ACTREC Cancer Genetics Lab.

## Basic Research

### *Cancer Research Institute*

The year 2009 has seen major strides towards understanding the structural aspects of molecules regulating apoptosis, protein degradation and DNA repair. Inquiries into the molecular interactions and post translational modifications of proteins mediating various cellular processes have evolved from functional analysis in cellular systems into their *in vivo* role in animal models. Molecular profiling of human cancers has identified biomarkers which are being validated and evaluated for their use in cancer management. A molecular imaging program was initiated to strengthen these investigations.

Intricate dissection of the structure and cellular dynamics of a unique trimeric serine protease HtrA2/Omi and high-risk papillomavirus (HPV-18) regulatory E2 protein is targeted towards identifying their novel partners. Crystals of BRCA1/2 and its binding partners like RAP-80, ZBRK1, BARD1 and BAP1 were made and analysis by X-ray crystallography is ongoing. An *in vitro* model system was developed to study the structural, mechanistic and cell biological aspects of protein degradation by the proteasome. Raman scattering and fluorescence spectroscopy are being actively pursued as potential alternatives/adjunct to existing screening methods. In parallel various fibre probe designs for *in vivo* applications are being developed.

Regulation of Cyclin D1 by the transcription factors Sp1, CRE, Ap1, E2F and c-Ets was delineated and the novel expression of histones H2A.1 and H2 was identified in a rodent hepatocarcinogenesis model. A novel sperm mediated gene transfer technology using lentiviruses was developed for generating mice that have a knockdown for 14-3-3 and 14-3-3 for the *in vivo* analysis of their functions in cell cycle regulation. The role of Poly-N-acetyl-lactosamine substitutions on 1,6 branched N-oligosaccharides & galectin-3 in metastasis is being studied in galectin-3 knockout mice.

*In vivo* mechanisms of action of chemopreventive agents, curcumin and poly phenols from tea and grapes are emerging. Nanoparticles loaded with curcumin were developed and are being evaluated for their activity on cells. Methods were standardised to measure the levels of curcumin in plasma. A DBT Clinical Pharmacology laboratory was established at ACTREC for PK/PD studies and analysis of curcumin and metabolites under the DBT programme for “Curcumin clinical trials in cancer”.

Investigations in Oral cancer moved forward in several directions. CGH analysis has shown chromosomal regions 5p13, 8q24, 9p23 and 11q13 and the loss of chromosomal regions 3p14, 8p23 and 18q24. Array CGH is revealing the genes

located in these chromosomal regions. Some of the genes regulating radiation response in oral cancer were identified by microarray analysis as RMB8A, MyoD, KRT13, Tor2A, cdc73. The sequential changes in expression of keratins and other associated proteins during oral carcinogenesis were identified by proteomic analysis in the animal model established last year. Early results indicate that tumour associated antigens which elicit an auto-antibody response in patients with cancer of the gingivo buccal complex have prognostic potential. Proteomic analysis of tumour supernatants has led to the identification of 2,5-Oligoadenylate synthetase 2 (OAS2) as a potential molecule regulating the degradation of the cell signaling molecule CD3 in T cells in oral cancer. A recombinant adenovirus (Ad-HSVtk) was constructed carrying HSVtk for suicide gene therapy of cancer. The recombinant vector was characterised, and its efficacy to kill tumour cells along with cisplatin evaluated. Efforts to make clinical grade Ad-HSVtk are ongoing.

A major program to understand the molecular mechanisms underlying the immune dysfunction in patients with cancer focuses on the role of T cells. Studies are in progress to identify the active fraction from marine Mollusc and Porifera extracts involved in inhibition of osteoclastogenesis. The immunomodulatory properties of

## Basic Research

Panchkarma, herbal and tea extracts were under evaluation.

Global expression profiling in cervical cancers using the Agilent 4K arrays has shown that the genes ITM2B and RNF141 are upregulated and PH4, C19orf46, MAN2A2 and KHK are down regulated in good prognosis and bad prognosis groups respectively. Chromosomal integration sites of High Risk-HPV genomes and the genes located in these regions were under investigation. Studies are in progress to understand role of specific genes and miRNAs whose expression is deregulated in medulloblastomas. Proteomic analysis of the CSF from patients with medulloblastoma has identified three proteins that may have potential to distinguish between the average risk, high risk and metastatic group. A neural stem cell model is being established to understand the role of ubiquitin proteasome pathway in neural stem cell differentiation and tumorigenesis of medulloblastoma.

Major efforts were on to improve the features and efficacy of the indigenous Indian HIV-2 isolate derived lentivirus vector (LV) in gene delivery including shRNA and improving yield and purity of the human papilloma virus type-16 (HPV-16 L1) derived virus like particles. A single step novel molecular assay system to evaluate potential drugs/small molecules which can inhibit HIV replication was under development.

The Cancer Genetics Lab has provided Genetic Testing support to the Cancer Genetics Clinic which enrolled 260 families with suspected inherited predisposition to cancer during 2009. A DNA bank and EBV cell line repository was created and germline mutation analysis performed for BRCA1, BRCA2, TP53 and Chk2 genes for hereditary breast and ovarian cancer families, RET proto oncogene for MEN syndrome and medullary carcinoma of the thyroid, and TP53 gene for Li-Fraumeni syndrome cases. Some novel missense mutation in BRCA1 and BRCA2 genes was identified which are being characterized by structural and functional studies.

The Comparative Oncology Programme focussed on diagnosis

and management of cancers in pet animals and attended to eighty four referral cases. The small animal high resolution microPET-SPECT-CT was commissioned. A programme to develop molecular imaging technologies towards real time visualization of normal as well as abnormal cellular processes at the molecular or genetic level, was initiated.

### SYNCHROTRONS & THEIR UTILISATION

#### Indus Synchrotrons

##### *Indus-2 and beamlines*

Round the clock operation was started following completion of training and licensing of 30 staff members. Indus-2 was operated to



*Indus-2 Synchrotron Radiation beam line with shielding hutch*



## Basic Research

provide synchrotron radiation (SR) for experiments as per user requirement at energies of 2.0, 2.4 and 2.5 GeV.

The EDXRD and EXAFS beamlines are operational and made available to users. Scientists from High-Pressure Physics Division, BARC have recorded diffraction pattern of  $Dy_2O_3$  at different pressures and obtained Equation of States for Uranium. EXAFS beamline was used for study of  $PbMoO_4$ ,  $Pb_5Ge_3O_{11}$  and Uranium sorption in  $Al_2O_3$  and for investigation of  $La_2MnCoO_6$ . The front end for x-ray micro-fluorescence beamline and components up to the double crystal monochromator were installed. The mirror system box for lithography beamline was commissioned. Gate valves GV0 were installed at SR beam ports located on different bending magnets of the ring to facilitate installation of beam line front ends.

Radiation shielding hatches for Angle Dispersive X-ray Diffraction (ADXRD) and Energy Dispersive X-ray Diffraction (EDXRD) beam lines were installed and commissioned in Indus-2 experimental hall.

Indus-2 ring survey and beam line alignment

Measurements were made for installation and calibration related to the mirror system on the lithography beamline of Indus-2 and the infrared beamline on Indus-1. The coordinates of the reference points of the new beam

profile monitors were determined with respect to the beam axis for their installation in the machine.

### *Indus-1 and beamlines*

Indus-1 storage ring operated smoothly in user mode providing an average beam time of ~200 hours/month. The beam lifetime which was 75 min at 100mA in the beginning of the year increased to ~85 min towards the end of the year. During this period the average pressure of the ring decreased from  $6.710^{-9}$  mbar to  $2.410^{-9}$  mbar.

### *Indus-1 beamlines and utilization*

The diagnostics beam line was commissioned by tapping synchrotron radiation from one of the existing beam lines in Indus-1. The setup is fully automatic and displays beam position information online along with the

beam current.

Several groups from DAE institutes, IITs, Universities and other National Labs used the beamlines installed on Indus-1, viz 1) ARPES (Angle Resolved Photo-Electron Spectroscopy) 2) HRVUV (High Resolution Vacuum Ultra-Violet) 3) Photo-physics 4) Reflectivity, and 5) AIPES (Angle Integrated Photo-Electron Spectroscopy) beamlines in Indus-1. The first result from the Angle Resolved Photo Emission Spectroscopy (ARPES) beamline in Indus-1 was recorded on a single crystal of  $CeAg_2Ge_2$ . The normal emission spectra at different photon energies showed clear dispersion of the band structure. The reflectivity beamline was used by researchers from IIT Madras, IIT Delhi and RRCAT scientists. Important results were obtained on the photo-triple-ionization of  $CO_2$



*Improvements in Indus accelerators*

## Basic Research



*A 2 kW RF amplifier experimental set-up*

molecule, fabrication of multilayer for soft x-ray polarizer and porosity study at buried interfaces.

A number of power supplies in Indus Accelerator Complex (IAC) were upgraded to improve their performance with regard to response time, thermal management, current tracking and ease of maintenance. Improved versions of sextupole power supplies were installed and commissioned. These power supplies feed separately the Indus-2 focusing and de-focusing sextupole magnets. The new module of booster dipole power supply will enhance the ramping rate, which in turn will increase the injection rate into Indus-1 and Indus-2 by one and a half times. With the new Indus-2 dipole magnet power supply, capacitor over current tripping has become a

rare event. The active filter put in this power supply has improved the dynamic response of the power supply by way of fast correction for changes in AC input to the unit. TL1 and TL2 quadrupole magnet power supplies were undergoing upgradation.

A 2 kW, 505.8 MHz amplifier operating in continuous mode was designed, fabricated and tested. This amplifier employs eight numbers of 300W amplifier modules, two numbers of eight-way power combiner/divider, high power coaxial type directional couplers, driver amplifier stages and control electronics. All these RF components were developed indigenously. The amplifier module is based on two 150W RF Power MOSFETs. The experimental observations were found to be in good agreement with theoretical calculations for individual components and assembled 2kW amplifier.

The Indus Booster Synchrotron RF System employs conventional high power RF amplifier based on tetrode tube BEL 4000 CX. This tube was indigenously manufactured by M/s BEL for TV transmitters. Presently, this tetrode tube is no more in production range and hence not available. The booster RF cavity needs about 800 W of RF power to develop 22 kV gap voltage. Hence the development of 1 kW power amplifier based on solid state

technology was taken up. This will also improve the reliability, maintainability and availability of the system. In addition to the enhanced life and ease of maintenance the present robust MOSFET technology allows development of high power solid state amplifier free from the thermal runaway and secondary breakdown problem.

### Accelerator controls

#### *Indus-2 control system diagnostics:*

The distributed control system of Indus-2 consists of intelligent controllers and software modules at the three layers of control system. About 100 controllers are deployed to handle over 8000 parameters. In such a situation, keeping track of the various system aspects, e.g. system healthiness, authenticity of the information, knowledge of faults, recovery from faults etc. are all very important for smooth working of the control system and finally, the machine. To achieve this, the system was incorporated with many diagnostic features thereby reducing the down time of the machine by lowering the time to diagnose the problem and repair it. This resulted in increased availability of the machine for experiments.

Indus-2 uses ultra high vacuum of the order of  $10^{-10}$  m bar for keeping high energy and high current electron beam circulating for hours, while the resultant

# Basic Research

synchrotron radiations in the peripheral beam lines are used for experiments. To isolate the ultra high vacuum of the ring from the beam lines, manually operated gate valves were replaced by pneumatically operated ones. The pneumatic gate valves allow remote controlled operation and hence ease of regulation. These valves are kept closed until the electron beam injection in the machine is to be started. During machine shutdowns, say during maintenance, these valves are necessarily kept closed to safeguard ring vacuum. The status of all the valves is constantly monitored and logged.

### ***Microtron control system upgradation using Experimental Physics and Industrial Control software:***

Essential developments towards upgradation of the microtron control system using EPICS are over. The simulation testing of the new system was also completed. First round of field

testing was carried out successfully and the system would be integrated shortly.

### **CYCLOTRON & THEIR UTILISATION**

#### **Superconducting Cyclotron Utilization**

The Superconducting Cyclotron Utilisation Project (SUCCUP) of VECC aims at developing users' facilities for the utilization of superconducting cyclotron for basic and applied research in nuclear physics, condensed matter, biology, etc. During the report period, the general purpose Scattering Chamber was installed and commissioned.

Large modular BaF<sub>2</sub> gamma detector array was completed and readied for experiment. Testing of forward array telescopes and readout system was completed and forward array detectors and electronics procurement progressed. Fabrication of

Neutron Multiplicity Detector was completed, and fabrication of Plastic phoswich extreme forward array detectors continued. Installation of various instruments was in progress.

The goals of the VECC's project "Modernization of VECC Technical Systems" is to modernise some of the subsystems of cyclotron. During the report period, a shut down of the cyclotron was undertaken to implement these changes.

#### ***Advanced Radioactive Ion Beam Facility***

A low energy Radioactive Ion Beam (RIB) facility, which will deliver 1.3 MeV/A beams is also under development at VECC.

#### **Fusion & Other Plasma Technologies**

##### ***Aditya Tokamak***

At the Institute of Plasma Research, the main transformer of Aditya operation was made operational. Experiments for



*Segmented Reaction Chamber at Super Conducting cyclotron experimental hall at VECC*



*Radioactive Ion Beam facility at VECC*



## Basic Research

upgrading operation window of the Aditya tokamak was continued with the new error field compensating coils, preionization using a magnetron source and with upgraded operational diagnostics. Data Acquisition and Control for Plasma position was upgraded. The diagnostics for physics studies were undergoing upgrading. New diagnostics like Infrared Imaging Video Bolometer, Focal plane array based Infrared camera were also in the process of development. Alignment and Calibration for the Aditya-Thomson scattering system was over and it was ready for regular operation. The imaging diagnostics for Aditya was operational. The data acquired from the earlier shots were undergoing analysis with the collaboration with IIT Kanpur. Fast wave heating and ion Bernstein wave heating experiments were in the planning stage in ion cyclotron frequency range and RF heating system was under development and in the process of installation on Aditya. RF power was introduced when the plasma was present in the Tokamak. RF power was radiated by the antenna. Different diagnostics detected the signals produced due to plasma heating.

### ***Steady State Tokamak-1***

The Steady State Tokamak-1 (SST-1) refurbishment activities under 'SST-1 Mission' gained further momentum at validating the engineering and technology issues in a focused manner

towards the early realization of the SST-1 first plasma. Using the spare superconducting toroidal field (TF) coil excellent repeatable sub nano-Ohm leak tight DC joint resistances were experimentally obtained. With these demonstrations, the processes and technologies of fabricating the low DC joints in the SST-1 TF and PF magnets winding packs were completely established. They are ready to be adopted onto the SST-1 magnets with appropriate quality assurance and control. Hot Nitrogen Baking facility of the SST was commissioned successfully with the SST-1 vessel sector as a load, with suitable feedback and controls on a programmable logic control platform. The first SST vacuum vessel module containing the baking channels was baked up to  $\sim 150^{\circ}\text{C}$  for extended hours with this facility in a dedicated baking chamber and thereby demonstrating the soundness of the baking channel repairs. The SST 80 K panels have finally been decided to be of double embossed type containing bubbles and would be cooled with single phase nitrogen at an inlet pressure as high as 6 bar.

While the machine refurbishment was going in full swing, the diagnostics were also getting readied for the operation. The diagnostics such as Thomson Scattering diagnostic system, Imaging diagnostics, Far Infrared Interferometer, Helium Beam Diagnostics, Infrared Thermography, Spectroscopy etc. were all

in the final stages of procurement and testing. In the plasma heating front, Gyrotron testing was getting readied with new ignitron based crowbar system, which was tested successfully. A new solid-state modulator power supply was also procured.

In the fundamental plasma physics, after the relevant preliminary experiments, the fabrication and the testing of the final stage for the new set ups were being worked out. The experiments on BETA (Basic Experiments in Toroidal Assembly), LVPD (Large Volume Plasma device), Non-neutral plasma system (SMARTX) have also been giving valuable physics insights in the basic plasma physics.

Under the technology developmental programmes in the 11th Five Year Plan, divertor technology, fusion relevant magnet, negative ion source and technology, test blanket module (TBM) for ITER and fusion plasma diagnostics are the major topics under which a focused research and development is being pursued at IPR with the collaboration with various relevant institutions in the country. For divertor technology, development of new material and fabrication technology, and thermal load testing continued. In some collaborations, MoUs were also signed.

Development of indigenous fusion relevant high current carrying multiply stabilized multi-filamentary technical  $\text{Nb}_3\text{Sn}$

# Basic Research

superconducting strand was one of the primary objectives of the Fusion Relevant Magnets development. Earlier indigenous NbTi based cable-in-conduit-conductors (CICC) up to 30 kA in 5 T and 4.5 K was designed and developed over long lengths in a joint initiative with BARC. A 'Special Purpose Winding Machine' (SPWM) suitable for winding the fusion relevant superconducting magnets is currently being designed in a joint initiative with Indian Industry. For the development of negative ion source and technology, the plasma source for the BATMAN type source was accepted after the relevant tests for mechanical, electrical and vacuum specifications. It is presently available for experiments. The accelerator assembly was under fabrication at PVA Tepla, Germany. The TBM programme is focusing on the development of Lead-Lithium cooled Ceramic Breeder (LLCB) (half-port size) which has the characteristics of both Solid Breeder and Liquid breeder blanket concepts. BARC and IGCAR were involved in the design and development of the TBMs and the associated technologies such as fusion neutronics, fusion engineering design, safety, liquid metal technologies, thermofluid MHD, lithium ceramics, beryllium pebbles, structural materials, fabrication technologies for the TBM programme. In this regard, MoUs were signed between IPR-BARC and IPR-IGCAR for

development of nuclear technologies required for TBM delivery to ITER. For the 14 MeV neutron irradiation experiments, most of the subsystems required for the indigenous D-T neutron generator were procured and whole system will be commissioned in the coming year.

In the theoretical and computational plasma front, numerical simulations like generalized electron magnetohydrodynamic (G-EMHD), gyrokinetic simulations and the studies under the collaboration with TIFR progressed. A numerical simulation code for simulating a strongly coupled plasma system in one dimension using generalized hydrodynamic (GHD) fluid model was tested. Studies on strongly coupled Yukawa systems under a weak external drive using non-

equilibrium molecular dynamics simulations (MPMD) were also conducted.

## MATERIAL SCIENCES

A molecular dynamics code LAMMPS was used to analyze a series of MD runs on the interaction of an edge dislocation with a nano void generated through irradiation in Ferritic-Martensitic steel having 9% chromium and different percentage of helium. The additional shear stress required to overcome the resistance for various sizes of voids are calculated. This is an input to the dislocation-dynamic calculations for calculating the change in flow stress due to irradiation.

60m long 30kA hybrid cable in conduit conductor (CICC) was developed and fabricated. Development and fabrication of

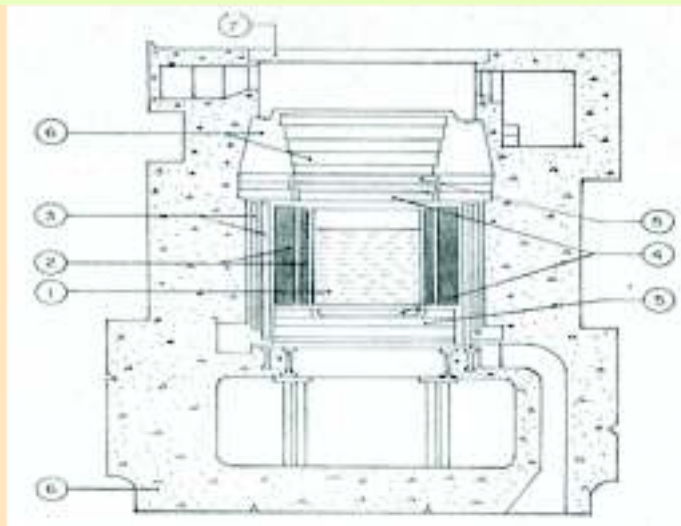

1. Aluminium reactor vessel    2. Graphite reflector  
3. Cast iron side thermal shield    4. Aluminium thermal shield  
5. Steel thermal shield    6. Biological shield

## Basic Research

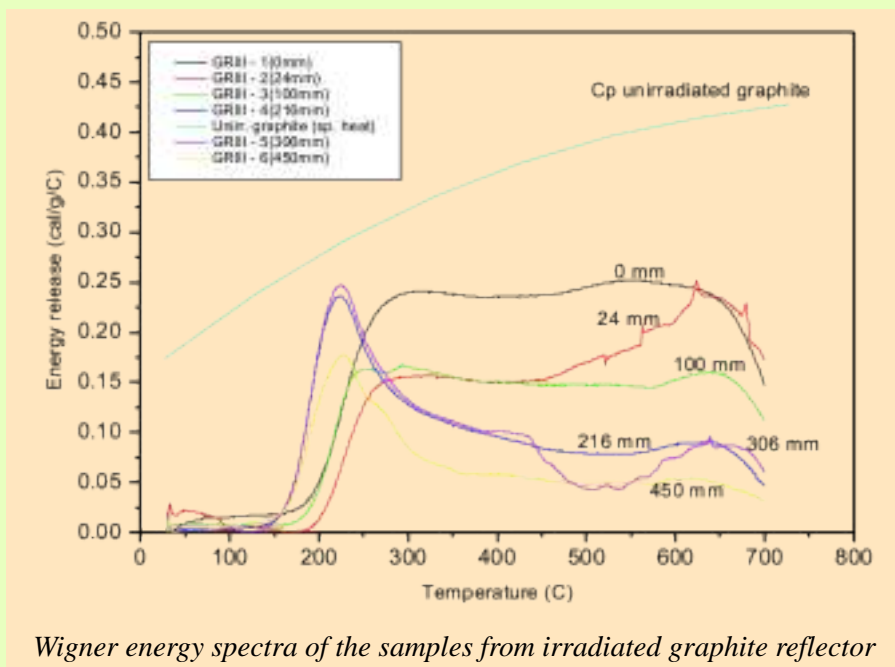

The purity of these nanotubes was optimized by Taguchi method with temperature of synthesis (600, 700 and 800°C), type of catalyst (Nickel formate, cobalt formate ferrocene), concentration of catalyst (5, 10 and 15 wt %) and type of catalyst-support.

Multiwalled Carbon Nanotubes synthesized by chemical vapour infiltration method were treated with concentrated nitric acid and heated for 24 hours in order to create active centres on the surfaces and to open end caps.

Technology for preparation of Ni-Ti alloys and heat shrinkable ferrules for Light Combat Aircraft is transferred to F&F Division of HAL, Bangalore, under a tripartite MoU. The construction of a new shop floor dedicated to this project was completed. A 200 kg vacuum arc re-melter (VAR) and a 30 kg vacuum induction (VIM) furnace were installed and commissioned.

Complete phase and microstructural analyses of the off-stoichiometric  $Ni_{55}Fe_{19}Ga_{26}$  magnetic shape memory alloy (MSMA) were performed using a combination of diffraction and microscopy techniques. X-ray

$Nb_3Sn$  based low temperature multifilamentary superconducting wire was initiated.

Measurement of release of Wigner energy of graphite plug from I-15 instrument hole of east thermal column of CIRUS was carried out to ascertain the extent of damage. A schematic diagram of reactor indicating the location of the graphite and the sampling plan are shown. Wigner energy release spectra for all the samples

of graphite were measured using a differential scanning calorimeter. As all energy release spectra are below the specific heat curve at all temperatures for graphite there will not be any uncontrolled release of energy indicating that the graphite is good enough for continued use in the reactor.

Carbon nanotubes (CNTs) were synthesized from acetylene (flow rate 100 cc/min) diluted with nitrogen (flow rate 1000 cc/min) for 30 minutes.

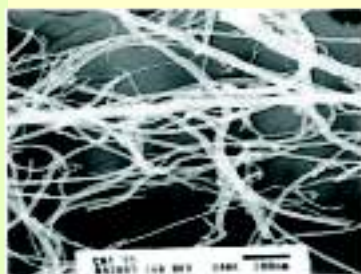

*TEM image*

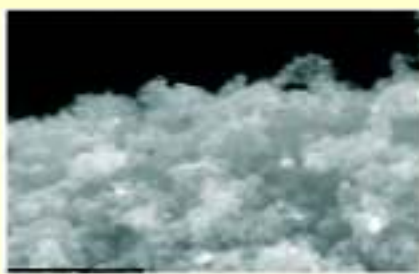

*SEM image*

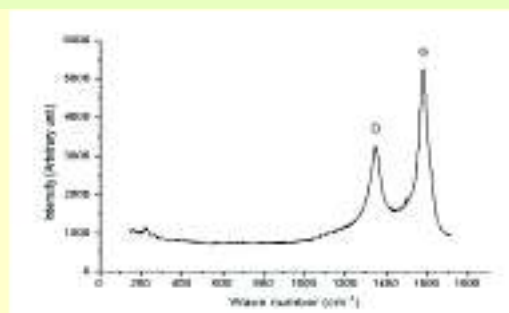

*Raman spectrum*



# Basic Research

diffraction analyses revealed that the majority phase was a non-modulated (NM) tetragonal martensite.

At RRCAT, various off-stoichiometric Heusler alloys belonging to the  $\text{Ni}_{50}\text{Mn}_{1-x}\text{In}_x$  family were studied through magnetization, magneto-transport and heat capacity measurements done as a function of temperature (2-400 K) and magnetic field (0-9 kOe). The main focus was on the alloy compositions with x (indium concentration) ranging from 15 to 16. These alloys exhibit a first order austenite to martensite phase transition with the lowering of temperature, which is coupled to a magnetic transition as well. The alloys with x = 15.5 and 16 compositions exhibit a very large magnetoresistance close to 250 K across this magneto-structural transition. Heat capacity experiments show a large entropy change across this transition in

these materials, which leads to a large magnetocaloric effect. The alloy composition with x = 16 is found to exhibit a large magneto-thermal conductivity and magneto-thermoelectric power across the same phase transition. Study of magnetocaloric effect reveals that the partial substitution of manganese (Mn) by chromium (Cr) in the x = 16 composition enhances the refrigerant capacity of the material by 15 % and pushes the working temperature range by about 30K towards the room temperature. A large (~0.11 %) temperature and magnetic field induced strain was also observed in the x = 16 alloy which shows the potential of this material as a ferromagnetic shape memory alloy.

The intermetallic compounds  $\text{DyPt}_2$  and  $\text{GdCu}_6$  undergo magnetic phase transitions below 20K. The temperature and magnetic field dependence of heat

capacity of these materials were studied to find out the effect of these variables on the entropy of these materials. While both the materials turned out to be potential passive magnetic regenerators below 30K,  $\text{DyPt}_2$  was also found to be a potential magnetic refrigerant below 50K. These studies are relevant for environmentally friendly future magnetic refrigeration cycles suitable for hydrogen and helium liquefaction.

Preliminary magnetization studies on bulk niobium samples show that the flux pinning properties of the material depend on its grain size. Studies on thin Nb films prepared earlier by Ion Beam sputtering technique revealed interesting dependence of the superconducting properties of the on the thickness of the films. The activities on Nb bulk and thin films are related to their applicability in superconducting

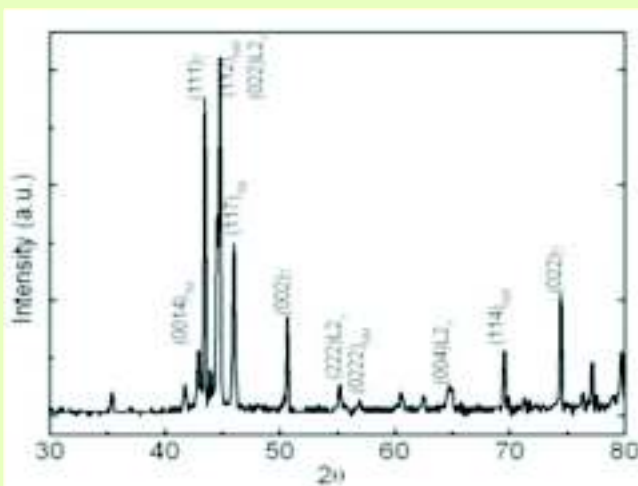

*X-ray diffraction pattern of  $\text{Ni}_{55}\text{Fe}_{19}\text{Ga}_{26}$  alloy showing NM martensite and  $\gamma$ -phase and traces of 14M and L2<sub>1</sub>-phase*

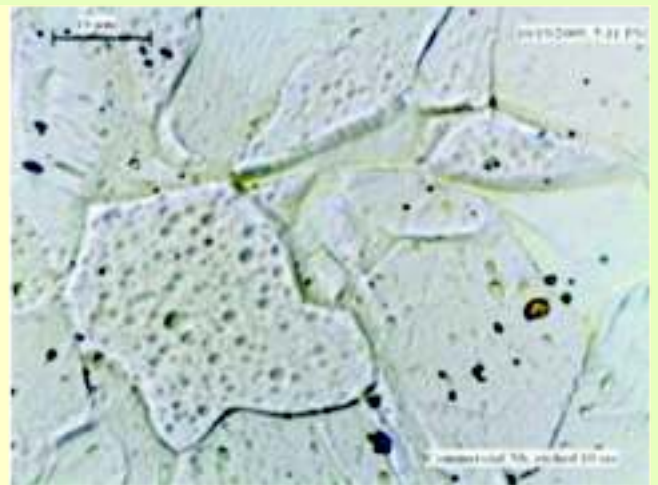

*Optical micrograph of pure Nb with grains of nearly 20  $\mu\text{m}$  size*

# Basic Research



*NaCl, LiNbO<sub>3</sub>, Bi<sub>12</sub>SiO<sub>20</sub> crystals grown using developed ADC puller*

RF cavities.

The indigenously developed nitride MOVPE system was made operational and epitaxial GaN layers were deposited on Sapphire substrates. It incorporates an indigenously designed gas injection system through a showerhead in a vertical reactor which is designed for operation at 1100°C.

An indigenous automatic diameter control system was designed and developed in-house. This automatic diameter control

pull head was successfully interfaced with a resistive heating furnace to grow crystals with melting point upto 1300°C. Sodium Chloride (NaCl), Lithium Niobate (LiNbO<sub>3</sub>) and Bismuth Silicate (Bi<sub>12</sub>SiO<sub>20</sub>; BSO) single crystals were successfully grown in the developed system in automatic diameter control mode.

Carbon aerogel electrodes of 20 cm x 20 cm size were developed using the carbon aerogel powder, and suitable

binder by wet phase exchange process. This powder has specific surface area of 512 m<sup>2</sup>/gm and specific capacitance is 60-65 F/g. A desalination cell consisting of two electrodes was made and desalination capacity of ~72µmoles/g was achieved for initial salt concentration of 500 mg/litre.

## Helium Recovery

During the report period, VECC completed the project of production of Helium from Soil Airs in Geothermal Areas, and Recovery and Analysis of Helium from Hot Spring.

## Non-cryogenic helium purification and seismic related gas assaying

During the report period, a two column pressure swing adsorption (PSA) system was designed and successfully tested in the laboratory. Equilibrium Isotherms and breakthrough measurements were done with carbon molecular sieves (CMS) and Li impregnated zeolites (LiLSX). A vacuum cryostat and sample holder for GM cryo-head were fabricated.

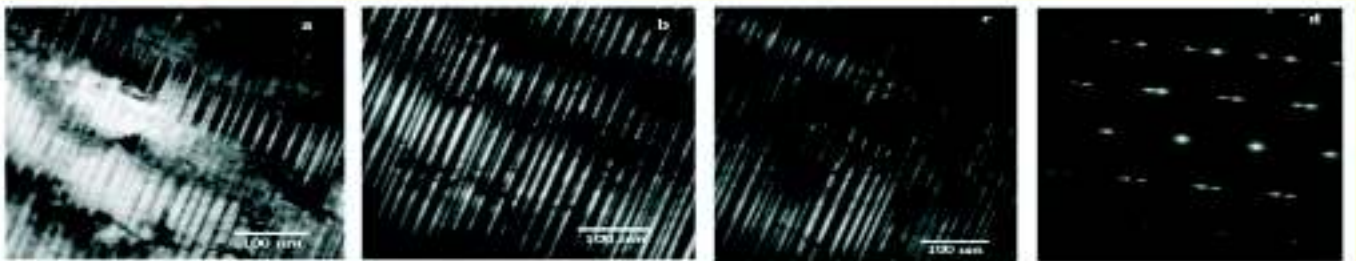

*Internally-twinned tetragonal NM martensite. (a) BF micrograph, (b) and (c) DF micrographs and (d) corresponding twin diffraction pattern of [01-2]NM zone*

## Basic Research



(a) Bulk metallic glasses (b) Composites of bulk metallic glass and tungsten fibres  
(c) Cross sectional view of the composite

Commissioning and operation of the adsorption based three column helium purification system will be taken up shortly.

The research work of TIFR explored the unique properties of graphene in two experiments.

Investigations were carried out on the evolution of superconductivity with disorder in epitaxial NbN thin films, that showed that in 3-dimensional disordered NbN films superconductivity get destroyed exactly at the metal-insulator transition.

Taking the Cu-Nb metallic glass as a model system, direct experimental evidence of nanoscale compositional clustering (2-3nm sized Cu-rich and Nb-rich clusters) with localized short-range chemical ordering, was found.

Nanorod and nanotube arrays of TiO<sub>2</sub>-based tri-titanate structures were fabricated using a hydrothermal technique, and the mechanism of formation was studied by high resolution electron microscopy.

It was recently shown that the

breakdown voltage (VB) of air at STP can be reduced by over 90%, by using a metal nanorod array electrode instead of plane parallel electrodes. Electrical discharge in such nanorod-based devices can be sustained for long periods at an applied voltage as low as 10V, a fact that could be of great significance in designing low power discharge devices of many types.

An atomic layer deposition system was installed that allows deposition of high-k dielectric for field effect transistors.

Transmission electron microscopy established that this phase was the internally-twinned tetragonal non-modulated (NM) type martensite.

Bulk metallic glasses of three

different compositions (Zr-Cu-Ag-Al, Zr-Ti-Al-Cu-Ni and Zr-Cu-Fe-Al) were prepared and using melt infiltration technique, composites of alloy with tungsten as reinforcing material were produced. The cut pieces from these samples were characterized by XRD and optical, scanning and transmission electron microscopy. The glass formability of Zr-Cu-Ag-Al was found best among the three compositions. The mechanical tests carried out at room temperature showed that the toughness of composites were higher than the monolithic bulk metallic material.

Modified Finemet alloy of composition Fe<sub>68.5</sub>Cu<sub>1</sub>Nb<sub>3</sub>Si<sub>18.5</sub>B<sub>9</sub> was produced by melting pure elements in an electric arc furnace.

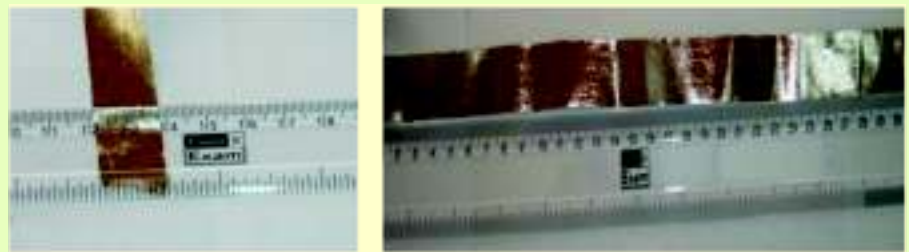

Planar flow cast amorphous ribbon of Fe based soft magnetic alloy



# Basic Research

Nanocrystalline phases were produced by controlled heat treatment of the amorphous precursor.

## INTERDISCIPLINARY AREAS

At TIFR, several repeat experiments were conducted on electron induced damage to plasmid DNA in the energy range 11 to 22 eV. Single strand breaks were observed in this energy range, while very little double strand breaks occur.

A complete description of the *Drosophila* midgut epithelial architecture and the enzymatic basis of acid and base secretion by this epithelium in both larval and adult forms were published.

Research carried out identified that the circulating chromatin fragments (CCF) in the human body are novel DNA-damaging agents in cultured cells (collaboration with ACTREC, Navi Mumbai) making them a biological mimetic of high LET radiation.

The Zeiss 710 NLO microscope was installed and commissioned for research especially using multiphoton microscopy.

At the TIFR's National Facility for High Field NMR, a new 700 MHz spectrometer was installed.

Using tethered balloon and the conventional cellular system, its use for rural wireless telephone having an economy index of 30:1, was demonstrated.

## INTERNATIONAL RESEARCH COLLABORATION

Under the Indo-Italian cooperation programme, the energy-response studies of the LiF:Mg,Cu,P, LiF:Mg,Ti and CaSO<sub>4</sub>:Dy TLDs were carried out by BARC with synchrotron radiation in the energy range 10-34 keV using a 2.5 GeV electron accelerator located at Elettra Synchrotron Light Laboratory, Italy. The study utilized experimental, Monte Carlo simulation and analytical methods. All the three approaches were found to be in good agreement with each other in low energy region. This study will be useful for carrying out radiation protection dosimetry around the synchrotron beam lines with the application of proper correction factors.

Under INPRO programme, an

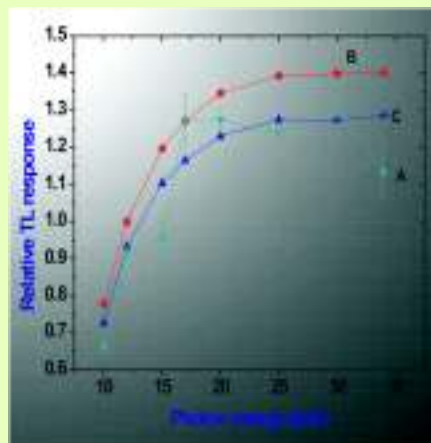

Energy response of LiF:Mg,Ti TLD-100:  
A-Experimental response,  
B-Monte Carlo calculated response,  
C- Analytical response

international benchmark, an exercise was undertaken to evaluate the reliability of Passive Decay Heat Removal system (PDHR) of 2400 MWth French Gas cooled Fast Reactor (GFR). BARC has been using its Assessment of Passive System Reliability (APsRA) methodology for evaluating the reliability of the PDHR.

Under the Indo-German DST-DAAD Personnel Exchange Programme, a collaborative research was performed between BARC and IKE, University of Stuttgart, Germany in the area of coolability behaviour of particulate debris beds and several experiments were performed at IKE, University of Stuttgart, for evaluation of dryout heat flux of the heat generating particulate debris beds.

An international benchmark exercise was undertaken to evaluate the capability of models for prediction of severe accident

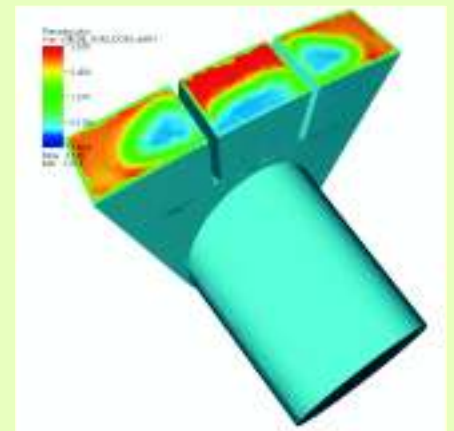

Velocity distribution in a moderator inlet diffuser of 540MWe PHWR

## Basic Research

behaviour of CANDU-6 PHWR under an IAEA CRP programme.

An implementing agreement on validation of Computational Fluids Dynamics Softwares was signed with CEA, France. Various problems related to nuclear components were jointly solved using the CFD code TRIO\_U supplied by CEA. An analysis was carried out to predict the flow distribution in a moderator inlet diffuser of Indian pressurised heavy water reactor using Trio-U. Some of the results are shown in the following figures.

### ***Development of prototype solid state bouncer modulator for LINAC 4 project at CERN***

CERN is building a 352.21 MHz 3 MeV RFQ based test stand as first part of LINAC 4. An all solid state bouncer compensated modulator was developed at RRCAT. The modulator has achieved rated specifications and was accepted by CERN team after rigorous testing at RRCAT. This included a number of new developments e.g. optical trigger circuits, high voltage solid state switch, high voltage automatic safety relay, energy storage capacitors, bouncer circuits, arc protection circuits and damping networks.

### ***Development of 1MW peak power capacity test stand at 352.2 MHz using CERN LEP klystron 2089 and RRCAT bouncer modulator***

At RRCAT several research and development activities are



*1MW pulsed test stand developed at RRCAT*

being pursued towards realization of high power pulsed technologies for the pulsed H- accelerators. To qualify the development subsystems, electronics and components, a pulsed 1.3 MW 352.2 MHz test stand was built around a 1.3MW, 352.2 MHz klystron obtained from CERN.

### ***Development of 1.3 GHz superconducting (SC) RF cavity***

Two prototype 1.3GHz single cell SC niobium cavities were fabricated jointly with IUAC, New Delhi. The testing and qualification of these two cavities was also done successfully at RRCAT for mechanical dimensions, RF measurement and leak testing both at 300K & 77K. These cavities were shipped to Fermi National Accelerator Laboratory (FNAL) USA for processing and cold testing for their performance evaluation at 2K as a part of the joint

collaborative activity.

The Institute of Physics continued its research collaboration programme in experimental high energy nuclear physics at Brookhaven Laboratory, USA as well as at CERN, Geneva, Switzerland. It also carried out research collaborations under Indo-France, Indo-German and Indo-Russian Collaboration Programmes.



*Two single cell cavities*

# Basic Research

## INTERNATIONAL THERMO-NUCLEAR EXPERIMENTAL REACTOR

### ITER-India

During the report period, two Procurement Arrangements were signed and pre-procurement activities for the remaining ITER packages continued.

For various design, development and analysis work, MoUs with Electronics Corporation of India Ltd., Nuclear Power Corporation of India Ltd. and Engineers India Ltd. were signed.

Procurement Arrangements for In-Wall Shields and Diagnostics Neutral Beam power supply were signed. Also, a task agreement was signed for ITER Disruption and VDE modeling and electromagnetic load estimations.

For the remaining procurement packages, interaction with potential equipment suppliers, and detailed design, and analysis for various equipment and systems, continued.

Activities related to neutron transport had started and neutron transport analysis of upper port plug X-ray diagnostics was partially completed.

Structural distortions for different welding types were modeled and quantified, and vibration & thermo-hydraulic analysis was completed for upper port plug. A conceptual layout of diagnostic components related to the x-ray crystal (survey) spectrometric instrumentation in an Equatorial Port plug on ITER

was also completed.

Estimates of the beam emission spectroscopic signal strengths from various view chords along the diagnostic neutral beam were computed to arrive at a conceptual design of the BES equipments.

During the report period, the developments of a MATLAB version of the ECESIM code to calculate the ECE radiation from tokamak plasmas, and computational tools to calculate the insertion loss of wave propagation through corrugated waveguides, were noteworthy. Various hydraulic network analyses were also done.

Updating the process flow diagrams of the component cooling water system, chilled water system and heat rejection system; Completion of the Conceptual Design Review of certain systems; Development of process flow diagram of cryo-distribution system as per ITER cryogenic system operating modes and executing process analysis; Studies on seismic interface at the ITER tokamak building with the main cryogenic transfer lines, were the other major activities.

Some other activities were : Completion of engineering design and Final Design Review for DNB; Consolidation of Indian test program for DNB and of Indian participation in the NBTF experiments; Initiation of design of DNBPS system, and finalization of specification for major components.

Procurement activities for

different sub-system/components related to R&D unit had started. Some low power RF components, capacitors, measuring instruments and vacuum tube for pre-driver stage were received.

Design Review of ion cyclotron power supply system and all the technical documentation for the Procurement Arrangement; Design of prototype for IC power supply; Simulation model in PSIM and analysis of various operating conditions, were completed. A scale down model (1:3) of one IWS block with 10 plates was made.

## INTER-INSTITUTIONAL RESEARCH PROGRAMMES

### *Indian Lattice Gauge Theory Initiative (ILGTI):*

The thermodynamics of SU(N) gauge theories at large N was investigated by the TIFR research team, by studying the theory numerically for N=3-6. Part of this computation was performed on the Cray X1 at TIFR.

### *Search for Neutrinoless Double Beta Decay:*

The detailed project report for the positive ion injector for the superconducting LINAC was completed, and the niobium cavity design progressed.





# Chapter : 6

## Research Education Linkages

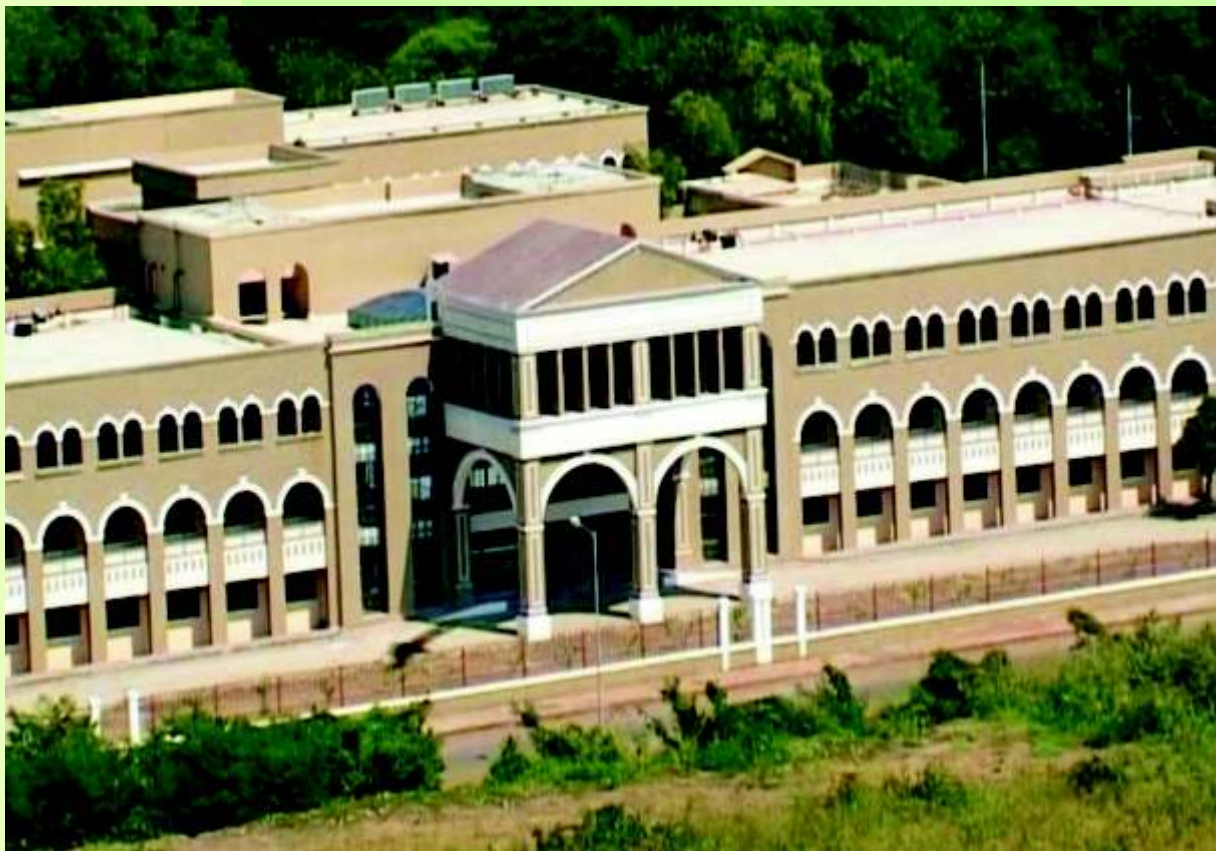

*BARC Training School Building  
(It also houses offices of Homi Bhabha National Institute)*

# Research Education Linkages

## **HUMAN RESOURCE DEVELOPMENT & KNOWLEDGE MANAGEMENT**

The selection of suitable candidates for the Orientation Course for Engineering Graduates & Science Post-Graduates (OCES) and DAE Graduate Fellowship Scheme (DGFS) were carried out through the process of release of advertisements inviting applications, conducting written test for the science disciplines, organizing the personal interviews. 30 candidates were eventually absorbed into the two schemes.

The OCES-2007 and OCDF-2007 courses were conducted and the placement of 127 Trainee Scientific Officers (TSOs) and 15 Fellows was carried out. The practical training (1 to 2 months) and project work (2 to 12 months) of BE/ BTech/ MTech/ Engg Diploma/ MSc/ MCA students from different universities were also facilitated. Over 1100 students from all over India have undergone practical training/project work in various Divisions of BARC during 2008-09.

OCES courses (regular as well as electives) are also offered to the DAE/non-DAE staff. A large number of DAE staff has successfully participated in the 11 elective courses.

The Training School relocated its activities to the New Training School Complex at Anushakti Nagar.

Induction training in

operational radiation protection, for scientific assistants joining the HS&E group continued. The One-year post M.Sc. Diploma in Radiological Physics course affiliated to Homi Bhabha National Institute (Deemed University) continued to meet the mandatory trained manpower requirement of radiation safety professionals in medical, industrial, research and agricultural applications of radiation. Twenty eight students completed the course successfully in the year 2008-2009.

Homi Bhabha National Institute (HBNI) continued to strive for achieving excellence in the academic programmes in DAE. Regular academic programmes at its ten Constituent Institutions were conducted. The programmes currently being conducted included Post Graduate Diploma in Engineering and Science disciplines, M.Tech., M.Phil., M.Sc.(Engg), Ph.D., integrated M.Sc.-Ph.D., Diploma in Radiation Medicine (DRM), Diploma in Medical Radio Isotope Techniques (DMRIT), and Diploma in Radiological Protection (DipRP). An application was submitted to the Ministry of Human Resource Development to include National Institute for Science Education and Research (NISER), Bhubaneswar as eleventh constituent institution of HBNI where integrated B.Sc-M.Sc. courses as well as Ph.D. programme shall be conducted. The lecture courses on various

topics to enable the employees to earn credit points which may be used for the purpose of HBNI degrees/diplomas were started in IGCAR and BARC. The number of candidates enrolled for Ph.D. is 802. The discipline-wise break up is: Engineering Sciences 119, Physical Sciences 411, Chemical Sciences 122, Life Sciences 73, and Mathematics 77. 21 students completed the requirements for the award of Ph.D. degree. These students were issued provisional degree certificates. Total number of results declared for all degrees/diplomas was 108.

Total number of recognized HBNI faculty is 573. The discipline-wise break up is: Engineering Sciences 92, Physical Sciences 272, Chemical Sciences 114, Life Sciences 67, and Mathematics 28.

For selection of engineers and science post graduates for various units of DAE through BARC Training School (OCES/DGFS-2009) for year 2009, an automated process for its entire cycle was designed, developed and deployed by NPCIL in public domain and around 400 engineers and science post graduates for various units of DAE for year 2009-10 were selected.

A "Qualification Program for Construction" was developed and implemented. During the year, one year orientation training of 30 fresh NTPC engineers along with fresh NPCIL engineers were undertaken. The "First Batch" of Civil Engineers, at Post Graduation Level was trained at



## Research Education Linkages

HBNI - BARC Training School, based on the re-developed syllabus with "Project Management".

A Standing Training Committee constituted by NPCIL during 2009, provided impetus to training and skill development at various levels. Training programmes like "Engineering deliverables for NPP", 'Honing the Managerial Skills', 'International Negotiating Skills', 'Human Resource Management for Line Managers' and "Construction Engineers" were implemented as an ongoing programmes. During the year, about 10,000 person-days of training on above modules to SO/D to SO/G level officials were imparted. The proceedings as well as the lectures delivered during various training programs were progressively made available on Knowledge Management Portal on NPCIL intranet 'Prithvi'. On-line availability/browsing of ASME and ASTM codes with quarterly updation, titles of books and journals available for issue and meeting mandatory requirements like stocktaking were ensured as a part of library services. Fuel Handling Training Simulator was commissioned for use by NTC TAPS-3&4 for training, qualification and licensing purpose. Web based Training packages related to nuclear field were developed.

At IGCAR, the third batch of forty-five trainee scientific officers, which includes new discipline material science,

successfully completed their training and were placed. During the report period, 50 officers are undergoing training at the Training School. 33 Research Scholars were inducted to pursue their doctoral programmes in the frontier areas of engineering and basic sciences under the aegis of HBNI. Thirteen employees registered to pursue their masters and doctoral degrees with HBNI.

Seventy-five personnel from IGCAR and other DAE units were trained in non-destructive testing such as radiography, penetrant testing and digital industrial radiography techniques.

Seventy students from neighbourhood villages were provided with vocational training of in collaboration with professional bodies and government of Tamil Nadu and 50 with certification in four NDE methods. This increases the employability and also creates trained technical manpower for the projects at Kalpakkam.

Employees of DAE were nominated for various technical and managerial courses/workshops/seminars/symposia/conferences conducted by various organizations, and universities.

### SPONSORED RESEARCH

Board of Research in Nuclear Science (BRNS) is an advisory body of DAE. Besides funding research projects, BRNS provides financial assistance to organise symposia/conferences/workshops on topics of relevance to the

programmes of DAE. BRNS also awards projects to young scientists to initiate them in a career of research and Dr. K. S. Krishnan Research Associateship to identify and encourage highly talented young scientists and technologists. The DAE Graduate Fellowship Scheme (DGFS) is meant for inducting Graduate Level students doing M.Tech. at the IITs. While the Visiting Scientists programme of BRNS is meant for promoting short term in-house interactions amongst senior level experts, the Raja Ramanna Fellowship of BRNS is for reasonably long-term involvement of the eminent scientists and engineers in the various on going programmes of the Department. The Homi Bhabha Chair sponsored by BRNS is instituted to avail the honorable services of Scientists and Technologists who have distinguished themselves at national and international levels.

During the period of this report, 134 new research projects were sanctioned. Financial sanctions were issued for the various on-going research projects. Eight fellowships were offered/awarded under the Raja Ramanna Fellowship Scheme (Senior Scientists Scheme). Six fellowships from the 20th Batch were awarded under the K.S. Krishnan Research Associateship Scheme and another five to seven candidates are likely to be selected from 21st Batch. Twenty two fellowships were awarded under the DAE Graduate Fellowship

## Research Education Linkages

Scheme. Financial supports were extended to fully funded BRNS seminars as well as to partly funded seminars conducted by professional organisations on various topics of relevance to DAE. Under the XIth Plan activities, projects under the Prospective Research Funding (PRF) Scheme are also being awarded under BRNS. Currently, 10 projects have been in progress.

During the Golden Jubilee Year, the Science Research Council (SRC) of DAE had launched a unique programme to encourage exceptionally innovative research and development activities named as DAE-SRC Outstanding Research Investigator Award. Eleven recipients selected for this award continued their research work during 2009-10. In addition, one project was awarded under this scheme during 2009-10.

An MoU was signed with IIT, Delhi for a BRNS sponsored research project on 'Programme in Autonomous Robotics'. The project encompasses vision guided control of a robot manipulator, immersive environment of teleoperation and adaptive control & teleoperation of an industrial robot. MOUs were signed with Jadavpur University for the development of cyclic plasticity models (for materials like carbon steel exhibiting discontinuous material behaviour leading to robust Fatigue Ratcheting Models), studies on large-scale molten material-coolant interaction, clad

behaviour under accident condition and thermal-hydraulics of PHWR channel blowdown and code development for numerical simulation of premixing phase of fuel-coolant interaction in Indian pressurized heavy water reactors. MOUs were also signed with IIT, Roorkee for studies on experimental investigation of asymmetric heating of pressure tubes, experimental investigation of rewetting of fuel rod cluster, Debris bed heat up for PHWR, and experimental investigation of full length pressure tube sagging and ballooning under LOCA with loss Of ECCS condition.

MoU was signed with IIT Kharagpur for the development of generalized procedure for determination of partial safety factors for containment design for all load cases considering uncertainties in material properties and load calculation. MOU was also signed with IIT, Guahati for pressure tube creep correlation development and with MSU, Vadodara for study on vapour pull through for scale down model of PHWR.

An MOU was signed between BRNS - DAE and Guru Jambheshwar University of Science and Technology to develop it as Centre for radioecology in view of proposed Nuclear Power Plant at Hissar, Haryana.

### PROMOTION OF MATHEMATICS

The National Board for Higher

Mathematics (NBHM) was established under the aegis of DAE in the year 1983 with the objective of promoting excellence in higher mathematics education and research in the country.

At the initiative of NBHM the prestigious International Congress of Mathematicians (ICM-2010) will be held at the Hyderabad International Convention Centre, during August 19-27, 2010. Participation of about 4000 delegates from all over the world is anticipated in the event. The preparations are progressing satisfactorily. Various special activities are being planned to supplement the main ICM events.

The regular activities of the Board continued, and some new activities were also introduced. The Board provided scholarships to talented students, selected through nationwide competitive tests, to pursue studies at Masters and Ph.D. Levels. Fellowships were also provided at the postgraduate level, and for teachers at universities to undertake Ph.D. studies. At the undergraduate level a special programme called Mathematics Training and Talent Search is operated, in which selected students from across the country were provided supplementary training by expert mathematicians, during the vacation periods.

Supplementary training activities were also undertaken for selected students at postgraduate level, in a coordinated fashion,

## Research Education Linkages

under the Advanced Training in Mathematics (ATM) programme. Workshops were held for college teachers, to refresh and strengthen their mathematical aptitude. These programmes continued during the current year and have yielded good results.

NBHM has been in charge of the Mathematics Olympiad activity for talented young students at higher secondary (the plus two) level. This activity is conducted with the help of the Homi Bhabha Centre for Science Education (HBCSE). The Regional Mathematics Olympiad (RMO) and the Indian National Mathematics Olympiad (INMO) at the national level are the steps towards selections for the International Mathematics Olympiad (IMO). Students selected from INMO are offered further training in mathematics through a nurture programme for the succeeding 4 years and provided scholarships and cash prizes. A team of six students was selected to participate in the 50th International Mathematics Olympiad (IMO-2009), held at Bremen, Germany. The team secured 3 Silver, 2 Bronze Medals and 1 "Honorable Mention". A new competition is also started this year at the undergraduate level, in Pune and Mumbai, called Madhava Mathematical Competition to generate interest in mathematics in early years of college.

In the financial year 2008-09 the budget allocation to NBHM was Rs 20 Crore (the revised

allocation was Rs 22 Crore). About one fourth of the amount (Rs 5.50 Crore) was released to institutions to support libraries, enabling them to purchase the latest books and journals in mathematics. In addition to this, NBHM distributed selected books to various postgraduate institutions under its book distribution scheme.

NBHM has also been supporting various special mathematical centers in the country, through funding of their activities. The Chennai Mathematical Institute which runs a high quality undergraduate programme in mathematics was a regular recipient of grants from NBHM. In this financial year a first installment of annual grant of Rs.4 Crore was released, and a second installment of Rs.1.3 Crore will be released shortly. The Institute of Mathematics, Bhubaneswar and the Kerala School of Mathematics, Calicut, Bhaskaracharya Pratishthana, Pune, are the other centres being supported by NBHM through support to various programs at the institutions.

The Board also provides grants for promotion of activities in pure and applied mathematics, under several schemes, including support to research projects, travel grants for participation in workshops, conferences, and undertaking collaborative research, funds for organizing conferences etc. During the year financial support was provided to 31 national and international

conferences held in India, and 12 Instructional Schools for advanced training in mathematics. 3 research projects were funded by NBHM. Travel grants were provided to 34 mathematicians to enable them to participate in conferences held in India and abroad. 3 institutions were provided faculty support in the form of Visiting Professors, to strengthen the research and teaching potential at the institutions. Visits (short term) of two expert mathematicians from abroad were also supported during the year.

### *Olympiad Programme*

The International Olympiads in mathematics, physics, chemistry and biology are annual academic competitions to stimulate and challenge bright young pre-college students to excel in their subjects. The aim of the International Olympiads is not only to promote academic excellence but also to foster friendship among different countries of the world through their students and teachers.

The Indian Science Olympiad Programme supported by Department of Atomic Energy, Department of Science and Technology and Ministry of Human Resources Development is doing consistently well.

DAE has provided financial support for organizing Olympiad programmes and for participation in International Olympiads in Physics, Chemistry, Biology



## Research Education Linkages

Mathematics, Astronomy & Astrophysics. The details of medals and Hon'ble mention received by the students during the year 2009 are given below:-

activities of the Atomic Energy Education Society (AEES) have already been elaborated in this document.

The funds (Plan & Non-Plan)

Details	Physics	Chemistry	Biology	Maths	Astronomy	Astronomy & astrophysics	Junior Science Olympiad	Total
Gold	04	-	01	03	04	02	-	14
Silver	01	04	02	-	01	02	05	15
Bronze	-	-	01	02	-	01	-	04
Hon'ble Mention	-	-	-	01	-	-	-	01
<b>Total</b>	<b>05</b>	<b>04</b>	<b>04</b>	<b>06</b>	<b>05</b>	<b>05</b>	<b>05</b>	<b>34</b>

### GRANTS-IN-AID

#### Aided Institutions

The aided institutions of the Department of Atomic Energy are an integral part of the Department in as much as there is a growing synergy between these institutions and the Research and Development Units of the Department. Several joint projects have been undertaken between the Units and Aided Institutions and there is frequent interaction between the academicians of the aided Institutions and the Scientists of the R&D Units. The Department has nine aided institutions fully funded in terms of their recurring and non-recurring expenditure. These institutions are growing at a faster pace in terms of the projects undertaken by them. The

allocated to these Aided Institutions by the Department of Atomic Energy during the financial year 2009 2010 are as under :-

Tripartite Agreement with the North-Eastern Council (NEC) and the Government of Assam, for the revitalization of the Dr. B. Barooah Cancer Institute, Guwahati. This hospital is a Regional Cancer Centre (RCC) for cancer treatment and control in the North-Eastern Region (NER). The Department's total share as per the Tripartite agreement is approximately Rs.1044.70 lakh for revitalization of the BBCI which includes the cost of construction for expansion of the hospital as well as the procurement of major radiation related equipment during its Revitalization Project-III which has been started during the year 2004-05.

The Department also extends

Sl. No.	Name of the Institutions	Budget Provision BE 2009 – 10 (Rs. in crore)
1.	Tata Institute of Fundamental Research (TIFR), Mumbai	335.00
2.	Tata Memorial Centre (TMC), Mumbai	202.60
3.	Saha Institute of Nuclear Physics (SINP), Kolkata	111.16
4.	Institute of Physics (IOP), Bhubaneswar	27.39
5.	Institute of Mathematical Sciences (IMS), Chennai	21.57
6.	Harish-Chandra Research Institute (HRI), Allahabad	25.50
7.	Institute for Plasma Research (IPR), Gandhinagar	288.29
8.	Atomic Energy Education Society (AEES)	47.72
9.	National Institute of Science Education and Research (NISER), Bhubaneswar.	32.00

#### Grants to Cancer Hospitals

The Department of Atomic Energy (DAE) has signed a Third

financial assistance to Cancer hospitals located in other parts of the country. The budget provision for the current financial year for such partial financial assistance is

## Research Education Linkages



*A training session in progress at Administrative Training Institute*

Family Welfare Department of Govt. of Meghalaya for establishment of “DAE-Civil Hospital Cancer Wing” at Civil Hospital, Shillong. For this purpose, DAE has sanctioned an amount of Rs. 26 Crore.

### **ADMINISTRATIVE TRAINING INSTITUTE**

With the aim of Continued Professional Development of officials of various cadres in DAE, the Administrative Training Institute (ATI) had started functioning with effect from July 2, 2007. ATI arranges a wide range of training programmes that cater to a wide spectrum of official needs.

The Institute coordinates sponsoring of officers to Postgraduate Programme in Public Policy and Management by the Indian Institute of Management, Bangalore and Management Development Institute, Gurgaon. This year six officers were sent to MDI, Gurgaon, and 56 Training Programmes were organized.

Most of the programmes were arranged in-house.

to the tune of Rs.20 crore.

An increasing need was also felt to use the expertise available in the DAE funded Tata Memorial Hospital for creating a better network between cancer institutions all over the country. This would include research & development, training and preparation of protocols for treatment as well as incentives for indigenization of much of the radiation related equipment for cancer treatment. For this purpose, an Apex Committee was formed under the Chairpersonship of Director,

TMC. The Apex Committee has met 13 times so far and deliberated on indigenous development and manufacturing of the equipment related to radiation oncology such as Cobalt 60 Teletherapy, Low Energy Linear Accelerator, High Energy Linear Accelerator, simulator development, Brachytherapy.

The initiatives taken to achieve the above stated objectives will lead to further gains in the DAE's outreach in the cancer care programme.

In May 2008, the DAE has signed an MoU with Health &





# Chapter : 7

## Technology Transfer & Collaborative Programmes



*Dr. Srikumar Banerjee, Director, BARC (third from right) and Shri Nitin Desai (fourth from right) MD, M/s Chess Medicare Pvt. Ltd., Mumbai signing Agreement for the transfer of technology from BARC to M/s Chess Medicare Pvt. Ltd., Mumbai for handheld Tech ECG Instrument for Rural Healthcare from BARC*

# Technology Transfer & Collaborative Programmes

## TECHNOLOGY TRANSFER

Following technologies developed by BARC have been transferred to the public domain for further commercial proliferation:

- Backwashable spiral ultrafiltration technology for domestic and industrial water purification.
- Multichannel Acoustic Emission Analyser Technology
- Arsenic Removal from ground/surface water & UF Membrane assisted process technology transferred.
- Hand held Tele-ECG instrument for Rural Health Care
- Image Analysis System (Software for Metallographic Measurements)
- Kitchen waste based bio-gas plant.
- Online domestic water purifier based on ultrafiltration polysulfone membrane technology.

Following technology licenses were renewed:

- License for Boron Carbide technology for M/s Boron Carbide, Mumbai
- License for digital pocket dosimeter

Following collaborative MoUs from various divisions of BARC were signed:

1. Design and development of Helium purification, filling & leak detection facility.
2. IACS-BARC Initiative for research in quantum structures.
3. Technical guidance for setting up test facility for acoustic topography tests on stabilizing wings and panels.
4. Testing of tensile specimens of Nuclear Reactor Materials failure probabilities in ductile to brittle transition temperature range.
5. Fatigue & fracture behaviour of dissimilar metal weld.
6. Studies on low temperature sensitization & low tank thermal embrittlement of narrow gap weld joints of austenitic stainless steel.
7. Fatigue Ratchet behaviour of stainless steel under multiaxial, non proportional loading.
8. Development of solid state nuclear track detectors for charged particle dosimetry.
9. For setting up Isotope Hydrology Centre.
10. Breeder seed multiplication of TG varieties.
11. Commercial use of Krushak Irradiator, Lasalgaon (Tripartite Agreement) BRIT, Navi Mumbai, Maharashtra State Agriculture Marketing Board (MSAMB), Pune and BARC
12. Electron Welding Applications in industry

## BARC-CENTRE FOR INCUBATION OF TECHNOLOGY

The BARC-Centre for Incubation of Technology (BARCIT) at Trombay started functioning with the setting up of four Incubation Cells namely Electron Beam Welding Technology, Water Technology, Food Technology and Medical and Laboratory Equipment Development Technology.

## SOCIETAL INITIATIVES

Following AKRUTIs were set up during the report period:

1. AKRUTI by Loknayak Jayprakash Narayan Leprosy Eradication Trust at Vasai-East, district Thane, Maharashtra.
2. AKRUTI by Malenadu Education and Rural Development Society at Sirsi, district Uttara Kannada, Karnataka.
3. AKRUTI by Shanti Sadhana Ashram (SSA) at Basistha, district Assam, NER.
4. M/s Bhadra Products, Thane signed an agreement for Deployment of Technologies in Rural Sector of Tal. Pandharpur, district Solapur, Maharashtra under AKRUTI Tech Pack.
5. AMD, Shillong participated by setting up 2 AKRUTIs at i) Nongire, Shillong and ii) at Nongmensong in Meghalaya.

# Technology Transfer & Collaborative Programmes



*Photograph showing land for AKRUTI being gifted to Dr. S. Banerjee, Director, BARC by Shri I. Eswara Rao, Executive Director, APIIC, Andhra Pradesh*

With this total 15 AKRUTIs have been set up in six states of India.

BARC-Vizag-AKRUTI APIIC gifted six bits of land totaling 3 acres 14 cent in different locations of Dibbapalem Village, Visakhapatnam.

## **INTELLECTUAL PROPERTY RIGHTS**

DAE-IPR Cell constituted by the Department, works as a nodal agency for all IPR related matters

including filing of patents within India and abroad for all the organizations under DAE's fold.

During the calendar year 2009 the IPR Cell of DAE filed 18 patent applications including 4 in India, 5 under Patent Cooperation Treaty (PCT), 3 in USA, 2 in Canada, and 1 each in South Africa, Japan, Australia and France. During this period, 9 of the previously filed patents have been granted to the Department. This included 4 patents granted by the Controller of Patents in India,

3 by the US PTO and 1 each by the Japan and European Union. The EU patent has been validated in Germany, UK and France, Italy and Sweden. Cumulatively till date, DAE has filed 219 applications including PCT and national phase applications. Out of these, 121 patents have been granted so far, 64 patents are in force at present.

All the applications filed in India in the field of atomic energy are screened and referred to the Department for the applicability of Section 20 (1) of Atomic Energy Act, 1962. During the year, 31 such applications were referred to this department. 24 of these have been reviewed and directions of the department were communicated to the Controller of Patents in India.





# Chapter : 8

## Infrastructure



*Old Yacht Club Building, recently renovated*

# Infrastructure

## PURCHASE & STORES

The Directorate of Purchase & Stores (DPS), a service organization of DAE, caters to the procurement needs of various constituent organisations of the Department.

With the advent of information and communication technology, DPS embarked upon various initiatives to achieve significant improvements in efficiency and productivity. The year of report saw the following major achievements of this Directorate.

### Uranium fuel imports

With the signing of the Indo-US 123 deal and opening of nuclear trade to civil nuclear facilities it has become essential to leverage the enormous experience of DPS with the objective of deriving maximum advantage out of the opportunities created. In pursuance of the same, DPS played a proactive role in finalization of contracts with some of the international uranium fuel vendors such as Areva, France; TVEL Russia and the latest concluded with KAZATOMPROM, a Kazakh Government company. While some of the short-term contracts already stand fully executed part quantities stand supplied in case of other longer duration contracts.

### E-Procurement and other IT initiatives

Various steps were initiated towards harnessing ICT to improve performance of DPS

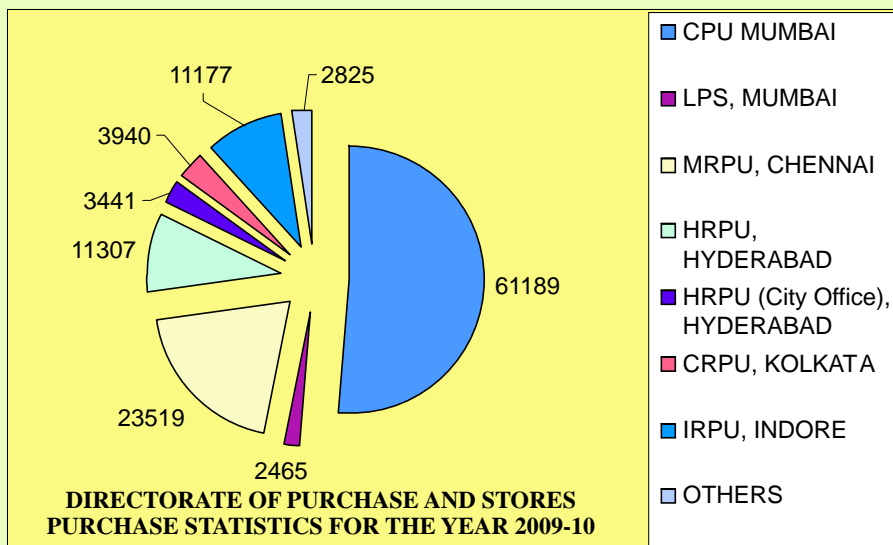

## Comparison of data of years 2008-09 and 2009-10

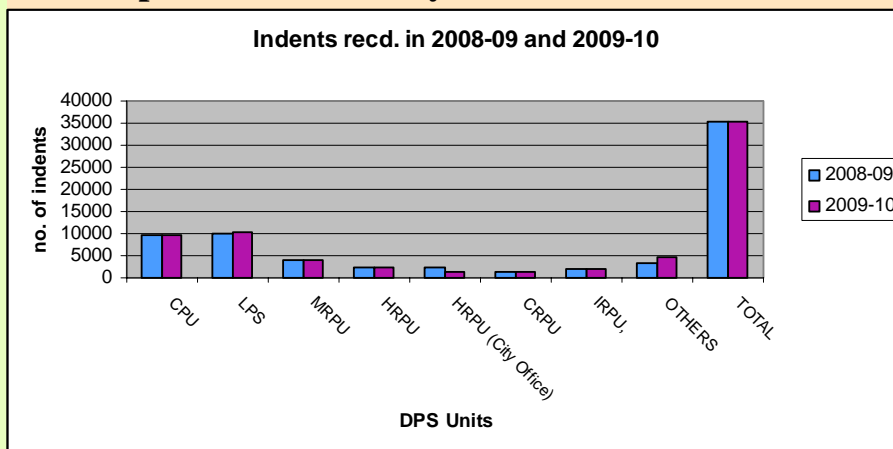

## No. of Purchase Orders placed

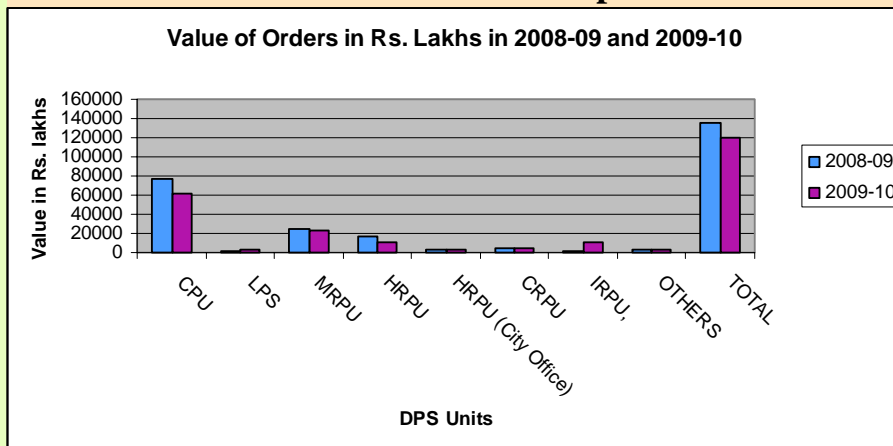



## Infrastructure

without compromising on security concerns. A Steering Committee was constituted for the purpose of drawing a roadmap for implementing e-procurement across various DPS and its regional units.

E-procurement on pilot basis was launched at MRPU. The solution shall be extended to whole of DPS subsequently. The vendor for launch of e-procurement was identified and work on the same was under way. As one of the fundamental prerequisites to the smooth implementation of e-procurement at DPS, a massive exercise towards codification of over 75,000 items has been undertaken.

### ***Purchase Manual Release***

The year under review witnessed one of the most important landmark achievements for DPS with the launch of the Purchase Manual. The 546-page document was released on the Bhabha day, 30th October, 2009.

### **CONSTRUCTION, SERVICES & ESTATE MANAGEMENT**

Directorate of Construction, Services & Estate Management (DCSEM) is responsible to provide residential infrastructure support to the employees of DAE working in Mumbai and to execute construction works for various organisations of DAE including its aided institutions. This Directorate is also responsible for operation and

maintenance of various services, estate management and security for the housing colonies of DAE at Mumbai. This Directorate also takes up project management consultancy for other Central Govt. departments.

During the year of report Video Conference facility for the OYC Building was completed. Balance miscellaneous works for construction of Training School and additional space for HBNI, site development work for OYC buildings, Site development work for residential quarters for CISF personnel were also completed. Repairs of compound walls of the colony, Upgradation of services under XI th plan were in progress and to continue. Pre-qualification for proposed (i) Convention Centre/Sr.Officers Guest House and Administrative Training Institute Complex, (ii) Residential Quarters for CISF personnel, (iii) Hostel for Trainees BARC/HBNI were finalised and tender for the said works to be finalised. Lease agreement with CIDCO for purchasing land for Dispensary at Khargar was under finalisation. Proposal for (i) Construction of 356 residential quarters and (ii) Restoration / renovation of Old houses more than 20 years old Phase-I finalised for obtaining financial sanction.

In addition, DCSEM completed construction of 10 flats for Type V-E and Guest House at Anushaktinagar for TMC, 48 flats of Type III-C at Payalipada for TMC, Compound wall at Rajarhat Campus for VECC at Kolkata, 96

flats at New Mandala for TIFR, LTF building at Colaba for TIFR, Academic Block for NISER at Bhubaneswar and Girls' Hostel for IIT at Powai. DCSEM also handed over Laboratory Block Ph-II, Hostel 2 & 3 to users (NRBC) at Haryana after completion of construction.

The ongoing construction works of DCSEM have been : construction of Housing at Jaipur for AMD, construction of building for Medical Cyclotron for VECC at Kolkata, Integrated facility for Radiation Technology (IFRT) for BRIT at Vashi, Balance development works for 96 flats at New Mandala for TIFR, construction of Physical Training & Aquatic facility for AEES at Anushaktinagar, construction of Girls' Hostel and Sub-Station building for NISER at Bhubaneswar, construction of Auditorium and Flatlets for IIG at Panvel, construction of Type II-B quarters and Type C quarters for IIT at Powai, construction of Girls' Hostel & Cell repository Lab for NCCS at Pune. Works of construction of Computer Centre & Computer Science & Engineering complex for IIT at Powai are to be commenced.

DCSE also took up tendering action for Construction of 80 nos. apartment for QIP for IIT at Powai, construction of 3rd floor of School-6 at Anushaktinagar and Pre-qualification for Academic Township and Residential Township for NISER at Jatni.

This Directorate maintains residential flats (9821) and public

# Infrastructure

buildings of DAE in Mumbai including execution of upgradation works required for the buildings which are of minor capital in nature. The upgradation jobs of existing services taken up were electrical power distribution, lifts, water supply distribution, sewer lines, sewage treatment plant, fire fighting system, rain water harvesting and energy conservation of the services in the large township at Anushaktinagar.

The Estate Management Section of this Directorate continued to manage the estate of DAE and allotment of residential flats, shops including public buildings and the security for the DAE Estates in Mumbai.

During the year of report schemes worth Rs. 65.00 Crores are being completed for various DAE units and other department, including projects for DCSEM worth Rs. 15 crores.

## GENERAL SERVICES

The General Services Organisation (GSO) at Kalpakkam looks after various common services such as estate management, transport, guest house, civil construction as well as maintenance and electrical maintenance, water supply, auto garage, hospital and other amenities in Kalpakkam.

GSO carried out maintenance as well as construction activities pertaining to civil works at both the townships, and essential auxiliary services. Following works were executed during the report period :

- Construction of UGC-DAE-CSR building and additional rooms for MEHATVA at Kalpakkam Township, AEC School (Phase IV) and additional class rooms for

AECS-II at Sadras.

- Modification & improvement work for IGNOU and Shankara college, etc. at Kalpakkam Township.
- Completion of in-house architectural design for 120 Nos. of Efficiency Apartments.
- Maintenance of residential / non-residential buildings and infrastructures both Kalpakkam and Anupuram Townships.
- Planting and maintenance of Bio-shield coastal plantation.

GSO looked after allotment of residential quarters in Kalpakkam and Anupuram Townships numbering 4919 & 933 respectively.

# Chapter : 9

## Public Sector Undertakings (Financial Performance)



*SCADA System developed by ECIL for the Uranium Corporation of India Ltd.*



# Public Sector Undertakings (Financial Performance)

The Nuclear Power Corporation of India Ltd., Bhartiya Nabhikiya Vidyut Nigam Ltd., Uranium Corporation of India Ltd., Indian Rare Earths Ltd. and Electronics Corporation of India Ltd. are the five public sector undertakings of DAE. Operational highlights of these organizations (except of ECIL), have been given under the related major programme heads. The financial performance of these undertakings (except BHAVINI which is yet to commence commercial operations) in addition to the gist of performance of ECIL, are presented below.

## ***Nuclear Power Corporation of India Ltd.***

The provisional net profit (PAT) for the year 2009-10 (upto December 31, 2009) was Rs.303 crore. The profit has been lower in view of low generation on account of fuel supply that continued to be constrained during the year. NPCIL bonds continued to be rated at AAA (Highest Safety) by CRISIL and CARE.

## ***Uranium Corporation of India Ltd***

The overall performance of UCIL during the year 2008-09 continued to be satisfactory. The turnover of the company increased up to Rs.397.29 crore as against Rs.303.12 crore in the previous year, posting a 31% rise. The net profit stood at Rs. 18.01

crore against Rs.14.63 crore in the previous year.

## ***Indian Rare Earths Ltd.***

During the year 2008-09, the sales turnover IRE was Rs.336.56 crore against Rs. 295.97 crore in 2007-08. Its profit before tax in 2008-09 was Rs.82.88 crore against Rs.228.76 crore in 2007-08. IRE earned foreign exchange of Rs. 48.19 crore and foreign exchange earnings for the current year (up to November'09) have been Rs. 31.50 crore. The Company has paid 20% dividend amounting to Rs.17.27 crore for both the financial year 2007-08 and 2008-09.

The actual sales turnover up to November,2009 is Rs. 199 crore against Rs.200 crore achieved during the corresponding period of last year. The sales turnover for the year 2009-10 is expected to be around Rs.300 crore.

## ***Electronics Corporation of India Ltd.***

ECIL, the electronics arm of the DAE, while successfully achieving the primary objective of meeting the requirements in the field of Control & Instrumentation for the Indian Nuclear Power Programme, emerged over the years as an important national asset in the field of Strategic Electronics. The pioneering efforts made by the Corporation from its formative period enabled it to realize several

noteworthy products and systems needed in the strategic domains of atomic energy, defence, space, aviation and security sectors, in addition to various other fields of economic significance to the country.

ECIL has achieved a production of Rs.577 crore and a net sales of Rs.523 crore upto December 2009 as compared to Rs.744 crore and Rs.679 crore respectively for the corresponding period during 2008-09.

Important supplies made during the year 2009-10 in the Strategic Sectors were as follows :

### Atomic Energy Sector :

- Control & Instrumentation packages to Bhavini
- Power Supplies to BARC
- PDCS System and other supplies to RAPP, Kota
- I&C jobs of KAPP, Kudankulam
- Security Systems to NAPS

### Defence Sector :

- Fuzes to MoD
- V/UHF and HF Transceivers to MoD
- Speech Secrecy Equipment to MoD
- Execution of Project Divyadrishti to MoD
- Solid State Cockpit Voice Recorders (SSCVR) to Air HQrs.
- Gyro Stabilized Horizontal Bar System to NHQ

### Space Sector :

# Public Sector Undertakings (Financial Performance)



*Mobile 3.8 m Data Dissemination Terminal developed by Electronics Corporation of India Limited.*

Project KAVERI (Revenue Dept., Govt. of Karnataka)

- Electronic Voting Machines (EVMs) to Election Commission
- SCADA Equipment to Oil and Gas Pipelines
- Electronic Energy Meters to West Bengal Electricity Board
- Turbine Control Panels and Electrical Position Transmitters to BHEL

### *National Population Register Project*

The Government of India has decided to create National Population Register (NPR). The initiative is being carried out in phases by Registrar General of India (RGI), through a Consortium of PSUs including ECIL. In the present phase, all the coastal districts of the country are being covered for issue of

- 11M Earth Station Antenna to ISTRAC
- 7.5M Full Motion Antenna to IRNSS project of ISTRAC

Projects for Maharashtra Sales Tax Department

- Execution of e-Governance

### Security Sector :

- Integrated Security Systems to Delhi Secretariat
- Surveillance Systems to Delhi Markets
- Integrated Security Systems to Common Wealth Games (progressing)
- X-ray Baggage Inspection Systems to various important installations
- Maintenance of Security System(s) at Parliament House

### Other Sectors :

- Execution of e-Governance



*PC based whole body contamination monitor*



# Public Sector Undertakings (Financial Performance)



*Radiation Monitoring System for Vehicles*

## *Quality Management Systems*

ECIL achieved certification as per relevant international standards for its Quality Management (ISO9091:2010), Environmental Management (ISO14001:2004), Occupational Health and Safety (OHSAS 18001:2007) and Calibration (ISO 17025:2005). Information Security System as per ISO27001 is under implementation to realize certification during 2010.

## *Outlook for 2010-11*

The Company is geared-up to handle the following business areas in the coming year.

## *Atomic Energy*

- Completion of C&I supplies for PFBR

Citizenship cards.

## *R&D Programme*

The in-house R&D programme of the Corporation is guided and supported by the Technology Development Council, BARC. The following projects are planned for completion during 2009-10:

- Ka-band Suitcase Antenna
- Grid Middleware and Application Development
- Migration of Techcom Simulator TIS from Alpha Servers to Itanium Servers
- Generic Command & Control Systems
- Portable Calorific Value Meter
- OPC Interface to SCADA
- FPGA based on Board Mission Computer

- Air Traffic Services (ATS) Message Handling System (AMHS) with AFTN Gateway

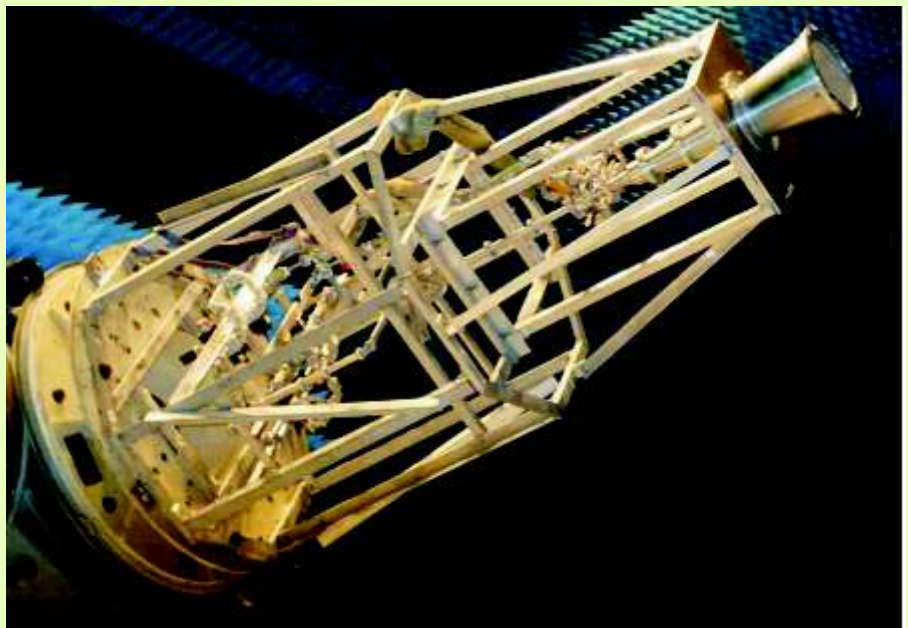

*Ku-DBS Multimode Monopulse Tracking Filled*



# Public Sector Undertakings (Financial Performance)

- Completion of type testing of C&I packages for B1, B2 projects
- Installation & Commissioning of C&I for KKNPP-1&2
- Indigenisation of certain C&I packages for KKNPP-3&4
- Supply of SCADA and Radiation Monitoring Equipment for Reprocessing facilities

## *Defence*

- Electronic Warfare (EW) Systems
- UHF / VHF Radio Communication Equipment
- Missile Support Systems for

- BrahMos
- Electronic Fuzes
- Mobile Surveillance and Reconnaissance Systems (MSRS)
- Antenna Platform Units for LCAMulti-mode Radar

## *Space*

- Integrated Communication Network System (ICNS) for ISRO
- Weather Radars for IMD
- 18M Antenna Systems for DRDO
- MACE Telescope for Gamma Ray Astronomy
- 

## *Security*

- Integrated Security Systems and CBRN Detection Equipment for Common Wealth Games
- Radiation Monitoring and Detection Equipment for major Sea Ports
- Video Surveillance Equipment for Delhi Markets and Borders



# Chapter : 10

## Other Activities



*Signing of MoU between NPCIL and Westinghouse Electric Ltd. of USA*



# Other Activities

## NATIONAL SECURITY

B A R C c o n t i n u e d implementation of the necessary research and development as well as manufacturing activities required for national security.

## CRISIS MANAGEMENT

The Crisis Management Group (CMG) is a standing Committee of senior officials of DAE who are responsible for coordinating the Department's response to a radiation emergency in the public domain. Such an emergency could be due to events taking place within any nuclear facility, due to an accident involving the transport of nuclear material, due to events at other facilities handling radioactive materials such as hospitals or industries, or even due to any deliberate attempt to cause disruption in public activities, by involving radioactive material. Because of the inherent design features and deployment of multiple safety systems, the possibility of any accident in a nuclear facility or during transport which might lead to a radiation emergency in the public domain, is highly remote. However, to handle any unforeseen situation, formal emergency response systems are in place and are tested regularly to ensure that there would be no radiation hazard to the public. All these activities are overseen by an independent regulatory authority, which ensures that all radiological

safety issues are adequately addressed. Further, in case such an unlikely event does occur and leads to a radiation emergency in the public domain, a response system is in place to tackle such situations, by mobilizing the expertise of DAE in the field of radiation measurement and protection and medical treatment of radiation injuries. The objective is to make these specialized technical support facilities available to public officials who would be handling various types of disasters or emergencies in the public domain.

To ensure that the emergency plans are in high state of readiness, major nuclear facilities like nuclear power stations and hydrogen sulphide based heavy water plants periodically carry out a variety of emergency exercises. During the year 2009, the following exercises were carried out:

1. C o m m u n i c a t i o n Exercises	-	285
2. F i r e E m e r g e n c y Exercises	-	79
3. P l a n t E m e r g e n c y Exercises	-	39
4. S i t e E m e r g e n c y Exercises	-	10
5. O f f - S i t e E m e r g e n c y Exercises	-	5

The Off Site Emergency Exercises were carried out in the public domain in the vicinity of nuclear power stations at Tarapur in Maharashtra, Rawatbhatta in Rajasthan, Kalpakkam in Tamil Nadu, Kaiga in Karnataka and of

the heavy water plant at Manuguru, Andhra Pradesh. These Off Site Exercises were conducted by the concerned district officials (the District Magistrate or Collector is the Off Site Emergency Director) and information flows were established to the CMG as well as to the National Crisis Management Committee of the Union Government. The external observers for these exercises included among others, senior officials from the National Disaster Management Authority (NDMA) and the Cabinet Secretariat.

The same system is also available to respond to a request from any public official in the event of the reported presence or suspected presence of radioactive material. For this purpose, guidelines have been circulated to all State Governments and Union Territories. A significant component of the emergency response system of DAE is the availability of two emergency communications rooms at Mumbai, which are manned on a round the clock basis throughout the year. These have multiple modes of communication and are in constant contact with various nuclear facilities in the country as well as with the International Atomic Energy Agency (IAEA) in Vienna.

The CMG also provided its expertise in various forums in the field of disaster management at both National and International levels.

## Other Activities

### BARC SAFETY COUNCIL

BARC-Safety Council continued its regulatory function to ensure the safety of all the plants and facilities under its purview.

### SCIENCE RESEARCH COUNCIL

DAE-Science Research Council, consisting of eminent scientists, continued with the peer reviews of basic research to ensure that highest possible level of excellence is maintained.

### INTERNATIONAL RELATIONS

Bilateral agreements signed during the year 2009-10 are as follows:

(i) Agreement between the Government of the Republic of India and the Government of Republic of Namibia on cooperation in Peaceful Uses of Nuclear Energy signed on 31 August 2009.

(ii) MoU between the Government of the Republic of India and the Nuclear Energy Agency, Regulatory Agency of the Government of Mongolia on cooperation, in the field of Peaceful Use of Radioactive Minerals and Nuclear Energy signed on 14 September 2009.

(iii) Agreement for cooperation between the

Government of the Republic of India and the European Atomic Energy Community in the field of Fusion Energy Research signed on 6 November 2009.

(iv) A joint declaration by India and the United Kingdom on Civil Nuclear Cooperation was signed on 11 February 2010.

India is a designated member of the Board of Governors (BoG) of the International Atomic Energy Agency (IAEA) since its inception. Besides the General Conference of IAEA, India participated in other important meetings including Board of Governors, Programme and Budget Committee, Technical Assistance and Cooperation Committee etc., also represented in 31 committees of IAEA related to safety, safeguards, nuclear engineering and applications.

India continued to offer training facilities, fellowships, and scientific visits etc. to various countries and trained 11 IAEA fellows. India also made available the service of 19 scientists as experts to various countries under the IAEA Technical Co-operation scheme in the field of peaceful uses of atomic energy.

Under the Indo-German Bilateral Agreement, 9 Indian Scientists visited Germany and 5 German scientists visited India.

Around 2500 foreign scientists and a number of Indian scientists/engineers participated in the international symposia,

workshops, conferences and meetings held in India under the auspices of the IAEA and various international/multinational organizations. India hosted 18 IAEA and 60 non-IAEA meetings/symposia on important issues such as pressurised heavy water reactor fuel modeling, workplace monitoring, safety analysis in support of event investigations, physical protection of radioactive sources, mutant multi-locations trails & mutations enhancement of genetic diversity, molecular tools for quality improvement in vegetatively propagated crops including banana and cassava etc.

Over 900 scientists from India were deputed abroad to attend international symposia, workshops, conferences and meetings conducted by IAEA and non-IAEA organizations.

### *International Conference*

To commemorate the occasion of the Birth Centenary of Dr. Homi Jehangir Bhabha, the founder of the Atomic Energy Programme in India, the Department of Atomic Energy in cooperation with International Atomic Energy Agency (IAEA) organized an International Conference on "Peaceful Uses of Atomic Energy-2009" during September 29 October 1, 2009 in New Delhi. Dr. Manmohan Singh, Hon'ble Prime Minister of India, Dr. Mohamad ElBaradei, Director-General, International Atomic Energy Agency, Prof. P. Rama Rao, President, Indian

## Other Activities



*Inauguration of International Conference on Peaceful Uses of Atomic Energy, 2009 held at Vigyan Bhavan, New Delhi during September 29 - October 1, 2009. Seen from R to L: Dr S. Banerjee, Dr. Anil Kakodkar, Dr. Mohamed ElBeradie the then Director General of IAEA, Dr. Manmohan Singh honorable Prime Minister of India, Mr. Pranab Mukherjee Finance Minister, Dr. P. Ramarao, President Indian Nuclear Society and Dr. A.V. R. Reddy, Secretary, Technical Committee, ICP UAE-2009*

Nuclear Society, Dr. Anil Kakodkar, Chairman, Atomic Energy Commission participated in the inaugural ceremony of the Conference. Around 850 delegates attended this Conference.

### **World Nuclear Association**

Three units of DAE i.e. NPCIL, NFC and AMD are members of the World Nuclear Association (WNA), a global non-governmental trade organization concerned with nuclear power generation and all other aspects of the nuclear fuel cycle. WNA also fosters commerce and co-operation within the nuclear industry in promoting the cause of nuclear energy in trans-national

fora. DAE scientists took active part in various WNA activities including in their Summer School.

NPCIL organised on 6 October 2009 a half day orientation seminar on the WNA's 2009 nuclear fuel market report "The Global Nuclear Industry Today". The Corporation also joined WNA's two working groups on Nuclear Fuel, and Waste Management And Decommissioning.

### **India-Specific Safeguards Agreement**

The Agreement between the Government of India and the IAEA for the Application of Safeguards to Civilian Nuclear Facilities has also been signed in

Vienna on 2nd February 2009. The Safeguards Agreement with IAEA has through a written notification by India as per Article 108 of the Agreement, entered into force on 11 May 2009. The Agreement has been circulated by the Agency as INFCIRC/754. The following facilities are subject to Safeguards under the Agreement between the Government of India and the International Atomic Energy Agency for the Application of Safeguards to Civilian Nuclear Facilities.

1. Uranium Oxide Plant (Block A), NFC, Hyderabad
2. Ceramic Fuel Fabrication Plant (Pelletizing, Block A), NFC, Hyderabad



## Other Activities

3. Ceramic Fuel Fabrication Plant(Asembly, Block A), NFC, Hyderabad
4. Enriched Uranium Oxide Plant, NFC, Hyderabad
5. Enriched Fuel Fabrication Plant, NFC, Hyderabad
6. Gadolina Facility, NFC, Hyderabad
7. TAPS-1- Tarapur Atomic Power Station, Unit 1
8. TAPS-2- Tarapur Atomic Power Station, Unit 2
9. RAPS 1 - Rajasthan Atomic Power Station, Unit 1
10. RAPS 2 Rajasthan Atomic Power Station, Unit 2
11. KK 1 Kundankulam Nuclear Power Plant, Unit 1
12. KK 2 Kundankulam Nuclear Power Plant, Unit 2
13. RAPS 5 Rajasthan Atomic Power Station, Unit 5
14. RAPS 6 Rajasthan Atomic Power Station, Unit 6

### ***The Additional Protocol***

'Protocol Additional to the agreement between the Government of India and the International Atomic Energy Agency for the Application of Safeguards to Civilian Nuclear Facilities' was approved by the IAEA Board of Governors on 3 March 2009. The Additional Protocol was signed on 15 May 2009. The Additional Protocol has not entered into force.

### ***India's International Co-operation in Civil Nuclear Energy***

A meeting of the India-United States Civil Nuclear Energy

Working Group (CNWG) was held in Mumbai on 3-4 February 2010. The meeting was co-chaired by Dr. R.B. Grover, Director, Strategic Planning Group, DAE and Dr. Warren "Pete" Miller, Assistant Secretary for Nuclear Energy, Department of Energy, USA. The co-chairs signed a U. S- India Civil Nuclear Energy Action Plan which provides a path forward and timeline for execution of collaborative works in specific technical areas.

### ***European Organization for Nuclear Research***

India is an observer in the European Organization for Nuclear Research (CERN) and continued their co-operation concerning collaborative work in the framework of the developments of computing and computational Grid technology for Large Hadron Collider Project (LHC) based on the 1991 agreement. India intends to continue being part of the computing Grid Project of CERN and to make contributions to be mutually agreed between the two sides and to prolong the protocol upto 31st December 2010.

### ***World Association of Nuclear Operators***

NPCIL continued to be a member of various international organizations viz. World Association of Nuclear Operators (WANO), Candu Owners Group (COG) and World Nuclear Association (WNA). NPCIL actively participated in various

programmes of these organizations to enhance the safety and reliability of its nuclear power plants.

NPCIL is one of the founding members of WANO and is currently member of three WANO regional centres at Tokyo, Moscow and Atlanta. WANO was established in 1989 with the mission to maximize the safety and reliability of the operation of nuclear power plants. All the nuclear power plants operating in over 30 countries of the world are its members. Dr. S.K. Jain, Chairman & Managing Director, NPCIL, had been the President of WANO till recently. From 31st January to 2nd February 2010, NPCIL hosted WANO Biennial General Meeting, a prestigious events of WANO, in New Delhi. In this meeting about 350 Chief Executive Officers of various nuclear power plants, industries involved in nuclear business and WANO Chairman, President, Governing Board members and Directors of WANO regional centres participated.

During this year NPCIL hosted WANO Peer Review of RAPS-2, RAPS-3&4 and KGS-1&2, which were carried out by experts from about eight countries and found to be very useful in bringing out areas which needs improvement from international perspective. This also provided opportunity to learn international good practices. Also, WANO organised five Technical Support Missions on the areas for which NPCIL desired further improvement through

## Other Activities

WANO to learn from international practices and experience to strengthen its own programmes. About 15 officials of NPCIL participated in the meetings, seminars and peer reviews organized by WANO and had the opportunity to discuss various issues related to improvement in plant performance with experts from other countries.

### MANAGEMENT SERVICES

The Management Services Group (MSG) provides project monitoring, information services, computer network and systems support at the DAE Secretariat.

During the year 2009-10, the information system to monitor the progress of major projects of Units of DAE during the XI Plan was updated periodically and reports highlighting the expected schedule and costs were generated when required by the top management.

The Group continued to coordinate the monthly meetings of the Steering Committee for Nuclear Power Programme that monitors linkages of all Nuclear Power Programme related activities of DAE.

MSG also maintains a comprehensive information system on the performance of all the operating units under DAE. Based on these information systems periodic reports were sent to the Prime Minister and the Atomic Energy Commission.

MSG continued to provide Information Technology (IT)

facilities on a round the clock basis to the DAE headquarters. It also provided support for video conferencing across all the Units of DAE.

The Group maintains the Internet information portal for the Indian Atomic Energy Programme through the DAE web site (<http://www.dae.gov.in>). The website is a repository of various publications, achievements of the department, Atomic Energy related acts and rules in force and provides downloadable forms for the benefit of the public.

During the year, the group implemented the latest Office Procedure Automation (OPA) software for monitoring the movement of files in the Secretariat. The group is continuously upgrading the IT infrastructure in DAE Secretariat so that state-of-the-art facilities are made available to the users.

The Group continued to coordinate the functioning of the Computer Information and Security Audit Group (CISAG) constituted for the purpose of overseeing the security of the entire Department's IT infrastructure. The CISAG prepares periodic exception reports on IT security based on internal audit reports received from all the units for submission to Home Ministry and Chairman, AEC.

MSG participated in various committees and task forces of the department in the field of Planning, Project monitoring and Information technology. It also

continued to provide support to the Crisis Management Group (CMG) of DAE for carrying out its functions.

### VIGILANCE

The overall responsibility of vigilance activities rests with the Chief Vigilance Officer (CVO) of DAE. To facilitate proper functioning of the vigilance machinery and to establish effective co-ordination amongst the organizations, a senior officer in each Unit was designated as Vigilance Officer for vigilance functions. In the DAE's Public Sector Undertakings such as ECIL, IREL and NPCIL, full time CVOs are available to co-ordinate the vigilance activities.

Vigilance functions included timely transmission of various vigilance returns to the Central Bureau of Investigation (CBI), Department of Personnel and Training (DP&T)/Central Vigilance Commission (CVC), issuance of prosecution sanctions, processing of vigilance & disciplinary cases, monitoring of the progress of inquiry proceedings, investigation of complaints and others.

An Annual Action Plan is worked out by all DAE units. As advised by CVC, two specific areas prone to corruption (i.e. tendering, disposal of scrap material, recruitment of personnel etc.) were identified by each Unit and concerted action is being taken.

As per the directives of CVC,

## Other Activities

Vigilance Awareness Week was observed from 3.11.2009 to 7.11.2009 in the Department as well as its Constituent Units, Public Sector Undertakings and Aided Institutions, by taking the vigilance pledge, arranging lectures, essay competitions, quiz competitions, drawings etc. on vigilance awareness.

Auditing of the transactions of the Department was carried out regularly by concerned agencies.

### OFFICIAL LANGUAGE IMPLEMENTATION

DAE and its constituent organisations, PSUs and aided institutions continued to carry out their activities for promotion of the use of Rajbhasha Hindi in varied disciplines of nuclear science and technology. Some of the efforts made in this direction were as follows:

- DAE conducted the 12th All India Rajbhasha Sammelan on November 4-5, 2009 at VECC, Kolkatta and various lectures and programmes were organized there.
- IGCAR with the collaboration of DAE as well as the Commission for Scientific and Technical Terminology, Ministry of Human Resource Development, brought out a bilingual (English-Hindi) Nuclear Glossary containing more than 8,500 Scientific and Technical Words. The same was released on the occasion of the 12th All India Rajbhasha Sammelan.
- Under the Incentive Schemes of DAE, Rajbhasha Shields for the year 2008-09 were given to AMD, Hyderabad; NPC, Mumbai and IRE, Mumbai jointly; and IPR, Gujarat and TMC, Mumbai jointly, for the excellent progress made in the implementation of Official Language Policy. The Shield for bringing out the best House Magazine was given to NAPS, and Certificates to RAPS, Rawatbhata; KAIGA Generating Station and BARC, Mumbai.
- 20 Seminars and 61 Talks in Hindi on diverse subjects, mostly related to nuclear science were organized and the Souvenirs in Hindi on the proceedings of the Seminars/Conferences were brought out.
- All Gazette Notifications, Cabinet Notes, Reports and other documents furnished to various Committees of the Parliament, and the Agreements and MoUs were prepared bilingually.
- 1,361 Officials were imparted training in Hindi Noting and Drafting in Hindi Workshops. Cash awards were given to 472 Officials for writing original notes and drafts in Hindi.
- 411 Officials, 92 Typists and 12 Stenographers were imparted training in Hindi, Hindi Typing and Hindi Stenography respectively. 493 Officials, 103 Typists and 87 Stenographers were undergoing training in Hindi, Hindi Typing and Hindi Stenography respectively. 340 Officials, 37 Typists and 12 Stenographers were given cash awards and other incentives for successfully passing Hindi, Hindi Typing and Hindi Stenography examinations.
- Hindi books worth Rs. 6,75,253/- were purchased and books worth Rs. 3,45,577/- were to be purchased.
- Quarterly meetings of OLICs were held regularly. Progress of implementation of Hindi was monitored through OLIC meetings and Quarterly Progress Reports were reviewed.
- DAE and 19 of its establishments have their Websites in bilingual form.
- There were 16,847 bilingual computers and another 884 bilingual computers were to be purchased.
- The Hindi Vigyan Sahitya Parishad, a voluntary organization of BARC continued to publish a popular Hindi quarterly bulletin "Vaigyanik". Pamphlets on various subjects related to DAE's activities were also prepared in bilingual form.
- 32 House Magazines and 4 News Letters were brought out by various establishments of DAE. In addition, one "Bulletin on Highlights" was also published by one of the constituent units of DAE.



## Other Activities

- Parliamentary Committee on Official Language inspected RRCAT, Indore.
- The total strength of Hindi Staff in DAE and its constituent Units, PSUs, and Aided Institutions is 123.

### SCIENTIFIC INFORMATION RESOURCE

At BARC, planning and implementation of the concept of the electronic library, were vigorously pursued, to provide various library-based services to scientists and engineers. Both the e-portals, Lakshya and Saraswati were upgraded and these facilities were extensively used by researchers. This year, about 900 new books; 500 S&T Reports; 1450 journal titles (both online and print versions and back volumes of several journals) were added to the library collection.

Services such circulation, inter library loans, membership, reprography, videography/photography, reference and other services were provided to users.

BARC Newsletter, Nuclear News Digest, Transbulletin and several Internal and External Reports were published during this year. Various technical reports from Russian, French, German and Japanese were translated into English to enable our researchers to continue their R&D activities.

Annual inputs of nuclear information from India were provided to the INIS database, logistic support for the implementation of RCA projects

in India during the year, continued.

At IGCAR, the 'Front-Desk Operation' at the RFID based Circulation Counter was made full-fledged IT enabled and secured. The facility of Self Check-In and Checkout of documents using the RFID-enabled Kiosk is introduced for the users.

Provision for accessing in-house published full-text documents such as Newsletters, Annual Reports, Internal Reports, peer-reviewed articles and conference papers and dissertations and theses of IGC-Scholars were made in Library Home page. Table of Contents of newly added books' are also made available.

At AMD, procurement of books and subscription of periodicals were continued. Selected scientific papers from different journals were listed and disseminated among officers.

206 scientific abstracts/papers were scrutinized and 194 were approved for presentation in various seminars / symposia / conferences / workshops and publication in journals.

Exploration and Research for Atomic Minerals (EARFAM), Vol. 18 & 19 was published.

Scientific Information Resource Centre (SIRC) of DAE plays an important role in fulfilling the technical and scientific information requirements of the Secretariat. The Information resource of SIRC was strengthened by the addition

of new books, periodicals and Audio-Visual materials etc. User services such as circulation, news clipping (News Watch), referrals, inter-library-loan, reprography, etc. were provided to the senior officials and other users of DAE. During the year, SIRC also provided assistance to the publication activities of the Department.

### PUBLIC AWARENESS

DAE and its organisations continued their efforts for creating mass awareness about the various programmes of the department and their societal impact. These efforts were also directed to remove the myths and misconceptions prevalent in public about atomic energy and radiation. Additionally, a large number of programmes were organised in connection with the Birth Centenary of Dr. Homi Jehangir Bhabha. DAE and its units organised and participated in a number of exhibitions, seminars, workshops and essay and quiz contests.

As part of the Bhabha Centenary celebrations, an International Conference on Peaceful Uses of Atomic Energy was held in collaboration with the International Atomic Energy Agency and Indian Nuclear Society, at Vigyan Bhavan, New Delhi, during September 29-October 01, 2009. During the conference, an exhibition on the programme, achievements and future plans of DAE was put up

## Other Activities



*Participants of the 21st DAE All India Essay Contest with Shri V.K. Raina, Director, Reactor Group BARC and Shri S.K. Malhotra, Head, Public Awareness Division, DAE*

January 3-7, 2010. DAE put up a grand pavilion with displays on its entire spectrum of activities along with interactive models, dynamic panels, scrollers and samples. The pavilion was visited by about one lakh people including large number of students and many dignitaries. The DAE pavilion was adjudged as the Most Interactive Pavilion of the expo.

The 21st DAE All India Essay contest on Nuclear Science & Technology was organised during October, 2009. The three topics for the essays were “Expanding Indian Nuclear Power Programme -- Realising Dr. Bhabha's Vision”, “Reaping the Benefits of Radiation Technologies Dr. Bhabha's Vision, Growth and Current Scenario in India” and “Laser and its applications”.

and an expo demonstrating growth of nuclear science and technology in India, was also organised. The conference was attended by about 850 delegates including a large number of foreign delegates.

A Bhabha Centenary Symposium on “Science and Technology at the Frontiers” was organised by TIFR and DAE, in Mumbai, during December 03-05, 2009 with large Indian and foreign participation. During this, a permanent exhibition on Bhabha's life was set up by TIFR at their premises. Another permanent exhibition on Bhabha was setup by DAE at Kenilworth the birth place of Dr. Bhabha. 12 exhibitions on Dr. Homi Bhabha's life were arranged at Mumbai and various other places in India.

A S&T Expo 'Pride of India' was organised at the Kerala

University, Thiruvanthapuram in parallel to the 97th session of Indian Science Congress during



*Dr. Farooq Abdullah, Honorable Minister of New and Renewable Energy, Govt. of India at the DAE pavillion at India Nuclear Energy-2009 held at Mumbai*





*Shri Prithviraj Chavan Hon. Minister of State, Science & Technology and Dr. S. Banerjee, Chairman, AEC, and a DAE official, at the DAE pavillion at Indian Science Congress at Thiruvananthapuram*



*Inauguration of Vidnyan Jagar-2010 organized at Dapoli in Maharashtra*



*Students at the DAE pavillion at Indian Science Congress at Thiruvananthapuram*



*Children curiously looking at the model of a Nuclear Reactor at Vidnyan Jagar-2010 at Dapoli*



## Other Activities

Large number of essays were received and the 36 shortlisted students were invited to be DAE's guests during October 22-31, 2009. They were shown around various DAE facilities in and around Mumbai. After an oral presentation, first, second and third prizes were awarded for every topic.

A series of eight seminars were held in different parts of country for farmers, agriculturists and general public, in collaboration with the Indian Space Research organisation (ISRO) and Confederation of Indian Farmers Association. The venues were university of Agricultural Sciences, Bangalore, Punjab Agricultural University, Chandigarh, Indira Gandhi Rural University, Raipur, Jammu Club, MA Stadium, Jammu, College of Agriculture, Nagpur, Jawaharlal Nehru Krishi Vishwa Vidyalay, Jabalpur, P. Kamaraj Krishi Vigyan Kendra Pondicherry and Tamil Nadu Agricultural University, Coimbatore.

Public Awareness Seminars and exhibitions were held at Latur, Maharashtra (May, 2009), Nalgonda, A.P.(July, 2009), Thiruvananthapuram, Kerala (December, 2009), Dharwad, Karnataka (August, 2009) etc. DAE also participated in following S&T exhibitions : Bangalore Bio - 2009 (June, 2009), Bihar Gyan Vigyan Expo, Muzaffarpur, Bihar (October, 2009), Pancham 2 Exposition, Vadodara, Gujarat (December, 2009), A S E T S - 2 0 0 9 ,

Thiruvananthapuram, Kerala (Dec.2009),Metals & Minerals Expo, Science City, Kolkata (November, 2009), India Nuclear Energy , 2009, Mumbai (November, 2009), Dnyan Vidhyan Mahotsav, Thane (January, 2010), Vidnyan Jagar 20101, Dapoli, Maharashtra (January, 2010), Science Fiesta 2010, Panaji, Goa (February, 2010)

Financial assistance was provided for organising various scientific awareness programmes such as Prof. Brahm Prakash Memorial Materials Quiz at Kalpakkam, INS National Seminar on Nuclear Science & Technology, Thapar University, Patiala, Punjab, a 10-lecture series organised by the Indian Women Scientists Association, Vashi, Navi, Mumbai etc.

At Trombay, National Technology Day was celebrated on 11th May 2009. The Graduation Function of 52nd batch of BARC Training School was held on August 26, 2009. Also, the 100th Birth Anniversary of Dr. Homi Bhabha was celebrated on 30th October, 2009 as Founder's Day.

Various national & international symposia, Trombay colloquium and theme workshops were organized during this year. BARC Officer's Association (BARCOA) with Board of Research in Nuclear Sciences (BRNS), held a symposium on "BARC Technologies for Development of Rural India". Students & faculty members from

different colleges all over the country visited BARC. Armed Forces officials, Officials from different wings of Navy & Air force, Officers from Military Engineering College visited BARC.

A programme on Atomic Energy in National Development was organized by DAE, BARC & Dayanand Science College, Latur on the occasion of Dr. Bhabha Centenary Year, on May 23-24, 2009. Five public awareness programmes at various educational institutions on Nuclear Energy for National Development were organized.

NPCIL carried out a variety of programmes disseminating information, about the company and various aspects of nuclear power among students, members of public, decision-makers, and others.

N P C I L ' s w e b s i t e ([www.npcil.nic.in](http://www.npcil.nic.in)) continued providing updated information about the company worldwide. News article repository system, a source of information on nuclear power for employees of the company, was maintained. Setting up of a permanent exhibition on 'Hall of Nuclear Power' at the Nehru Science Centre, Mumbai" were also continued.

Nu-Power an international quarterly journal of NPCIL, was published regularly. Multimedia presentations/films were produced to disseminate information about the company and nuclear power. To show case DAE/NPCIL capabilities,

## Other Activities



*Dr. S.K. Jain, CMD, NPCIL (front row middle) and other NPCIL delegates are seen with the visitors of NPCIL's stall at Atom Expo Exhibition in Moscow, Russian Federation in May, 2009*

Programme (ESP)'. The programme focused on the scientific study of bio-diversity, particularly avifauna, within and around Exclusion Zones (EZs) of Indian nuclear power plants for the conservation and improvement of habitat.

To provide impetus to environment conservation initiatives, NPCIL signed MoU with Bombay Natural History Society (BNHS) and Surat. Nature Club to further ESP activities and development of a butterfly garden at KAPS. A study of wetlands and survey of birds in selected districts of Tamil Nadu was conducted by the NPCIL volunteers. The information collected on water birds and wetlands during the survey as a basis for contributing to their conservations was submitted to Asian Water bird Census (AWC) an Asia Region Programme to promote public participation to monitor the distribution and population of water birds and status of wetlands. A research note based on the observations during the survey was published.

The volunteers from Rajasthan Atomic Power Station (RAPS) were campaigning under the Environment Stewardship Programme, for the discontinuation of diclofenec drug which was responsible for the drastic decline of three Gyps vulture species in India. The study on the breeding population of Indian Skimmer at Narora site was further pursued. Check dams/anicuts to retain water for

8 exhibitions including 4 international exhibitions, were organized.

A book on 'Environment Stewardship Programme' of NPCIL was published. A new initiative of setting up butterfly garden at KAPS in collaboration with Nature club, Surat, was pursued. In this context 2500 plants comprising 60 species were planted. The butterfly garden was almost ready.

NPCIL participated in eight exhibitions at local, regional/national level and international forums showcasing Company's achievements and the benefits of nuclear power. Four international exhibitions were organized in Beijing, China

concurrent to IAEA ministerial conference, Russian federation in Atom Expo-2009, Kazakhstan in Indian Industry and in international conference 'Peaceful uses of Atomic Energy' organized by IAEA, DAE and INS.

At AMD, as a part of student awareness/contact programme in colleges and schools, lecture series, video shows, and exhibition on the exploration activities of the Directorate, question and answer sessions with students and faculty members were organized. Photo exhibition on the life and achievements of Dr.Homi J Bhabha was also organized.

NPCIL continued its initiatives in 'Environment Stewardship

## Other Activities

maintaining soil moisture at three different locations were constructed by Rawatbhata site. Waste water from Narora site was diverted towards the exclusion zone (EZ) wetland to expand its area and protect it from drying during the summer months. This year a huge population of water fowls (about 10,000) including many migratory species inhabited the wetland of EZ during the peak season. A detailed report of biodiversity in the EZ of Kudankulam Nuclear Power Project was prepared by the site with the help of outside experts.

As a part of student awareness/contact programme in colleges and schools, lecture series, video shows, and exhibition on the exploration activities of AMD, question and answer sessions with students and faculty members were organized. A photo exhibition on the life and achievements of Dr. Homi J Bhabha was organized at Hyderabad.

As a part of the scientific awareness programme, the

Institute of Physics continued to support a Science Education Programme of the Samanta Chandra Sekhar Amateur Astronomers' Association, Bhubaneswar in which several members of Institute and the National Institute of Science Education and Research (NISER) actively participated.

Under this programme, the members of the Association, along with the invited speakers visited a large numbers of villages of Orissa. Popular lectures were given to village students and other members of the community.

### SOCIAL WELFARE

NPCIL continued its Corporate Social Responsibility initiatives, essentially to support the community in an around its nuclear power plants, in three areas, Health, Education and Infrastructure development. The support in Health measures included organising regular medical check-ups and extending medical assistance in emergency

cases, blood donation camps, eye camps, providing drinking water etc.

The support in education comprised of providing of educational infrastructure development essentially the school building, laboratory equipment, furniture, teaching aids, such as computer and study materials to school etc. In addition to this, meritorious and needy children were adopted for their education at NPCIL sites. The company provided financial assistance to several institutions and events such as Blind Organisation of India, DAE Safety Meet, All India Association of Industries, etc.

### EMPLOYEES' WELFARE

#### Employees' Healthcare

The facility of medical care covered under the CHSS scheme continued to benefit the employees of DAE organizations, and their dependents, through



*Madras Atomic Power Station provided Tricycle to the Invalid*



*Multipurpose Hall constructed at Wail wada village, Mallapur, KGS-1&2*



## Other Activities

zonal dispensaries and hospital. Medical facilities were also extended to retired employees and their family members. New Version of Hospital Information System (HIS) was introduced for better patient management. This is an in-house developed intranet website for previous Hospital Circular System which gives in detailed overview of services and important information. All the zonal dispensaries are now connected to HIS.

During the spread of Swine flu (H1N1), a special isolation ward was created in Casualty Section of BARC hospital, for admission of suspected patients.

BARC hospital was chosen for treatment of Influenza (H1N1), suspected as well as positive patients. Daily statistical analysis report of Swine Flu, suspected as well as positive cases, and consumption of Tamiflu (Oseltamivir) medicine, to the Directorate of Health Services Maharashtra State, were sent.

### Employees' Children Education

The Atomic Energy Education Society (AEES), an autonomous institution, provides education to children of employees of DAE and its constituent organisations. At present, AEES administers 30 schools/junior colleges at 15 different locations all over the country, with total student strength of nearly 28,000.

AEES has achieved significant

results in its pursuit of excellence in academic as well as non-academic fields. Enrichment of the school libraries, computer aided education, improved sports facilities, in-service training programmes for teachers and enrichment programmes for students have helped in setting new benchmarks in excellence.

Several new initiatives like launching of key long-term projects such as Application of Science and Technology for Educational Reforms (ASTER), Simplified Programmes for Educational Excellence and Development (SPEED) and on-going programmes like the initiation of Adventure Sports, Projects Green Shield to spread awareness about the environment, and a project called "The Spirit of Gandhi" to spread the Gandhian philosophy, helped in widening the scope of education. Welfare measures aimed at students as well as the community around were also taken up.

As regards academic record, in the All India Secondary School Examination held in March 2009, the average pass percentage was 98.96%. In the Higher Secondary Examination, the average pass percentage was 90.50%.

The Talent Nurture Programme for bright students from the rural/tribal areas has been running at eleven centres. Under this programme, at present 1055 children are receiving free education and other facilities.

The Homi Bhabha Rolling Trophy was awarded to AECS, Manuguru for the best overall performance among schools and to the Atomic Energy Jr. College, Mumbai for the best overall performance among junior colleges for the year 2007-08.

The Dr. Vikram Sarabhai Rolling Trophy was awarded to AECS-2, Tarapur, for being the most progressive school of the AEES and to AECS-1, Tarapur for being the most progressive junior college of the AEES.

All India Junior Science and Mathematics Olympiad as well as the AEES Science and Social Science Exhibitions are organized every year to motivate and nurture the students.

### DAE SPORTS AND CULTURAL ACTIVITIES

The DAE Sports and Cultural Council looks after the promotion of sports and cultural activities among DAE employees and their families located at various units all over India. During the current year, it continued all its regular activities and introduced a few new initiatives towards achieving this objective.

The XXV DAE sports & Cultural Meet was scheduled to be organized for ten different sports and cultural events at ten units of DAE at various locations in the country.

During this silver jubilee event, around 1000 employees took part

## Other Activities



*Training on Rock Climbing at Children's Nature & Adventure Camp*

activities, “Healthy Living” programmes and regular yoga activities as well as camps were organized at different centers at various levels as well as for their family members. Yoga Magazines, for updating the latest techniques etc. in Yoga Science, were supplied to all the schools and different units of DAE. To further encourage Yoga and Fitness, DAE units were encouraged and financially supported to set up Fitness Centres for their employees and family members. DAE employees were nominated for short term conferences and workshop on applications of Yoga to healthy living at Kaivalyadham, Lonavala and Vivekanand Yoga Anusandhanana Samsthana, Bangalore.

Every year, the DAE S&CC organizes all India level painting competition for the school going children of DAE family. This year, the painting competition was held at AEES centre at Rawatbhatta.

In the Nature and adventure programme, DAE's annual all India trekking programme “Girisanchar-21” was organized with the approval of the Indian Mountaineering Federation, in the region of Chandoli National Park, Sangli, Maharashtra along the back-water of Warna Dam.

As a new initiative and in collaboration with the Nature and Adventure Circle, BARC Staff Club, a nature and adventure camp for children (8-13 years) of DAE employees was conducted at

in the final meets and more than 2000 employees working at the 37 DAE units all over India, participated in the selection trials. To conduct these final meets, many new playing facilities were added at various locations and existing facilities were upgraded, as part of developing infrastructure for Sports & Cultural activities.

The Council, in association with the AEES, conducted Annual Summer Sports Camps at various centers for promoting sporting spirit and encouraging sporting talent amongst school going children of the DAE family. About 1500 children participated in these camps where the talented children were selected for advanced coaching in individual sports. An

advanced coaching scheme instituted for talented children from the summer camps facilitates more than 150 children through a scholarship scheme in pursuing advanced training in various sports like badminton, table tennis, tennis, cricket etc. In addition, local tournaments in badminton, table tennis, tennis and a Mumbai District level table tennis tournament were organized. The amount of subsidy provided for children's coaching was increased for availing better coach and infrastructure. Over the years, the advanced coaching programme was instrumental in DAE children participating in state and national level competitions.

Under its Health and Fitness

## Other Activities

Raigad, Maharashtra during December, 2009. About 50 children of DAE employees participated and received conditioning training in rock climbing, nature awareness etc. In addition, the camp was designed to infuse a spirit of adventure and sense of leadership amongst these children.

In another new initiative during this year, a guided trek to the Himalayas was organized during September for 25 DAE Employees in Uttarkashi, Gangotri, Gomukh, Tapowan region.

As a part of infrastructural development and promotional activities, DAE S&CC also supported the establishment of various sports and cultural equipment and activities in many of the residential colonies of the Department. Being affiliated to various sports bodies at the national level, training and participation of DAE teams in All India National level tournaments

in Bridge, Table Tennis, Badminton and Ball Badminton were organized.

### AWARDS

Awards won by the Nuclear Power Stations of NPCIL during the report period :

#### TAPS-1&2

- ★ Suraksha Puraskar from National Safety Council of India (NSCI) for the year 2008.
- ★ National Safety Council (Maharashtra Chapter) awarded a plaque for factories work over one million man-hours under scheme-II longest accident free period for the year 2008.

#### TAPS-3&4

- ★ Integrated Management System Certification (IMS) from the Bureau Veritas, India, accredited by American National Accreditation Board

(ANAB). The Integrated Management System includes the ISO 9001:2008, ISO 14001:2004 and ISO 18001:2007 certification.

#### RAPS-1&2

- ★ Safety Innovation Award-2009 by the Institutions of Engineers New Delhi.
- ★ Prasansha Patra Safety Award-2008 from NSCI.

#### MAPS

- ★ AREB Industrial Safety Award for the year 2008.

#### NAPS

- ★ Shreshtha Suraksha Puraskar-2008 from NSCI.

#### KAPS

- ★ National Safety Award -2007 in Categories - I & II from DGFASLI.
- ★ Sarvashreshtha Suraksha Puruskar-2008 from NSCI
- ★ AERB “Annual Green Site Award (Category-B)” for the



*KAPS receiving "National Safety Awards" from Ministry of Labour and Employment, Government of India (Winner in Scheme-I & II)*



*KGS-1&2 receiving Unnatha Suraksha Puraskar from NSCI, Bangalore*



## Other Activities

year 2008.

### *KGS-1&2*

- ★ Shreshtha Suraksha Puraskar from NSCI for the year 2008.
- ★ Unnatha Suraksha Puraskar from Karnataka Chapter Safety Council, Bangalore for the year 2009.

### *KGS-3&4*

- ★ AREB Industrial safety award for the year 2008.

### *KKNPP*

- ★ Second Level 'Silver Safety Award' for the year 2008 in the category of construction Sector as Client from National Safety Council, Mumbai.
- ★ Fourth Level 'Prashansa Patra' Award for the year 2008 in the category of construction Sector as Client from National Safety Council, Mumbai.

### *HWP, Manuguru*

- ★ Prashansa Patra Award for the year 2008 by National Safety Council.
- ★ AERB Industrial Safety Award-2008,
- ★ Recommended for the certification of Occupational Health & Safety Management System as per IS-18001(2007) by M/s BIS after certification audit.

### *Heavy Water Plant, Kota*

- ★ Suraksha Puraskar for the year-2008 by National Safety Council of India.
- ★ ICC Award-2009 for Water Resource Management In Chemical Industry.

### *HWP, Thal*

- ★ National Energy Conservation Award 2008-09 (2nd prize)

### *Heavy Water Plant, Baroda*

- ★ The Gujarat Safety Council awarded a certificate of honour and a certificate of excellence for the calendar year 2008.

**IRE** received the following awards during the report period :

### *OSCOM*

- ★ Second runners up for “Best Practices In Environment, Safety and Health (EHS)” in the competition conducted by the CII (Confederation of Indian Industry) at the State level.

### *Manavalkurichi Unit*

- ★ National Safety Awards (Mines) for the year 2007 under the category “Lowest Injury Frequency Rate” by the Ministry of Labour and Environment, Government of India.
- ★ AERB's Green Site Award (Category-B).

**ECIL** bagged the following prestigious awards on 15th October 2009 :

- ★ MoU Excellence Awards for 2006-07 and 2007-08 in “Electronics & Communication Sector” from the Department of Public

Enterprises.

- ★ Scope Award for Excellence and Outstanding Contribution to the Public Sector Management 2007-08 in the Medium Public Sector Enterprise Category” from SCOPE

During the report period, the **Tata Memorial Centre (TMC)** was selected by Council for Fair Business Practices for receiving CFBP Jamnalal Bajaj Uchit Vyavahar Puraskar 2008 in the category of Professional Services Hospitals.

TMC's Department of Radiodiagnosis was recognized by the Medical Council of India as a teaching department for M.D. course (Radio diagnosis and DMRD courses).



# Chapter 11

## Implementation of Persons with Disabilities (Equal Opportunities, Protection of Rights & Full Participation) Act, 1995

The Department of Atomic Energy has a mandate to develop peaceful uses of nuclear energy in areas like power generation and basic research in frontier areas of science and technology. In view of the nature of activities carried out by the Scientific and Technical persons in various Research Centres, Public Sector Undertakings, Industrial Units and Aided Institutions of the Department, this Department is not in a position to implement the provisions of reservation of posts fully as required under the "Persons with Disabilities (Equal Opportunities, Protection of Rights and Full Participation) Act, 1995". Therefore, this Department has already sought exemption for the Units like Heavy Water Boards and Nuclear Power Corporation of India Ltd. From the provisions of the said Act. No specific scheme under plan projects for the benefit of persons with disabilities has been introduced in the Department. In spite of the constraints, all the Units/PSUs/Aided Institutions have attempted to identify posts, where persons with disabilities could be employed without impairing the activities or causing inconvenience.

The sanctioned strength and number of persons with disabilities in various posts in Group A, B, C & D against 3% vacancies to be reserved for them under Section 33 of the said Act is indicated in the pages that follow.



ANNUAL STATEMENT FOR THE YEAR 2009-10 SHOWING THE REPRESENTATION OF THE PERSONS WITH DISABILITIES IN THE DEPARTMENT OF ATOMIC ENERGY AND ITS UNITS

GROUP	NUMBER OF EMPLOYEES				DIRECT RECRUITMENT							PROMOTION							
	TOTAL	VH	HH	OH	NO. OF VACANCIES RESERVED			NO. OF APPOINTMENT MADE				NO. OF VACANCIES RESERVED			NO. OF APPOINTMENT MADE				
					VH	HH	OH	TOTAL	VH	HH	OH		VH	HH	OH	TOTAL	VH	HH	OH
1	2	3	4	5	6	7	8	9	10	11	12		13	14	15	16	17	18	19
GROUP A	6424	---	----	52	23	----	05	139	----	----	----		77	---	----	21	---	----	---
GROUP B	6933	02	04	91	59	02	02	58	--	---	---		39	---	----	180	----	01	01
GROUP C	9593	13	18	148	77	10	12	121	---	01	06		33	05	01	39	----	----	----
GROUP D	6424	---	----	52	23	----	05	139	----	----	----		77	---	----	21	---	----	----
TOTAL	29374	15	22	343	182	12	24	457	-----	01	06		226	05	01	261	---	01	01

Note: (i) VH stands for Visually Handicapped (Persons suffering from blindness or low vision)

(ii) HH stands for hearing handicapped (persons suffering from hearing impairment)

(iii) OH stands for Orthopadically Handicapped (Persons suffering from locomotor disability or cerebral palsy)

ANNUAL STATEMENT FOR THE YEAR 2009-10 SHOWING THE REPRESENTATION OF THE PERSONS WITH DISABILITIES IN THE PUBLIC SECTOR UNDERTAKINGS

GROUP	NUMBER OF EMPLOYEES						DIRECT RECRUITMENT						PROMOTION						
	NO. OF VACANCIES RESERVED						NO. OF VACANCIES RESERVED						NO. OF VACANCIES RESERVED						
	TOTAL	VH	HH	OH	VH	HH	OH	TOTAL	VH	HH	OH	TOTAL	VH	HH	OH	TOTAL	VH	HH	OH
1	2	3	4	5	6	7	8	9	10	11	12	13	14	15	16	17	18	19	
GROUP A	2646	04	03	71	49	02	02	21	---	---	---	---	---	---	09	---	---	---	---
GROUP B	1547	03	03	30	02	01	04	106	03	---	07	---	---	---	05	---	---	---	---
GROUP C	3474	05	03	120	02	01	02	171	---	01	03	---	---	---	99	---	---	---	---
GROUP D	2646	04	03	71	49	02	02	21	---	---	---	---	---	---	09	---	---	---	---
TOTAL	10313	16	12	292	102	06	10	319	03	01	10	---	---	---	122	---	---	---	---

ANNUAL STATEMENT FOR THE YEAR 2009-10 SHOWING THE REPRESENTATION OF THE PERSONS WITH DISABILITIES IN THE AIDED INSTITUTIONS.

GROUP	NUMBER OF EMPLOYEES						DIRECT RECRUITMENT						PROMOTION								
	VH		HH		OH		RESERVED		NO. OF VACANCIES		NO. OF APPOINTMENT MADE		RESERVED		NO. OF VACANCIES		NO. OF APPOINTMENT MADE				
	TOTAL		TOTAL		TOTAL		VH	HH	OH	TOTAL	VH	HH	OH	VH	HH	OH	TOTAL	VH	HH	OH	
1	2	3	4	5	6	7	8	9	10	11	12	13	14	15	16	17	18	19			
GROUP A	825	02	01	03	---	06	01	38	---	---	---	---	---	---	---	---	---	---	---	---	---
GROUP B	1391	01	01	05	---	03	03	16	---	---	01	---	---	---	---	---	---	---	---	---	---
GROUP C	990	01	01	12	01	02	01	06	---	---	---	---	---	---	---	---	---	---	---	---	---
GROUP D	825	02	01	03	---	06	01	38	---	---	---	---	---	---	---	---	---	---	---	---	---
TOTAL	4031	06	04	23	01	17	06	98	---	---	01	---	---	---	---	---	---	---	---	---	---



Chapter : 12

## Citizen's Charter



# Citizen's Charter

## I) OUR VISION

The vision of the Department of Atomic Energy is to empower India through technology, creation of more wealth and providing better quality of life to its citizen. This is to be achieved by making India energy independent, contributing to provision of sufficient, safe and nutritious food and better health care to our people through development and deployment of nuclear and radiation technologies and their applications.

## II) OUR CLIENTS

- User Ministries/Departments of Central Govt. and State Govt. dealing with energy, agriculture, food, health, education, oil and petroleum, industry, science and technology etc.
- Quasi Govt. Organisations, NGOs, industrial organizations, educational institutes.
- Electricity Boards, Hospitals, Research / Medical / Educational / Academic Institutions, agriculturists etc.

## III) OUR ACTIVITIES

The Department is engaged in the design, construction and operation of nuclear power / research reactors and the supporting nuclear fuel cycle technologies covering exploration, mining and processing of nuclear minerals, production of heavy water, nuclear fuel fabrication, fuel reprocessing and nuclear waste management. It is also developing advanced technologies which contribute to the national prosperity. The human resource developed and technical services being rendered by the Department have been greatly helping the Indian industry.

The Department is also developing better crop varieties, techniques for control/eradication of insects thus protecting the crops, radiation based post harvest technologies, radiation based techniques for diagnosis and therapy of disease particularly cancer, technologies for safe drinking water, better environment and robust industry.

## IV) MANDATE

The mandate of the Department, on which its programmes are based, covers :

- Increasing share of nuclear power through deployment of indigenous and other proven technologies, along with development of fast breeder reactors and thorium reactors with associated fuel cycle facilities ;
- Building and operation of research reactors for production of radioisotopes and carrying out radiation technology applications in the field of medicine, agriculture and industry;
- Developing advanced technologies such as accelerators, lasers, supercomputers, advanced materials and instrumentation, and encouraging transfer of technology to industry;
- Support to basic research in nuclear energy and related frontier areas of science; interaction with universities and academic institutions; Support to research and development projects having a bearing in DAE's programmes, and international cooperation in related advanced areas of research, and
- Contribution to national security.

# Citizen's Charter

## V) DAE PROGRAMMES RELATING TO THE NATIONAL COMMON MINIMUM PROGRAMME

### HIGH POTENTIAL DOMAINS FOR DEVELOPMENTAL APPLICATIONS

#### **AGRICULTURE**

Enhanced production of oilseeds and pulses

#### **EDUCATION, HEALTH**

- Homi Bhabha National Institute (HBNI)
- National Initiative on Undergraduate Science (NIUS)
- Countrywide Services in Cancer through Telemedicine

#### **FOOD & NUTRITION SECURITY**

Radiation Processing of Food & Agro Products

#### **WATER RESOURCES**

Desalination in water scarcity areas along the sea coast

#### **ENERGY SECURITY**

Electricity supply in near and long term ensuring long term sustainable development.  
Rule of Nuclear Power as Primary Energy Source in the years to come.

## VI) WHOM TO CONTACT

### **I. Public Grievance and complaints**

Shri A.P. Joshi,  
Additional Secretary, Public Grievances Officer & Chief Vigilance Officer, Department of Atomic Energy,  
Anushakti Bhavan, C.S.M. Marg, Mumbai-400 001.

Tel. No. 022-22029328

Email I.D. : as@dae.gov.in

apj@dae.gov.in

### **II. Public Relations**

Shri S.K. Malhotra,  
Head, Public Awareness Division, Department of Atomic Energy,  
Anushakti Bhavan, C.S.M. Marg, Mumbai-400 001.

Tel.No. 022-22823144

Email I.D. : skm@dae.gov.in



# Citizen's Charter

**Government of India  
Department of Atomic Energy  
Anushakti Bhavan, C.S.M. Marg,  
Mumbai - 400 001**

## **NOTICE**

WE, THE PUBLIC SERVANTS OF INDIA DO HEREBY SOLEMNLY PLEDGE THAT WE SHALL CONTINUOUSLY STRIVE TO BRING ABOUT INTEGRITY AND TRANSPARENCY IN ALL SPHERES OF OUR ACTIVITIES. WE ALSO PLEDGE THAT WE SHALL WORK UNSTINTINGLY FOR ERADICATION OF CORRUPTION IN ALL SPHERES OF LIFE. WE SHALL REMAIN VIGILANT AND WORK TOWARDS THE GROWTH AND REPUTATION OF OUR ORGANISATION. THROUGH OUR COLLECTIVE EFFORTS, WE SHALL BRING PRIDE TO OUR ORGANISATIONS AND PROVIDE VALUE BASED SERVICE TO OUR COUNTRYMEN. WE SHALL DO OUR DUTY CONSCIENTIOUSLY AND ACT WITHOUT FEAR OR FAVOUR.

THIS OFFICE IS THUS COMMITTED TO MAINTAINING THE HIGHEST LEVEL OF ETHICS IN ITS WORKING TOWARDS ACHIEVING THE ABOVE OBJECTIVE, ALL ARE REQUESTED :

- \* NOT TO PAY BRIBE
- \* IF ANYBODY IN THIS DEPARTMENT OR ITS OFFICES ASKS FOR BRIBE OR
- \* IF YOU HAVE ANY INFORMATION ON CORRUPTION OR IF YOU ARE A VICTIM OF CORRUPTION IN ANY OF OUR OFFICES.

### **YOU MAY COMPLAIN TO :-**

Shri A.P. Joshi,  
Additional Secretary,  
Public Grievances Officer & Chief Vigilance Officer,  
Department of Atomic Energy,  
Anushakti Bhavan, C.S.M. Marg,  
Mumbai-400 001.

### **YOU MAY ALSO COMPLAIN TO THE :-**

CENTRAL VIGILANCE COMMISSION,  
SATARKTA BHAWAN, BLOCK 'A',  
GPO COMPLEX, INA,  
NEW DELHI 110 023.

# Annexes





# Annex-I

## The Organisation

### THE ORGANISATION

The Department of Atomic Energy (DAE), that came into being on August 3, 1954, has been engaged in the development of nuclear power technology, applications of radiation technologies in the fields of agriculture, medicine, industry, and basic research.

As integrated group of organizations, the Department comprises five Research Centres, three Industrial Organisations, five Public Sector Undertakings and three Service Organisations. It has under its aegis two Boards for promoting and funding extra-mural research in nuclear and allied fields, and mathematics, and a national institute (deemed university).

It also supports eight institutes of international repute engaged in research in basic sciences, astronomy, astrophysics, cancer research and education, etc., and a society that provides educational facilities to the children of DAE employees. The organizational structure of the Department is given below.

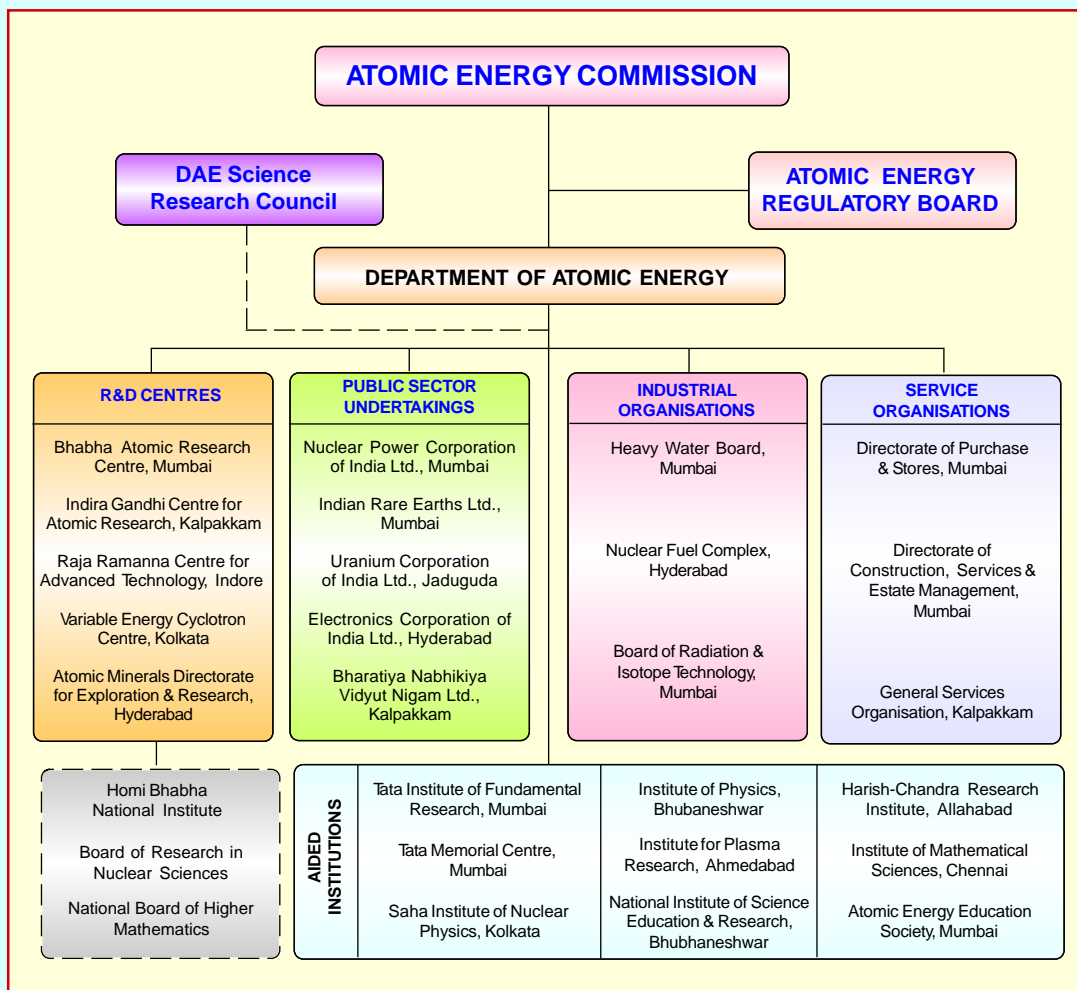

# Major Programmes and Sub-Programmes

MP 1		MP 2		MP 3		MP 4		MP 5		MP 6		MP 7	
1.01	PHWR	2.01	Fast Reactors	3.01	Advanced Heavy Water Reactor	4.01	Research Reactors	5.01	Mathematics & Computational Sciences	6.01	Human Resource Development	7.01	Infrastructure
1.02	LWR	2.02	Materials	3.02	Thorium Fuel Cycle	4.02	Isotope Processing	5.02	Physics	6.02	Sponsored Research	7.02	Housing
1.03	Front End Fuel Cycle	2.03	FBR-Front End Fuel Cycle	3.03	Other Thorium Reactor Systems	4.03	Agriculture	5.03	Chemistry	6.03	Prospective Research Fund		
1.04	Back End Fuel Cycle	2.04	FBR-Back End Fuel Cycle	3.04	Accelerator Driven Sub-critical Systems	4.04	Food Processing	5.04	Biology	6.04	Homi Bhabha Centre for Science Education		
1.05	Health, Safety & Environment	2.05	Repair and Inspection Technologies	3.05	Materials	4.05	Health	5.05	Cancer	6.05	Information Technology Application Development		
1.06	PHWR	2.06	FBR-Health, Safety & Environment	3.06	Hydrogen Energy	4.06	Water	5.06	Synchrotrons & their Utilisation				
				3.07	Fusion Reactor	4.07	Industrial Applications	5.07	Cyclotrons & their Utilisation				
						4.08	Accelerators	5.08	Fusion & Other Plasma Technologies				
						4.09	Lasers	5.09	Material Science				
						4.10	Special Materials	5.10	Interdisciplinary Areas				
						4.11	Advanced Technologies	5.11	International Research Collaborations				
						4.12	Special Programmes						

## MAJOR PROGRAMMES

- MP-1** : Nuclear Power Programme-Stage-1  
**MP-2** : Nuclear Power Programme-Stage-2  
**MP-3** : Nuclear Power Programme-Stage-3 and beyond  
**MP-4** : Advanced Technologies and Radiation Technologies and their Applications  
**4A** : Advanced Technologies and their Applications (Includes sub-programmes 4.01, 4.08 to 4.12)  
**4B** : Radiation Technologies and their Applications (Includes sub programme 4.02 to 4.07)  
**MP-5** : Basic Research  
**MP-6** : Research Education Linkages  
**MP-7** : Infrastructure & Housing

# Atomic Energy Establishments in India



Research & Development Organisations
  Public Sector Undertakings
  Industrial Facilities
  Grant-in-aid Organisations
  Service Organisations



## Annex-II

# Reply to Audit Observation

**REPORT OF THE COMPTROLLER AND AUDITOR GENERAL OF INDIA FOR THE YEAR ENDED MARCH 2008, UNION GOVERNMENT (COMPLIANCE AUDIT) NO. CA16 OF 2008-09, TABLED IN THE PARLIAMENT ON 10 JULY 2009**

### **Non-achievement of objectives by Board of Radiation and Isotope Technology**

Failure of Board of Radiation and Isotope Technology (BRIT), under Department of Atomic energy, to ensure timely execution of projects, both in the Ninth and Tenth Plan resulted not only in time and cost overruns but also in delayed / non-achievement of socio-economic objectives relating to application of radioisotopes and radiation in areas of healthcare, industry, agriculture, research etc. Monitoring of projects was lax which also contributed to slippages in milestones set out for projects. BRIT had still not taken steps to attain commercial viability which was one of the objectives of BRIT when it was set up in 1988.

### **Non-establishment of world class gamma-ray observatory**

Despite an expenditure of Rs. 16.18 crore on setting up of TACTIC and MYSTIQUE telescopes by Department of Atomic Energy, the objective of establishing world class gamma-ray observatory with state-of-art technology for gamma-ray astrophysics experiments could not be achieved. While TACTIC and MYSTIQUE telescopes were established at Mount Abu, Rajasthan with significant cost and time overruns. BEST telescope was not sanctioned and the MACE telescope was shifted to Hanle, Ladakh. Thus, the objective of establishing the four telescopes at a single location could not be fully achieved. In addition, the TACTIC and MYSTIQUE telescopes were under-utilised and commercial spin-offs expected from the project also did not accrue.

### **Loss of Rs. 1.84 crore due to non-termination/renegotiation of an agreement**

Failure of Department of Atomic Energy to negotiate/terminate the lease agreement with Indian Oil Corporation Ltd. under the relevant clause, caused revenue loss of Rs. 1.84 crore.

### **Implementation of liberalized scheme for doctors in Tata Memorial Centre without approval of Ministry of Finance**

Tata Memorial Centre (TMC) an autonomous body under Department of Atomic Energy, was receiving grants-in-aid constituting more than 50 per cent of its expenditure from the Government. It implemented a Private Practice Scheme under which doctors were allowed to receive a share of 40 to 45 per cent of hospital income in lieu of non-practicing allowance. This scheme was implemented without the approval of Cabinet/Ministry of Finance or concurrence of other departments. This resulted in payment of Rs. 27.22 crore to the doctors at TMC without requisite approvals. No such lucrative scheme is being implemented in other autonomous bodies/centers of excellence such as All India Institute of Medical Sciences under control of Ministry of Health and Family Welfare.

### **Rejoinder**

*“The Private Practice Scheme has been in existence even before the TMC was taken over by the Department, and Ministry of Finance vide their O.M. No. 10/DS(E-II/CA)/09 dated 18th March 2009 have conveyed their no objection for continuing the scheme. Therefore, the observation of audit that the scheme does not have the approval of Ministry of Finance is not based on facts.”*

# Reply to Audit Observation

## **Excess expenditure on security**

Failure of Bhabha Atomic Research Centre to share the expenditure for security on the basis of actual deployment of Central Industrial Security Force personnel at each facility led to excess expenditure of Rs. 3.38 crore.

## **Avoidable expenditure on power consumption**

Failure of Variable Energy Cyclotron Centre, Kolkatta to realistically assess the demand for electricity periodically resulted in an avoidable expenditure of Rs. 59.75 lakh towards shortfall in consumption against the contracted demand during July 2004 to December 2007.

## Annex-III

# Representation of SCs, STs And OBCs

ANNUAL STATEMENT FOR THE YEAR 2009-10 SHOWING THE REPRESENTATION OF SCs, STs AND OBCs IN THE DEPARTMENT OF ATOMIC ENERGY AND ITS UNITS

GROUP	NUMBER OF EMPLOYEES						NUMBER OF APPOINTMENT MADE DURING THE CALENDAR YEAR														
	BY DIRECT RECRUITMENT			BY PROMOTION			BY OTHER METHOD			BY DIRECT RECRUITMENT			BY PROMOTION			BY OTHER METHOD					
	TOTAL	SCs	STs	OBCs	TOTAL	SCs	STs	OBCs	TOTAL	SCs	STs	OBCs	TOTAL	SCs	STs	OBCs	TOTAL	SCs	STs	OBCs	
1	2	3	4	5	6	7	8	9	10	11	12	13	14	15							
GROUP A	8797	3599	4100	534	239	11	04	29	258	23	07	13	01	---							
GROUP B	9760	1723	452	947	145	15	13	68	390	62	11	19	02	02							
GROUP C	12323	2646	1099	1955	356	76	29	136	255	65	16	06	02	01							
GROUP D (EXCLUDING SAFAI KARAMCHAR IS)	1268	234	294	184	07	02	02	03	78	15	36	---	---	---							
GROUP D (SAFAI KARAMCHAR IS)	214	113	19	31	---	---	---	---	04	01	04	---	---	---							
TOTAL	32362	8315	5964	3651	747	104	48	236	985	166	74	38	05	03							



ANNUAL STATEMENT FOR THE YEAR 2009-10 SHOWING THE REPRESENTATION OF SCs, STs AND OBCs IN THE PUBLIC SECTOR UNDERTAKINGS

GROUP	NUMBER OF EMPLOYEES						NUMBER OF APPOINTMENT MADE DURING THE CALENDAR YEAR												
	BY DIRECT RECRUITMENT			BY PROMOTION			BY OTHER METHOD			BY DIRECT RECRUITMENT			BY PROMOTION			BY OTHER METHOD			
	TOTAL	SCs	STs	OBCs	TOTAL	SCs	STs	OBCs	TOTAL	SCs	STs	OBCs	TOTAL	SCs	STs	OBCs	TOTAL	SCs	STs
1	2	3	4	5	6	7	8	9	10	11	12	13	14	15					
GROUP A	6473	594	130	472	92	10	04	19	511	48	07	16	02	--					
GROUP B	5096	814	237	782	118	30	06	42	435	74	16	--	---	--					
GROUP C	8417	1418	1038	1818	361	82	51	123	647	150	55	---	---	---					
GROUP D (EXCLUDING SAFAI KARAMCHARIS)	3595	496	1217	666	27	05	09	06	20	08	01	---	---	--					
GROUP D (SAFAI KARAMCHARIS)	196	113	01	22	---	---	---	---	04	02	---	---	---	---					
TOTAL	23777	3435	2623	3760	598	127	70	190	1617	282	79	16	02	---					

ANNUAL STATEMENT FOR THE YEAR 2009-10 SHOWING THE REPRESENTATION OF SCs, STs AND OBCs IN THE AIDED INSTITUTIONS

GROUP	NUMBER OF EMPLOYEES					NUMBER OF APPOINTMENT MADE DURING THE CALENDAR YEAR														
						BY DIRECT RECRUITMENT					BY PROMOTION					BY OTHER METHOD				
	TOTAL	SCs	STs	OBCs		TOTAL	SCs	STs	OBCs		TOTAL	SCs	STs		TOTAL	SCs	STs			
1		3	4	5		6	7	8	9	10	11	12		13	14	15				
GROUP A	895	28	04	41		50	06	01	07	02										
GROUP B	2723	339	71	320		85	03	02	22	02										
GROUP C	1327	270	71	317		16	03	02	03	06	03									
GROUP D (EXCLUDING SAFAI KARAMCHARIS)	1031	199	38	70		03			01											
GROUP D (SAFAI KARAMCHARIS)	224	206	03																	
TOTAL	6200	1042	187	748		154	12	05	33	10	03									

# Abbreviations

ADS	Accelerator Driven Sub-critical System	MeV	Million Electron Volt
AES	Atomic Emission Spectrometer	MIBG	Meta Iodo-Benzyl Guanidine
AGRS	Air-borne Gamma-Ray Spectrometry	MoU	Memorandum of Understanding
AGSS	Aerial Gamma Spectrometric System	MOX	Mixed Oxide Fuel
ALARA	As Low As Reasonably Achievable	MSF-RO	Multi-Stage Flash Reverse Osmosis
CCCM	Centre for Compositional Characterisation of Materials	MWD/Te	Mega watt day per tonne
CCRM	Coolant Channel Replacement Machine	MWe	Mega Watt (electrical)
CERN	Organisation Européenne pour la Recherche Nucléaire	MWt	Mega Watt (thermal)
CHTR	Compact High Temperature Reactor	NDT	Non-Destructive Technique
CORAL	Compact Reprocessing facility for Advanced fuels in Lead cells	PCS	Process Control System
CWMF	Central Waste Management Facility	PHWR	Pressurised Heavy Water Reactor
DFRP	Demonstration Fast Reactor Reprocessing Plant	PREFRE	Power Reactor Fuel Reprocessing Plant
DSRDM	Diverse Safety Rod Drive Mechanism	PDSC	Project Design & Safety Committee
ECCS	Emergency Core Cooling System	QC/QA	Quality Control / Quality Assurance
ECR	Electron Cyclotron Resonance	QGP	Quark Gluon Plasma
ECRH	Electron Cyclotron Resonance Heating	QMS	Quadrupole Mass Spectrometer
EMF	Electro-motive force	R&M	Renovation & Maintenance
ERDS	Emergency Response Data System	RAPS/P	Rajasthan Atomic Power Station / Project
ESL	Environmental Survey Laboratory	REE	Rare Earth Elements
FBTR	Fast Breeder Test Reactor	RFQ	Radio Frequency Quadrupole
FDG	Fluoro deoxy glucose	RFID	Radio Frequency Identification
FFLM	Failed Fuel Location Module	RIA	Radioimmuno-assay
FRFCF	Fast Reactor Fuel Cycle Facility	RIB	Radioactive Ion Beam
HPU	Health Physics Unit	RIMS	Resonance Ionisation Mass Spectroscopy
HWP	Heavy Water Plant	RIP	Repository for Immobilised Waste Product
IAEA	International Atomic Energy Agency	RMC	Radiation Medicine Centre
ICP-MS	Inductively Coupled Plasma Mass Spectrometer	RO	Reverse Osmosis
ICRH	Ion Cyclotron Resonance Heating	RRMC	Regional Radiation Medicine Centre
ICRP	International Commission on Radiological Protection	RRS	Reactor Regulating System
IERMON	Indian Environmental Radiation Monitoring Network	SCADA	Supervision Control & Data Acquisition System
IPIG	Instrumented Pipe-line Inspection Gauge	SECC	Site Emergency Control Centre
IRMA	Immunoradiometric Assay	SODAR	Sound Detection and Ranging
ISI	Inservice Inspection	SQUID	Super-conduction Quantum Interference Device
ITER	International Thermo-nuclear Experimental Reactor	SRS	Synchrotron Radiation Source
KARP	Kalpakkam Fuel Reprocessing Plant	SSMS	Spark Source Mass Spectrometry
keV	Kilo Electron Volt	TAPS	Tarapur Atomic Power Station
kV	Kilo Volt	TBP	Tributyl Phosphate
LBS	Laser Blow-off System	TDEM	Time Domain Electromagnetic
LCTR	Large Component Test Rig	Th,Pu	Thorium, Plutonium
LHC	Large Hadron Collider	TLD	Thermo Luminescence Detector
LINAC	Linear Accelerator	tpd	Tonnes Per Day
LTVE	Low Temperature Vacuum Evaporation	U/Th-Mo-O	Uranium/Thorium-Molybdenum-Oxygen
mCi	Million Curies	UHF	Ultra High Frequency
		U-Zr-O	Uranium Zirconium Oxygen
		VSAT	Very Small Aperature Terminal
		WDXRF	Wave Dispersion X-Ray Fluorescence
		XRF	X-ray Radio Frequency



Edited and Published by S. K. Malhotra, Head, Public Awareness Division, DAE  
Digital Design by Digital Pundits, Thane.