

i-PIX

User Manual

BB4

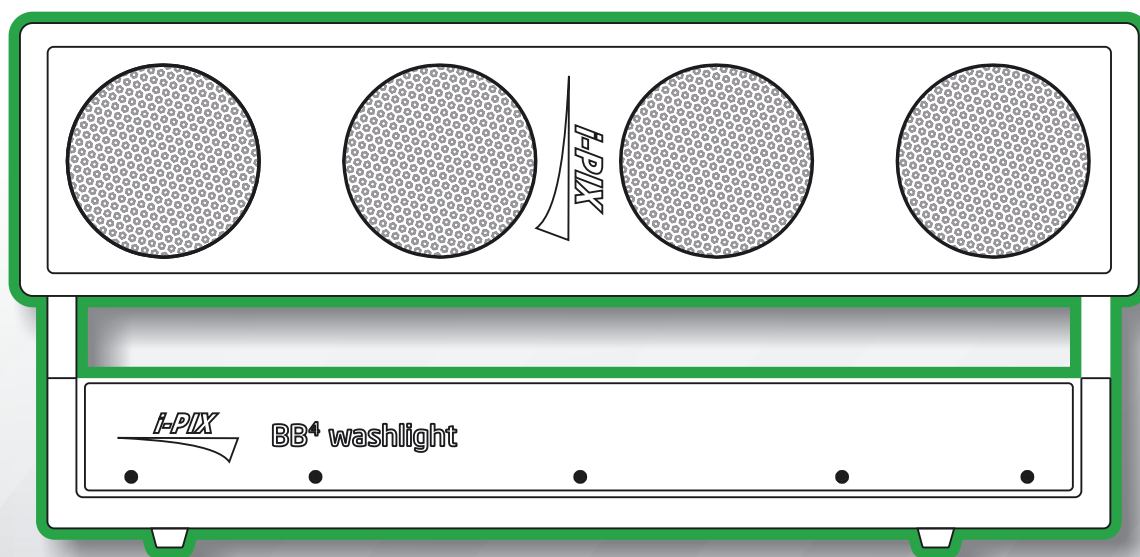

contents

INTRO, RIGGING, SET UP & MODES

SAFETY FIRST	page 3
THE BB4	page 5
RIGGING	page 6
SET UP	page 7
MODES	page 8
MODES A GRAPHICAL OVERVIEW	page 15

OPERATING INSTRUCTIONS

STAND ALONE FUNCTIONS	page 16
STORING A DMX INPUT AS A MEMORY	page 16
CREATING A MEMORY	page 17
RECALLING A MEMORY	page 19
CREATING A CHASE	page 21

THE TECHNICAL STUFF

CELL ORIENTATION	page 23
TECHNICAL SPECIFICATIONS	page 24
UNIT DIMENSIONS DRAWING	page 26
TROUBLE SHOOTING	page 27
QUICK RESET	page 29

APPENDICES

APPENDIX 1	ROHS COMPLIANCE AND WEE DIRECTIVE INSTRUCTIONS	page 30
APPENDIX 2	SERVICE CONTACT DETAILS	page 31

SAFETY FIRST



WARNING!
Read the safety precautions in this section before installing, powering, operating or servicing the BB4

The following symbols are used to identify important safety information in this manual:



Warning!
Safety hazard. Risk of severe injury or death



Warning!
LED light emission. Risk of eye injury



Warning!
Hazardous voltage. Risk of lethal or severe electric shock



Warning!
Fire hazard

! Read this manual before installing, powering or servicing the fixture, follow the safety precautions listed below and observe all warnings in this manual. If you have questions about how to operate the fixture safely, please contact I-Pix.



Warning! Class 2M LED product. Do not look into the beam from a distance of less than 40 cm (16 inches). Do not stare into the beam for extended periods at a short distance. Do not view the beam directly with optical instruments.



This product is for professional use only. It is not for household use. This product presents risks of severe injury or death due to fire hazards, electric shock and falls.



PROTECTION FROM ELECTRIC SHOCK

Shut down power to the entire installation at the building's main power distribution board and lock out power (by removing the fuse for example) before carrying out any installation or maintenance work.

Disconnect the fixture from AC power before removing or installing any cover or part and when not in use.

Disconnect the fixture from AC power before removing or changing the fuse.

Always ground (earth) the fixture electrically.

Use only a source of AC power that complies with local building and electrical codes and has both overload and ground-fault (earth-fault) protection.

Connect this fixture to AC power either using the supplied power cable or via 3- conductor cable that is rated minimum 20 amp, hard usage. Suitable cable types include ST, SJT, STW, SEO, SEOW and STO.

The voltage and frequency at the power outlet are the same as the voltage and frequency applied to the power inlet. Only connect devices to the power outlet that accept this voltage & frequency.

Before using the fixture, check that all power distribution equipment and cables are in perfect condition and rated for the current requirements of all connected devices.

Do not use the fixture if the power cable or power plug are in any way damaged, defective or wet, or if they show signs of overheating.



PROTECTION FROM FIRE

Do not attempt to bypass thermostatic switches or fuses. Replace defective fuses with ones of the specified type and rating only.

Provide a minimum clearance of 0.1 m (4 in.) around fans and air vents.

Do not modify the fixture

Apart from I-PIX accessories do not stick filters, masks or other materials directly onto the light.



PROTECTION FROM INJURY

Do not hang fixtures from each other. Use two OMEGA clamps per fixture or I-PIX SINGLE or DOUBLE YOLKS when suspending.

When suspending the fixture, ensure that the structure and all hardware used can hold at least 10 times the weight of all devices suspended from them.

Use two secondary attachments (such as a safety cable) to secure each fixture. Secondary attachments must be able to hold at least 10 times the weight of all devices suspended from them and must be installed as described in this manual.

Check that all external covers and rigging hardware are securely fastened.

Block access below the work area and work from a stable platform whenever installing, servicing or moving the fixture.



The LED emission presents a hazard to eyesight at a distance of 4 - 40 cm (1.6 -16 inches) when the eye is exposed to the beam for longer than 0.25 seconds.

Do not look at LEDs from a distance of less than 40 cm (1 ft. 4 in.) without suitable protective eye wear.

Do not look at LEDs with magnifiers or similar optical instruments that may concentrate the light output.

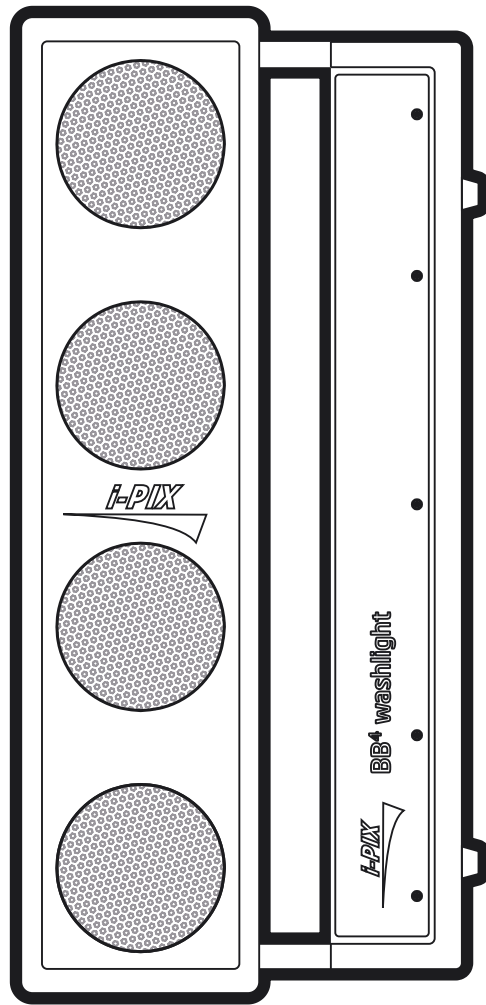

BB 4 Washlight

The BB 4 washlight provides the user with an energy saving high power light. Four powerful light sources gives the feel and look of a modern light fixture. LED in origin, the appearance from the four blended sources shows no visible appearance of existing led technology yet has the performance we have all come to understand from this novel form of light.

The BB 4 washlight, is equipped with four custom Light Engines from Lamina. It's one of the highest power point source led light available. It is the homogenized source of the three saturate colours that makes our colour mixing so good.

The performance of these light engines to i-pix's exacting colour specifications gives a tighter tolerance and improved colour performance, which makes tungsten lighting performance from the BB 4 possible. Daylight temperatures can also be found with ease and finally a fixture that does not need a nudge from amber to compensate. The whites are believable and full of low power energy, which makes one wonder if the source is really an led engine.

The BB 4 has a super smooth control with 16 bit resolution, enhancing the feel of the fixture when wishing to emulate the tungsten performance you would expect from pre existing fixtures. Different operating modes ensure ease of use. With consumption of 120 watts, the fixture draws half and amp on full @ 240 volts.

Rigging a BB4 horizontally

To rig a BB4 horizontally use the OMEGA brackets supplied with the lamp.

These would have your clamp of choice bolted on to them.

The OMEGA brackets can be attached to each end & the middle of the lamp using the camlocs.

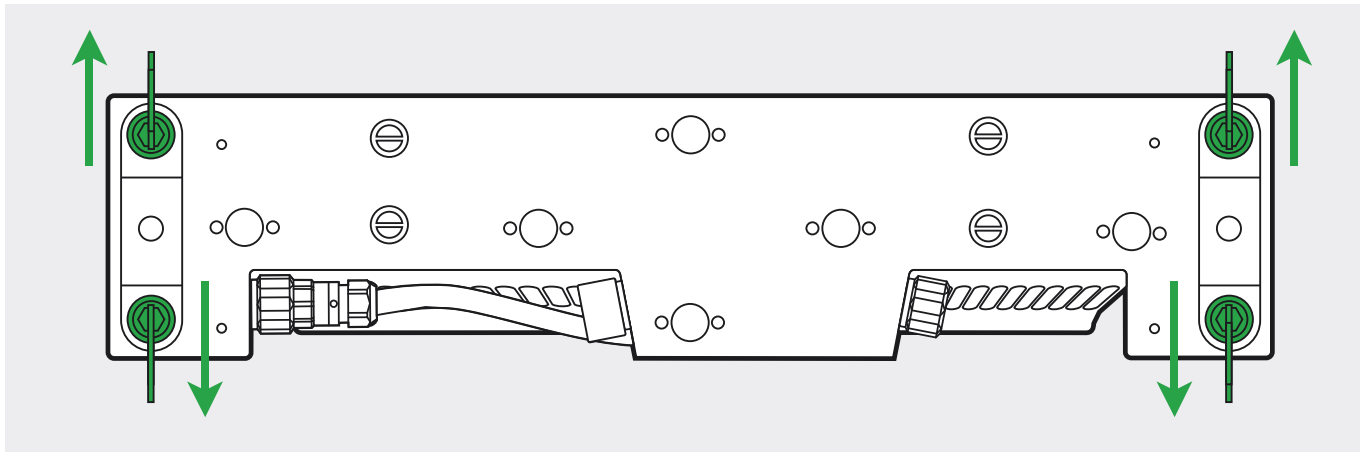

First place the camloc pins in the receptacles with the levers facing out then to secure the brackets give the levers a quarter turn clock wise.

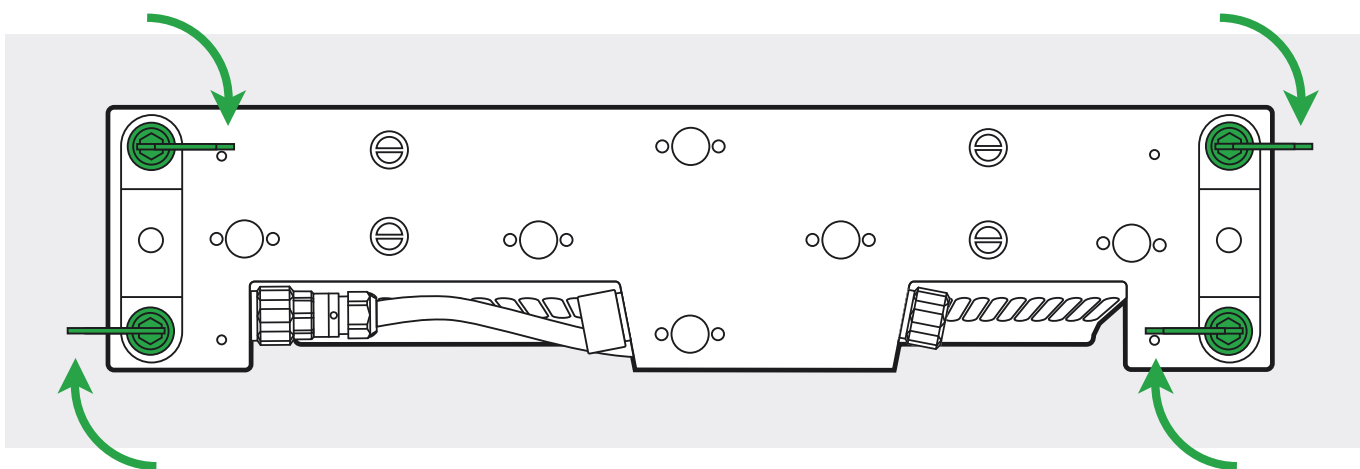

Make absolutely sure all four attachment points are secure BEFORE rigging the light ALWAYS secure the lamp to the truss, pipe e.t.c. with two safety bonds. One attached to the lamp through the safety point shown in fig 1 the other attached to the yolk through the safety point shown in fig 2 NEVER through or to the brackets.

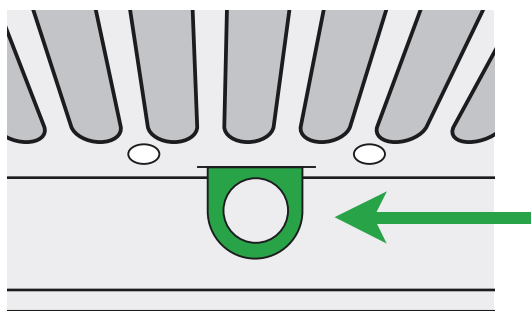

fig 1

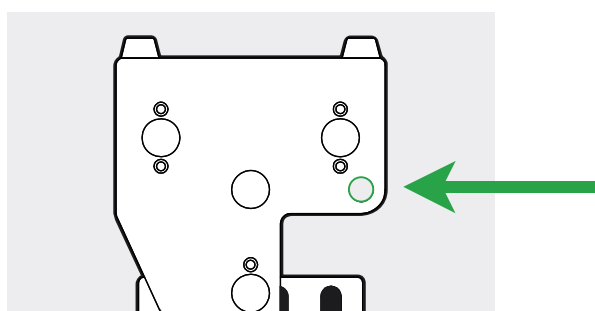

fig 2

Rigging a BB4 vertically

To rig a BB4 vertically use the SINGLE or DOUBLE YOLK hanging brackets. The brackets can be supplied as accessories for the lamp. You would obviously have your clamp of choice bolted on to them. The YOLK brackets can be attached to the top, middle or the lamp using the camlocs.

First place the camloc pins in the receptacles with the levers facing out the correct way.
Then to secure the brackets turn the levers a quarter turn clock wise.

WRONG

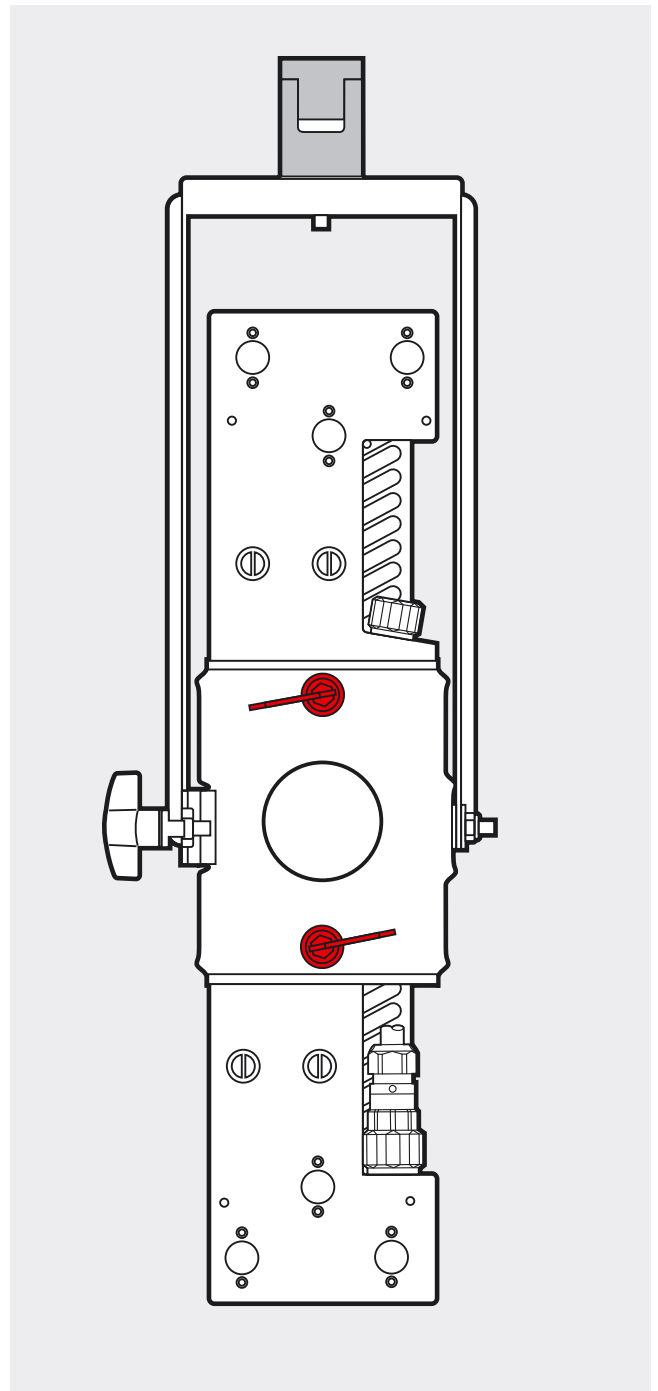
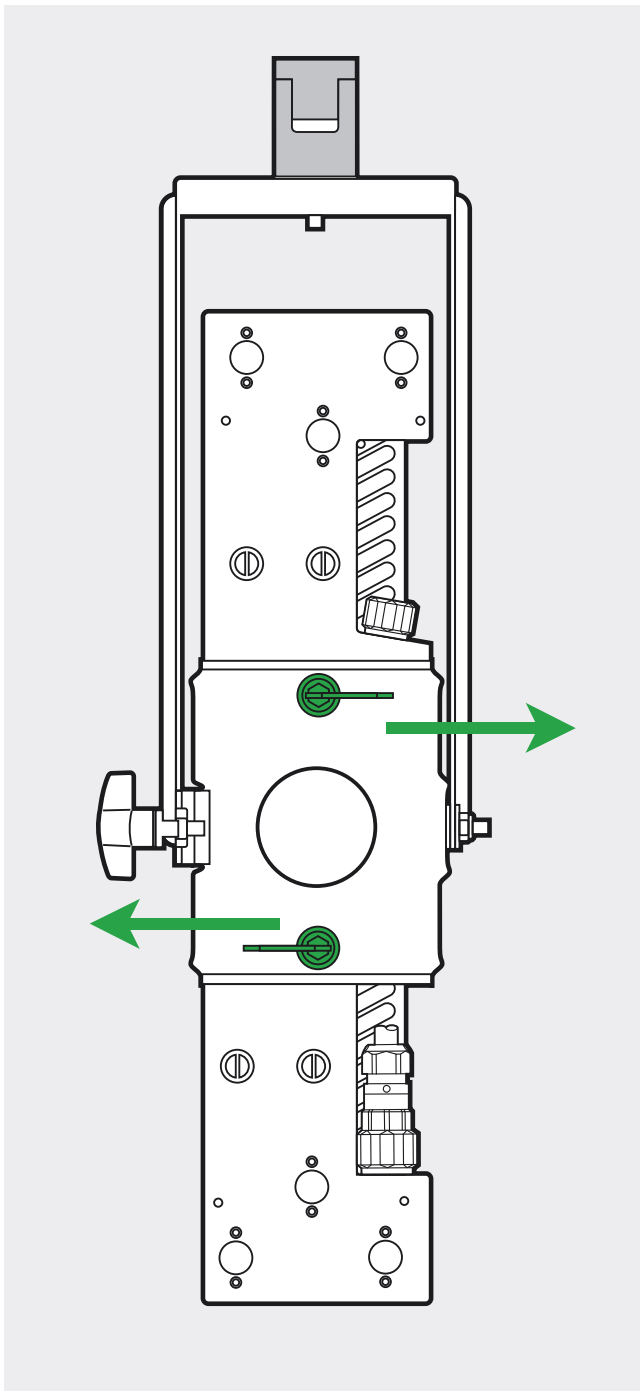

So after a quarter clockwise both levers should face each other in the centre.

WRONG

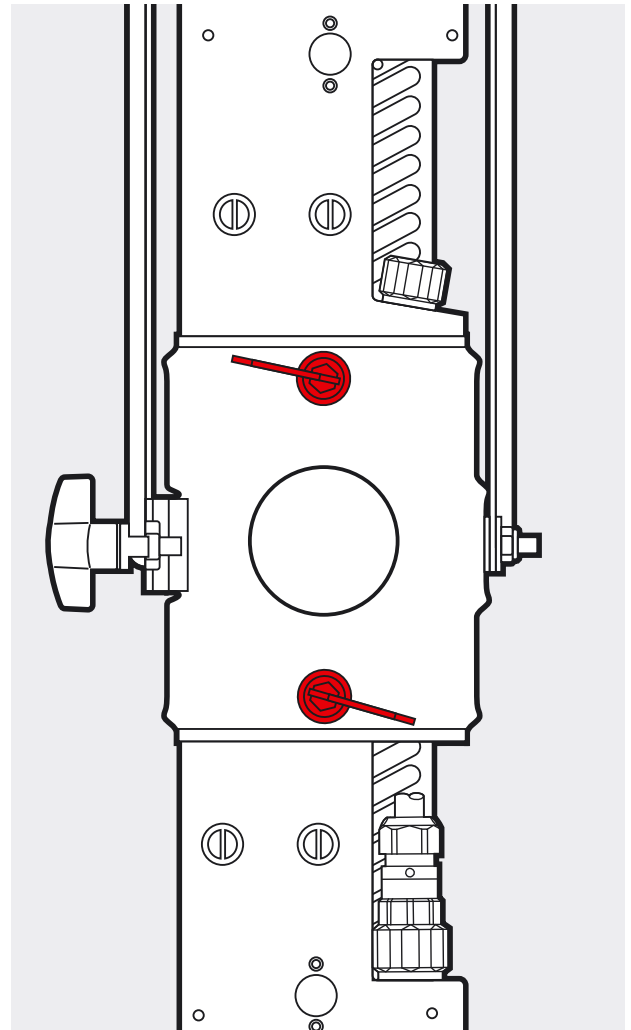
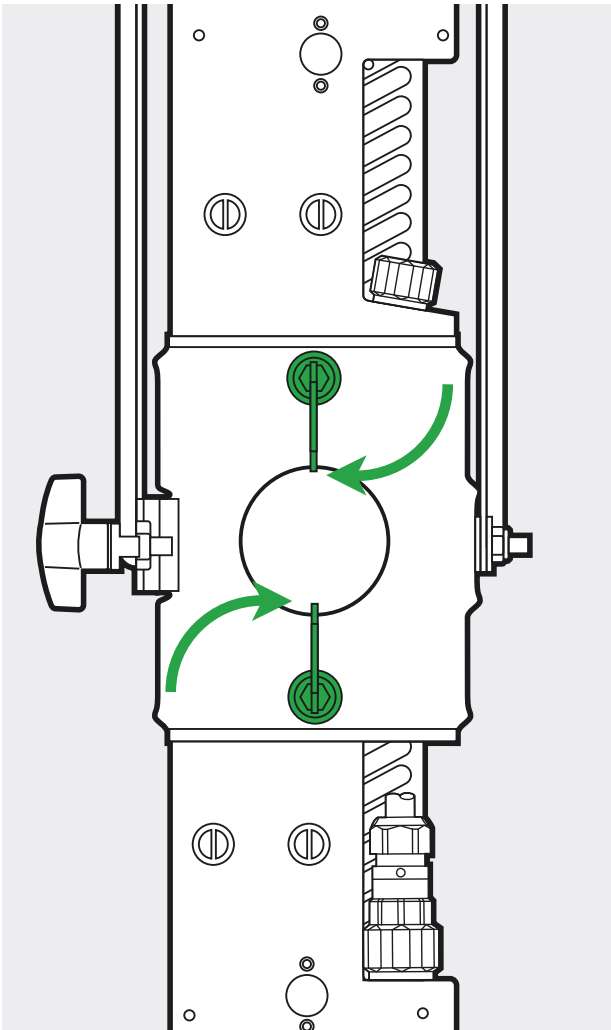

ALWAYS secure the lamp to the truss, pipe e.t.c. with two safety bonds. One attached to the lamp through the safety point shown in fig 1 the other attached to the LAMP yolk through the safety point shown in fig 2. NEVER through or to the RIGGING yoke.

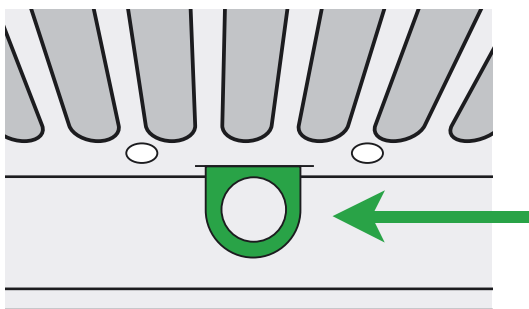

fig 1

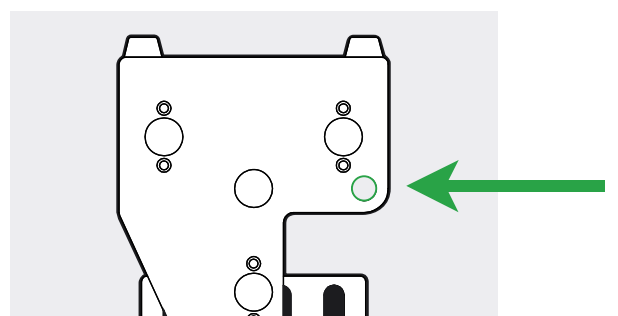

fig 2

SET UP

1. Select appropriate dimmer curve

The BB4 offers a choice of two dimmer curves.

1 LINEAR - the output increases directly with dmx input.

2 ENHANCED - the first 10% of the output is controlled over the first 50% of the DMX input.

First press the button under the MORE legend.



Then press the PROFILE button.

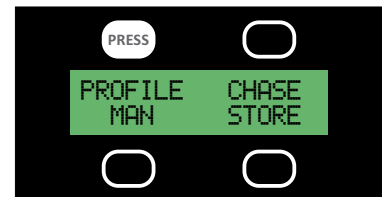

Then select the appropriate dimmer curve.
linear LIN.

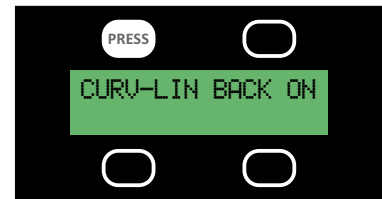

Or enhanced ENH.



2 Disable or enable user interface backlight

Whilst in PROFILE you may choose to switch off the user interface backlight. When you press the button above BACK ON the legend will change to BACK OF and the backlight will go out 5 seconds after the interface is last used, though the backlight will come back on whenever any button is pressed.

When you press the button above BACK OF the legend will change to BACK ON and the backlight will remain lit constantly.

BACK ON shows the current status of the backlight



3 Select appropriate operating mode

The BB4 will give you a choice of ten operating modes. These modes will enable you to set up the lamp in the most appropriate way for the many different jobs the lamp will be used for. The nuts and bolts of the modes are described in detail in pages 12 to 15.

To select a mode

Keep the button below the MODE legend depressed go through the modes, just before the one you desire stop, then press once.



4 Select appropriate DMX address

First press the button above the ADDR legend.



Then change the address using the 100s,10s & 1s buttons.

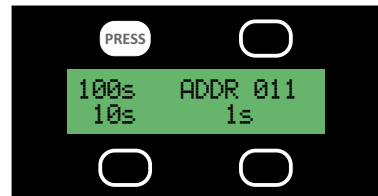

5 inverting the cells

Should you wish to change the running order of the cells so that instead of running.



they run



Press the button above 1NORM4

1NORM4 shows the current orientation of the cells.

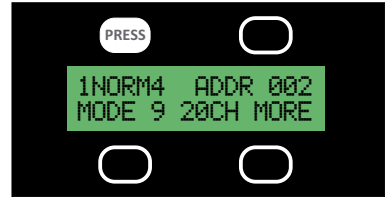

THIS IS AN EXTREMELY USEFUL FUNCTION IF SOMEONE HAS RIGGED THE LAMP THE WRONG WAY ROUND!

To return them to



press the button above 4INVRT1.



6 locking off the interface

When you are satisfied that you have set up all the lamp's parameters to your liking it is possible to lock off the interface so that you dont inadvertently change anything when focusing etc.

To lock off the interface depress the MORE and ADDR buttons simultaneously and the MORE will change to LOCK.

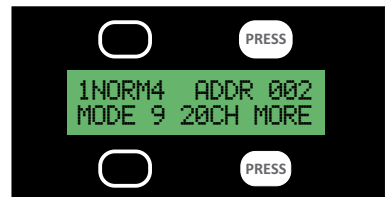

To unlock the interface depress the LOCK and ADDR buttons simultaneously and the LOCK will change to MORE.



THE OPERATING MODES

The BB4 has 10 different operating modes to suit different uses, programming styles and dmx configurations.

MODE 1 - 3 channels 8 bit

The most simple, ideal for fast programming or limited dmx line space and as a node on a media server. All 4 cells are treated as 1 with the 3 channels red, green & blue affecting the whole lamp

- ch1 - red all cells
- ch2 - green all cells
- ch3 - blue all cells

MODE 2 - 6 channels 16 bit

Ideal for fast programming or limited dmx line space and as a node on a media server, with a greater resolution over the colours. All 4 cells are treated as 1 with the 6 channels red, green & blue affecting the whole lamp.

- ch1 - red high byte all cells
- ch2 - red low byte all cells
- ch3 - green high byte all cells
- ch4 - green low byte all cells
- ch5 - blue high byte all cells
- ch6 - blue low byte all cells

MODE 3 - 5 channels 8 bit

Ideal for fast programming or limited dmx line space with overall dimming & strobe control. All 4 cells are treated as 1 with the 5 channels dim, strobe, red, green & blue affecting the whole lamp

- ch1 - master intensity all cells
- ch2 - strobe all cells
- ch3 - red all cells
- ch4 - green all cells
- ch5 - blue all cells

MODE 4 - 9 channels 16 bit

Ideal for fast programming or limited dmx line space with overall dimming & strobe control and a greater resolution in control over the dimming and colours.

All 4 cells are treated as 1 with the 5 channels dim, strobe, red, green & blue affecting the whole lamp.

- ch1 - master intensity high byte all cells
- ch2 - master intensity low byte all cells
- ch3 - strobe all cells
- ch4 - red high byte all cells
- ch5 - red low byte all cells
- ch6 - green high byte all cells
- ch7 - green low byte all cells
- ch8 - blue high byte all cells
- ch9 - blue low byte all cells

MODE 5 - 12 channel 8 bit

Ideal for use with media servers where dmx line space may be a consideration. Each cell can be individually coloured with its own red green blue channels. (most useful when each cell is patched individually -3ch)

- ch1 - red cell 1
- ch2 - green cell 1
- ch3 - blue cell 1
- ch4 - red cell 2
- ch5 - green cell 2
- ch6 - blue cell 2
- ch7 - red cell 3
- ch8 - green cell 3
- ch9 - blue cell 3
- ch10 - red cell 4
- ch11 - green cell 4
- ch12 - blue cell 4

Mode 1 - 3 ch 8 bit



Mode 2 - 6 ch 16 bit



Mode 3 - 5 ch 8 bit

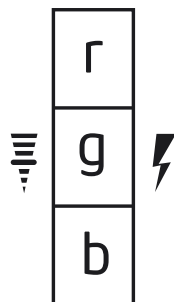

Mode 4 - 9 ch 16 bit

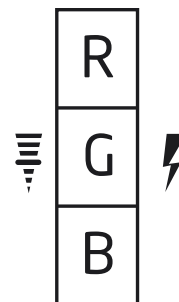

Mode 5 - 12 ch 8 bit



MODE 6 - 24 channel 16 bit

Ideal for use with media servers, with a greater resolution over the colours.

Each cell can be individually coloured with its own red green blue channel. (most useful when each cell is patched individually -6ch)

- ch1 - red high byte cell 1
- ch2 - red low byte cell 1
- ch3 - green high byte cell 1
- ch4 - green low byte cell 1
- ch5 - blue high byte cell 1
- ch6 - blue low byte cell 2
- ch7 - red high byte cell 2
- ch8 - red low byte cell 2
- ch9 - green high byte cell 2
- ch10 - green low byte cell 2
- ch11 - blue high byte cell 2
- ch12 - blue low byte cell 2
- ch13 - red high byte cell 3
- ch14 - red low byte cell 3
- ch15 - green high byte cell 3
- ch16 - green low byte cell 3
- ch17 - blue high byte cell 3
- ch18 - blue low byte cell 3
- ch19 - red high byte cell 4
- ch20 - red low byte cell 4
- ch21 - green high byte cell 4
- ch22 - green low byte cell 4
- ch23 - blue high byte cell 4
- ch24 - blue low byte cell 4

MODE 8 - 27 channel 16 bit

High resolution colour control over each individual cell with a strobe and a high resolution master intensity having overall control over all 4 cells.

- ch1 - master intensity high byte all cells
- ch2 - master intensity low byte all cells
- ch3 - strobe all cells
- ch4 - red high byte cell 1
- ch5 - red low byte cell 1
- ch6 - green high byte cell 1
- ch7 - green low byte cell 1
- ch8 - blue high byte cell 1
- ch9 - blue low byte cell 1
- ch10 - red high byte cell 2
- ch11 - red low byte cell 2
- ch12 - green high byte cell 2
- ch13 - green low byte cell 2
- ch14 - blue high byte cell 2
- ch15 - blue low byte cell 2
- ch16 - red high byte cell 3
- ch17 - red low byte cell 3
- ch18 - green high byte cell 3
- ch19 - green low byte cell 3
- ch20 - blue high byte cell 3
- ch21 - blue low byte cell 3
- ch22 - red high byte cell 4
- ch23 - red low byte cell 4
- ch24 - green high byte cell 4
- ch25 - green low byte cell 4
- ch26 - blue high byte cell 4
- ch27 - blue low byte cell 4

MODE 7 - 14 channel 8 bit

Colour control over each individual cell with a master intensity and strobe having overall control over all 4 cells.

- ch1- master intensity all cells
- ch2 - strobe all cells
- ch3 - red cell 1
- ch4 - green cell 1
- ch5 - blue cell 1
- ch6 - red cell 2
- ch7 - green cell 2
- ch8 - blue cell 2
- ch9 - red cell 3
- ch10 - green cell 3
- ch11 - blue cell 3
- ch12 - red cell 4
- ch13 - green cell 4
- ch14 - blue cell 4

Mode 6 - 24 ch 16 bit

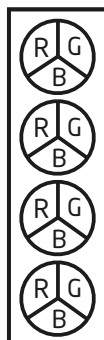

Mode 7 - 14 ch 8 bit

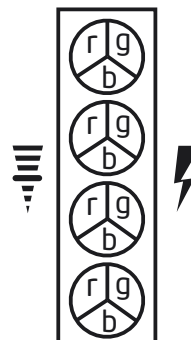

Mode 8 - 27 ch 16 bit

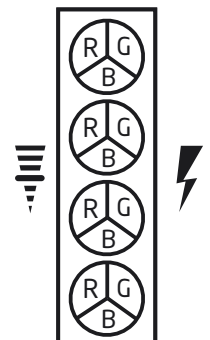

MODE 9 20 channel 8 bit

Ideal for control over all aspects of programming where dmx line space may be a consideration. For each cell there is individual control over master intensity, strobe and red green colour mixing. (most useful when each cell is patched individually -5ch).

- ch1- master intensity all cells 1
- ch2 - strobe all cells 1
- ch3 - red cell 1
- ch4 - green cell 1
- ch5 - blue cell 1
- ch6- master intensity all cells 2
- ch7 - strobe all cells 2
- ch8 - red cell 2
- ch9 - green cell 2
- ch10 - blue cell 2
- ch11- master intensity all cells 3
- ch12 - strobe all cells 3
- ch13 - red cell 3
- ch14 - green cell 3
- ch15 - blue cell 3
- ch16- master intensity all cells 4
- ch17 - strobe all cells 4
- ch18 - red cell 4
- ch19 - green cell 4
- ch20 - blue cell 4

Mode 9 - 20 ch 8 bit

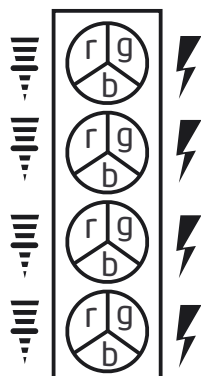

Mode 10 - 36 ch 16 bit

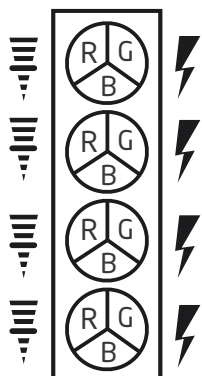

MODE 10 36 channel 16 bit

Ideal for control over all aspects of programming with high resolution master intensity, high resolution colour control and a strobe control over each individual cell. (most useful when each cell is patched individually - 9ch).

- ch1 - master intensity high byte cell 1
- ch2 – strobe cell 1 low byte cell 1
- ch2 – strobe cell 1
- ch4 - red high byte cell 1
- ch5 - red low byte cell 1
- ch6 - green high byte cell 1
- ch7 - green low byte cell 1
- ch8 - blue high byte cell 1
- ch9 - blue low byte cell 1
- ch10 - master intensity high byte cell 2
- ch11 - master intensity low byte cell 2
- ch12 – strobe cell 2
- ch13 - red high byte cell 2
- ch14 - red low byte cell 2
- ch15 - green high byte cell 2
- ch16 - green low byte cell 2
- ch17 - blue high byte cell 2
- ch18 - blue low byte cell 2
- ch19 - master intensity high byte cell 3
- ch20 - master intensity low byte cell 3
- ch21 – strobe cell 3 cell
- ch22 - red high byte cell 3
- ch23 - red low byte cell 3
- ch24 - green high byte cell 3
- ch25 - green low byte cell 3
- ch26 - blue high byte cell 3
- ch27 - blue low byte cell 3
- ch28 - master intensity high byte cell 4
- ch29 - master intensity low byte cell 4
- ch30 – strobe cell 4
- ch31 - red high byte cell 4
- ch32 - red low byte cell 4
- ch33 - green high byte cell 4
- ch34 - green low byte cell 4
- ch35 - blue high byte cell 4
- ch36 - blue low byte cell 4

MODES A GRAPHICAL OVERVIEW

MASTER
INTENSITY 

STROBE
CHANNEL 

Mode 1

3 ch 8 bit



Mode 2

6 ch 16 bit



Mode 3

5 ch 8 bit

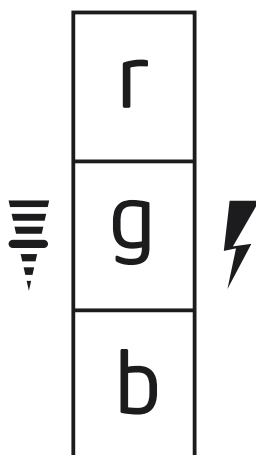

Mode 4

9 ch 16 bit

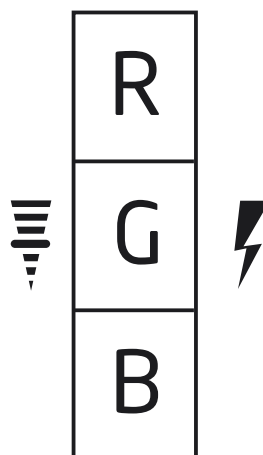

Mode 5

12 ch 8 bit

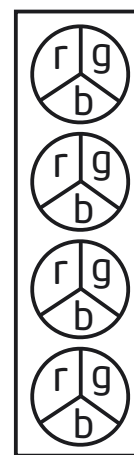

Mode 6

24 ch 16 bit

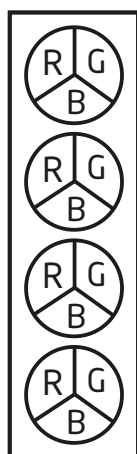

Mode 7

14 ch 8 bit

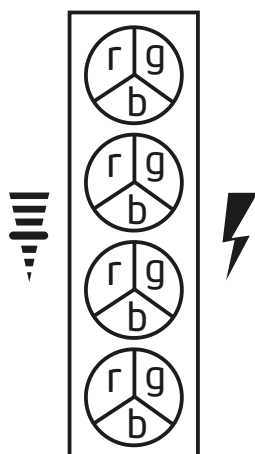

Mode 8

27 ch 16 bit

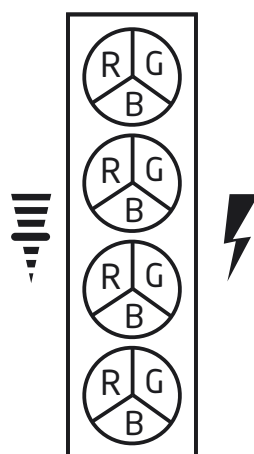

Mode 9

20 ch 8 bit

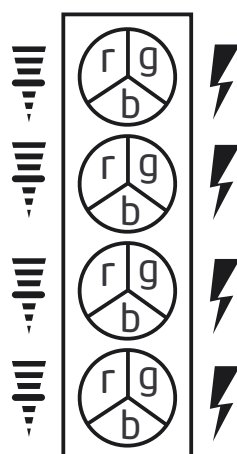

Mode 10

36 ch 16 bit

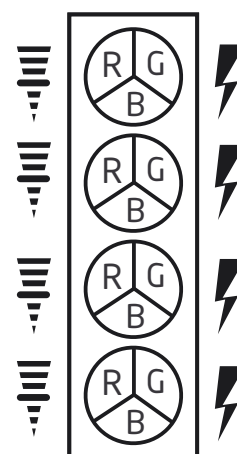

Stand alone functions

The BB4 is able to run in a stand alone mode without any need of data from a lighting desk. The light is capable of outputting up to 20 programmable memories and 1 chase that steps through these memories.

“The light must be in MODE 3 (5ch) for all the stand alone functions to work.”

Storing a DMX Input as a Memory

However if you have access to a lighting desk a quick and easy way to create multiple or complex memories is to give the light the desired colour information using a lighting desk or similar DMX generating device and use the STORE function.

- 1 Connect the light to the desk in the usual way making sure the address is correct and the lamp is in MODE 3.
- 2 Create the desired colour on the lighting desk.

3 Press the button underneath the MORE legend once.



4 Press the button underneath the STORE legend once.

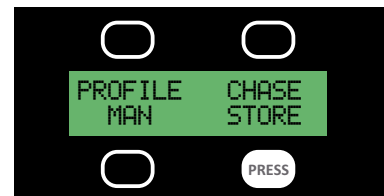

5 You should then assign this memory a number using the UP, DOWN buttons.



6 When you are happy this memory has been numbered correctly press the STORE button wait 3 seconds and the display will return to the main menu.



Creating a memory

1 press the button underneath the MORE legend once.



2 press the button underneath the MAN (manual) legend once.



3 press the button underneath the PROG MEM (program memory) legend once.

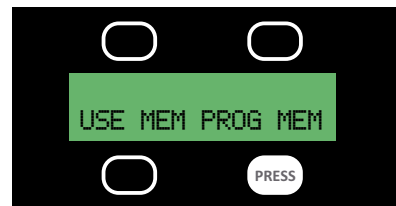

You are now presented with the first variable of your memory which is the Master Intensity (MINT). The default value for the MINT is 100% - intensity full.

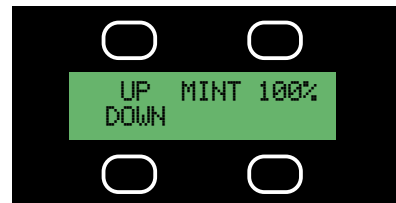

If you wish to alter this value use the buttons above and below the UP & DOWN legends until you have the desired % value.



4 When happy with the MINT value press the button above MINT once.



Next you are presented with STRB (strobe) the second variable of your memory which has a default value of 0% - no strobe.



In the same way if you wish to alter this value use the UP & DOWN buttons to give you the desired % value.

5 When happy with the STRB value press the button above STRB once.

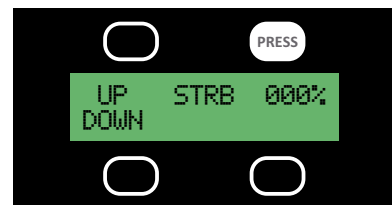

Now you are presented with the first colour RED (default 0%).



In the same way if you wish to alter this value use the UP, DOWN buttons to give you the desired %. If you require 100% press the DOWN button.

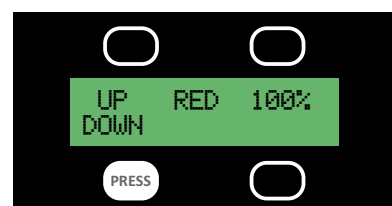

6 When happy with the RED value press the button above RED once.

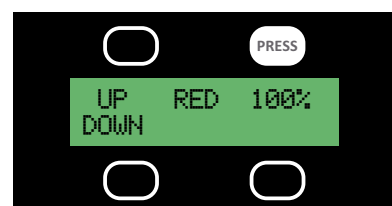

Next you are presented with the second colour GREEN (default 0%)

In the same way if you wish to alter this value use the UP, DOWN buttons to give you the desired %
If you require 100% press the DOWN button.

7 When happy with the GREEN value press the button above GREEN once.



Finally you are presented with the third colour BLUE (default 0%).

In the same way if you wish to alter this value use the UP, DOWN buttons to give you the desired %.
If you require 100% press the DOWN button.

8 When happy with the BLUE value press the button above BLUE once.



Now you are given the opportunity to store your memory. If you are satisfied with all the values you have inputted.



If however you think you may have made a mistake or you have just changed your mind then you can return to the start of the memory by pressing MEM button and repeating the above process.



If you are happy with your memory you should then assign it a number using the UP, DOWN buttons.



9 When happy with your memory number press STORE.



To Recall A Memory

1 Press the button underneath the MORE legend once then.

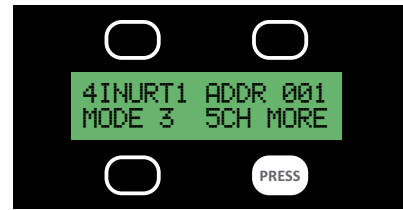

2 Press the button underneath the MAN (manual) legend once then.

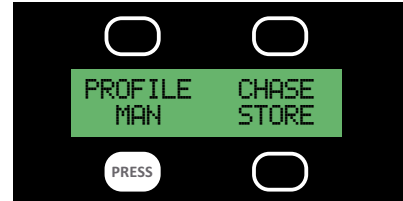

3 Press the button underneath the USE MEM (use memory) legend.

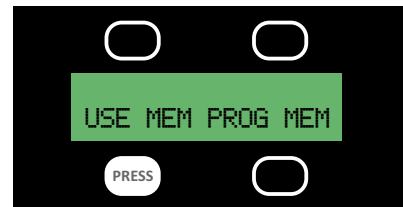

Now you will be offered the first memory MEM 01.
This will come on automatically.



4 To select any other memory simply use the UP, DOWN buttons until you find the memory you want.

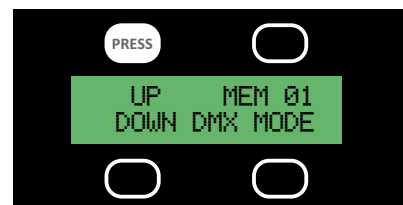

The memories will come on as you select them.

“ IF YOU WISH YOUR MEMORY TO COME ON AS SOON AS YOU GIVE THE LAMP POWER YOU WILL NEED TO PROGRAMME IT AS A TWO STEP CHASE WITH BOTH MEMORIES HAVING THE SAME VALUE”

To return to the main menu press the DMX MODE button

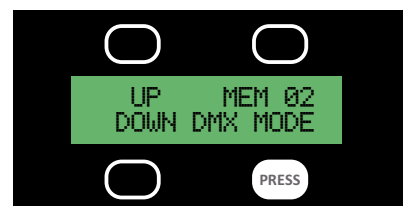

Programming a Chase

1 Ensure you have programmed all the memories that will go to make up the steps of your chase.

2 Press the button underneath the MORE legend once..



3 Press the button above the CHASE legend once.



Now the WAIT TIME will appear this is the first variable of the chase to be set. The WAIT TIME is the time period between cross fades that the colour is held constant for.



Select the appropriate time (in seconds) using the UP, DOWN buttons.

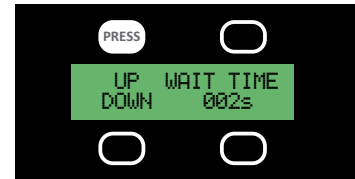

4 When you are happy with the WAIT TIME press the button above WAIT TIME once.

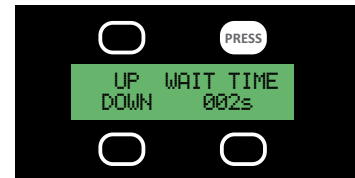

Now the XFADE TIME (cross fade time) will appear this is the second variable of the chase to be set. The XFADE TIME is the length of time the light takes to change from one colour to another.

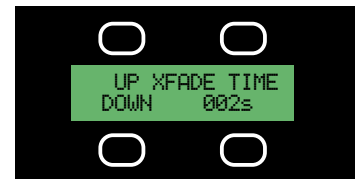

Select the appropriate time (in seconds) using the UP, DOWN buttons.

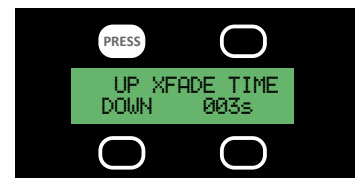

5 Once you are happy with the XFADE TIME press the button above XFADE TIME once.



Now CHASE STRT (chase start) will appear along with the option MEM 1. This will be the first step of your chase.

Choose which memory you would like to be the first step of your chase using the UP, DOWN buttons.

6 Once you are happy with the memory that will be your first step press the button above CHASE STRT.



Now CHASE END will appear along with the option MEM 1. This will be the last step of your chase. The chase will run through all the memories numbered between the first and last step.

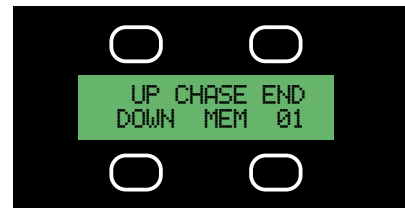

Choose which memory you would like to be the last step of your chase using the UP, DOWN buttons.

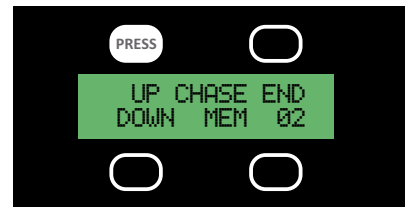

7 Once you are happy with the memory that will be your last step press the button above CHASE END once.

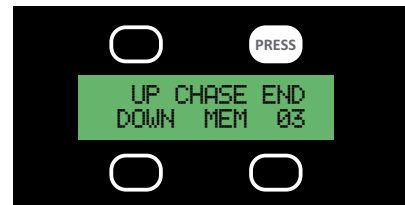

Now you will be offered the option USE CHASE, if you wish to simply press yes.

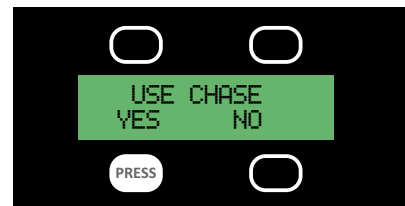

The Interface will now say CHASE RUNNING. When you wish to end or change the chase press MENU.



If you leave a chase running when the light is powered down the chase will resume as soon as the light is powered back up again.

! If the chase does not run try rerecording the first step again

BB4 cell orientation

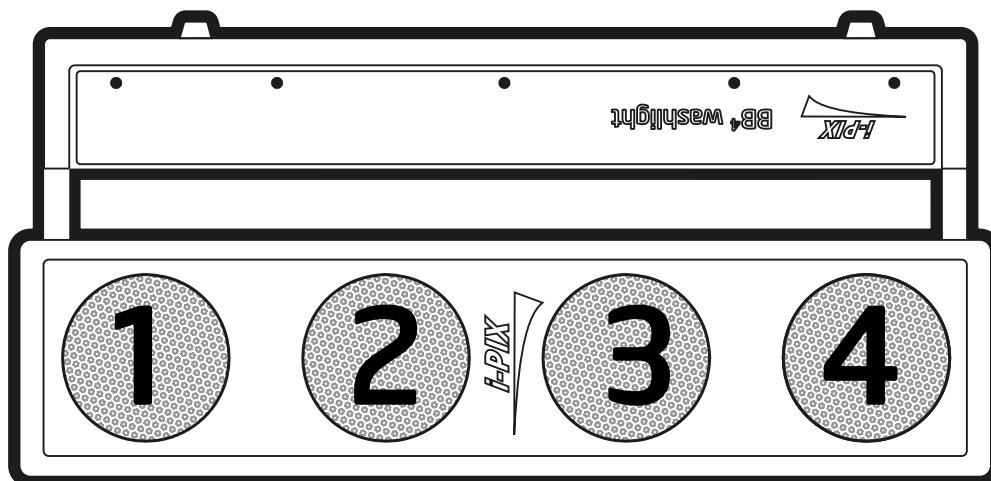

BB 4 Washlight tech spec

Dimensions

Length	600 mm
Height	301 mm on rubber feet
Width	147 mm
Weight	13.5Kg total
Yoke:	3 KG
Power Box:	4.5Kg
BB4 batten:	6Kg

Mechanical design/ materials used

Batten	Aluminium shrouded finned diagonal heatsink
Power box	Aluminium with steel base
Yoke	Folded and welded steel
Finish	Electro static powder coated black satin

Rigging

Style	16 ¼ turn camloc fasteners
Number of positions	8 rigging locations on yoke
Accessory holder	Fitted with sprung retention flap
Conventional mounts	2 of 12mm bolt holes fitted at each yoke end

Note: unit comes with three scaffold clamp adaptors to accept 12mm bolts, equipped with two camloc ¼ turn bolts

Electrical connections for mains and data in/out

Combined power and data connection	
Input	Chassis mounted male IP67 6 pin
Output	Chassis mounted female IP67 6 pin
Fixture feed	Chassis mounted female IP67 7 pin
Fixture feed	Trailing 7 pin male
Mains and data	
Input inline female	6 pin Ceep
Output	6 pin Ceep

Electrical

120 watts total power on full.

Input	90- 265 Volt 50/60 Hz
Power	0.5 amps @ 240 volts
Fuse	20mm x 5mm slow blow 4 amp
Output to fixture	15 volts max

Data type USITT DMX512-A

Note; units comes complete with 16 amp cee form plug and 5 pin xlr male. A 1 metre combined power cable link is also supplied.

Control RGB additive colour mixing

DMX channels	3 channels minimum 36 channels maximum
User interface	weatherproof backlit lcd display with four membrane switches

Modes	8 bit	standard resolution
	1	1 x RGB over 4 cells
	3	1 x RGB over 4 cells with an overall master and strobe
	5	4 x RGB
	7	4 x RGB with an overall master and strobe
	9	4 x RGB each with individual master and strobe
	16 bit	high resolution (recommended)
	2	1 x RGB over 4 cells
	4	1 x RGB over 4 cells with an overall master and strobe
	6	4 x RGB
	8	4 x RGB with an overall master and strobe
	10	4 x RGB each with individual master and strobe

note 16 bit for every channel bar strobe which runs as 8 bit

Note; please refer to power box or user instructions or website for channel allocation details. Most popular lighting desks have personalities available for download from their respective websites or the downloads section on our website.

Light Engine

Source	Customised lamina Titan RGB LED
Wavelengths	Red 625 Nm +/- 2.5 Nm
	Green 517 Nm +/- 2.5 Nm
	Blue 452.5 Nm +/- 2.5 Nm
Optics	4 x evenly spaced 20 degree optic

note: further photometric data and IES files are available for download from our website

Thermal characteristics

Fixture front	Passive convection cooled
Power box	Force air cooled via low airflow/ low noise fans, mounted to the base

Operating temperature

Minimum	-20 degrees C
Maximum	+ 46 degrees C

Weather protection

Fixture front	Hermetically sealed to IP67
Power box	Mounted horizontally facing upwards
	Rated to IP65H
Humidity max	20% ~ 90% RH non-condensing

Approvals & Compliance

BS EN 55103-1 Harmonics	BS EN 55103-2 Immunity	BS EN 61000-3-2 Emissions
USA / Canada ETL pending		
Lead and mercury free return to manufacturer for recycling		

IP Protection Patents filed in USA

Manufactured in the United Kingdom by



We reserve the right to improve this fixtures design.

Remove all burrs | Surface to be a clean and sharp edges | finish and crevice free
 Tolerances unless otherwise stated:
 Up to 250 ± 0.10
 Over 250 up to 1000 ± 0.25
 Over 1000 ± 0.75

IF IN DOUBT ASK

DO NOT SCALE FROM PRINTS

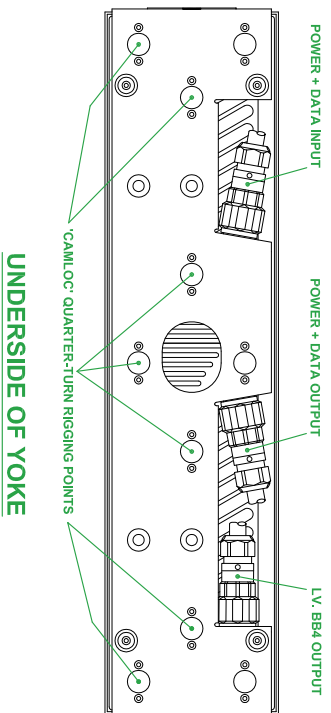
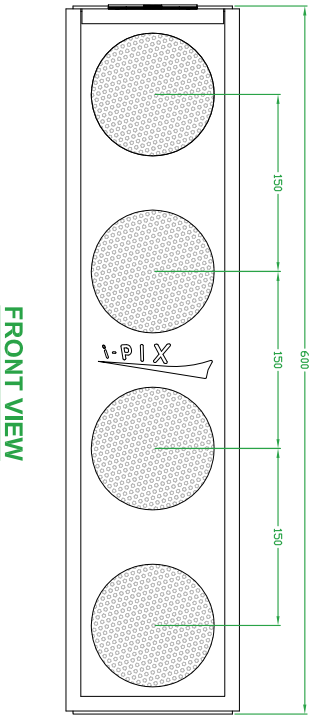
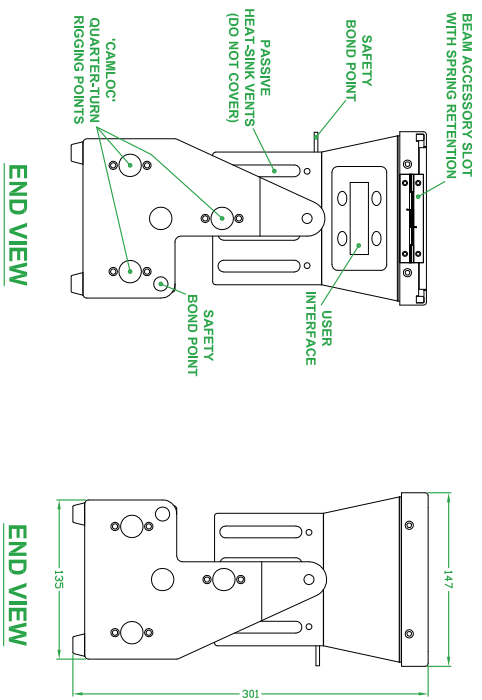
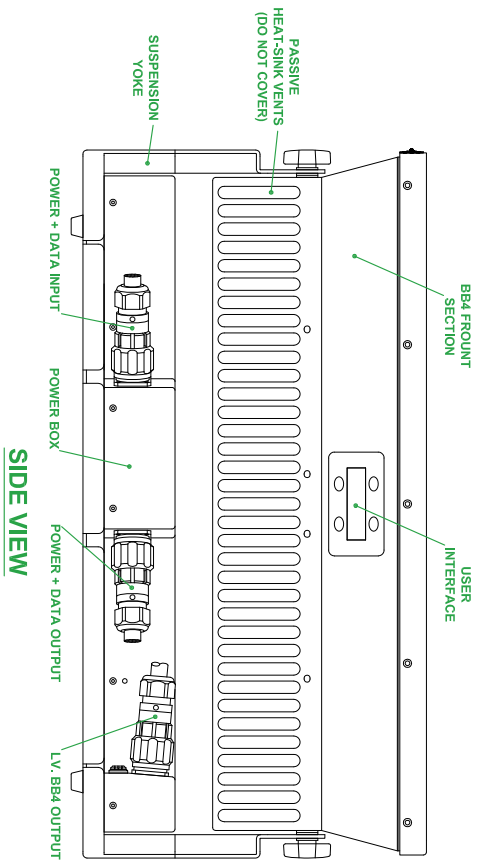

Revisions date - name - description:

Unit 376 3rd Floor
 Broadstone Knowledge Mill
 Broadstone Mill
 Houldsworth Village
 Cheshire
 SK5 7DL



Drawn by - date R. Wray - 10/10/07	Chk./App. by - date	Drawing number:
Customer: HPK		Title:
Project: BB BATTERN LIGHT		CUSTOMER DRAWING 4 WAY BATTERN
Drawing type:	Sheet: 1 of 1	Issue: 1
Scale: 1:1		File: CUSTOMER 4 WAY BATTERN.dwg

TROUBLE SHOOTING

DISCLAIMER: Please note that the information contained in this trouble-shooting guide is generalized in nature & cannot account for all possibilities. Any proposed remedies for specific situations should not be considered as absolute or all encompassing. Please seek professional assistance if there is any doubt as to the efficacy of a remedy or of the exact nature of any encountered problem. I-pix provides the information contained herein only as a guide.

No response from the light

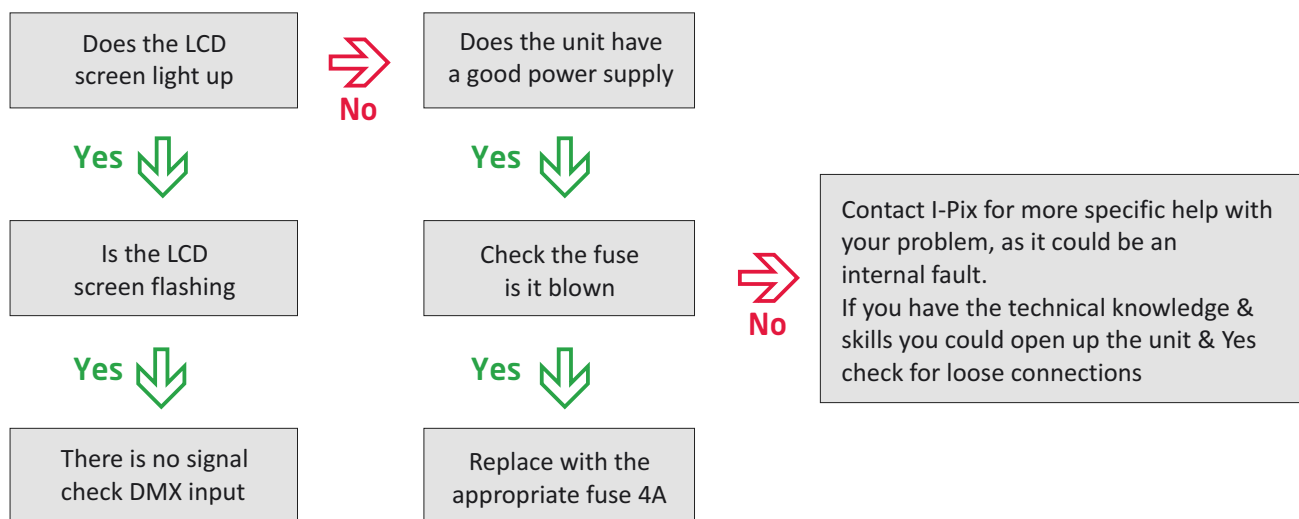

Mains supply keeps tripping out blowing fuses:

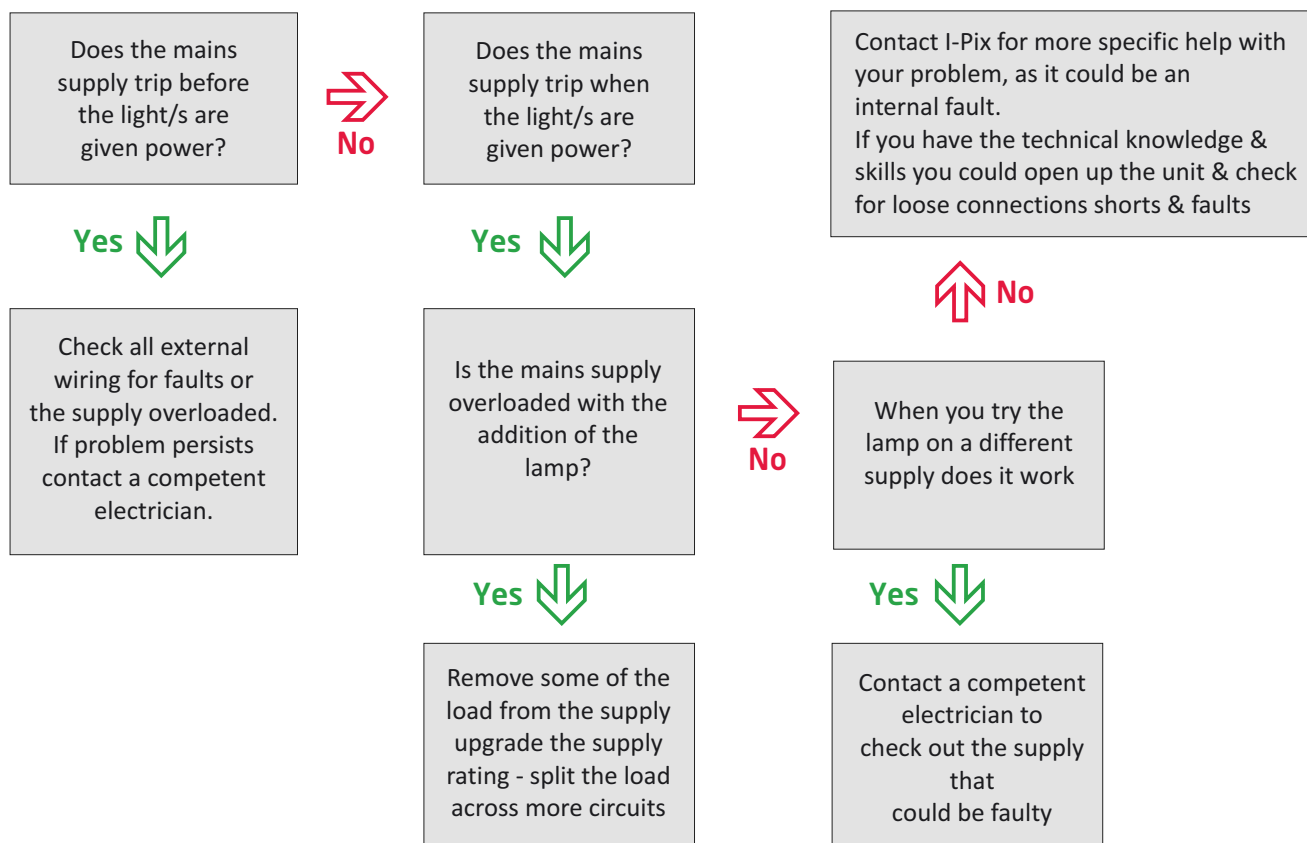

TROUBLE SHOOTING

The fuse on a unit repeatedly blows

- Are you fitting right rating/type of fuse into unit?
- Contact I-pix for more specific help with your problem, there may be an internal fault in the unit.
- If you have the technical knowledge/skills you could look inside the unit and check the internal wiring for a loose connections/shorts and also the power supply is working with a 15v output when there is no load connected to it.

Dmx trouble shooting

The obvious

- It is good practice to connect data line and terminate before switching on device.
- Is the dmx line fitted to a buffer and data is being received
- Is the dmx data line fitted with a line termination?
- Does the unit's dmx mode set-up match the personality/ profile for the console provided?
- Note: the LCD screen flashes intermittently when no data is present

QUICK RESET

An easy way of returning the light to its default settings.

Before the light is given any power hold down both both buttons on the left hand side of the interface.

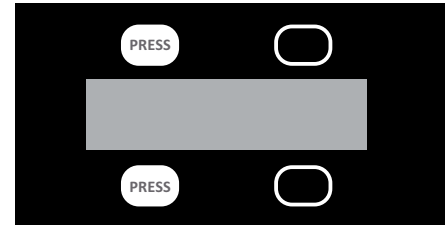

Keep the buttons held down as you give the light power.

When you see screen with the black boxes let go of the buttons and the next screen will appear. If you do not let go it will stay locked until you let go.

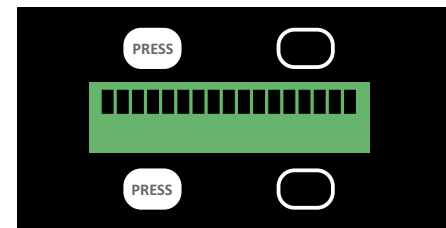

Then the light will return to MODE 10 ADDR 001



This is a fast way of readdressing a light, that will save you a few button presses

RoHS AND WARRANTIES

I-PIX BB4s COMPLY WITH RoHS RESTRICTIONS

I-PIX BB4s are compliant with all of the criteria proposed by the European RoHS directive 2002/95/EC for hazardous material content in electronic and electrical equipment as listed in Annex 1A and 1B of the WEEE Directive.

In addition to containing no mercury, the LED light engines have the following environmental advantages over traditional light sources:

- High energy efficiency
- Long lifetime
- Fully dim-able
- Very low IR and UV radiation

For attachment of electrical connections I-Pix use lead free solder

WARRANTY STATEMENT

I-Pix (seller) extends warranty on all the electronics in the BB4 produced by the Seller for two (2) years from original date of shipment, that the goods sold hereunder are new and free from substantive defects in workmanship and materials. This warranty extends only to the Buyer and not to indirect purchasers or users. Sellers liability under the foregoing warranty is limited to replacement of goods or repair of defects or refund of the purchase price at the Sellers sole option. The above warranty does not apply to defects resulting from the improper or inadequate maintenance, unauthorized modification, improper use or operation outside of Sellers specifications for the product, abuse, neglect, or accident. THE ABOVE WARRANTY IS EXCLUSIVE AND NO OTHER WARRANTY, WHETHER WRITTEN OR ORAL, IS EXPRESSED OR IMPLIED. I-PIX SPECIFICALLY DISCLAIMS THE IMPLIED WARRANTIES OF MERCHANTABILITY AND FITNESS FOR A PARTICULAR PURPOSE - I-PIX Jan 01, 2009

WARRANTY STATEMENT

I-Pix (seller) extends warranty on all the L.E.Ds in the BB4 produced by the Seller for one (1) year from original date of shipment, that the goods sold hereunder are new and free from substantive defects in workmanship and materials. This warranty extends only to the Buyer and not to indirect purchasers or users. Sellers liability under the foregoing warranty is limited to replacement of goods or repair of defects or refund of the purchase price at the Sellers sole option. The above warranty does not apply to defects resulting from the improper or inadequate maintenance, unauthorized modification, improper use or operation outside of Sellers specifications for the product, abuse, neglect or accident. THE ABOVE WARRANTY IS EXCLUSIVE AND NO OTHER WARRANTY, WHETHER WRITTEN OR ORAL, IS EXPRESSED OR IMPLIED. I-PIX SPECIFICALLY DISCLAIMS THE IMPLIED WARRANTIES OF MERCHANTABILITY AND FITNESS FOR A PARTICULAR PURPOSE - I-PIX Jan 01, 2009



i-PIX



SERVICE CONTACT DETAILS

Broadstone Mill
Broadstone Road
Houldsworth Village
Cheshire
SK5 7DL
[Located 4 miles from Manchester airport and the city centre]

Tel: 44 (0)161 443 4140
E-mail: service@i-pix.com

www.i-pix.com