



Center for Entrepreneurship & Technology
University of California, Berkeley

The Electric Vehicle Battery Landscape: Opportunities and Challenges

Center for Entrepreneurship & Technology (CET)
Technical Brief

Number: 2009.9.v.1.1

Revision Date: December 21, 2009

Justin Amirault, Joshua Chien, Saurabh Garg, Drew Gibbons,
Ben Ross, Maureen Tang, Jia Xing
Ikhlaq Sidhu (PI), Phil Kaminsky, Burghardt Tenderich



UNIVERSITY OF CALIFORNIA, BERKELEY

Abstract

The battery represents arguably the most important and most technically challenging component of the electric vehicle (EV) ecosystem. Within the battery market are intriguing issues such as battery type and chemical compilation; performance and efficiency; cost; market demand and environmental concerns.

This brief provides an overview of the current state of battery technology and the EV battery industry, focusing on lithium-ion (Li-ion) technologies. Part A provides an overview of the battery technology and ecosystem, dissecting the battery and defining components, addressing the various chemistries and performance comparisons, as well as market demand. Part B offers performance and cost models, Part C delves into the environmental impact of batteries, and Part D considers additional issues such as the availability of raw materials from a physical and political perspective and future trends within the EV battery ecosystem. The document concludes with key findings within these aforementioned areas. Details of the mathematical models used in this report are offered in the Appendix.

Contents

Introduction	1
Part A: Overview of Battery Technologies for Electric Vehicles (EVs)	2
1. Introduction to Lithium-ion Battery Technology	2
2. Performance Fundamentals for Lithium-ion Batteries.....	4
3. Selected Lithium-ion Chemistries	5
4. Market Demands.....	6
Part B: Performance and Cost Models	8
1. Battery Weight Model.....	8
2. Battery Manufacturing Cost Analysis	9
2.1. Summary of Battery Manufacturing Costs	12
2.2. Use Phase Cost Analysis	14
3. Cost-based Selection Criteria for Choice	18
3.1. Battery Chemistry Selection Criteria	18
4. Electricity Cost Considerations.....	19
Part C: Environmental Impact Assessment for Batteries	24
Part D: Additional Considerations for EV Battery Manufacture	26
1. Raw Materials and Potential Supply Issues	26
2. Future Trends in the EV Battery Ecosystem	27
Conclusions	28
References	30
Appendix	32
Biographies.....	41
About UC Berkeley Center for Entrepreneurship & Technology	42

Introduction

EV battery manufacturing is currently dominated by several well-established technology companies in Asia, as shown in Figure 1. Leveraging long-standing success as leaders in consumer electronic battery manufacturing, these companies have begun to penetrate the small electric vehicle (EV) market and have taken the most significant first steps in R&D and establishing key partnerships to implement their products.

COMPANY	HQ	FACTORY	PARTNER	AUTO MAKER
A123	US	China	GE	Think
AESC (NEC)	Japan	Japan	Nissan	Nissan, Subaru
BYD	China	China	n/a	BYD
GS - YUASA	Japan	Japan	Mitsubishi Motor	Mitsubishi
Hitachi	Japan	Japan	Hitachi, Shinkobe	GM
LG	Korea	Korea	Compact Power	n/a
Panasonic EV	Japan	Japan	Toyota	Toyota
Saft	France	France	Johnson Control	GM,Ford,Daimler
Samsung	Korea	Korea	BOSCH	n/a
Sanyo	Japan	Japan	Continental	Honda, VW
SK	Korea	Korea	n/a	n/a

Figure 1: Partnerships in the current battery ecosystem.¹

Globally, the push for EV battery technology and manufacturing capabilities has attracted billions of dollars in venture and commercialization funding. From Warren Buffett's recent \$230 million investment in Chinese company BYD to A123's recent closing of \$69 million to ramp up manufacturing operations, the optimism displayed by the private investment community for EVs is quite compelling, especially given today's economic climate. Combined with over \$2 billion in U.S. stimulus funding intended for EV battery technology, this industry will likely be one of the few to see strong investment in the near term. The growth rate of the EV battery market is heavily debated, but most estimates put the EV market well above \$100 billion in the U.S. alone by somewhere late in the next decade.²

While battery manufacturing is a mature industry, its application for the use in EVs is very much in its infancy. Despite decreasing costs and improving performances across nearly all technologies, a definitive leader has yet to emerge as battery efficiency is still elusive amongst manufacturers. While there are certainly promising technologies and companies that are attracting serious investors, it is still anybody's guess as to what will be "under the hood" in ten years. The bottom line is that there are many unknowns that will further shape the EV battery landscape over the next decade. How ecosystems develop in terms of location, scale and scope will play an integral role.

Part A: Overview of Battery Technologies for Electric Vehicles (EVs)

Many of the challenges and opportunities relating to EV batteries arise from the current state of battery technology. Thus, an understanding of the technology is essential before the broader business model implications can be understood. This chapter provides an overview of the science behind lithium-ion batteries, and discusses the performance and cost attributes of various chemistries that are currently on the market.

1. Introduction to Lithium-ion Battery Technology

Lithium-ion (Li-ion) batteries are attractive for electric vehicle (EV) applications because of their relatively high energy densities per unit mass, volume, and cost. As shown in Figure A-1, the lithium-based chemistries have three times the energy density of other systems like nickel metal-hydride and nickel-cadmium. Figure A-1 also shows that unlike nickel metal hydride, where there is only one set of components and chemical reactions, many different materials may be used for lithium-ion batteries. For example, the red line represents the energy available when lithium cobalt oxide (LCO) is used, while the pink line shows the energy available when the battery is made of lithium iron phosphate (LFP). This variation allows manufacturers to tailor their products to a specific application and provides a basis for competitive advantage for battery producers.

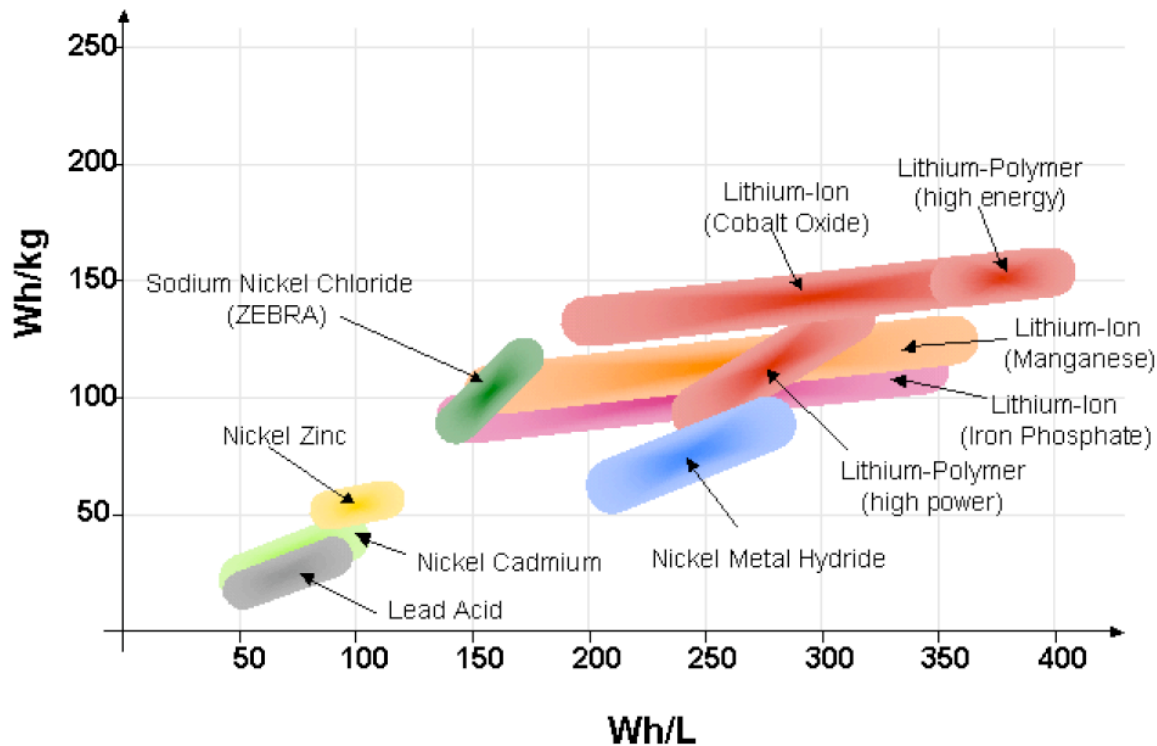

Figure A-1: Specific energy and energy density of various battery systems.

This figure shows the specific energy (Watt-hour per kilogram) versus the energy density (watt-hour per liter) of different battery systems. The curves show that lithium ion systems contain more energy than nickel metal hydride, nickel cadmium, or lead acid batteries. There are many different materials that may be used for lithium ion batteries. For more explanation, see the text.

Table A-1 provides an overview of critical components of batteries and their definitions. Figure A-2 shows a schematic of a representative Li-ion battery. As detailed in Figure A-2, lithium ions travel from the high-voltage cathode to the low-voltage anode, releasing energy as electricity. The choice of anode, cathode, and electrolyte create a variety of technological options with a complexity of advantages and disadvantages.

Table A-1: Essential Components and Key Terms for Batteries

Anode	Electrode that operates at low voltage. Lithium ions leave the anode when the battery discharges and enter the anode when the battery charges. Almost all commercial cells use graphite as the anode.
Cathode	Electrode that operates at high voltage. Lithium ions enter the cathode when the battery discharges and leave when the battery charges. Choice of cathode material is one of the most important factors in battery design.
Electrode	Solid material where lithium ions and electrons react, generating or consuming electricity. A battery contains two electrodes: the anode and the cathode.
Electrolyte	Liquid that fills the space between the electrodes. The electrolyte allows transport of lithium ions but not electrons. Li-ion electrolytes are a mixture of organic solvents and lithium salts.
Energy Density	The amount of energy, measured in joules or watt-hours, divided by the volume of the battery, measured in liters.
Specific Energy	The amount of energy, measured in joules or watt-hours, divided by the mass of the battery, measured in kilograms.
Capacity	The amount of lithium that can be stored in a battery material per mass, measured in milliamp-hours per gram. Energy is equal to capacity times voltage.

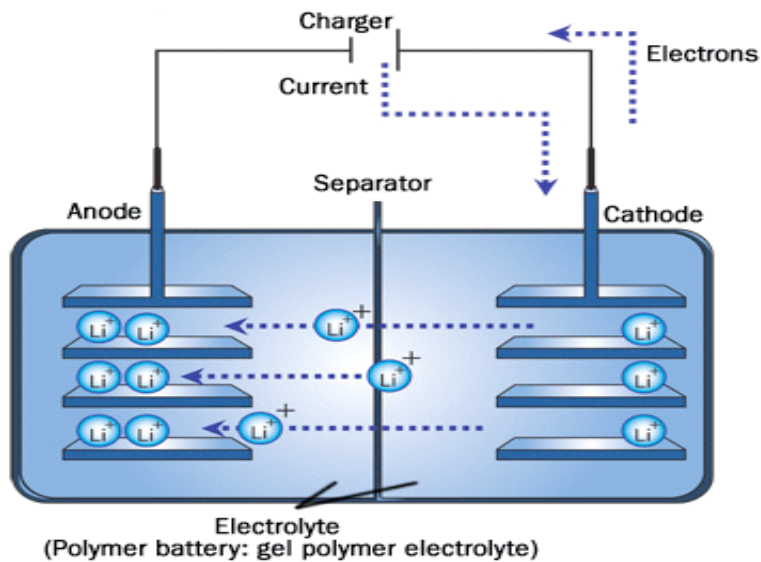

Figure A-2: Schematic of a lithium-ion battery.

2. Performance Fundamentals for Lithium-ion Batteries

One of the key factors determining the energy contained in a battery is the choice of materials for the anode and cathode. Figure A-3 shows the potential of several cathode materials versus capacity, which represents the amount of charge contained in the material.³ Both higher capacity and higher voltage mean more energy. Materials pictured are lithium manganese oxide spinel (LiMn_2O_4), lithium cobalt oxide (LiCoO_2), lithium iron phosphate (LiFePO_4), and lithium nickel-cobalt-manganese oxide ($\text{LiNi}_{1/3}\text{Mn}_{1/3}\text{Co}_{1/3}\text{O}_2$).

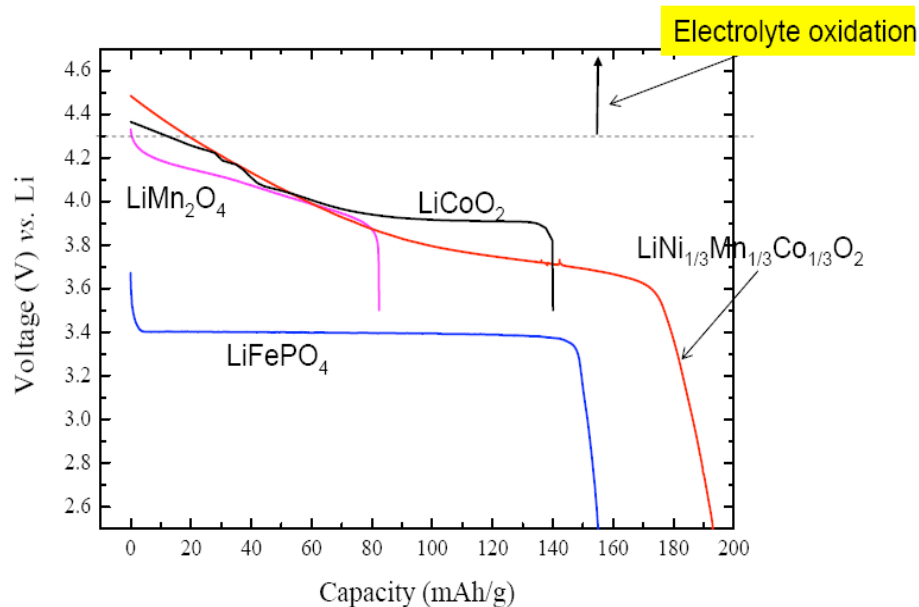

Figure A-3: Voltages of several cathode materials versus the capacity, or amount of charge contained in the material.

Multiplying the voltage by the capacity gives the energy; thus, higher voltage and higher capacity materials will contain more energy. Energy may be measured in terms of weight or volume; these metrics are called specific energy and energy density, respectively. The energy density and specific energy represent the maximum energy that may be obtained from a material. Depending on how the battery is designed and operated, the energy actually obtained may be less.

Power is also extremely important for EV applications. In contrast to specific energy, which is a material property, specific power depends strongly on factors like electrode thickness and the size of electrode particles, which may be controlled in the manufacturing process. Manufacturers have developed sophisticated proprietary manufacturing techniques, such as coating electrode particles with other materials that are more conductive,⁴ in order to increase the power density of their batteries.

3. Selected Li-ion Chemistries

The vast majority of batteries currently commercialized use graphitic carbon anodes, so this report does not consider alternative anode materials. Significantly more variety exists in the choice of cathode; in this report, the authors narrow the analysis to three cathode materials: lithium manganese oxide spinel (LiMn_2O_4 , or LMO), lithium iron phosphate (LiFePO_4 , or LFP), and lithium cobalt oxide (LiCoO_2 , or LCO).

LCO has historically been the leading lithium-ion battery technology and has the highest energy density of the currently commercialized materials.⁵ LCO, made by companies like Panasonic, is used in laptops and other portable electronics, as well as the Tesla Roadster. LMO is also a well-studied

material that is currently used in batteries produced by companies including LG and AESC. The energy density and operating voltage are lower than that of LCO.⁶ LFP is a lower-voltage, lower-energy material with the advantage that it is environmentally benign and less expensive. Iron phosphate batteries are produced by A123 Systems. For its vehicles in the San Francisco Bay Area, EV service provider Better Place has partnered with both A123 and AESC. Some product specifications for batteries using these materials are shown in Table A-2.⁷

Table A-2: Key Battery Specs for Selected Chemistries

Manufacturer	A123	CPI (LG)	Panasonic
Chemistry	Lithium iron phosphate	Lithium manganese oxide spinel	Lithium cobalt oxide
Specific Power (W/kg)	3000	2000	1200
Specific Energy (Wh/kg)	108	80	175
Power Density (W/L)	5800	N/A	N/A
Energy Density (Wh/L)	145	N/A	N/A
Cycle Life (10C, 100% DOD)	>1000 cycles	1000 cycles	>200 cycles
Operating Temperature	-30 to 60 °C	-30 to 60 °C	-30 to 60 °C
Calendar Life	10 yrs	N/A	15 yrs

(N/A indicates that information for this company was not available.)

4. Market Demands

The U.S. Advanced Battery Consortium (USABC) developed a set of specification goals for electric vehicles, illustrated in Figure A-4.⁸ The spider plot shows the consortium goals in blue, with the status of technology in red. The plot shows that while current technology meets recommended power requirements, energy and cost are quite far from the target. This plot suggests that currently the greatest barrier to the implementation of Li-ion batteries in EVs is cost. Recent trends, however, show a consistent decrease in the cost of Li-ion batteries with a concomitant increase in performance, as shown in Figure A-5.⁹

It is important to note: while safety concerns are not listed specifically under USABC's goals, safety is an important issue because lithium is highly reactive and the solvents inside batteries are flammable. Lithium iron phosphate has been shown to be more resistant to dangerous side-reactions than other cathode materials.¹⁰

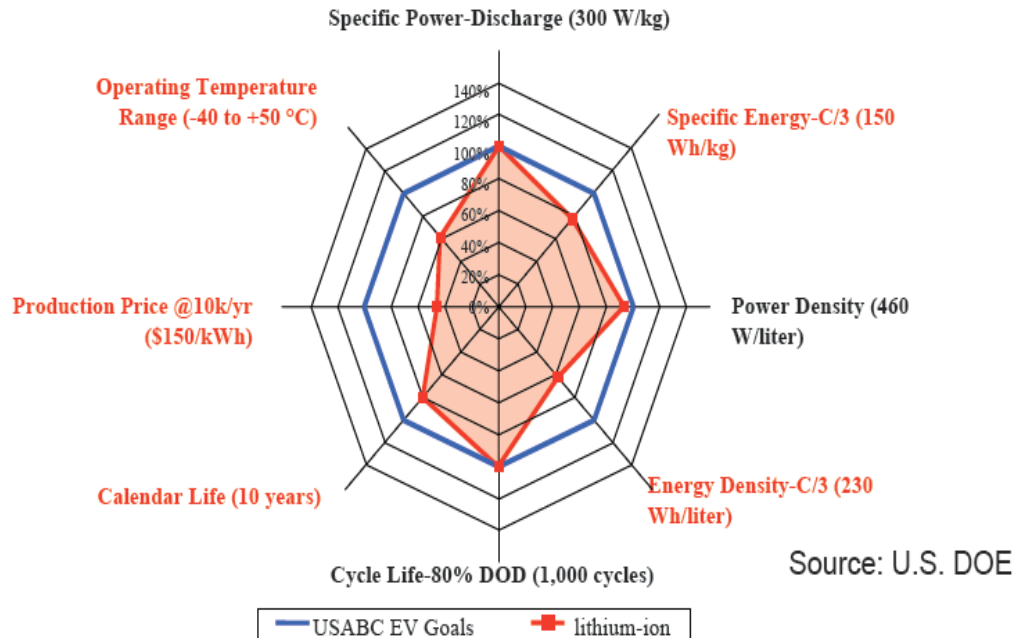

Figure A-4: Spider plot showing Department of Energy goals for lithium-ion batteries versus the current state of technology (in 2003).

The goals provided by the USABC implicitly assume the requirements of a particular ecosystem. For example, for an EV ecosystem that contains a strong infrastructure presence such as that proposed by EV infrastructure provider Better Place, the required energy (which converts to range) may be significantly less than for a no-infrastructure system. Similarly, higher costs may be acceptable if they can be defrayed over the life of the battery (with a leasing arrangement, for instance) rather than an up-front cost to the consumer. Business-model-related issues are discussed later in this brief.

The following assumptions were assumed based solely on the expected demands of the ecosystem. The resulting costs and battery weights are then derived from these inputs in the next section:

- A wide range of power will be demanded on the EV market. Sports cars and SUVs will represent the high end of power requirements, while small, light sedans will represent the low end.
- The energy required for any vehicle will be that which allows a 100 mile range.

10 Years of Progress With Lithium-Ion - 2x Energy Density and 1/10x Price

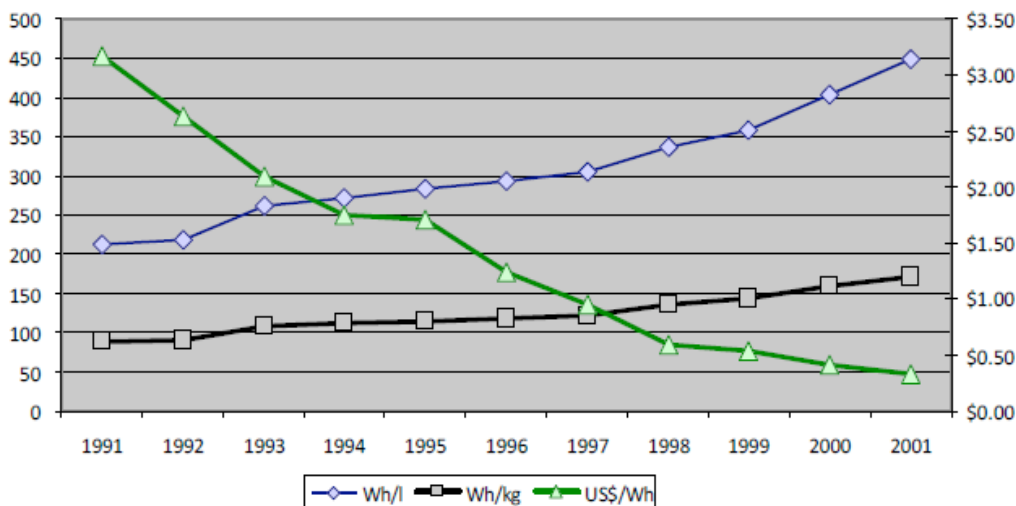

Figure A-5: Trends in cost and performance of lithium-ion batteries in recent years.

Part B: Cost and Performance Analysis for Electric Vehicle Batteries

1. Battery Weight Model

Details of the model used to determine EV batteries' weight and cost are available in the Appendix. To account for various types of EVs, the authors modeled a sports car, a sedan, and a sports utilities vehicle (SUV), with the critical parameters of each given in Table B-2. Three different battery chemistry types were considered for each vehicle class.

Table B-1 lists the battery weights for each combination of vehicle class and available technology. A 40% regenerative braking efficiency was assumed. Regenerative braking is a mechanism that reduces vehicle speed by converting some of its kinetic energy into a storable form of energy instead of dissipating it as heat as with a conventional brake, and the captured energy is stored for future use or fed back into a power system for use by other vehicles.¹¹

Table B-1 illustrates two important points. First, large weight differences exist between batteries for the different vehicle classes: an SUV requires roughly 2x the battery weight of a sports car regardless of chemistry. This will lead to similar increases in cost, as presented in the following section. Second, a single chemistry, in this case LiCoO₂, requires the least weight regardless of vehicle class. As a result, a single battery chemistry can be used in a wide range of EVs. The implications of this on the business model will be discussed later in this brief.

Table B-1: Battery Weights for Various Vehicle-chemistry Combinations

				
	Type	Sports	Sedan	SUV
	LiFePO4	230 kg	303 kg	422 kg
	LiMn2O4	267 kg	351 kg	489 kg
	LiCoO2	197 kg	261 kg	361 kg

The next section adds cost to this model. The authors note that given further constraints on battery size (i.e., due to safety or battery swapping issues) the weight model can be further refined using the battery usage model presented in Section 1.2 of the Appendix.

2. Battery Manufacturing Cost Analysis

Li-ion battery costs are impacted by a variety of factors such as cell size and the quantity of materials, as well as battery design and the manufacturing process. The USABC target price for Li-ion batteries is \$3,500 for EVs to gain market acceptance (although as mentioned previously, depending on the business models in the ecosystem, higher prices may be acceptable). Regardless of the metrics used, low cost is a primary consideration in battery selection. Below the authors focus on the component costs of a typical cell using research on the market and existing manufacturing processes.

Raw materials costs are estimated to account for 75% of the cost of a battery.¹² Lithium itself makes up only about 3% of a battery by weight, either as salt in the electrolyte or incorporated into the cathode material.¹³ This means that costs of other materials, most importantly the cathode, will dominate the raw materials and manufacturing costs. Since production process details are proprietary and constitute a relatively small portion of total battery manufacturing costs, this section will focus on differences in materials costs for the three selected battery chemistries.

As mentioned above, the authors assume a graphitic carbon anode and consider cathodes consisting of lithium manganese oxide spinel (LiMn2O4, or LMO), lithium iron phosphate (LiFePO4, or LFP), or lithium cobalt oxide (LiCoO2, or LCO). Other raw materials include the electrolyte and separator material. Raw material costs for batteries center on supply of sources and the volatility of the commodities market. The cost figures used in this paper are based on the most recent average cost of

materials as of April 2009. Figure B-1 outlines a representative cost breakdown of the components in a Li-ion cell (LiMn₂O₄).¹⁴

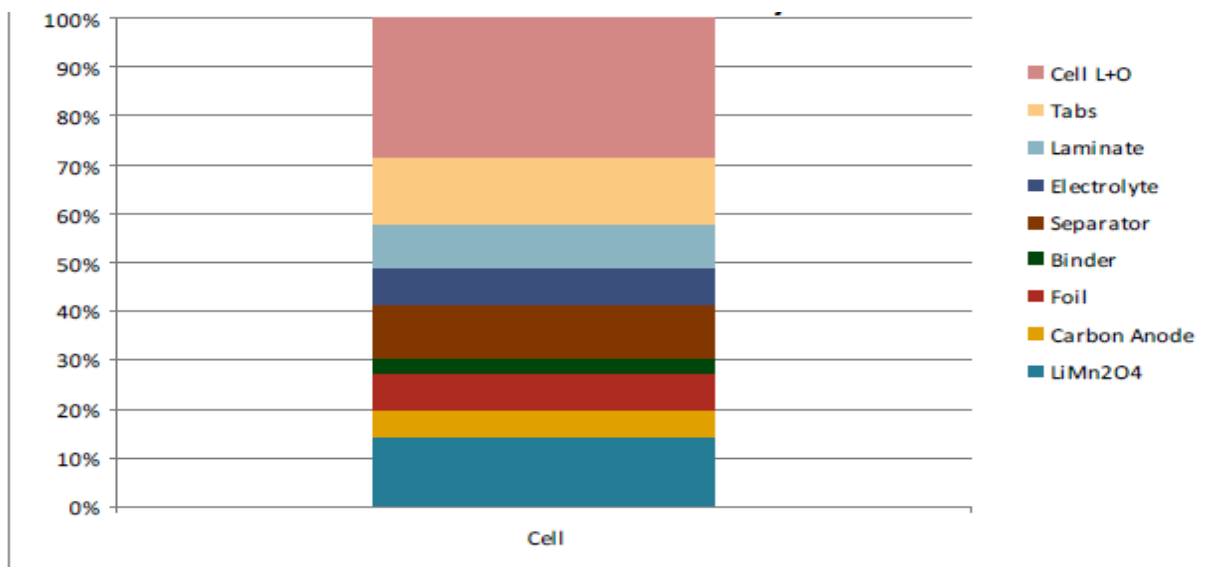

Figure B-1: Cost teardown of a typical lithium-ion cell.

Battery cells are constructed by rolling thin layers of cathode, separator, and anode material to cylindrical or stacked shapes. Liquid electrode makes up the internal space (Figure B-2). The battery cells are then placed as groups of 6-12 into modules and finally into packs based on size.

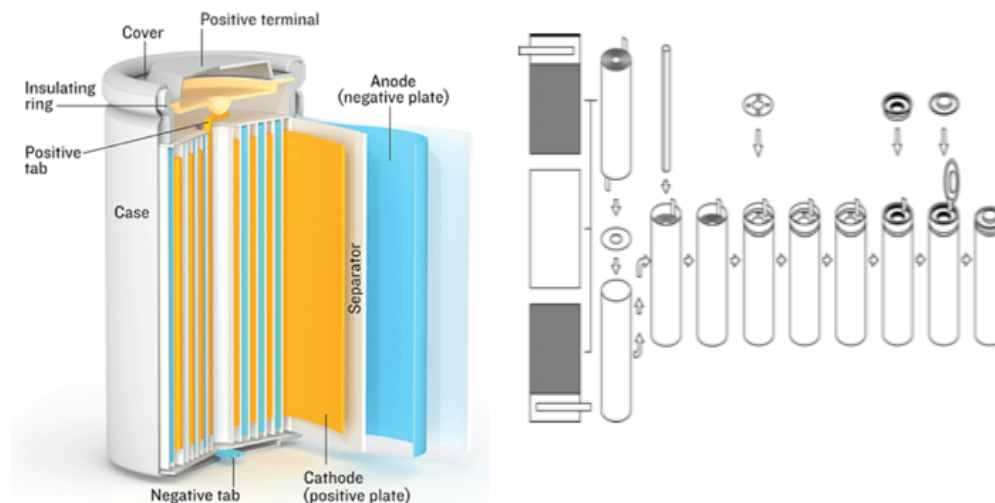

Figure B-2: Components and assembly of Li-ion cells.¹⁵

Each step in making and assembling the battery components requires additional manufacturing cost (although future advances may reduce manufacturing cost for Li-ion batteries). Below is a summary of the materials and production costs for components (see Appendix Table X-5 for details).

CATHODE: Cathode material is relatively expensive and drives performance. Table X-5 in the Appendix shows the range of materials cost for each metal material. To manufacture the cathode,

lithium ions are intercalated into the crystal structure of the metal oxide. NCO is produced by numerous companies, including BYD, Hitachi, Panasonic, and Sanyo. It is made by firing cobalt to form an oxide mix, to which lithium is added through chemical replacement reactions in a solution and then spray dried. LMO, produced by GS Yusa, LG Chem, NEC-Lamilion Energy, and Samsung, is made into a spinel structure, a 3D crystalline structure that increases surface area, which offers higher power at a lower cost than cobalt. The process involves pre-firing and then firing a mixture of Li salts with manganese oxide to 500 °C and then 900–1200 °C; the resulting product is powdered and then added to a crystal growth accelerator with lithium hydroxide or sulfide mixture and fired to 750–850 °C to form a metal spinel compound.¹⁶ LFP, produced by A123, Segway and Valence, is manufactured from an iron phosphate material. A123 uses a nanophosphate material for enhanced power.

ANODE: Graphite anode material is a common commodity and costs typically range from \$20/kg to \$40/kg.¹⁷ Manufacturing the anode requires baking the graphite at high temperatures on order of 1000 °C. Carbon and binder material in small amounts are needed to make the final anode.

SEPARATOR: The separator is made from polyethylene or polypropylene—an inexpensive material that costs under \$1.30/kg—into thin polymer films. The main costs arise from manufacturing the separator because it is thin, in the range of micrometers, and thus requires careful control. Developments are being made to reduce the cost of processes to obtain the polymer film at high volumes. Separators cost around \$120/kg to \$240/kg for materials 25µm thick with density of 1g/cm.^{18, 19} Recent trends show that the costs may be declining.

ELECTROLYTE: The electrolyte is another expensive material, around \$121/kg. However, the electrolyte is suspended in an inexpensive solvent, in which the total solution is 84.3% solvent by weight.²⁰ Production of the electrolyte mix involves mixing the solvent and obtaining sufficient purity and suspending the electrolyte. The production cost of mixing solvents to 98% purity is around \$28/kg. Premixed electrolyte from Merck ranges in cost from \$40–\$80/kg. The prices may drop as Li-ion technology becomes more widespread and/or advances are made in developing replacement material.

Other manufacturing costs include packaging, which is normally conducted in aluminum and/or plastic. The anode, separator, and cathode layers are packed into battery cases in an automated assembly line, filled with electrolyte, and then attached to safety devices and insulation. The control circuitry serves as another cost.

Table B-2 compares the costs for the battery chemistries chosen. There is a huge difference in cost between the chemistries, with LiCoO₂ by far the lowest. This is likely due more to historical reasons than the fundamental cost (e.g., due to materials). The LiCoO₂ batteries have enjoyed widespread use in battery packs for laptop and cell phone applications over the past decade, and hence are fabricated on a large scale. The large-scale production of these batteries has significantly driven down the cost per unit weight, compared to the other battery chemistries, which have yet to be implemented at large scale. This effect is very significant: LiCoO₂ uses cobalt, a comparatively expensive material (\$50 per kWh), yet these batteries sell for much less per kWh than LiFePO₄-based battery packs from A123 and Valence. Therefore, the prices shown must be carefully

considered in this context. If LiMn_2O_4 and LiFePO_4 can be produced in large quantities and thus take advantage of economies of scale, the price may be reduced significantly.

Table B-2: Battery Weights for Various Vehicle-chemistry Combinations







Chemistry Type	Cost of cathode element (\$/kg)	Fixed cost (\$) per kg of battery manufactured	Variable cost (\$) per kWh of cathode	Variable cost (\$) per kWh of battery	Specific energy of battery (kWh/kg)	Variable cost (\$) per kg of battery	Total cost (\$) of battery per kg
LiCoO_2	35.32 (Co)	10 (Good economy of scale)	65 [1]	195 (65*3)	0.175	34.125 (195*0.175)	44 [2]
LiMn_2O_4	2.33 (Mn)	55 (Low economy of scale)	5.50 [1]	38.5 (5.5*7)	0.08	3.08 (38.5*0.08)	58 [2]
LiFePO_4	0.50 (Fe)	146 (Negligible economy of scale)	1.50 [1]	10.5 (1.5*7)	0.108	1.134 (10.5*0.108)	147 [3]
Sources:							
[1] http://seekingalpha.com/user/290367/comments/symbol/abat							
[2] Cost of Li-ion battery for vehicles, US DOE							
[3] http://en.wikipedia.org/wiki/Lithium_iron_phosphate_battery							

Besides using different materials, the LiCoO_2 -based battery manufacturing is a mature, high volume process whereas LiFePO_4 -based battery manufacturing is not, as evidenced by the wide variation in A123's battery costs over the 2006 to 2008 timeframe. Based on data from A123's S-1 issued in August of 2008, battery costs per kWh were \$1,447, \$11,197, \$11,162 and \$1,505 for YE (Dec) '06, YE '07, Q1 (Mar) '07 and Q1 '08, respectively. Such oscillations in costs indicate a nascent, rather than a mature, manufacturing process. As these technologies progress along their experience curves and gain economies of scale, the authors expect they will become competitively priced compared to LiCoO_2 .

2.1. Summary of Battery Manufacturing Costs for Different Model Systems







In the previous section, the authors developed a matrix of vehicle types and battery chemistries, and derived the battery weight required for each of these systems. This data is now combined with the costs for each of the three chemistries in Table B-3.

Table B-3: Cost of Materials and Manufacturing for EV Batteries for Various Vehicle-chemistry Combinations

				
		Sports	Sedan	SUV
	LiFePO ₄	\$33,810 (230 kg* \$147/kg)	\$44,541 (303 kg* \$147/kg)	\$62,034 (422 kg* \$147/kg)
	LiMn ₂ O ₄	\$15,486 (267 kg* \$58/kg)	\$20,358 (351 kg* \$58/kg)	\$28,362 (489 kg* \$58/kg)
	LiCoO ₂	\$8668 (197 kg* \$44/kg)	\$11,484 (261 kg* \$44/kg)	\$15,884 (361 kg* \$44/kg)

Although the values in Table B-3 are based on estimates and may well be inaccurate, the relative values demonstrate some interesting points. Table B-4 presents normalized costs. Observe that the cost associated with an increase in battery weight required for large vehicles such as SUVs may make such vehicles prohibitively expensive. Also, LiCoO₂ requires by far the least fixed cost regardless of vehicle type. However, this point is intimately tied with economies of scale issues, as will be discussed below.

Table B-4: Normalized Costs from Table B-3

				
		Sports	Sedan	SUV
	LiFePO ₄ (A123)	3.90	5.02	7.16
	LiMn ₂ O ₄ (LG – Volt)	1.78	2.35	3.27
	LiCoO ₂ (Tesla)	1.00	1.32	1.83

2.2. Use Phase Costs Analysis

In this section, the authors find the cost during use for each battery chemistry-vehicle type combination. We assume that the total cost is comprised of delivering electrical power from the grid (charging) and the cost (if any) associated with swapping the battery. The cost equation is given by:

$$Cost_{use} \left[\frac{\$}{mile} \right] = \frac{Energy[kWh]}{trip[mile]} \times Cost_{electricity} \left[\frac{\$}{kWh} \right]_{1,2} + Cost_{swap} + Cost_{C.S.} \quad (1)$$

The first term in the above equation represents the amount of energy (average) per mile for a given trip. By using the battery weight model discussed previously and found in the Appendix, the total energy per trip can be readily determined. The second term is the cost rate for charging the battery given in dollars per kWh. This is the direct cost from the power utilities companies, and is separated into two components: a) current energy generation methods (e.g. electric companies) and b) renewable sources such as wind and solar. The third and fourth terms are costs associated with the battery swapping and infrastructure costs associated with the charge station, respectively.

To simplify the analysis, it is assumed that the costs associated with the battery swap and charge station are transparent to the consumer or are negligible compared to charging the battery. This means that the analysis performed is for the original battery pack (does not get replaced), which will follow a distinct State of Charge (SOC) curve over its cycle-life. Also, due to the availability of the data, the cost of electricity will be given by current charging rates, in particular from California's Pacific Gas & Electric (PG&E). These simplifications are acceptable because the goal is to compare the cost of the different battery technologies relative to each other rather than determine the absolute lowest cost.

The naïve approach in determining the total usage cost is to take the product of the first two terms in Equation 1. This approach overlooks a very important fundamental property of lithium-ion batteries: namely the SOC or energy capacity as a function of time/use. The total amount of charge or energy a battery can hold will decrease as the battery is charged and discharged (one cycle). This means that over time the maximum energy that the battery can hold will decrease from its original (i.e., new) state. The period length of time for this degradation is given by the battery's cycle-life for a given SOC; in general, the longer the cycle-life, the lower the degradation. Physically, when the battery degrades, the internal resistance, R , of the battery increases. The increase in the internal resistance causes more energy to be dissipated as heat (i.e., wasted), thus reducing the effective capacity of the battery even though it is charged with the same amount of power as a new battery.

The battery can be modeled as an equivalent resistor connected to a constant voltage source shown in Figure B-3.

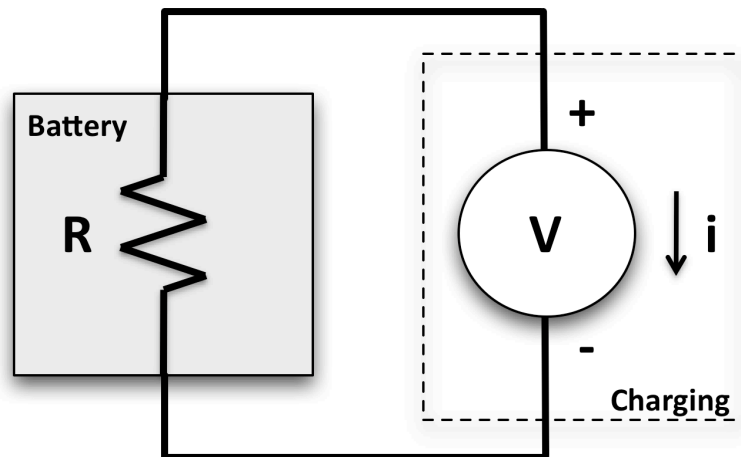

Figure B-3: Battery equivalent circuit.

Therefore, according to Ohm's Law, if the voltage, V , supplied (from the charging station) is constant then the current is scaled by V/R . The energy is computed by taking the time integral of the power, which is the product of the current, i , and the voltage, V . After imposing Ohm's Law, the energy equation is given by:

$$E_{battery} = \int P(t)dt = \int i(t)Vdt = \frac{V^2}{R}t \quad (2)$$

Equation 2 says that the energy of the battery is inversely proportional to the internal resistance; in other words, if the internal resistance increases, the energy of the battery decreases. This phenomenon must be taken into account when determining the cost of the use phase.

To determine the impact of the battery degradation on the cost of use, the SOC vs. cycle-life curves can be utilized. The SOC vs. cycle-life curves show, for a particular battery technology, the percentage of the original energy/charge capacity as a function of cycle use (i.e. charge, then discharge). Figure B-4 shows the SOC vs. cycle-life for an A123 LiFePO₄ battery. As shown in the figure, the discharge capacity decreases approximately linearly with the cycle number. If the SOC criterion is set at 80%, then this particular battery can last roughly 7,000 cycles.

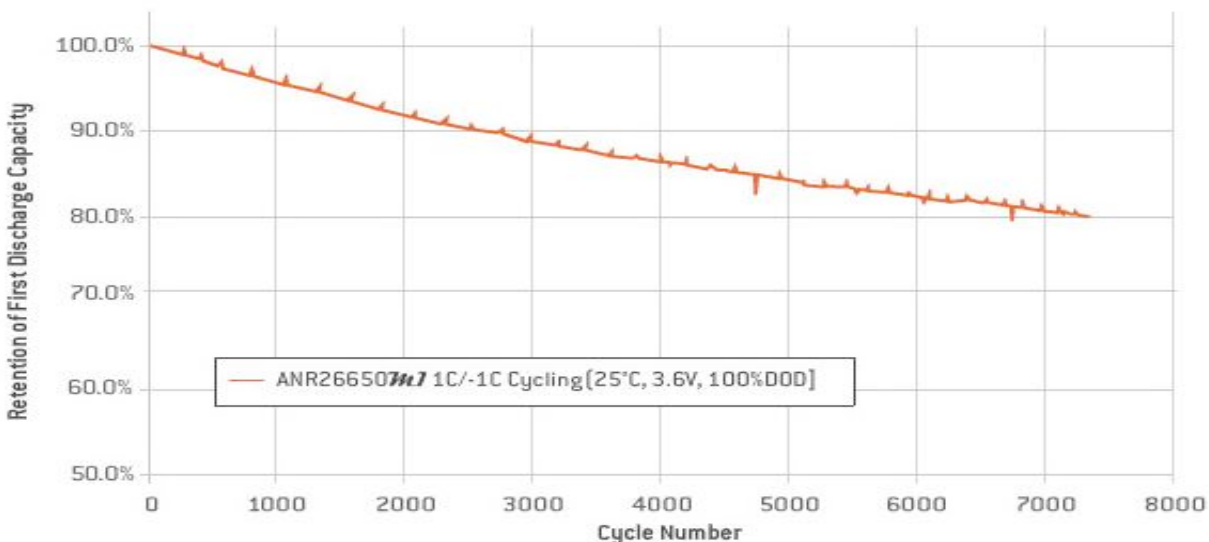

Figure B-4: SOC vs. cycle number for A123's use of nanophosphate technology.²¹

A summary of the cycle-life at 80% SOC can be found in Table B-5. To assess which battery has the lowest usage cost, the SOC efficiency, ϵ_{SOC} , will be defined as the ratio of the actual SOC to the theoretical SOC (100% at all cycles), which is shown in the equation below:

$$\epsilon_{SOC} = \frac{\int_0^{\tau@80\%} SOC(t) dt}{\tau@80\%} \quad (3)$$

Where, $\tau@80\%$ represents the cycle number when the SOC decays to 80%. To make use of Equation 3, the SOC will be approximated as a linear function of the cycle. In addition, the cycle number will be normalized to 1,000 cycles as recommended by the USABC (see Figure A-4) for Li-ion batteries in EVs.²² Since the 1,000 cycles recommendation exceeds the $\tau@80\%$ for the LiCoPO₄, the SOC will be linearly interpolated to the 1,000 cycle number as shown in Figure A-2. The results from Equation 3 are also shown in Table B-5, and represented graphically in Figure B-5.

Table B-5: Reported Cycle-life for Three Chemistries

Battery	Cycles (@80% SOC)	ϵ_{SOC}	Source
LiFePO ₄ (A123)	7000*	0.986	[1]
LiMn ₂ O ₄ (LG – Volt)	2800**	0.964	[2]
LiCoO ₂ (Tesla)	420**	0.762	[2]
Power Density (W/L)	5800	NA	
Sources:			
[1] www.a123systems.com			
[2] http://www.greencarcongress.com/2009/03/profile-li-ion-battery-and-pack-supplier-valence-technology.html#more			
[3] www.teslamotors.com , estimated			

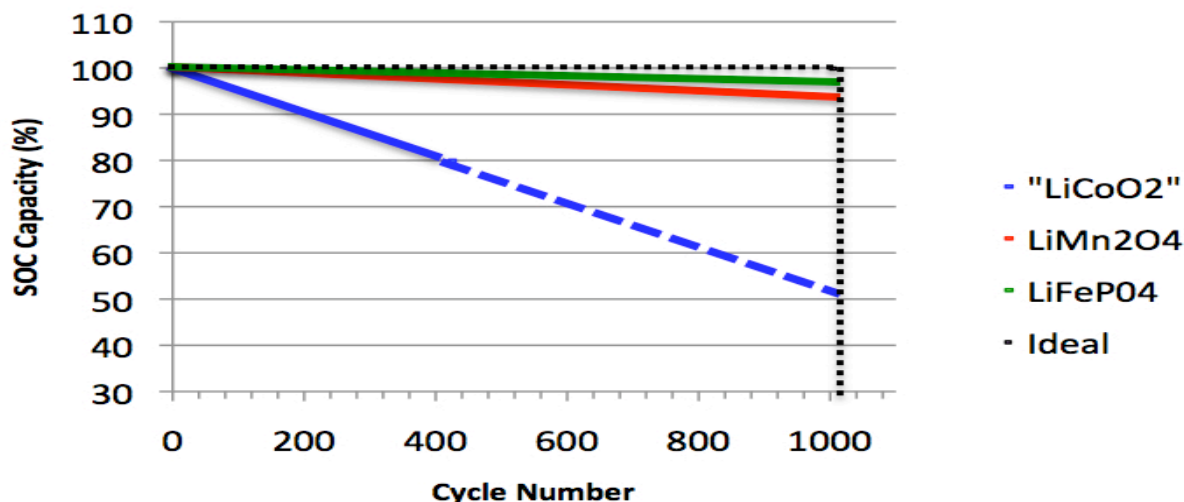

Figure B-5: SOC Capacity vs. cycle number for the different battery technologies shown up to 1,000 cycles.

The cost of usage Equation 1 can now be written as:

$$Cost_{use} \left[\frac{\$}{mile} \right] = \frac{1}{\epsilon_{SOC}} \times \left(\frac{Energy[kWh]}{trip[mile]} \times Cost_{electricity} \left[\frac{\$}{kWh} \right] \right) \quad (4)$$

The cost here is simply the product of electrical energy consumption of an ideal battery and the inverse of the SOC efficiency. As mentioned previously, the cost of electricity is taken from PG&E electric rates, and for residential services for March 2009 the cost is approximately \$0.115/kWh (on average). Using the electricity cost rate, the data from Table B-5, and the energy output from the Battery Weight Model, the results for the usage cost can be computed and normalized by the lowest cost as shown in Table B-6 for the different car and battery types (since the energy changes with car type).

Table B-6: Results of Usage Cost for All Three Battery Technologies and Car Types

Battery	Car	Sports	Sedan	SUV
LiFePO ₄ (A123) [ratio \$/mile]		1 \$0.029	1.32 \$0.038	1.83 \$0.053
LiMn ₂ O ₄ (LG-Volt) [ratio \$/mile]		1.04 \$0.03	1.37 \$0.04	1.91 \$0.055
LiCoO ₂ (Tesla) [ratio \$/mile]		1.27 \$0.037	1.67 \$0.048	2.33 \$0.068

The upper number represents the normalization from the close cost (sports with LiFePO₄).

The results show that the mass of the car plays a direct role in the usage cost. This makes sense because more energy is required to move a heavier car. The results also show a large cost difference with LiCoO₂, which is attributed to the low cycle-life. An interesting outcome is that the cost difference between LiFePO₄ and LiMn₂O₄ is only about 4% while the cycle-life differs by more than

50%. This suggests that both the LiFePO₄ (A123) and the LiMn₂O₄ (LG-Volt) have a cycle-life much longer than the usefulness of the car (from the consumer's perspective) as recommended by the USABC. Note, if the cost normalization was in respect to the battery life (of interest to, say, the battery owner), then the results should scale by the cycle-life.

The results of the analysis displayed in Table B-6 account for capacity loss on cycling as the only mechanism of performance degradation. This assumption is not entirely realistic, because Li-ion batteries can lose the ability to hold energy while stored in a state of rest. The amount of capacity lost during storage depends strongly on temperature and the state-of-charge at which the battery is stored. Data for Sony LiCoO₂ 18650 cells show that batteries stored at complete discharge may not lose any capacity, while those stored at complete charge at 40 °C can lose up to 30% of capacity in a year.²³ This suggests that calendar life, not cycle-life, may limit the usefulness of the car battery. Drawing quantitative conclusions about the lifetime of the battery is difficult because capacity fade is one of the least well-understood mechanisms in battery research.²⁴ Furthermore, newer materials, such as LiFePO₄, have not existed long enough for extensive data on calendar life to be published. However, the trends between cathode materials, in which LiFePO₄ is a longer-lived material than LiCoO₂ or LiMn₂O₄, should still apply.

3. Cost-based Selection Criteria for Choice

LiCoO₂ is a more affordable option now because of its high production volume relative to LiFePO₄, but with increasing production, manufacturing cost will lower dramatically. Ultimately, LiFePO₄ may be cheaper for high volume. See the Appendix for additional detail.

3.1. Battery Chemistry Selection Criteria from a Customer Perspective

The total cost (from the consumer's perspective) of the battery can be viewed as the manufacturing cost (initial cost for the battery) plus the electrical cost from the power grid. Any costs associated with communicating to the charging station and swapping are assumed to be transparent to the consumer, as noted in the previous section. Figure B-6 plots the total costs of the different battery technologies as a function of distance (i.e., miles).

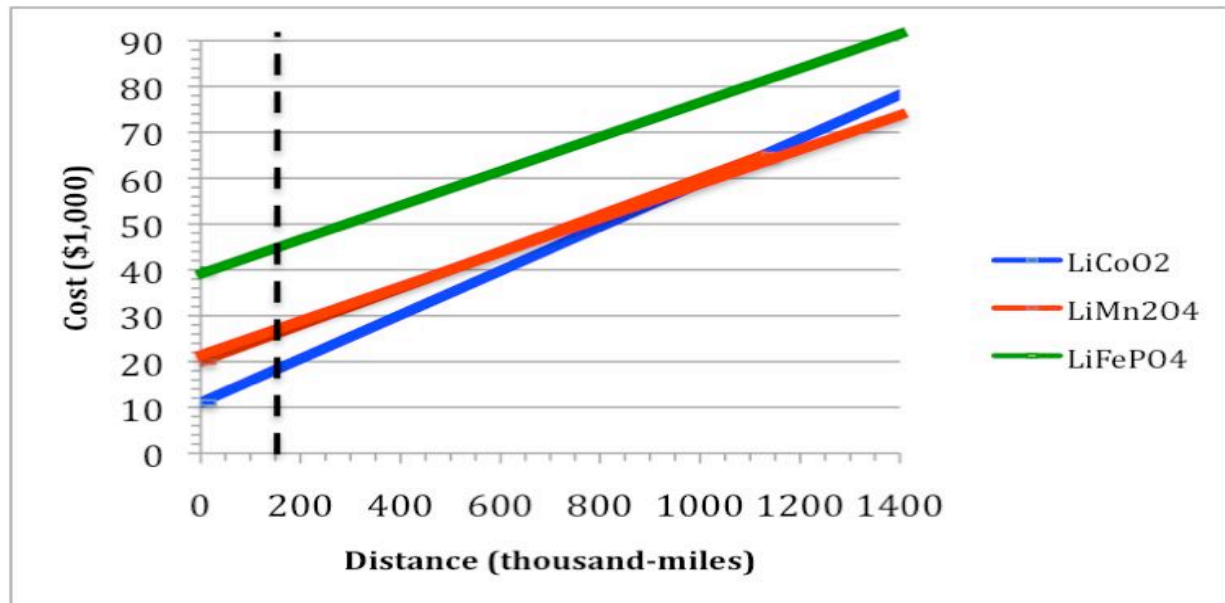

Figure B-6: Total cost vs. distance traveled. The higher usage cost of the LiCoO₂ (blue line) eventually becomes the highest total cost. The black dashed line represents the life mileage of a typical car.

The lower cycle-life of LiCoO₂ directly affects the total cost and at some mileage will have the highest cost-of-ownership (COO). However, a typical lifespan of a car in general is usually no more than 150,000 miles due to issues such as motor failure, and mechanical/electrical issues. This is represented in Figure B-6 as the vertical black dotted line. At this point the cost is mainly dominated by manufacturing because the relative cost ratios between the three are higher for manufacturing than for usage. Therefore, it turns out that even though LiCoO₂ has a higher usage cost, its total cost during a typical car lifespan is lower.

It is worth noting that battery recycling was not taken into account. Batteries with a higher cycle-life can be reused longer either in a new car or as a storage system on the grid. Those associated costs will need to be integrated into the model to provide a more accurate cost analysis.

4. Electricity Cost Considerations

Up until now most of the costs associated with the battery cell and scrutinized by the authors have been from a materials standpoint. However, it is useful to understand the manufacturing cost of not only the direct costs such as raw materials, but also the indirect costs, like utilities and labor, in producing a Li-ion battery cell. This section focuses on the indirect costs, in particular the electricity costs from mining and extracting the raw materials to processing the components such as the cathode and anode to eventually the cell itself. Figure B-7 below shows the hierarchy for the manufacturing teardown that is used for the analysis.

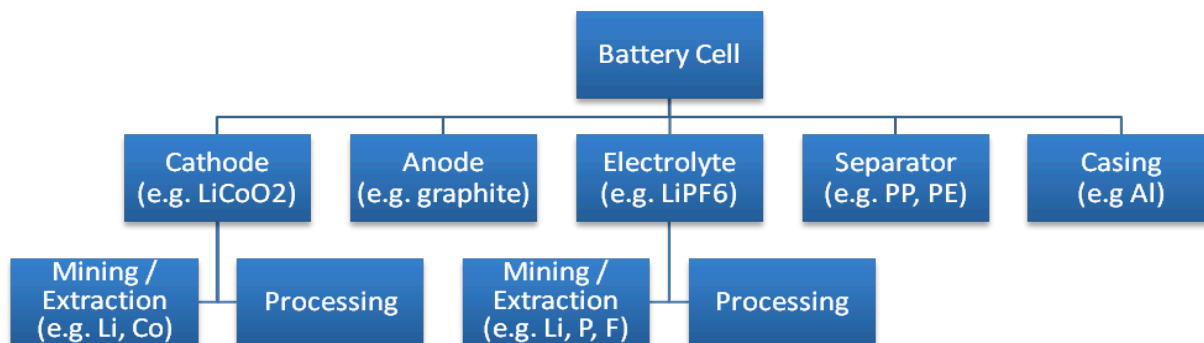

Figure B-7: Battery cell hierarchy for electricity usage contribution to total cost.

The analysis focused on the major components (from a cost and weight perspective), each broken down into a Mining/Extraction phase and Processing phase with the cathode and electrolyte having direct sectors due to the complexity of the compound. The total electricity use is computed by summing the individual electricity consumption of each stage in Figure B-7. For example, the electricity consumption of mining lithium, cobalt, iron, etc. is added to the consumption of processing LiCoO₂, which is added to the consumption of manufacturing the entire cell.

The electricity consumption data for each stage in Figure B-7 was not readily available. In order to overcome this, a cost analysis for manufacturing a Li-ion cell was performed and then combined with the electricity data of different industry sectors from the Economic Input-Output Life Cycle Assessment (EIO-LCA) tool provided by Carnegie Mellon.²⁵ Figure B-8 shows the cost teardown between an 18650 cell LiCoO₂ and LiFePO₄ cathode-type battery with similar performances. This teardown is not to be confused with the data in Section 2 since costs can vary widely depending on cell type, form factor and manufacturer.

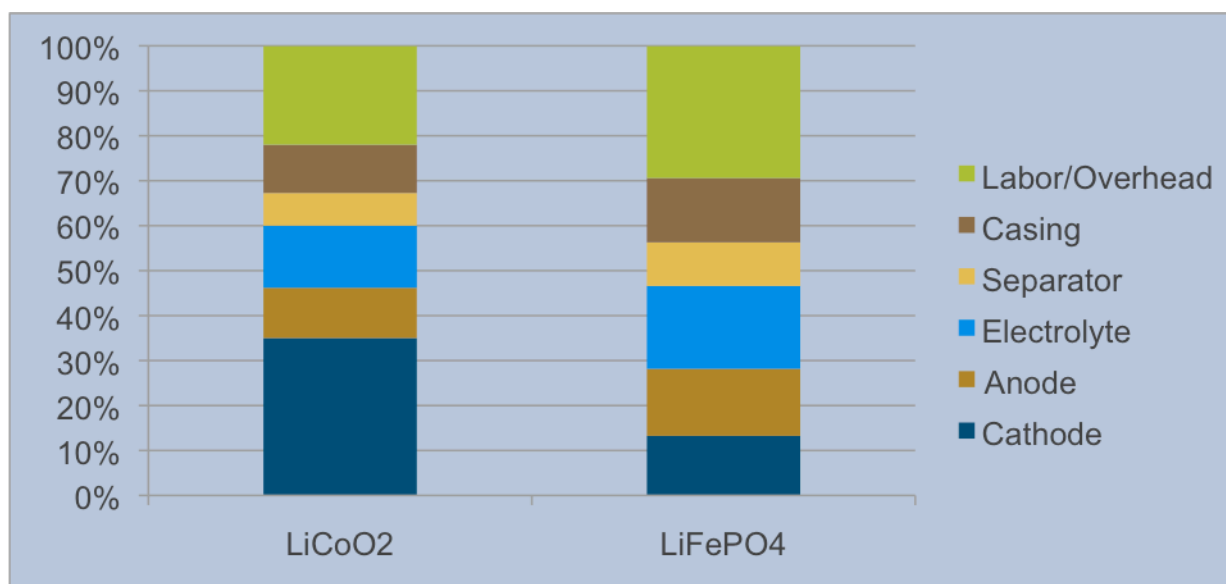

Figure B-8: Cell cost teardown of the major components.

The electricity data from EIO-LCA outputs the energy use for an industry sector in terms of kilowatt-hours per economic activity in 1997, which is summarized in Table X-4 in the Appendix. The electricity usage is therefore the product of the component cost, electrical energy per dollar and an inflation factor; the inflation factor is simply to convert 1997 dollars into 2006 dollars (the year of which the cost data was obtained). The entire relationship is expressed in Equation 5 below:

$$Power_{component} (kWh) = Cost_{component} (\$) \times Power_{industry} \left(\frac{kWh}{\$} \right) \times \frac{Dollar_{1997}}{Dollar_{2006}} \quad (5)$$

The cost of the components is straightforward for non-complex materials such as the anode and casing (assumed to be of a single element such as graphite). However, for compound materials such as the cathode, which is comprised of lithium and other compounds, the contribution of the cost must further be broken down to retrieve the energy impact for each element. To accomplish this, the EIO-LCA tool was used to output the total economic activity (in 1997 \$U.S.) for each element's industry sector. Once the economic activity for each element was obtained, in addition with the weight percentage of the element to component, the cost contribution for the element was realized. Using the LiCoO₂ cathode as an example, the economic activity for lithium (per Table X-4 in the Appendix) for every \$1.00M spent, \$1.87M is stimulated. Likewise for cobalt, \$2.07M is stimulated for every \$1.00M spent. The weight contribution of lithium (7g/mol) to LiCoO₂ (99g/mol) is 7.07%; therefore, the cost of just lithium in LiCoO₂ is simply:

$$C_{Li} = \frac{1.87M\$}{1.87M\$ + 2 \cdot 2.07M\$} \times \frac{7 \text{ g/mol}}{99 \text{ g/mol}} \times C_{LiCoO_2} = 0.022 \cdot C_{LiCoO_2}$$

A similar calculation was conducted with cobalt and with the LiFePO₄ cathode and the electrolyte. The cost data for the major components can be found in Table X-5 in the Appendix. It was assumed that oxidation (oxygen atoms) had no cost except for during processing. The results of the electricity usages for the two battery types in terms of percent total are shown in Figure B-9 below.

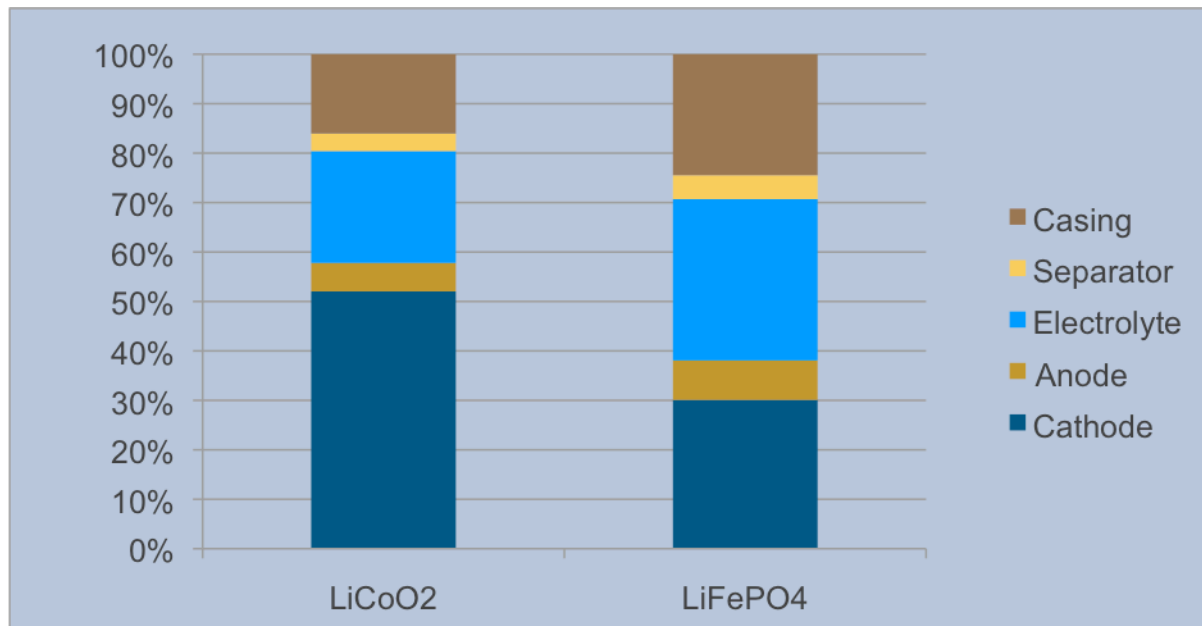

Figure B-9: Electricity usage for mining and processing the different components of the cell.

For LiCoO₂ the cathode represents the largest electrical energy consumption for the cell followed by the electrolyte. The LiFePO₄-based cell has much lower electrical energy consumption for the cathode primarily due to the lower cost of the material.

The contribution of the electricity cost to total cell cost can be determined by taking the product of the energy results conducted above and the cost of electricity supplied by the power utilities (usually in \$/kWh). Figure B-10 displays the results of the two battery types along with three different regions: California, U.S., Michigan, U.S., and China. The price per kWh can be found in Table X-3 in the Appendix.

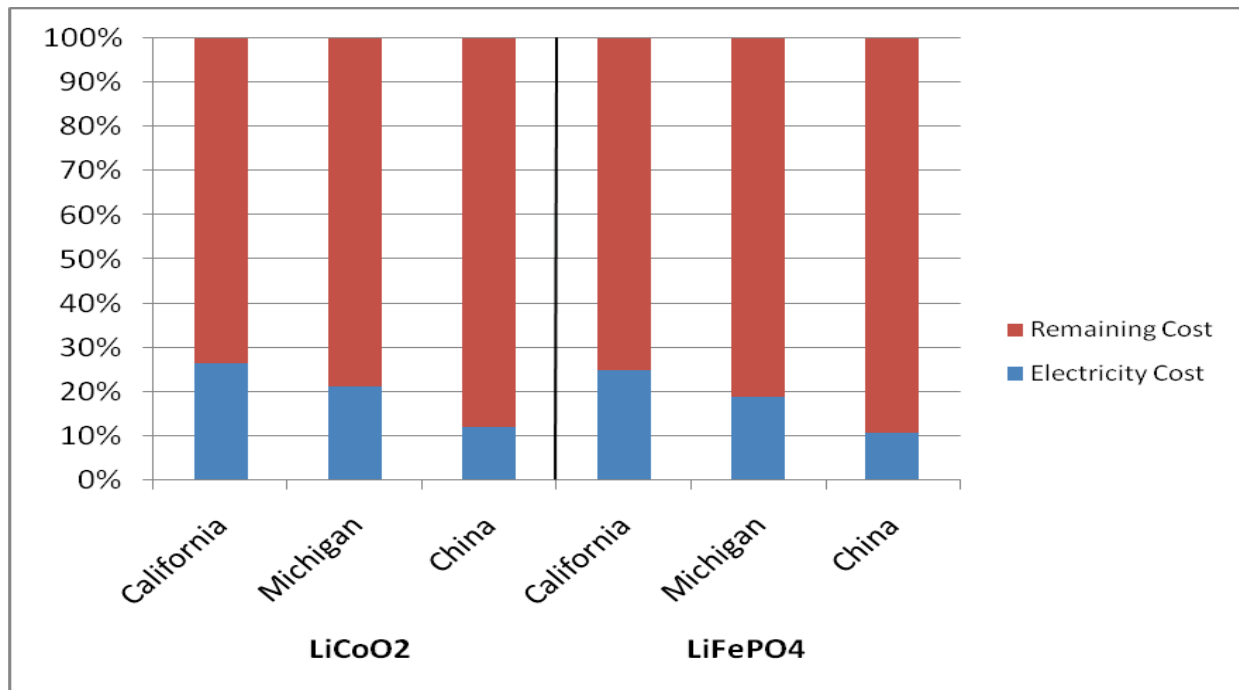

Figure B-10: Electricity cost as percentage total cell cost for LiCoO₂ and LiFePO₄.

As seen in Figure B-10, electricity contributes to a large percentage of total cost (roughly a quarter of the total cost (U.S. average)). For example, the electricity cost per kWh in China is roughly 2.5x lower than California. If everything (materials, labor, etc.) is set equal, this translates to an 83.3% cost reduction ($(100\% - 25\%) / (100\% - 10\%) = 0.833$) just by manufacturing in China (assumed materials are mined in China and transportation costs are ignored).

Conversely, the cell cost holds opportunity for reducing electricity costs. For example, optimizing the mining and production process and/or using renewable sources to consume 50% less energy translates to 12.5%, 10.0%, 5.0% cost reductions for California, Michigan, and China, respectively. This incentivizes investments in optimizing the battery cell manufacturing process in the U.S. in order to reap significant cost savings in terms of electricity. Also, between the two battery technologies, the electricity cost percentage did not change by much. This can be due to the assumptions and limitation in data as well as the fact that the bulk of the cell is more or less similar regardless of the cathode technology (e.g., casing, metal connects).

There are also environmental benefits for producing locally (California produces cleaner energy and much of the energy production in China comes from coal) that will be explored in the next section. Keep in mind that all of the above analysis did not account for the small components in the cell such as tabs, copper foil and electrical circuitry, which will lead to an even larger energy cost contribution. Also electrical cost due to overhead such as computers and lighting were not considered and would further increase the contribution.

Part C: Environmental Impact Assessment for Batteries Manufacture

A carbon footprint is a measure of the exclusive amount of carbon dioxide (CO₂), usually in kilograms or tons, and other greenhouse gases emitted by a human activity or accumulated over the full life cycle of a product or service. The life cycle concept of the carbon footprint means that it is all encompassing and includes all possible causes that give rise to carbon emissions. In other words, all direct (on-site, internal) and indirect emissions (off-site, external, embodied, upstream and downstream) need to be taken into account. In this respect, it is appropriate to define the Global Warming Potential (GWP) of a gas 'x' as the potential to contribute to the global warming change as measured on a per-molecule basis and defined approximately as in equation below:

$$\text{GWP} = \frac{\text{Time integrated radiative absorption due to 'x'}}{\text{Time integrated radiative absorption due to CO}_2}$$

Carbon footprints can be calculated using a Life Cycle Assessment (LCA) method, or can be restricted to the immediately attributable emissions from energy use of fossil fuels. The term life cycle in LCA refers to the notion that a fair, holistic assessment requires the assessment of raw material production, manufacture, distribution, use and disposal, including all intervening transportation steps necessary or caused by the product's existence. The sum of all those steps or phases consists of the life cycle of the product.

The goal of a LCA is to compare the full range of environmental damages assignable to products and services, and choose the least burdensome. The concept also can be used to optimize the environmental performance of a single product (eco-design) or to optimize the environmental performance of an office setting. Common categories of assessed damages are global warming (greenhouse gases), acidification, smog, ozone layer depletion, eutrophication, eco-toxicological and human-toxicological pollutants, desertification, land use, and the depletion of minerals and fossil fuels.

Figure C-1 shows the environmental impact of the different industrial sectors involved in the manufacturing of a typical Li-ion cell, expressed in terms of relative percentages of the greenhouse gases emitted. It is clear from the figure that power generation and supply constitutes the major chunk of the environmental impact. The power consumed during the several stages of the manufacturing pipeline is produced from non-renewable and polluting sources like coal and petroleum, and hence has many emissions potentially associated with it. The use of clean renewable sources like wind and solar power will have a natural impact on the reduction of the emissions. The iron and steel sectors also influence the impact, as does transportation. Sustainable means of transportation employing cleaner fuels with zero exhaust levels can help further mitigate the overall environmental impact.

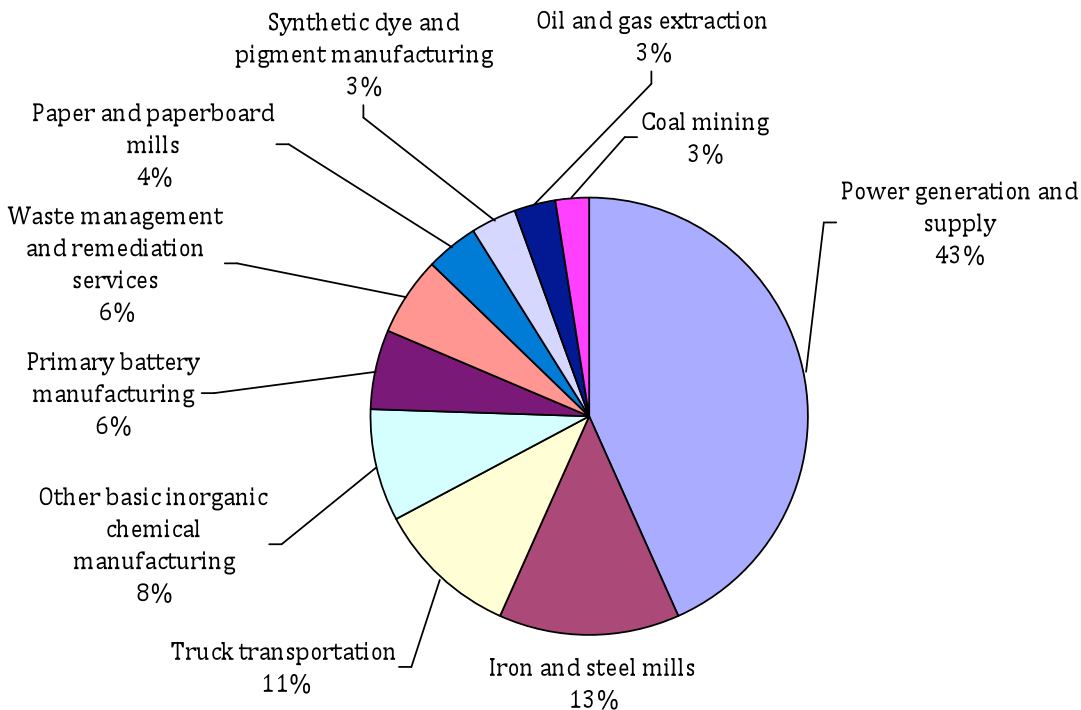

Figure C-1: Environmental impact of different industrial sectors involved in manufacturing a typical Li-ion cell

Figure C-2 shows the contribution of the different components of a LiMn_2O_4 cell towards the total manufacturing phase emissions. The methodology to calculate these contributions is based on the cost teardown information discussed in the previous section, and the previously mentioned EIO-LCA database from Carnegie Mellon. It can be seen that the cathode and electrolyte, which consist of Li compounds, constitute a total of 46% of the cell manufacturing emissions. There is thus a tremendous scope to ensure Li extraction, processing and compound manufacture is accomplished in a greener way, mitigating the environmental impact of producing these batteries.

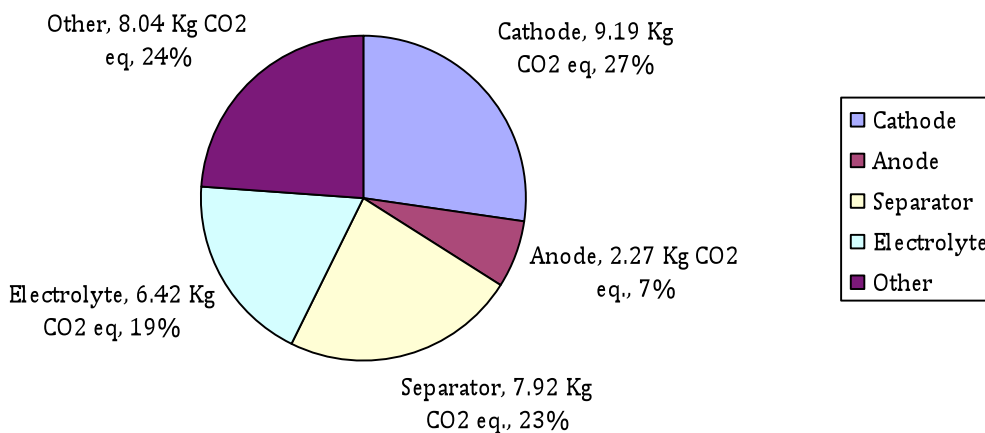

Figure C-2: Contribution of different cell components toward total manufacturing phase emissions

Part D: Additional Considerations for EV Battery Manufacture

1. Raw Materials and Potential Supply Issues²⁶

Li-ion batteries have emerged as the clear front-runner in the EV battery race. While there are several different chemistries, the key Li-ion raw materials are lithium, cobalt, nickel, and manganese. For EVs to be successful, battery makers must be certain that these materials are rich in supply and are accessible both physically and politically.

Lithium: Contrary to some reports, there is an abundant lithium supply and shortages are unlikely. Using a conservative estimate, there are 4.1 million tons of lithium reserves in the world (some estimates are as high as 13 million tons). This quantity is enough lithium to supply 1.3 billion EVs. For reference, the total global vehicle population is approximately 800-900 million;²⁷ hence, there is plenty of lithium available to power EVs worldwide.

In terms of lithium mining, the U.S. is not strong but could leverage partnerships to fill the void. Chile and Argentina are production leaders, while Bolivia has a massive amount of untapped reserves. China is also home to a significant portion of lithium mining activity. The United States has positive trade relationships with both Chile and Argentina, but Bolivia and China are problem spots. Bolivia has a poor trade relationship with the U.S. characterized by a history of political unrest and a tendency to nationalize natural resources. China has a contentious trade history with the U.S., but there have been recent incremental improvements.

Cobalt: Cobalt is a key yet contentious material due to its high cost. Congo (Kinshasa), Australia, Canada, and China are the leading producers of cobalt. While the U.S. historically has strong bilateral relationships with both Australia and Canada, Congo has a history of political turmoil and China's issues with the U.S. have already been mentioned above.

Nickel: Russia and Canada combine to produce about 70% of the world's supply of nickel. Australia and Indonesia are also major players. The U.S. enjoys strong trade relationships with Canada, Australia, and Indonesia, but Russia is a question mark. The U.S. and Russia have a checkered political and trade history. But recently there have been improvements in tariffs and trade restrictions and there is hope for continued progress.

Manganese: South Africa and the Ukraine are home to the majority of the world's identified manganese resources, accounting for 80% and 10% of the total world manganese production, respectively. This puts the U.S. in a dangerous position if manganese were to become the cathode material of choice. U.S. access to the mineral would virtually be in the hands of one country. Fortunately, the U.S. has a strong bilateral trade relationship with South Africa. But if things changed, the U.S. would be in a tough position and domestic EV battery makers would be left scrambling for the raw material.²⁸

2. Future Trends in the EV Battery Ecosystem

The dynamic nature of the EV ecosystem makes predicting even the near-term future difficult. Advances in energy density and cost are expected to continue at a linear rate (at least). In the past 10 years, energy density has doubled for Li-ion batteries, while cost has reduced by a factor of 10. In the U.S., large government investments in battery technology as well as the global energy crisis may drive improvements at an even faster rate.

These improvements may obviate the need for a large EV infrastructure. Currently, it is unclear how consumers will value EV range. If and when battery technology can meet the energy demands of most drivers, batteries will largely compete on the basis of cost. Once this occurs, the battery market may become largely commoditized. The question of the time scale for this to occur is uncertain, and relies on a broader range of ecosystem components than simply the battery technology itself. Nonetheless, given the current rate of innovation in battery performance and decreases in cost, commoditization may be reached in as little as 10 years.

Conclusions

- The U.S. Advanced Battery Consortium (USABC) developed a set of specification goals for electric vehicles. To date, current technology meets power requirements, but energy and cost are quite far from the target—the emphasis being on cost. Safety is also a concern as lithium is highly reactive and the solvent inside batteries is flammable.
- In terms of battery weight models, an SUV requires roughly 2x the battery weight of a smaller sedan or sports car, regardless of chemistry. This will lead to increases in cost. Also, a single chemistry (in the example given it is LiCoO_2) requires the least weight regardless of vehicle class. As a result, a single battery chemistry can be used in a wide range of EVs.
- The USABC target price for Li-ion batteries is \$3,500 for EVs to gain market acceptance.
- The raw materials costs of EV batteries are estimated to account for 75% of the cost of a battery. Lithium itself makes up only about 3% of a battery by weight, either as salt in the electrolyte or incorporated into the cathode material. This means that costs of other materials, most importantly the cathode, will dominate the raw materials and manufacturing costs.
- Besides using different materials, the LiCoO_2 -based battery manufacturing is a mature, high volume process whereas LiFePO_4 -based battery manufacturing is not.
- Data says that the energy of the battery is inversely proportional to the internal resistance; in other words, if the internal resistance increases, the energy of the battery decreases.
- The mass of a car plays a direct role in the usage cost, which makes sense because more energy is required to move a heavier car. Research results also show a large cost difference with LiCoO_2 is attributed to the low cycle-life. An interesting outcome is that the cost difference between LiFePO_4 and LiMn_2O_4 is only about 4% while the cycle-life differs by more than 50%. This suggests that both the LiFePO_4 (A123) and the LiMn_2O_4 (LG-Volt) have a cycle-life much longer than the usefulness of the car (from the consumer's perspective) as recommended by the USABC.
- The amount of capacity lost during storage depends strongly on temperature and the state-of-charge at which the battery is stored.
- The affordable processing of iron and manufacturing of LiFePO_4 can allow good economies of scale to lower the overall cost of battery manufacturing substantially, which in turn leads to reduced battery costs for the customer.
- Though LiCoO_2 has a higher usage cost, its total cost during a typical car lifespan is lower than other options.
- Electricity cost plays an enormous role in overall battery cost, and manufacturing batteries locally could yield significant economic gains. For example, the electricity cost per kWh in China is roughly 2.5x lower than California. If everything (materials, labor, etc.) is set equal, this translates to an 83.3% cost reduction $((100\%-25\%)/(100\%-10\%)=0.833)$ just by manufacturing in China (assumed materials are mined in China and transportation costs are ignored).
- The cell cost also has a great deal of headroom in terms of reducing electricity costs. For example, optimizing the mining and production process and/or using renewable sources to consume 50% less energy translates to 12.5%, 10.0%, 5.0% cost reductions for California, Michigan, and China,

respectfully. This incentivizes investments in optimizing the battery cell manufacturing process in the U.S. in order to reap significant cost savings in terms of electricity.

- By far, the largest environmental impact of batteries during the processing phase is the power generation (43%). There are environmental benefits for producing locally (California produces cleaner energy and much of the energy production in China comes from coal).
- The cathode and electrolyte, which consist of Li compounds, constitute a total of 46% of the cell manufacturing emissions. There is thus a tremendous incentive to ensure Li extraction, processing and compound manufacture is conducted in a greener way, mitigating the environmental impact of producing these batteries.
- While there are several different chemistries, the key Li-ion raw materials are lithium, cobalt, nickel, and manganese. For EVs to be successful, battery makers must be certain that these materials are rich in supply and are accessible both physically and politically.

References

1. **Ener1 Investor Presentation**, November 2008.
2. **Harrop, P.** “EV Market Forecast.” (June 6 2005) Available Online at: <http://www.evworld.com/article.cfm?storyid=860>
3. **UC Berkeley.** “Lithium Ion Batteries.” Lecture notes. <http://battery.berkeley.edu>. (October 18, 2007)
4. **Whittingham, M.S.** Chemical Reviews 104. 4271-4301. (2004)
5. **Ohzuku, T., Brodd, R.J.** Journal of Power Sources 174. 449-456. (2007)
6. **Ibid.**
7. **Ibid.**
8. **USABC FreedomCar.** “Electrochemical Energy Storage Roadmap.” (September 12, 2006) Available online at www1.eere.energy.gov/vehiclesandfuels/pdfs/program/electrochemical_energy_storage_roadmap.pdf.
9. **Merriman, Curhan, and Ford. Craig Irwin, VP.** “Energy Storage: CleanTech Industry Report.” (May 2008)
10. **Whittingham, M.S.** Chemical Reviews 104. 4271-4301. (2004)
11. **Wikipedia.** http://en.wikipedia.org/wiki/Regenerative_braking
12. **Argonne National Laboratory.** Costs of Lithium-Ion Batteries for Vehicles.
13. **Fisher, K., Wallen, E., Laenen, P. P., and Collins, M.** Battery Waste Management Life Cycle Assessment. www.defra.gov.uk/environment/waste/topics/batteries/pdf/erm-lcareport0610.pdf. (2006)
14. **Merriman, Curhan, and Ford. Craig Irwin, VP.** “Energy Storage: CleanTech Industry Report.” (May 2008)
15. **Hohsen Corp.** (1998)
16. **Manufacturing Method of Spinel Lithium Manganese Oxide for Lithium Secondary Cell.** United States Patent 6475455.
17. **Superior Graphite:** <http://www.superiorgraphite.com/>
18. **Whittingham, M.S.** Chemical Reviews 104. 4271-4301. (2004)
19. **Argonne National Laboratory.** Costs of Lithium-Ion Batteries for Vehicles.
20. **Ibid.**
21. **A123 Systems:** www.a123systems.com/technology/life (2009)
22. **USABC FreedomCar.** “Electrochemical Energy Storage Roadmap.” (September 12, 2006) Available online at www1.eere.energy.gov/vehiclesandfuels/pdfs/program/electrochemical_energy_storage_roadmap.pdf.
23. **Spotnitz, R.** J Power Sources 113(1) 72-80. (2003)
24. **Safari, M. et al.** J. Electrochemical Society 153(3) A145-A153. (2009)
25. **Carnegie Mellon University Green Design Institute.** Economic Input-Output Life Cycle Assessment (EIO-LCA), Industry Benchmark model [Internet], Available from: <http://www.eiolca.net>. (1997)
26. **U.S. Geological Survey.** “Commodity Statistics and Information.” <http://minerals.usgs.gov/minerals/pubs/commodity/>

- 27. CLSA Electric Vehicles Special Report.** “Lithium Nirvana, Powering the Car of Tomorrow.” (2008)
- 28. U.S. Department of State.** “Bureau of Public Affairs: Electronic Information and Publications Office.” <http://www.state.gov/r/pa/ei/bgn/>
- 29. A123 Systems.** www.a123systems.com/products (2009)
- 30. Carnegie Mellon University Green Design Institute.** Economic Input-Output Life Cycle Assessment (EIO-LCA), Industry Benchmark model [Internet], Available from: <http://www.eiolca.net>. (1997)
- 31. Howard W.F. and Spotnitz R.M.** Theoretical evaluation of high-energy lithium metal phosphate cathode materials in Li-ion batteries, *J. Power Sources*, 2007, 165 (2): 887.
- 32. Gaines, L. and R. Cuenca.** Costs of Lithium Ion Batteries for Vehicles, Argonne National Laboratory Report ANL/ESD-42, Argonne IL. (May, 1999)

Appendix

1. Technical Models

Part B addresses the primary question concerning this brief: given the current state of the ecosystem, what will the range of EV batteries look like in terms of weight and cost? To answer this question, the authors developed a detailed battery weight model. Using the chemistry specifications and market demands presented in the previous section, the battery weights required for each chemistry-vehicle combination was identified. The authors then estimated the fixed and use costs for each combination. A flowchart for this process is presented in Figure X-1.

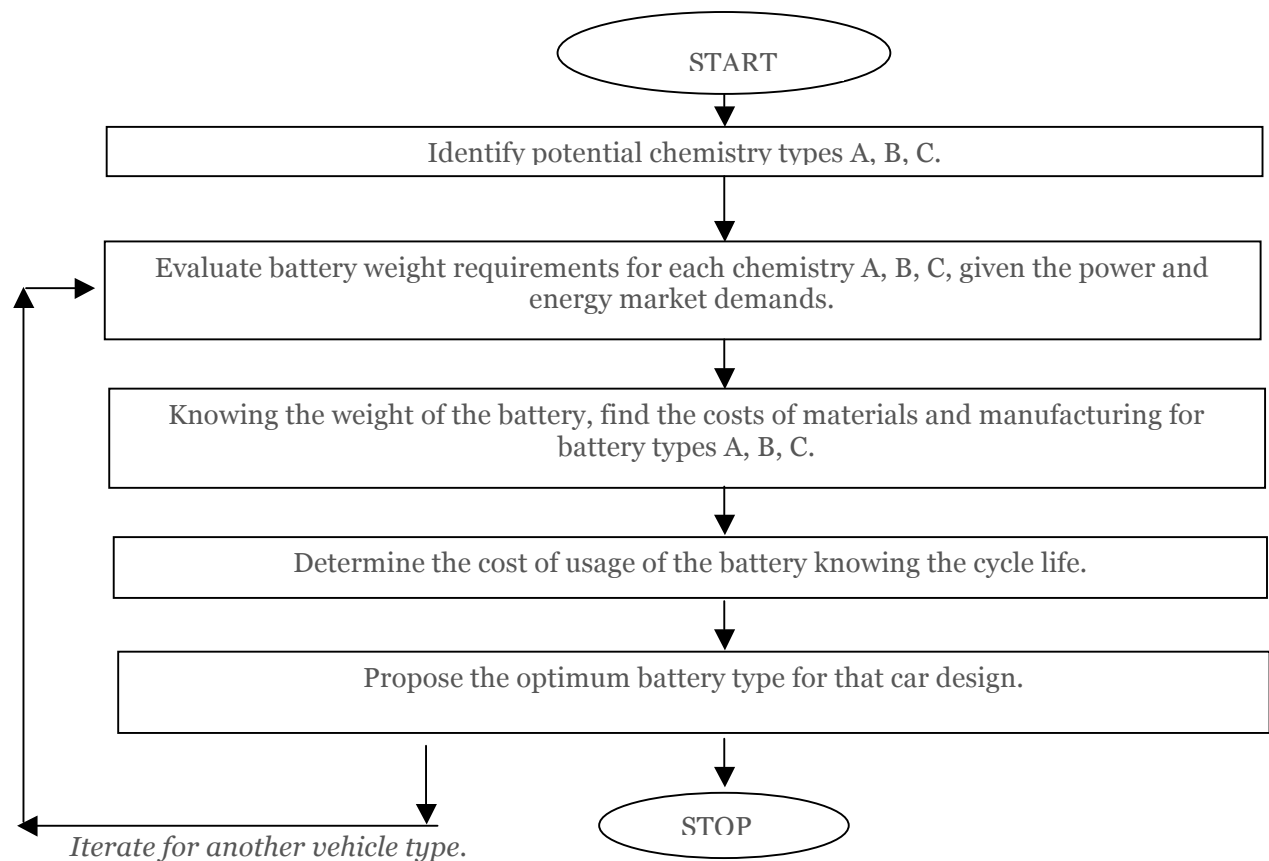

Figure X-1: Flowchart for the performance and cost models used in this section.

1.1. Battery Weight Model

We present the overview of a model which is used to compute the weight of the battery, given a set of inputs about the vehicle and ecosystem requirements.

Output:

- Weight of battery

Assumptions:

- Constant drag coefficient
- Constant acceleration and deceleration for flat streets, hill, and in traffic
- Constant coefficient of rolling friction
- Regenerative power is percent of energy restored during deceleration
- Landscape consists of multiple repetitive segmented distances

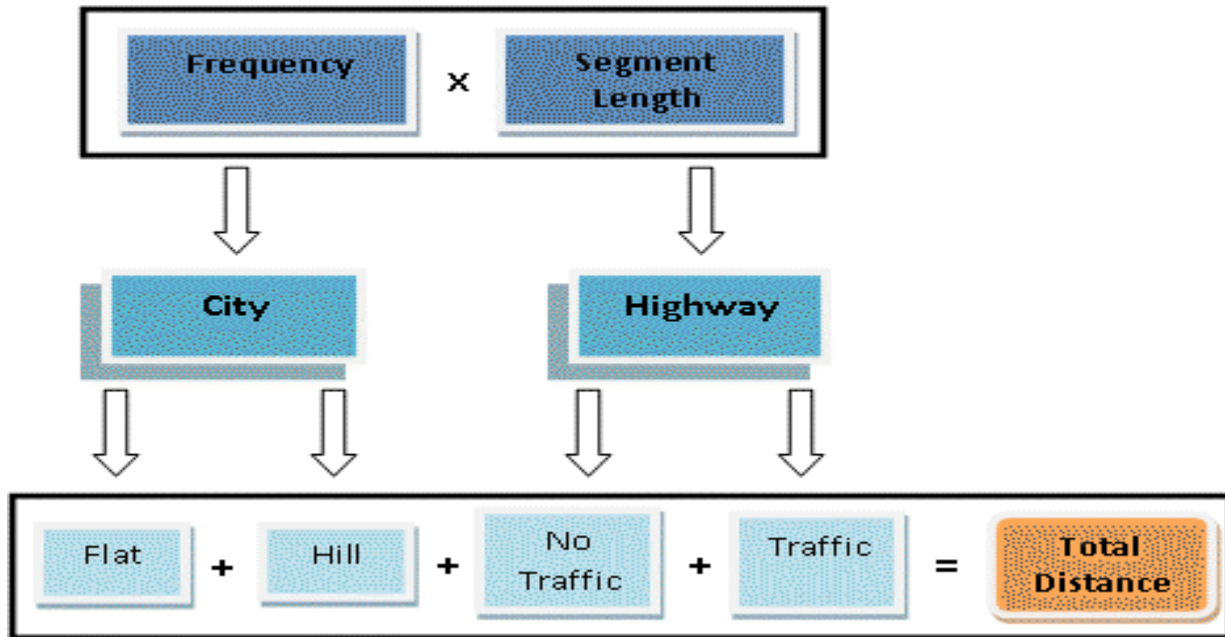

Figure X-2: Distance Diagram

Input Parameters:

- Drive Train Efficiency – Efficiency (from 0 to 1) of the drain train system and power delivery
- Regenerative Braking Efficiency – Power regenerated due to braking; from 0 to 1
- Frontal Area – Maximum frontal cross sectional area [m²]
- Car chassis mass – mass of car without battery [kg]
- Initial battery mass – a starting point for the mass iteration [kg]
- Drag coefficient – dictates the ratio of the air resistance that the car experiences; from 0 to 1
- Misc. electronics power – radio, AC, power steering, etc... [watt]
- 0-60 time – acceleration under normal driving conditions [m/s²]
- Segment Length – distance of a unit driving segment (e.g. street-light to street-light) [m]
- Frequency – number of occurrences of the segment length
- Speed Limit – driving speed for a segment length [m/s]

- Speed Multiplier - actual speed; multiplier
- Head Wind – speed of oncoming wind [m/s]
- Grade – inclination of hill [degrees]

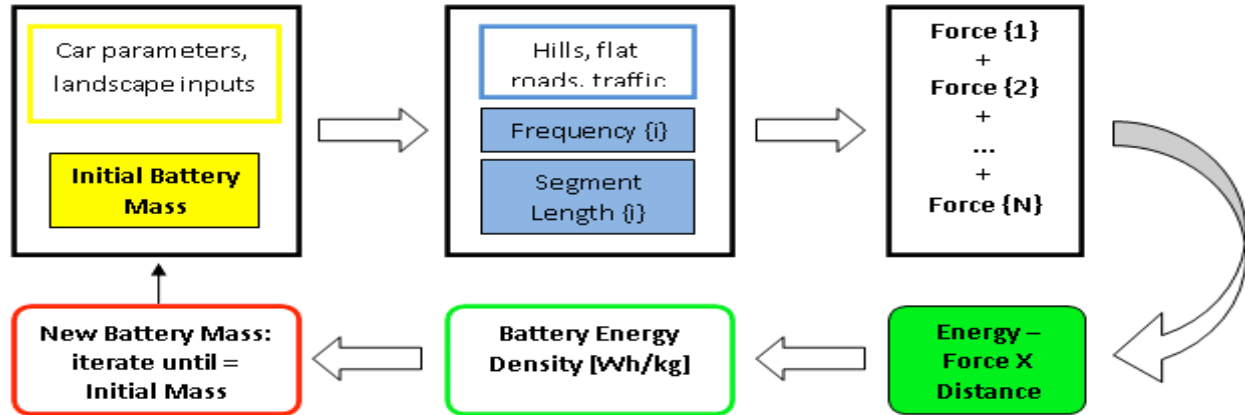

Figure X-3: Battery Weight Algorithm

Governing Equations:

$$E_i = F_i \cdot (d_i \cdot f)$$

$$F_i = \frac{1}{2} \cdot C_d \cdot \rho_{air} \cdot f_{area} \cdot (\alpha \cdot v_{car} + v_{wind})_i^2 + m_{total} \cdot (C_{rr} \cdot g \cdot \cos(\theta_i) + g \cdot \sin(\theta_i) + a_i)$$

$$m_{total} = m_{car} + m_{battery}$$

$$m_{battery} = \frac{\sum E_i}{3600 \cdot \rho_E}$$

Where:

- E_i : energy for given segment [J]
- F_i : force exerted during the segment [N]
- d_i : segment distance[m]
- f : frequency of segment
- C_d : drag coefficient
- ρ_{air} : density of air [kg/m³]
- f_{area} : car max frontal area [m²]
- α : speed multiplier
- v_{car} : speed of car [m/s]
- v_{wind} : speed of head wind [m/s]
- m_{car} : mass of car without battery

- m_{battery} : mass of battery
- C_{TR} : coefficient of rolling friction (tires)
- g : gravity constant [9.81m/s^2]
- θ_i : hill inclination angle [deg]
- a_i : car acceleration speed from rest [m/s^2]
- ρ_E : energy density of battery [Wh/kg]

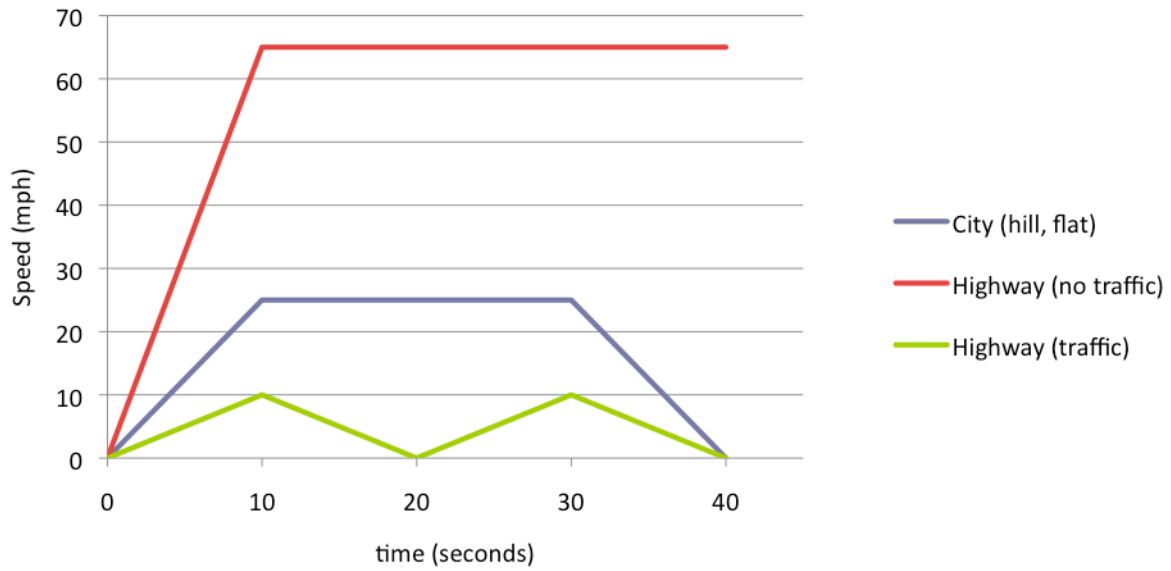
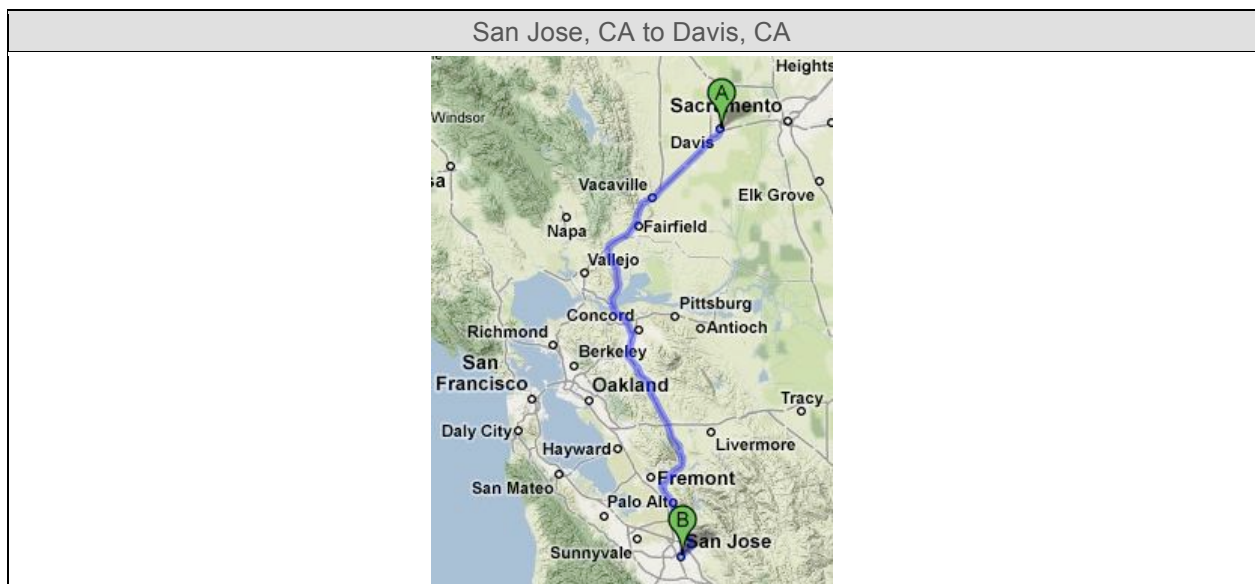

Figure X-4: Example of Driving Speed Profile

Table X-1: Example Model Calculation: Terrain



	Frequency	Segment Length [miles]	Speed [Mph]
City			
Hills	2	1	25
Flat	10	1	30
Highway			
No Traffic	1	83	65
Traffic	500	0.01	15 (max)
Total [miles]: 100			

1.2. Battery Usage Model

This model takes two sets of inputs. The first is the power requirements for a given driving pattern, pictured below in Figure X-5. Also required is the initial battery state-of-charge.

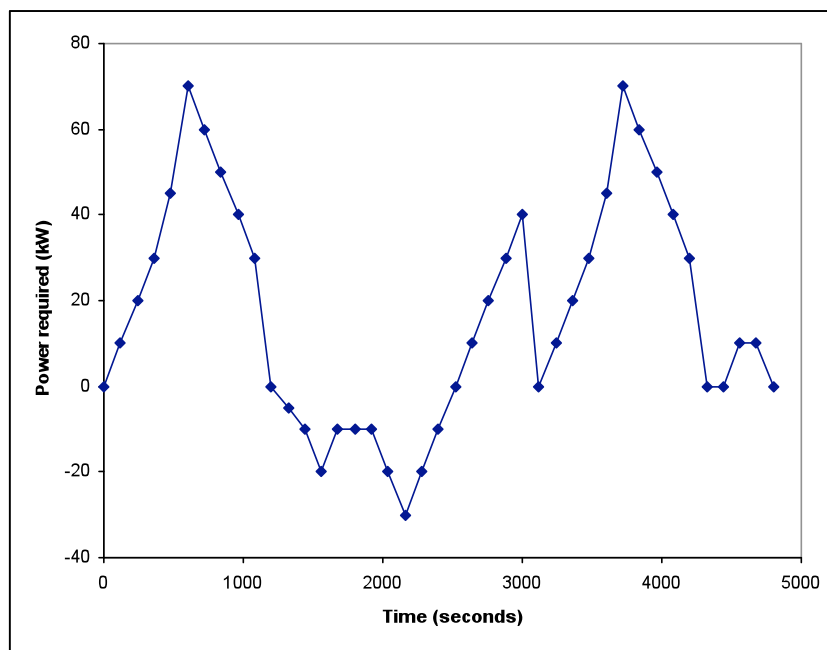

Figure X-5: Sample power vs. time curve for battery usage model. Negative power corresponds to deceleration or braking.

The second set of inputs consists of detailed battery information, such as the maximum and minimum power and current upon charge and discharge, maximum and minimum allowable state-of-charge, size, and weight. Also required are the number of units in series and parallel, and a set of voltage vs. capacity curves for different currents. One set of these curves, for A123's ANR26650 cell,²⁹ is pictured in Figure X-6.

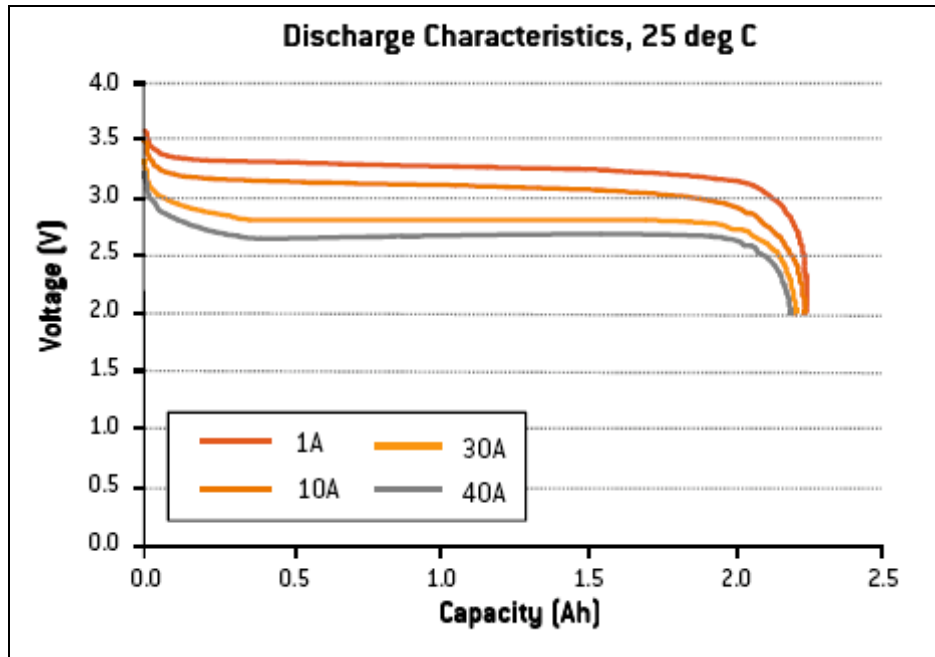

Figure X-6: Voltage vs. capacity on discharge for ANR26650 high-power cell from A123 Systems. Less voltage is obtained at higher currents, creating a nonlinear relationship between power and state of charge.

With these inputs, the model first calculates a series of power versus state-of-charge curves for the battery pack by multiplying the voltage by the number of cells in series, and the current by the number in parallel before multiplying current by voltage to get power. As an example, output pack data is pictured below for the case of fifty ANR26650 cells in series and one hundred in parallel.

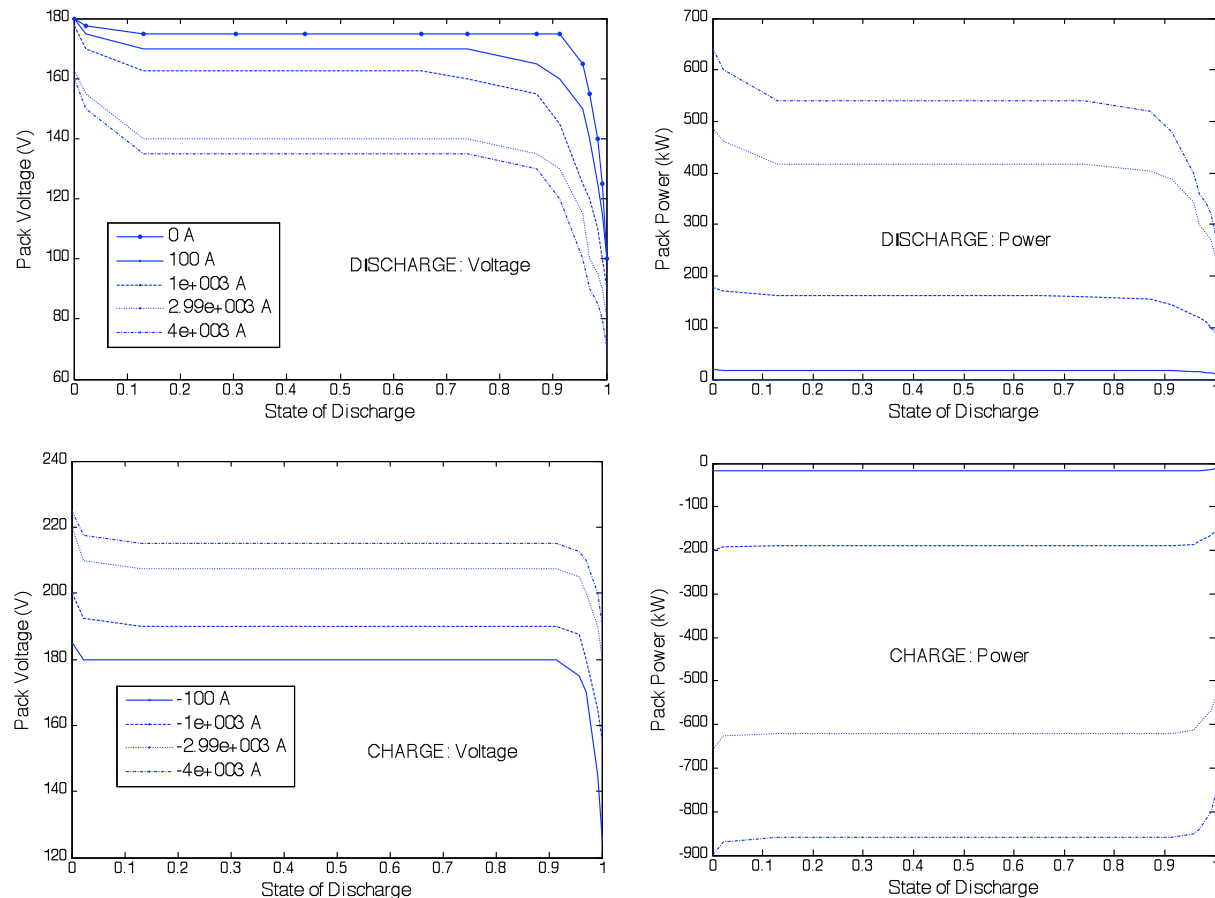

Figure X-7: Pack data for a hypothetical unit built from (50 in series) x (100 in parallel) ANR26650 cells. The curves show how, on discharge, pack voltage decreases with state of charge and higher currents while power decreases with state-of-charge and increases with current. On battery charge (negative current and power), the opposite holds. Symbols are the same on all plots. The zero-current curve is only shown on discharge, not charge.

After generating the pack data, the simulation calculates the current necessary to meet the power requirements at the initial state of charge. It multiplies the required current by the time step in order to determine the amount of charge depleted, updates the state-of-charge, and continues to the next time step. This continues until the driving cycle is finished or the battery has been depleted below its minimum state-of-charge. A sample output for the system described is below. Simulation results show that while maximum current, power, and voltage requirements are satisfied, the battery is limited by capacity and discharges completely before the drive is finished.

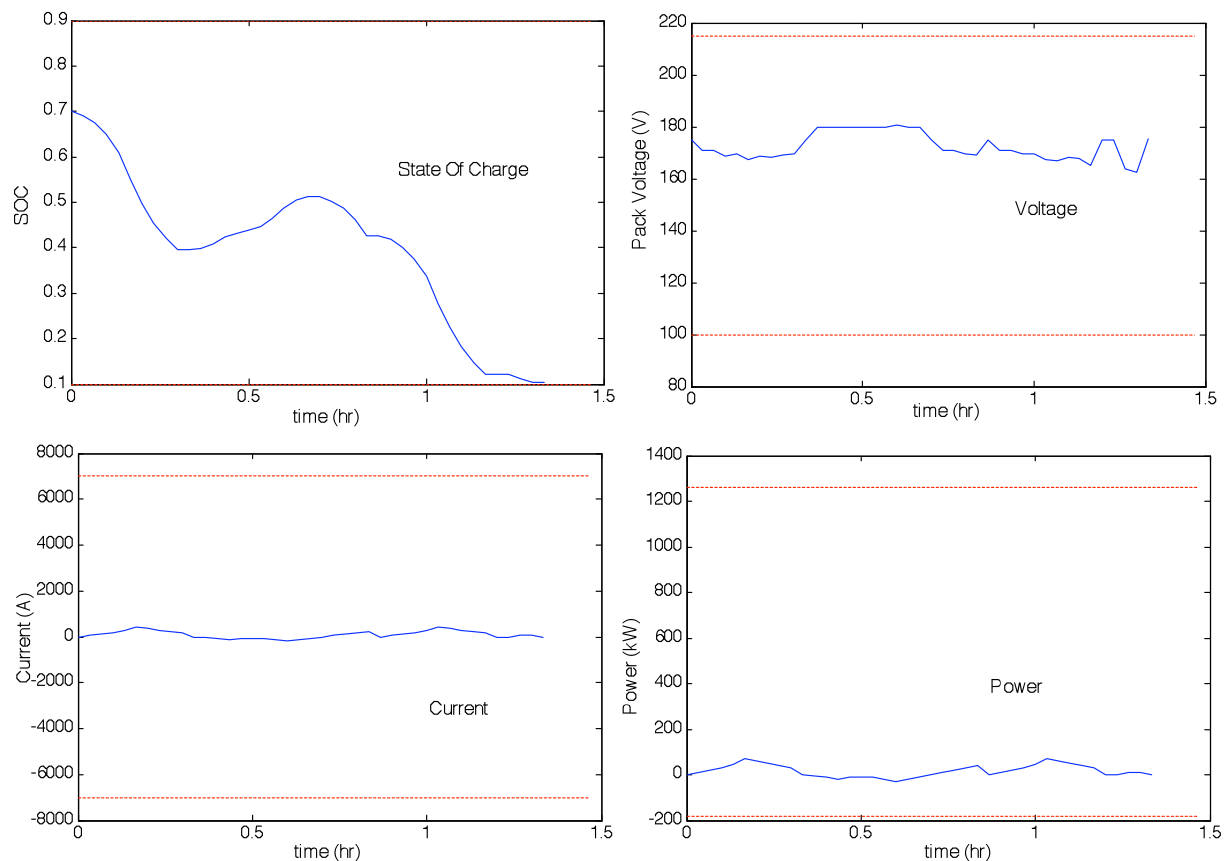

Figure X-8: Battery simulation outputs for the ANR26650 pack and the driving cycle shown in Figs X-6 and X-5. The above plots show that while the maximum voltage (top right), current (bottom left), and power (bottom right) requirements are never exceeded, the battery is depleted before the driving cycle is finished (top left). The state-of-charge increases around 0.6 hours because the negative power requirement (Fig X-5) is captured as regenerative braking.

2. Electricity Cost Tables

Table X-2: Cathode Metal Active Material Cost as of April, 2009

Component	Raw materials cost (\$/kg) [1]	Source
Manganese	2.33	
Iron Phosphate	4.45	[2]
Cobalt	35.32	
Lithium Carbonate	5.50	[3]
Sources :		
[1] www.mineralprices.com		
[2] http://www.exporters.sg/showroom_item.asp?id=381911		
[3] http://www.theaustralian.news.com.au/business/story/0,28124,25123418-18261,00.html		

Table X-3: Average Electricity Cost Rates (Data from 2008–2009) for Commercial Sector

Region	Average Commercial Electricity Rate (/kWh)	Source
California	\$0.12051	[1]
Michigan	\$0.09161	[1]
China	\$0.05252	[2]
Sources:		
[1] http://www.eia.doe.gov/cneaf/electricity/epm/table5_6_a.html		
[2] http://www.chinamining.org/News/2008-01-04/1199417412d8506.html		

Table X-4: Electricity Consumption and Economic Activity for Different Industry Sectors³⁰

Material	Sector	Energy per 1M\$ (MkWh)	Economic Activity per 1M\$ (M\$)
Graphite	Carbon and Graphite Product Mfg	0.955	1.88
Aluminum	Al Sheet, Plate, and Foil Mfg	2.77	2.77
Polymers	Plastics Material and Resin Mfg	0.899	2.78
Iron	Iron Ore Mining	3.72	2.17
Lithium	Stone Mining and Quarrying	0.781	1.87
Phosphorus	Other Basic Inorganic Chemical Mfg	2.43	2.07
Fluorine	Other Basic Inorganic Chemical Mfg	2.43	2.07
Cobalt	Gold, Silver, and Other Metal Ore Mining	1.46	2.05

Table X-5: Cost Teardown for LiCoO₂ and LiFePO₄ for the Major Components Plus Overhead and Labor^{31, 32}

Component	LiCoO ₂ (\$)	LiFePO ₄ (\$)
Cathode	0.751	0.213
Anode	0.24	0.218
Electrolyte	0.296	0.276
Separator	0.156	0.14
Casing	0.23	0.23
Overhead+Labor	0.473	0.473
Total (\$/Cell)	2.146	1.55

Biographies

Justin Amirault is an M.B.A. student at the Haas School of Business at UC Berkeley. Prior to Haas, Justin spent several years focused on cleantech investment banking with early stage companies.

Joshua Chien is a Mechanical Engineering Masters student at UC Berkeley. His interests are in Sustainable Manufacturing and Life Cycle Assessment.

Saurabh Garg is a Mechanical Engineering Ph.D. student at UC Berkeley.

Drew Gibbons is an M.B.A. student at the Haas School of Business at UC Berkeley. Drew's focus at Haas is large-scale clean energy generation and the interaction between public policy and business.

Ben Ross is an Applied Science and Technology Ph.D. student at UC Berkeley. His research focus is in photonics and nanoscale devices.

Maureen Tang is a Chemical Engineering Ph.D. student at UC Berkeley. Her research focuses on overcharge protection of lithium-ion batteries.

Jia Xing is a Chemical Engineering M.S. student at UC Berkeley.

Ikhtlaq Sidhu is the founding director of UC Berkeley's Center for Entrepreneurship & Technology and the "2009 Emerging Area Professor" of Industrial Engineering and Operations Research at UC Berkeley. He is interested in systems and networking applications related to new business opportunities and technology management. Within industry, he held senior executive and technology leadership positions at U.S. Robotics Corporation, 3Com Corporation, and Cambia Networks. He was awarded 3Com's "Inventor of the Year" in 1999, and has been granted over 50 U.S. patents in fundamental and broadly-used areas of networking technology, IP telephony, and PDA functionality.

Phil Kaminsky is an associate professor in the Industrial Engineering and Operations Research Department at UC Berkeley. His current research focuses on the analysis and development of robust and efficient techniques for the design and operation of logistics systems and supply chains. He is a co-author of "Designing and Managing the Supply Chain: Concepts, Strategies and Case Studies" (McGraw-Hill, 1999, 2003), which won the Book-of-the-Year Award and Outstanding IIE Publication Award in 2000, and is co-author of "Managing the Supply Chain: The Definitive Guide for the Business Professional" (McGraw-Hill, 2004).

Burghardt Tenderich is the Executive Director of the Center for Entrepreneurship & Technology and a lecturer on entrepreneurship. Dr. Tenderich brings to the Center over 18 years experience in marketing and communications in the information technology and internet industries. He is a Founding Partner of TnT Initiatives, LLC, a social media publishing and consulting firm focusing on web and healthcare-related technologies. Previous positions have included General Manager, North America, for technology communications consultancy Bite Communications, Vice President, Public Relations at Siebel Systems, and Senior Vice President & Partner in the technology PR agency

Applied Communications. Dr. Tenderich holds an M.A. and a Ph.D. in Economic Geography from the University of Bonn, Germany.

About UC Berkeley Center for Entrepreneurship & Technology

The Center for Entrepreneurship & Technology (CET) seeks to foster entrepreneurship within the university and to bring Berkeley's research capability to industry collaborations. To these ends, the CET hosts multi-disciplinary research projects in collaboration with industry stakeholders; as well as provides mentoring and support to new Berkeley ventures.